



FABRICANT DE SÉCURITÉ DEPUIS 1920

CATALO GUE

CATALOG
CATÁLOGO
2023





SAS THIRARD
45, rue Jean Jaurès - CS 60004
80390 Fressenneville Cedex France
Tél: +33 (0)3 22 60 26 50
Fax: +33 (0)3 22 30 31 13
Email : commercial@thirard.fr

sommaire

table of contents / resumen



Edito / <i>Editorial</i> / Editorial	6	Serrures à appliquer <i>Rom locks</i> / Cerradura en applique	766
Organisation / <i>organization</i> / organización	9	Serrures de meuble <i>Furnishing door</i> / Puerta de muebles	902
Structure de l'offre / <i>Structure of the offer</i> / Estructura de la oferta	10	Coffres forts <i>Safe box</i> / Caja fuerte	910
Zones géographiques / <i>areas</i> / áreas	12	Poignées <i>Handles</i> / Picaporte	930
GSB/GSA <i>DIY stores</i> / Gran espacio de bricolaje Le concept PLANÈTE Data Design Merchandising	14	Gamme Serrurerie de Picardie <i>Serrurerie de Picardie range</i> / Gama Serrurerie de Picardie	1038
GSB/GSA Premier prix <i>low price</i> / Primer precio Lancement de SP	20	Gamme SERRUPRIX <i>SERRUPRIX</i> / SERRUPRIX	1051
Marchés pro / <i>professional markets</i> / mercados profesionales	22	Clés de rechange <i>Keys</i> / Llaves	1057
Digital Thirard Ossito Web	26	Abréviations <i>Abbreviations</i> / Abreviaturas	
Les produits <i>Products</i> / Productos		Conditions générales de vente	
Controle d'accès <i>Access control</i> / Control de acceso	30		
Cadenas <i>Padlocks</i> / Candados	42		
Consignation <i>Lockout</i> / Bloqueo	174		
Sandows <i>Sandows</i> / Sandow	248		
Équipement de porte <i>Door locks</i> / Equipamientos de puerta	270		
Verrous <i>Blots</i> / Cerraduras	358		
Cylindres <i>Cylinders</i> / Cilindros	472		
Batteuses <i>Cam locks</i> / Cerradura con leva	574		
Serrures à encastrer <i>Mortise locks</i> / Cerradura empotrable	590		

2023 : une année de transition

Les efforts soutenus depuis des années permettent à l'entreprise THIRARD de réaliser les transformations nécessaires et de poursuivre son développement.

Certes, en 2023, la récession menace en Europe, les coûts énergétiques pèsent sur nos entreprises, l'Euro est dévalué et l'inflation est toujours là... Mais THIRARD s'est mobilisé pour surmonter ces difficultés. L'entreprise a tous les atouts pour prendre des parts de marché et se développer sur de multiples secteurs économiques et géographiques.

Sur le plan industriel, les stocks des matières premières et de produits finis sont au maximum et tous les investissements prévus ont été réalisés. (Une machine transfert, deux tours d'usinage et 10 robots de polissage, acquis récemment, sont en fonctionnement). La logistique gagne également en capacité grâce à une extension de 1000m².

Du point de vue des ressources humaines, les effectifs sont complets. L'équipe marketing renforcée permet à THIRARD de construire, structurer et déployer son offre. Les équipes commerciales, organisées et puissantes, sont en ordre de marche pour gagner des marchés en Europe et dans le Monde.

Les gammes de produits THIRARD s'enrichissent de nombreuses nouveautés. Les produits intelligents Intelock, les évolutions de cylindres (HG5+, Transit2, Cobra2+...) le nouveau cylindre modulaire Dreamer, un système complet de signalétique et une nouvelle collection de poignées constituent notamment les nouveautés 2023. Le nouveau système de Centre Service vient compléter également l'offre THIRARD.

En parallèle de ces nouveautés, THIRARD est heureux d'annoncer le lancement de FTH ! Créée en 1920, cette marque historique, 100% made in France, est de retour. Constitué de cadenas, verrous, cylindre et serrures « iconiques » de qualité, ce cœur de gamme va battre à nouveau !

THIRARD est désormais certifié ISO 14001 et 45001. Prochain objectif : La certification ISO 26000 et la reconnaissance Ecovadis OR, selon un plan à 3 ans. Le déploiement de la politique RSE se poursuit et s'intensifie. L'entreprise THIRARD s'engage d'ailleurs dans un plan d'économie, principalement sur ses dépenses énergétiques, avec un objectif affirmé de sobriété.

Enfin, 2023 est l'année de l'aboutissement du Concept Planète, lancé il y a 3 ans. Il s'agit d'un travail de transformation des emballages, conformément aux critères de la loi Agec. Ce nouveau cadre légal a été l'occasion de repenser complètement le packaging THIRARD selon deux axes :

- La rationalisation, avec des emballages plus légers et adaptés aux canaux de vente
- Le marketing, avec une nouvelle charte graphique et un merchandising optimisé.

THIRARD dispose des ressources, des moyens, des compétences et d'une volonté affirmée pour faire de 2023 l'année de la transition !

2023: a transition year

Sustained efforts over the years have enabled the company THIRARD to carry out the necessary transformations and to follow its development.

In 2023, the recession threatens in Europe, energy costs weigh on our companies, the Euro is devalued, and inflation is still there. But THIRARD is mobilized to overcome these difficulties. The company has all the assets to take market share and develop on multiple economic and geographical sectors.

At the industrial level, the stocks of raw materials and finished products are at their maximum and all planned investments have been made. (A transfer machine, two machining lathes and 10 polishing robots, acquired recently are in operation). The logistic department is also winning in capacity thanks to an extension of 1000 m².

From the point of view of human resources, the workforce is complete. The reinforced marketing team allows THIRARD to build, structure, and spread out his offer. The sales teams organized and powerful are in working order to win markets in Europe and around the world.

The range of products THIRARD enrich with a lot of news products. The smart products Intelock, the evolution of cylinder (HG5+, Transit 2, Cobra 2+ ...), the new modular cylinder Dreamer, a full system of signs and a new collection of handles make up the news of 2023. The new system of Centre Service completes also the THIRARD offer.

In parallel of these new features, THIRARD is pleased to announce the launch of FTH ! Created in 1920, this historic brand, 100 % made in France, is back. Made up of quality and iconic padlocks, bolts, cylinders and mortise locks, this core range will live again.

THIRARD is now ISO 14001 and 45001 certified. Next objective: ISO 26000 certifications and Ecovadis GOLD recognition, according to a 3- year plan. The deployment of the CSR policy continues and intensifies. THIRARD company is also committed to a saving plan, mainly on its energy expenditures, with a stated objective of sobriety.

Finally, 2023 is the year of the culmination of the Planet Concept, launched 3 years ago. This is a packaging transformation work according to the criteria of AGECE Law. This new legal framework was an opportunity to completely rethink the THIRARD packaging along two lines:

- *Rationalization, with lighter packaging adapted to sales channels*
- *Marketing, with a new graphic charter and optimized merchandising.*

THIRARD has the resources, means, skills and a strong desire to make 2023 the year of transition!

2023 : un año de transición

Los esfuerzos sostenidos desde años han permitido a la empresa THIRARD de llevar a cabo las transformaciones necesarias y seguir su desarrollo.

En 2023, la recesión amenaza en Europa y los costos de la energía pesan sobre nuestras empresas, el euro se devalúa y la inflación sigue. Pero THIRARD se movilizó para vencer esas dificultades. La empresa tiene todas las ventajas para tener cuota de mercado y desarrollarse en múltiples sectores económicos y geográficos.

Industrialmente, el inventario de materias primas y de productos finales están al máximo y todas las inversiones previstas han sido ejecutados. (Una máquina transfer, dos tornos de mecanizado y 10 robos pulidores, adquiridos recientemente, están funcionando). La logística también gana en capacidad gracias a una extensión de 1000m².

Desde el punto de vista de los recursos humanos, la plantilla es completa. El equipo Marketing reforzado permite a THIRARD de construir, estructurar y desplegar su oferta. Los equipos de ventas, organizados y poderosos están en condiciones de ganar mercados en Europa y en el resto del mundo.

Las gamas de productos THIRARD se han enriquecido con muchos nuevos productos. Los productos inteligentes Intelock, las actualizaciones de cilindros (HG5+, Transit 2, Cobra 2+, etc), el nuevo cilindro modular Dreamer, un sistema completo de señalización y una nueva colección de manillas son, en particular, las novedades para 2023. El nuevo sistema de centro servicio también completa la oferta THIRARD.

En paralelo, THIRARD es feliz de anunciar el lanzamiento de FTH. Creado en 1920, esta marca historia, 100% fabricado en Francia, está de vuelta. Constituido de candados, cerrojos, cilindros y cerraduras icónicas de calidad, esta gama de productos volverá a vivir.

THIRARD es ahora certificado ISO 14001 y 45001. El próximo objetivo es la certificación ISO 26000 y el reconocimiento ECOVADIS OJO según un plazo de 3 años. La ejecución de la política RSE continua y se intensifica.



La empresa THIRARD realiza un plan de ahorro, principalmente en sus gastos energéticos, con un objetivo declarado de sobriedad.

En 2023, es el año de la culminación del concepto Planeta, lanzado hace 3 años. Se trata de un trabajo de transformación de embalajes, de acuerdo con los criterios de la ley AGECE. Es un nuevo marco legal que fue una oportunidad para repensar por completo el embalaje THIRARD según 2 ejes:

- La racionalización, con embalajes más ligeros y adecuados a los canales de ventas.
- El marketing, con una nueva carta gráfica y una comercialización optimizada.

THIRARD tiene todos los recursos, de los medios, de las competencias y de una voluntad afirmada para hacer del año 2023, el año de la transición !

Barnabé Chivot

Président
President
Presidente



organisation

organization / organización

Pour répondre efficacement aux besoins de chacun de ses clients, Thirard est organisé en 4 pôles :

- Un service dédié à la distribution spécialisée, constitué d'une équipe de 90 commerciaux
- Un service industrie dédié aux intégrateurs de solutions mécaniques de fermeture
- Un service export dédié aux marchés européens, et mondiaux
- Un pôle e-commerce.

L'entreprise Thirard possède une organisation industrielle et logistique puissante qui garantit la production et la livraison de produits de qualité dans des délais optimaux.

To effectively meet each customer's needs, Thirard is organized in 4 departments :

- *A department dedicated to specialized distribution, comprised of a team of 90 sales representatives*
- *An industry department dedicated to closing mechanical solutions integrators*
- *An export department dedicated to European and Global markets*
- *E-commerce pole*

Thirard company has a powerful industrial and logistic organization which guarantees production and delivery of quality products in an optimum lead-time.

Para responder con eficacia a las necesidades de cada uno de sus clientes, Thirard está organizado en 4 áreas:

- Un servicio dedicado a la distribución especializada, formado por un equipo de 90 comerciales.
- Un servicio industrial dedicado a integradores de soluciones del cierre mecánico.

- Un servicio de exportación dedicado a los mercados europeos y globales.
- División de comercio electrónico

Thirard tiene una poderosa organización industrial y logística que garantiza la producción y entrega de productos de calidad en el tiempo óptimo .

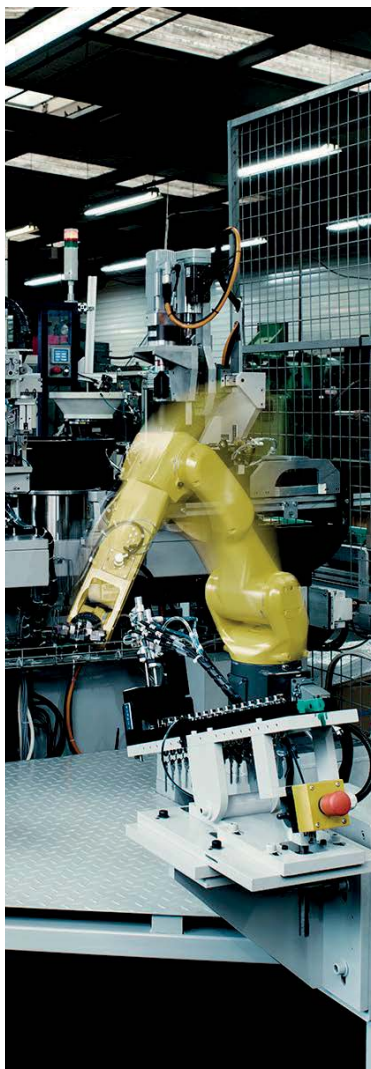

Thirard, leader en France dans la distribution spécialisée de quincaillerie serrurerie, propose une offre structurée en 4 canaux :

- la **GSB/GSA** avec des implantations Thirard et SP
- le **négoce matériaux**, avec des gammes Thirard en conditionnement spécifiques Pro
- la **quincaillerie bâtiment**, avec des gammes Thirard en conditionnement Pro
- la **fourniture industrielle** avec des solutions d'équipement de fermeture et de contrôle d'accès.

Une force de vente est au service de chaque canal de distribution.

THIRARD, the French leader in the specialized distribution of hardware, offers a range of products and services through 4 channels:

- **DIY stores and Food superstores** with THIRARD and SP layouts
- **Material Trade** with THIRARD ranges in specific Professional packaging
- **Hardware building** with THIRARD ranges in professional packaging
- **Industrial supply** with door fittings and access control solutions

A sales force is dedicated to each distribution channel.

THIRARD, líder en Francia en la distribución especializada de ferretería y cerrajería, ofrece una oferta estructurada en 4 canales:

- **Espacios de bricolajes y supermercados de alimentos** con espacio de estantería THIRARD y SP
- **Almacenes de materiales** con gamas THIRARD en un embalaje específico para los profesionales
- **Ferretería de la construcción**, con las gamas THIRARD en un embalaje por los profesionales
- **Suministro industrial** y soluciones de control de acceso.

Una fuerza de ventas esta al servicio de cada canal de distribución

4 canaux

structure de l'offre

offer structure / estructura de la oferta

GRANDE SURFACE BRICOLAGE
ET ALIMENTAIRE



NÉGOCE MATÉRIAUX



QUINCAILLERIE BÂTIMENT



FOURNITURE INDUSTRIELLE



zones géographiques

areas / áreas

ZONE 1

Royaume Uni / United Kingdom
Ukraine / Ukraine
Pologne / Poland
Slovaquie / Slovakia
Estonie / Estonia
Lituanie / Lithuania
Lettonie / Latvia

ZONE 2

Roumanie / Romania
Hongrie / Hungary
Bulgarie / Bulgaria
Croatie / Croatia
Serbie / Serbia
Albanie / Albania
Royaume Uni / United Kingdom

ZONE 3

Allemagne / Germany
Espagne / Spain
Italie / Italy
Grèce / Greece
Portugal / Portugal
République Tchèque / Czech
Republic
Pays bas / Netherland
Royaume Uni / United Kingdom

ZONE 4

Suède / Sweden
Norvège / Norway
Finlande / Finland
Danemark / Danemark

ZONE 5

Australie / Australia
Chine / China
HongKong / HongKong
États Unis / USA

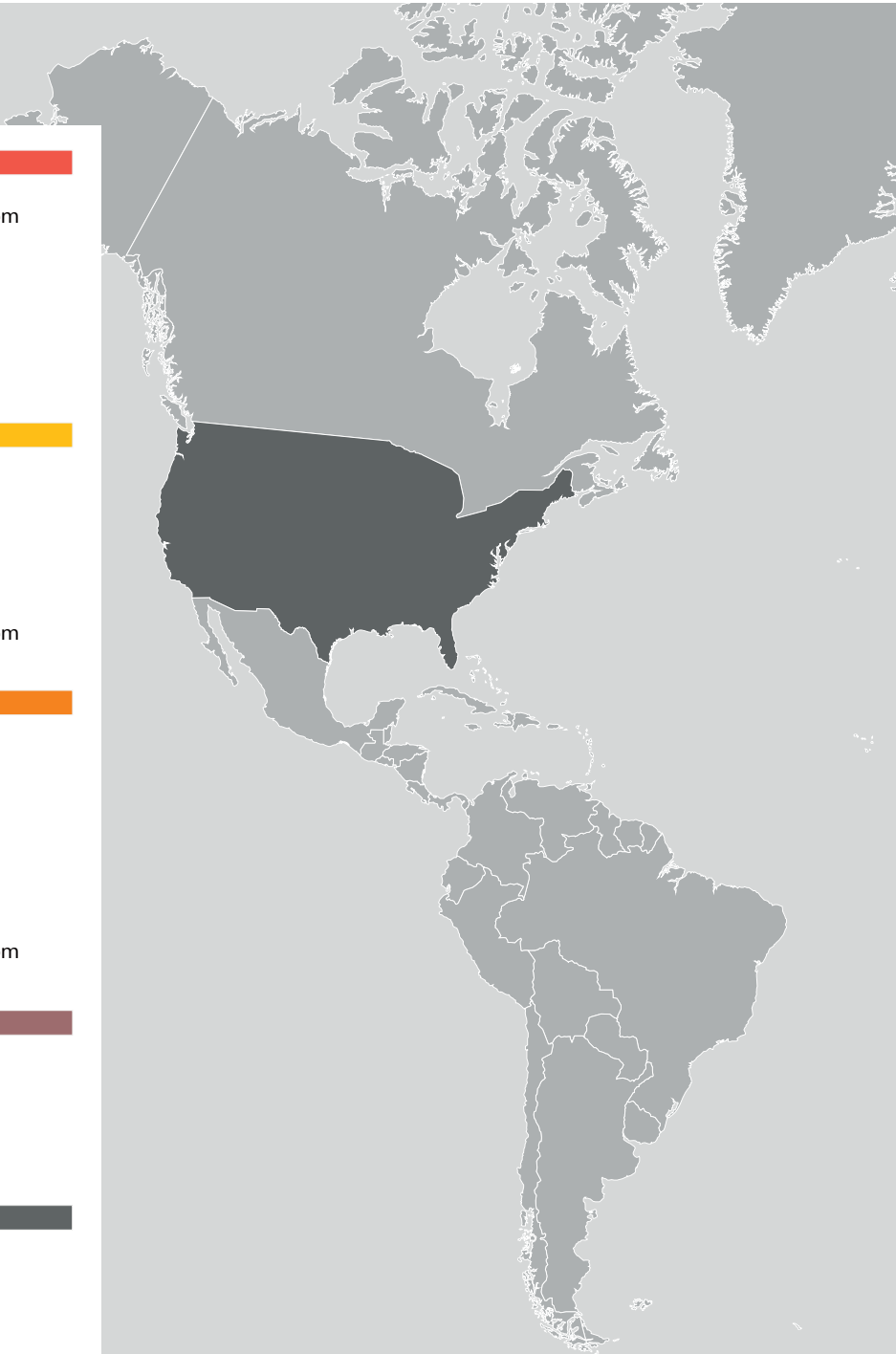

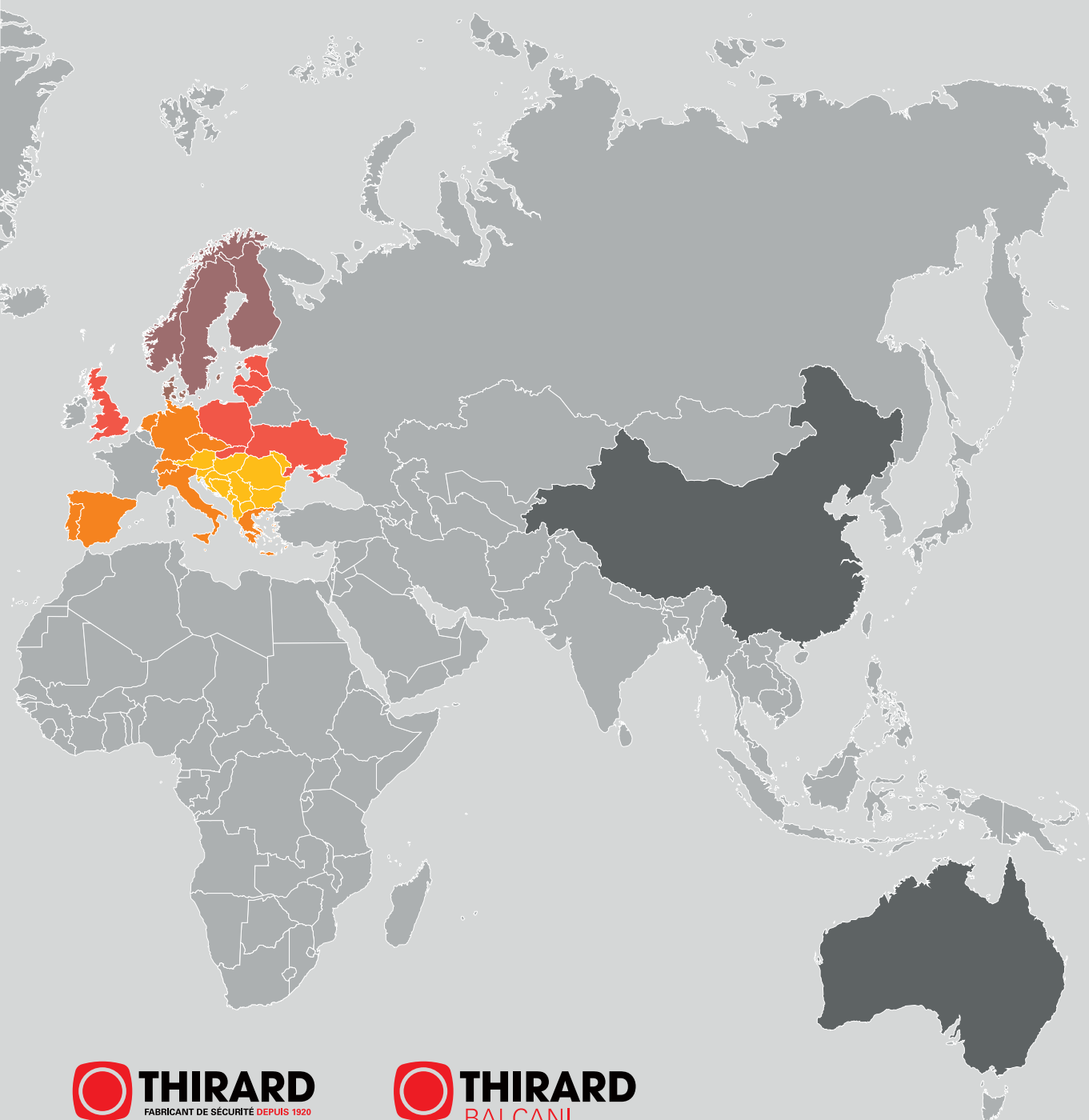

 **THIRARD**
FABRICANT DE SÉCURITÉ DEPUIS 1920

 **THIRARD**
BALCANI

 **THIRARD**
POLSKA

 **THIRARD**
ASIA

Transition et révolution : le concept PLANÈTE

Les contraintes réglementaires de la loi AGEC concernant les emballages ont poussé les équipes THIRARD à repenser complètement les packagings selon deux axes :

- La rationalisation avec un travail sur la structure des gammes et le développement de nouveaux conditionnements, plus légers, adaptés aux canaux de vente.
- Le marketing avec une nouvelle charte graphique et un merchandising optimisé.

Lancé en 2022, le programme a abouti à un concept phygital comportant une extension d'offre sur le web et un concept sur mesure modulaire en espace de vente. L'objectif final est la suppression du plastique à usage unique, 60% de nos emballages ont été redéfinis et sont déjà compatibles AGEC, les équipes continuent de travailler pour apporter une réponse totale.

Une part croissante des consommateurs effectuent une recherche préalable sur le web avant leur achat en magasin. L'espace de vente devient un lieu de « transformation » du processus d'acquisition d'un produit. En complément du packaging, les informations sur le lieu de vente et les conseils des professionnels sont déterminants dans la finalisation de l'achat. Le rôle du conseiller de vente prend tout son sens dans cette combinaison phygitale.

The regulatory constraints of the AGEC law concerning the packaging prompted the THIRARD's Teams to completely rethink the packaging along two lines:

- *A Rationalization with work on the structure of the ranges and the development of new packaging, lighter, adapted to the sales channels.*
- *Marketing with a new graphic charter and optimized merchandising.*

Launched in 2022, the program resulted in a "phygital" concept comprising an extension of the offer on the web and modular tailor-made concept in the DIY stores. The final objective is the elimination of single use plastic, 60% of our packaging has been redefined and is already AGEC compatible, the teams continue to work to provide a total response.

A growing share of consumers do research on the web before making a purchase in store. The DIY Stores becomes a place of "transformation" of the process of acquiring a product. In addition to the packaging, information on the point of sale and advice from professionals are decisive in finalizing the purchase. The role of the sales consultant takes on its full meaning in this "phygital" combination.

Las limitaciones reglamentarias de la ley AGEC en materia de embalajes llevaron a los equipos de THIRARD a repensar completamente el embalaje en dos líneas:

- La Racionalización con una nueva definición de la estructura de las gamas y del desarrollo de los nuevos embalajes, mas ligeros y adaptados a los canales de venta.
- El Marketing con una nueva carta grafica y un merchandising optimizado.

Iniciado en 2022, el programa resultó en un concepto "phygital" que comprende una extensión de la oferta en la web y un concepto modular a medida en los espacios de venta. El objetivo final es la eliminación del plástico de un solo uso, el 60% de nuestros embalajes se han redefinido y ya son compatibles con AGEC, los equipos siguen trabajando para dar una respuesta total.

Una proporción cada vez mayor de consumidores investiga en la web antes de realizar una compra en la tienda. El espacio de venta se convierte en un lugar de "transformación" del proceso de adquisición de un producto. Además del embalaje, la información en el punto de venta y el asesoramiento de profesionales son determinantes a la hora de finalizar la compra. El papel del consultor de ventas adquiere todo su significado en esta combinación "phygital".



Plus d'info !

Fiche produit
avec description et
caractéristiques

Tuto et astuces
en image

Notice d'installation
sous format vidéo

SUPER FACILE 



UN TOURNEVIS SUFFIT



Boitier de serrure universelle axe et entraxe réglable réversible

Coffre de 144 x93mm en acier cambré. Peinture époxy noir granité. Pêne dormant en acier nickelé, Pêne demi tour en zamak nickelé. Fouillot carré 7mm en zamak. Axe réglable de 50 à 60 mm. Entraxe réglable de 108 à 120 mm. Cabochon CP et fouillot en polyamide noir. Plaque Support de fixation en acier galvanisé. Cette serrure s'adapte au sens de porte (Droite / Gauche / Tirant / Poussant).



Capacité de réglage de l'axe du cylindre (de 50 à 60mm) et de l'entraxe du fouillot (de 108 à 120mm)



gsb/gsa *DIY stores /* gran espacio de bricolaje

1

Marque



2

Segmentation



Cadenas 40mm



Plus d'infos !



3

Informations

Plus clair, plus moderne, plus impactant !

La nouvelle charte graphique des emballages THIRARD est l'aboutissement d'un long travail de maturation, sur la base du système précédent. Tout a été repensé pour gagner en lisibilité, en simplicité, en efficacité... et donc en impact en linéaire.

Le premier objectif a été de renforcer la marque en adoptant un bandeau rouge en partie haute des emballages. Ce principe apporte en plus une cohérence avec l'ensemble de la communication THIRARD.

Le nouveau design du système de segmentation, plus compact, regroupe la gamme du produit et le niveau de sécurité. La lecture est plus simple et immédiate.

Les pictogrammes de caractéristiques produit et d'usage ont été modernisés et regroupés sur la droite, en 3^{ème} niveau de lecture. Un QR code a été ajouté. Il permet un lien direct vers la fiche produit.

Toutes ces évolutions sur la structure et le design améliorent la présence de la marque en magasin et son potentiel de séduction.

The new graphic charter of THIRARD packaging is the result of a long maturation process, based on the previous system. Everything has been rethought to improve readability, simplicity, efficiency and therefore impact on the self.

The first objective was to reinforce the brand by adapting a red band at the top of the packaging. This principle also brings coherence with THIRARD's communications.

The new design of the segmentation system, more compact, groups the product range and the level of safety. It's easier and more immediate to read.

The products characteristics and usage pictograms have been modernized and grouped together on the right, in the third reading level. A QR code has been added. It allows a direct link to the product sheet.

All these evolutions on the structure and the design improve the presence of the brand in store and its potential of seduction.

La nueva carta grafica de los embalajes THIRARD es el resultado de un largo proceso de maduración, basado en el sistema anterior.

Todo se ha repensado para mejorar la legibilidad, la sencillez y la eficacia y por tanto un impacto en el lineal.

El primer objetivo era reforzar la marca adoptando una banda roja en la parte superior del embalaje. Este principio también aporta coherencia al conjunto de la comunicación de THIRARD.

El nuevo diseño del sistema de segmentación, más compacto, agrupa la gama de productos y el nivel de seguridad. La lectura es más fácil e inmediata.

Los pictogramas de las características y el uso de los productos se han modernizado y agrupado a la derecha, en el tercer nivel de lectura. Se ha añadido un código QR para permitir un enlace directo a la ficha de producto.

Todos estos cambios en la estructura y el diseño mejoran la presencia de la marca en la tienda y su potencial para atraer a los clientes.



Un merchandising à la mesure des besoins de la distribution !

THIRARD accompagne ses clients pour une implantation réussie en espace de vente.

THIRARD accompanies its consumers for a successful display layout in the DIY Stores.

THIRARD acompaña a sus clientes para un establecimiento exitoso en el espacio de ventas.

Nos équipes ont conçu un dispositif pour gagner en efficacité et guider le consommateur.

Our teams have designed a device to increase efficiency and lead the consumer.

Nuestros equipos han diseñado un dispositivo para aumentar la eficiencia y orientar al consumidor.

- Marques ombrelles
- Implantations verticales pour une montée en gamme
- QR code sur le packaging
- Kit signalétique
- Concept sur mesure

- *Umbrella brands*
- *Vertical layouts for a move upmarket*
- *QR code on the packaging*
- *Signage kit*
- *Tailor made concept*

- Marcas parapluas
- Diseños verticales para un aumento de gama
- Código QR en el embalaje
- Kit de señalización
- Concepto a medida

De plus, nous apportons notre expertise digitale et nos préconisations e-merchandising pour enrichir les sites web de nos distributeurs et ainsi optimiser l'expérience client.

In addition, we bring our digital expertise and our e-merchandising recommendations to enrich the websites of our distributors and thus optimize the customer experience.

Además, aportamos nuestra experiencia digital y nuestras recomendaciones de e-merchandising para enriquecer los sitios web de nuestros distribuidores y así optimizar la experiencia del cliente.

RESIST

PROTECT

ECO

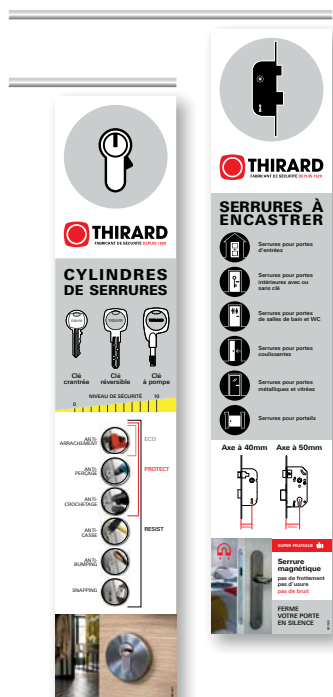

Exemple de Cross selling

gsb/gsa *DIY stores /* gran espacio de bricolaje



THIRARD annonce le lancement de sa nouvelle marque premier prix SP.

Simple, impactante, colorée, cette nouvelle marque SP sera proposée à la fois en GSB et en GSA. Son principe graphique essentiellement visuel, complété par des informations multilingues au dos destine également ces gammes à une distribution internationale.

THIRARD announces the launch of its new premium brand SP.

Simple, impactful, and colorful, this new SP brand will be offered in DIY stores. Its essentially visual graphic principle, completed by multilingual information on the back, is also intended for international distribution.

THIRARD anuncia el lanzamiento de su nueva marca premium SP.

Sencilla, llamativa y colorida, esta nueva marca de SP se ofrecerá tanto en espacios de bricolaje como en gran almacén de alimentos. Su principio gráfico, esencialmente visual, complementado con información multilingüe en el reverso, está pensado también para la distribución internacional.

SP.



gsb/gsa Premier prix

low price / Premier prix

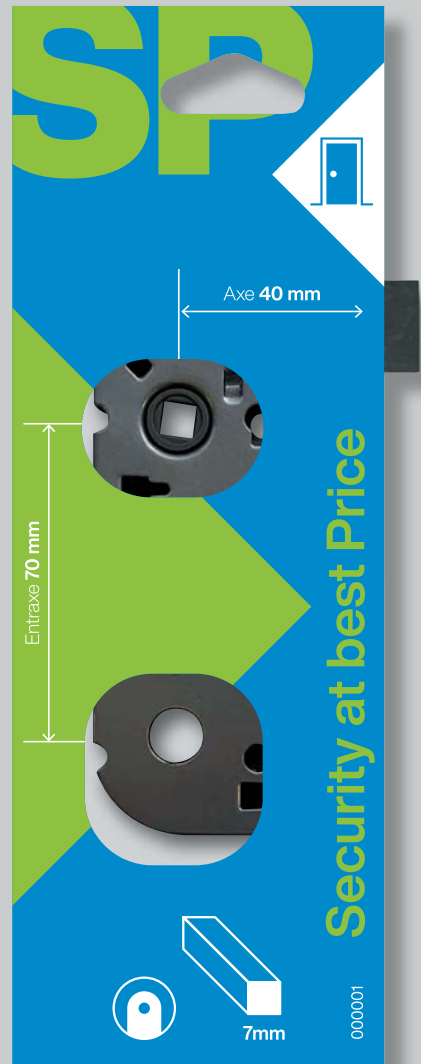

marchés pro

professional markets / mercados profesionales



Présent sur les marchés professionnels de la quincaillerie bâtiment et du négoce matériaux depuis plus de 35 ans, Thirard poursuit sa progression et consolide son action sur ce secteur.

L'organisation des équipes spécialisées a été repensée pour être au plus proche des attentes clients. La direction, accompagnée d'un chef des ventes et d'un pôle formation, pilote une force de vente composée de plus de 15 personnes.

Ces équipes dédiées accompagnent les clients sur le suivi des dossiers, les relevés d'organigrammes et la prescription. La qualité d'écoute client, maître-mot du secteur Thirard pro, combinée au savoir-faire technique, permet, de plus, le développement de produits de fabrication spéciale, sur mesure.

L'ensemble de la force de vente Thirard est à la disposition des clients, notamment les vendeurs, pour de la formation en serrurerie quincaillerie.

THIRARD développe son offre pro avec le nouveau système de Centre Service, et une gamme complète de consignment. Thirard renforce également son offre de contrôle d'accès avec notamment la gamme Intelock.

Active on professional markets of hardware building and wholesale material trading for more than 35 years, Thirard pursues its progression and strengthens its action in this sector.

The organization of the specialized team has been rethought in order to be as close to the customer's needs as possible.

The Management, along with a Sales Manager and a Training department, manage a sales force consisting of more than 15 persons.

Thirard au service des pros

These dedicated teams support customers for the files follow-up, master key systems, and prescription. Customer quality listening, key word in Thirard PRO sector, combined to technical know-how, also encourage development of tailor-made products (specific manufacture).

The whole Thirard sales force is at the customer's service, more particularly at the vendors', for locksmith hardware training.

THIRARD develops its professional offer with the system of center service and a complete range of lockout. THIRARD also strengthens its offer of access control with the Intelock range.

Presente en los mercados profesionales de ferretería y construcción durante más de 35 años, Thirard continúa creciendo y consolida su acción en este sector.

La organización de equipos especializados se ha rediseñado para estar más cerca de las expectativas de los clientes. La gerencia, acompañada por un jefe de ventas y un centro de formación con una fuerza de ventas de más de 15 personas.

Estos equipos ayudan a los clientes en el seguimiento de dosieres, amaestramientos y prescripción. La calidad de la escucha del cliente, la palabra clave del sector profesional de Thirard, combinada con el know-how técnico, permite, además, el desarrollo de productos de fabricación especiales, hechos a medida.

La totalidad de la fuerza de ventas de Thirard está disponible para los clientes, incluidos los vendedores, para capacitarse en la cerrajería.

THIRARD desarrolla su oferta profesional con el nuevo sistema centro servicio y una gama completa de sistemas de bloqueo. Thirard también refuerza su oferta de control de acceso con la gama Intelock.



THIRARD a développé de manière importante son offre pour les professionnels. Une nouvelle gamme de produits de contrôle d'accès Intelock est proposée. Elle comprend un modèle dédié à l'hôtellerie (Intellock Room), un modèle polyvalent (Intellock Multi) et un contrôleur d'accès pour les portes principales (Intellock Gate). Une serrure électronique (Intellock Box), vient compléter cette gamme intelligente.

THIRARD lance également son offre de Centre Service, avec les modèles de cylindres HG5, HG5+, Transit 1, Transit 2 et Cobra (2 et 2+).

Et enfin une offre extrêmement complète de produits de consignation est désormais proposée pour les professionnels.

Les gammes des produits THIRARD couvrent l'intégralité des besoins professionnels (bois et métal). Ces produits de nos usines, sont conformes aux normes : CE, NF (et NFQC), EN 1303 et répondent aux exigences des labels d'assurances A2p.

THIRARD has significantly developed its offer for professionals. A new range of Intellock access control products is proposed. It includes a model dedicated to the hotel industry (Intellock Room), a multi-purpose model (Intellock Multi) and an access controller for main doors (Intellock Gate). An electronic lock (Intellock Box) completes this intelligent range.

THIRARD also launches its Service Center offer, with the HG5, HG5+, Transit 1, Transit 2 and Cobra (2 and 2+) cylinder models.

And finally, an extremely complete range of lockout products is now available for professionals.

The THIRARD product ranges cover all professional needs (wood and metal). These products from our factories comply with the following standards: CE, NF (and NFQC), EN 1303 and meet the requirements of the A2p insurance labels.

THIRARD ha desarrollado significativamente su oferta para profesionales. Se propone una nueva gama de productos de control de acceso Intelock. Incluye un modelo dedicado a la industria hotelera (Intellock Room), un modelo polivalente (Intellock Multi) y un controlador de acceso para puertas principales (Intellock Gate). Una cerradura electrónica (Intellock Box) completa esta gama inteligente.

THIRARD también lanza su oferta para centros de servicio, con los modelos de cilindros HG5, HG5+, Transit 1, Transit 2 y Cobra (2 y 2+).

Y, por último, ya está disponible una gama muy completa de productos de bloqueo para los profesionales.

Las gamas de productos THIRARD cubren todas las necesidades profesionales (madera y metal). Estos productos de nuestras fábricas cumplen las siguientes normas: CE, NF (y NFQC), EN 1303 y cumplen los requisitos de las etiquetas de seguro A2p.



marchés pro

professional markets / mercados profesionales



digital

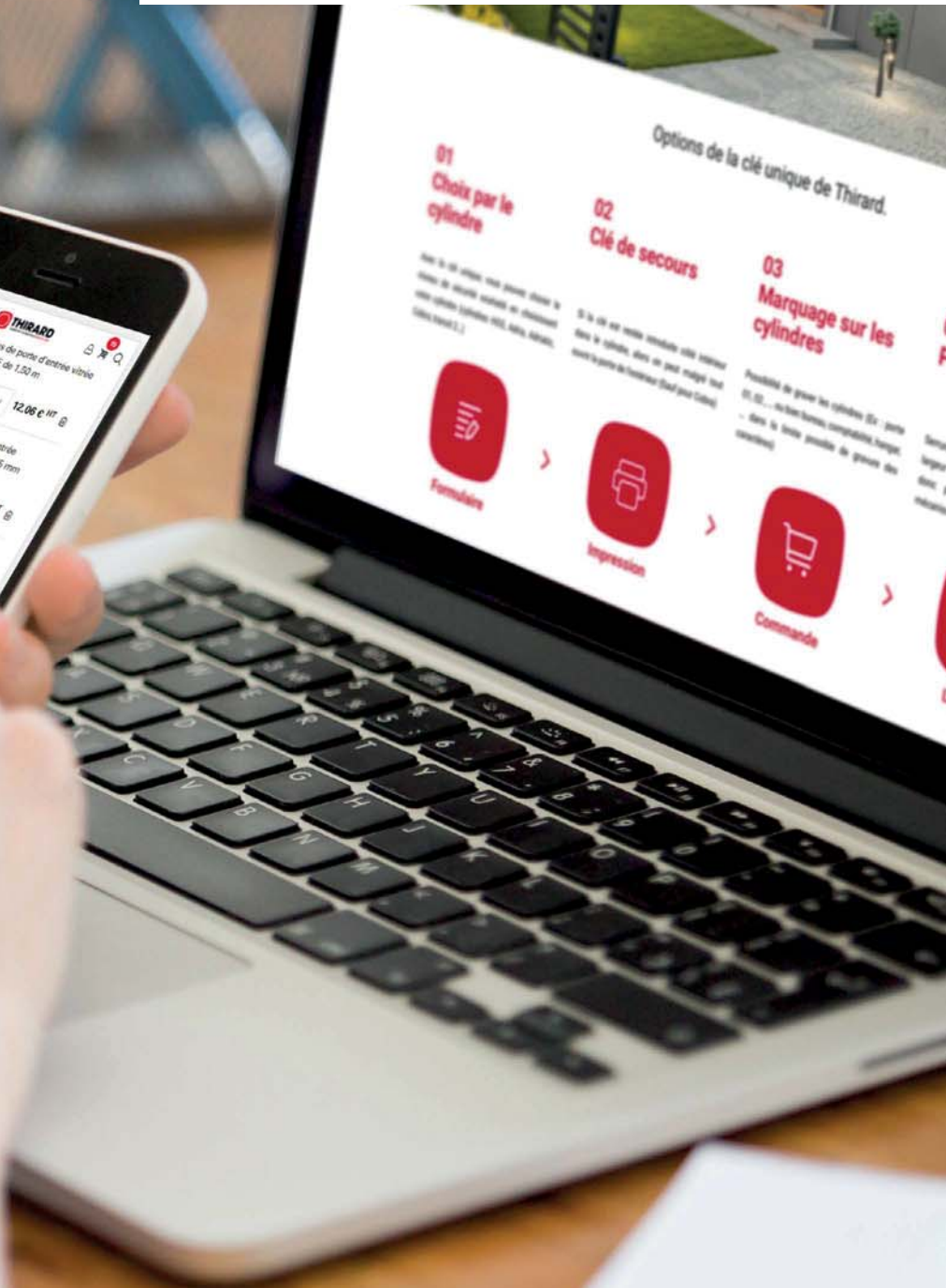

Véritable innovation, le service THIRARD OSSITO est une extension d'offre sur le web. Ce service permet d'avoir accès à l'ensemble du catalogue - soit + de 10 000 références - en complément des produits du magasin.

A real innovation, the THIRARD OSSITO service is an extension of the offer on the web. This service gives access to the entire catalogue over 10 000 references in addition to the products in the store.

Una verdadera innovación, el servicio THIRARD OSSITO es una extensión de la oferta en la web. Este servicio permite acceder a todo el catálogo, es decir, más de 10 000 referencias, además de los productos de la tienda. Además de la ampliación de la oferta,

Le service, véritable levier de développement !

En plus de l'extension d'offre, THIRARD OSSITO propose de nombreux services tels que :

- un module de commande rapide
- le suivi de commande
- un accès à l'ensemble des stocks disponibles
- la mensualisation des paiements
- la livraison sur site en 48h

THIRARD OSSITO est également un outil informatique puissant qui facilite la recherche des produits et propose des outils d'aide à la vente tels que des fiches produits complètes, des astuces de pose et des aides au choix.

In addition to the offer extension, THIRARD OSSITO offers many services as

- *A fast order module*
- *The order tracking*
- *An access to all available stocks*
- *Monthly payments*
- *The delivery on site in 48 hours*

THIRARD OSSITO is also powerful IT tool that facilitates product research and offers sales support tools such as complete products files, installation tips and selection aids.

THIRARD OSSITO ofrece numerosos servicios como

- Un módulo de pedido rápido
- Seguimiento de los pedidos
- Acceso a todos los productos disponibles
- Pagos mensuales
- Entrega in el sitio en 48 horas.

THIRARD OSSITO es también una potente herramienta informática que facilita la búsqueda de productos y ofrece herramientas de apoyo a la venta, como fichas completas de productos, consejos de instalación y ayudas a la selección.

THIRARD **-ossito**

WEB

La refonte du site Thirard - www.thirard.fr - est l'expression même des évolutions majeures de l'entreprise en matière de communication et de services. Cette nouvelle approche du web s'inscrit dans la politique générale de Thirard autour de l'expérience client.

L'évolution du site web Thirard se traduit par :

- La mise à disposition de la base de donnée produit complète (data) qui offre ainsi une **extension de l'offre sur les plateformes des distributeurs**
- L'accès aux informations techniques sur l'intégralité des références du catalogue, ainsi qu'à des documents téléchargeables
- La mise en ligne régulières de **tutoriels d'aide à la pose et de conseils techniques**
- L'accompagnement des professionnels par de la formation
- Le renouvellement régulier d'informations sur les **nouveautés produits**, les événements et l'actualité de l'entreprise
- L'orientation vers des points de vente physiques ou web lors d'une recherche, dans un objectif de transformation de la visite
- La mise en place d'un service de commande de clés en ligne.

L'activation de ces services ainsi que l'animation des réseaux sociaux confirme l'engagement de Thirard dans le digital afin de satisfaire les besoins d'information des clients.

The redesign of Thirard website - www.thirard.fr - is the very expression of major evolutions in the company in terms of communication and services. This new web approach fits in Thirard general policy around customer's experiences.

Thirard website evolution translate into :

- *The provision of complete product database, which thus provides an **extension of our offer in our distributor's platforms***
- *The access to technical information on the whole catalog references, as well as downloadable documents.*
- *The regular release of operating instruction **tutorials and technical advices***
- *Supporting professionals thanks to training*
- *The regular renewal of information on **new products, events, and company news***
- *The redirection towards a physical or web point of sales during the research, in order to transform the research into purchase*
- *Creation of an online key ordering service*

The activation of these services and the animation of social media confirm Thirard's commitment in the digital, in order to meet customer's needs in terms of information.

El rediseño de la web de Thirard (www.thirard.fr) es la expresión misma de las principales evoluciones de la compañía en términos de comunicación y servicios. Este nuevo enfoque de la web es parte de la política general de Thirard alrededor de nuestra experiencia del cliente.

L'expérience client, priorité stratégique

La evolución del sitio web de Thirard se refleja en:

- La disponibilidad de la base de datos completa del producto (data) que ofrece **una extensión de la oferta en las plataformas de los distribuidores**
- Acceso a información técnica en todas las referencias del catálogo, así como a documentos descargables
- Carga periódica de **tutoriales para asistencia de instalación** y asesoramiento técnico.
- Coaching de profesionales para la formación
- Renovación periódica de información sobre **nuevos productos**, eventos y noticias de la empresa
- Orientación hacia los puntos de venta físicos o web durante la búsqueda
- Creación de un servicio de pedido de llaves online.

La activación de estos servicios, así como la animación de las redes sociales, confirman el compromiso de Thirard en el mundo digital para satisfacer las necesidades de información de los clientes.

digital

THIRARD 1888

Rechercher un produit ou une référence... **Rechercher**

THIRARD-ossifo   CASA 100% LOGUE

Les Produits Services Astuces Brico Commande de clés A propos de Thirard

TOUT OUVRIR avec la même clé c'est possible

Découvrez la clé unique

En savoir + 

+ Nouveautés et innovations THIRARD
L'innovation pour priorité



+ Verrou universel ajustable



+ Gamme électronique Intelock



+ Serrure universelle

Depuis 100 ans nous équipons votre habitat,
pour votre **confort** et votre **sécurité**

Q Autour de la clé
Nos services pour améliorer votre quotidien.

Vos doubles de clés

Clé unique

Ogramme

💡 Les astuces THIRARD
Nos experts vous accompagnent.
Découvrez des conseils du quotidien adaptés aussi bien pour les professionnels que pour les particuliers !



Bien choisir sa serrure en applique



Quel cylindre est le plus adapté à ma porte ?



Comment choisir sa serrure à encastrer ?



Comment installer un ferme porte hydraulique ?











Comment changer le code d'un cadenas ?





Contrôle d'accès

Intellock Multi		32
Intellock Room		33
Intellock Gate		34
Intellock Box		34
Serrures Intellock		35
Plaques de propreté		36
Cylindre électronique		37
Poignée électronique		38
Poignée électronique à clavier		39
Poignée électronique compact		40



Description/Description/Descripción

Poignée électronique intelligente 6 en 1 RFID (MIFARE 13,56 Mhz)/BLUETOOTH en boîtier aluminium recouverte d'une coque en acier inoxydable 304 avec trou de cylindre entr'axe 85 mm. Convient pour porte en aluminium ou bois épaisseur de 35 à 65 mm. Poignéeversible carré de 8 mm. Six façons de déverrouiller : Bluetooth(APP TTLOCK), empreinte digitale (200 max.), carte mifare (200 max.), code PIN (150 max.), clé mécanique, gateway wifi G2 (option). Application: TTLOCK pour IOS / ANDROID et PC (WEB). Alimentation 4 Piles LR03 - AAA non fournis. Port d'alimentation de secours : USB.

RFID access control with opening by Mifare 13.56Mhz card, combination, Bluetooth smartphone, biometrics. Remote access management with TTLock application (iOS and Android). Powered by 4 AAA batteries. 10,000 cycles (open/close) autonomy. Low-voltage warning beeper, emergency power supply via USB port.

Control de acceso RFID con apertura por tarjeta Mifare

13,56Mhz, combinación, smartphone Bluetooth, biometría. Gestión del acceso remoto con la aplicación TTLock (iOS y Android). Funciona con 4 pilas AAA. 10.000 ciclos (apertura/cierre). Alarma sonora de bajo voltaje, alimentación de emergencia a través del puerto USB.

Finition/Finish/Acabado

Argent, doré

Silver, gold

Plata, dorado

Versión/Option/Versión

Poignée électronique avec ouverture par carte. Poignée électronique avec ouverture par carte, combinaison, application, empreinte digitale et clé.

Electronic handle with card opening. Electronic handle with opening by card, combination, application, fingerprint and key.

Manilla electrónica con apertura de tarjeta. Manilla electrónica con apertura por tarjeta, combinación, aplicación, biometria y llave.

Designation	Boite	Colis.	Prix	Sachet	Colis.	Prix	Brochable					Colis.	Prix
							France	Euro 1	Euro 2	Euro 3	Euro 4		
POIGNÉE «MULTI» EA85mm finition argent	00078923	1	-	-	-	-	-	-	-	-	-	-	-
POIGNÉE «MULTI» EA70mm finition dorée	00078911	1	-	-	-	-	-	-	-	-	-	-	-
POIGNÉE «MULTI» EA72mm finition dorée	00078912	1	-	-	-	-	-	-	-	-	-	-	-
POIGNÉE «MULTI» EA85mm finition dorée	00078913	1	-	-	-	-	-	-	-	-	-	-	-
POIGNÉE «MULTI» EA70mm finition argent	00078921	1	-	-	-	-	-	-	-	-	-	-	-
POIGNÉE «MULTI» EA72mm finition argent	00078922	1	-	-	-	-	-	-	-	-	-	-	-
PASSERELLE Wifi / Bluetooth	00078934	1	-	-	-	-	-	-	-	-	-	-	-
TAG avec anneau brisé	00078936	1	-	-	-	-	-	-	-	-	-	-	-



GARANTIE

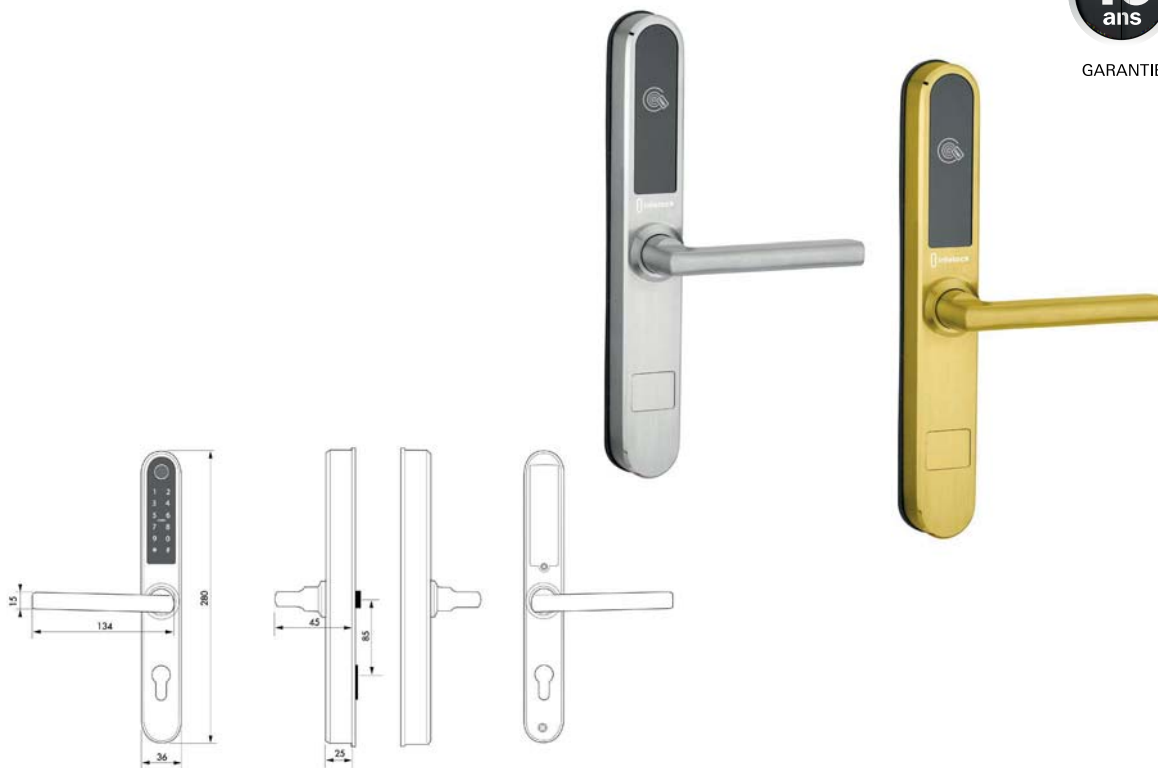

Description/Description/Descripción

Poignée électronique RFID (MIFARE 13,56 Mhz) pour gamme hôtel en boîtier aluminium recouverte d'une coque en acier inoxydable 304. Convient pour porte en aluminium ou bois épaisseur de 30 à 80 mm. Poignée réversible carré de 8 mm. Deux façons de déverrouiller : carte mifare, clé mécanique. Application : eLock (PC). Alimentation 4 Piles LR03 - AAA non fournis
Electronic RFID (MIFARE 13,56 Mhz) handle for hotel range in aluminium case covered with a 304 stainless steel shell. Suitable for aluminium or wooden doors from 30 to 80 mm thick. Reversible 8 mm square handle. Two ways of unlocking: mifare card, mechanical key. Application : eLock (PC). Power supply 4 LR03 - AAA batteries not included

Asa electrónica RFID (MIFARE 13,56 Mhz) para la gama de hoteles en caja de aluminio cubierta con una carcasa de acero inoxidable 304. Adecuado para puertas de aluminio o madera de 30 a 80 mm de grosor. Mango cuadrado reversible de 8 mm. Dos formas de desbloqueo: tarjeta mifare, llave mecánica. Aplicación : eLock (PC). Alimentación 4 pilas LR03 - AAA no incluidas

Finition/Finish/Acabado

Argent, doré
 Silver, gold
 Plata, dorado

Version/Option/Versión

Droite et Gauche
 Right and Left
 Derecha e izquierda

Designation	Boîte	Colis.	Prix	Sachet	Colis.	Prix	Brochable					Colis.	Prix
							France	Euro 1	Euro 2	Euro 3	Euro 4		
POIGNÉE «ROOM» finition dorée	00078910	1	-	-	-	-	-	-	-	-	-	-	-
POIGNÉE «ROOM» finition argent	00078920	1	-	-	-	-	-	-	-	-	-	-	-
PROGRAMMATEUR	00078930	1	-	-	-	-	-	-	-	-	-	-	-
ECONOMISEUR d'énergie	00078931	1	-	-	-	-	-	-	-	-	-	-	-
COLLECTEUR de données	00078932	1	-	-	-	-	-	-	-	-	-	-	-
CARTE gamme «ROOM»	00078935	1	-	-	-	-	-	-	-	-	-	-	-

⚠ Non stocké/Non-stored/Producto no estocado - 📍 Sur stock Europe Zone 1 et Zone 2, nous consulter pour délai d'approvisionnement - 📦 Epuisement/Stock depletion/Agotamiento del stock

Contrôle d'accès / Intellock Gate

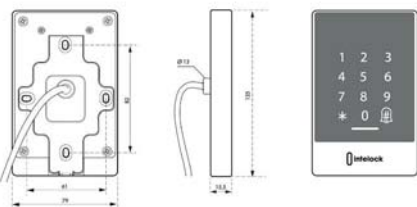

Description/Description/Descripción

Lecteur mural IP66 RFID (MIFARE 13,56 Mhz)/ BLUETOOTH et code avec cadre en aluminium / panneau en verre trempé. Quatre façons de déverrouiller : Bluetooth (APP TTLOCK), carte mifare(20000 max.), code PIN (illimité), gateway wifi G2 (option). Application TTLOCK : IOS / ANDROID / PC (WEB). Commande ventouse/Serrure electromécanique/Sonnerie de porte. Alimentation : 12 V 3A (pas fournis).
IP66 RFID (MIFARE 13,56 Mhz)/BLUETOOTH and code wall reader with aluminium frame / tempered glass panel. Four ways to unlock: Bluetooth (TTLOCK APP), MIFARE card (20000 max.), PIN code (unlimited), G2 wifi gateway (optional). TTLOCK application: IOS / ANDROID / PC (WEB). Suction cup control / Electromechanical lock / Door bell. Power supply: 12 V 3A (not supplied).

Lector mural RFID (MIFARE 13,56 Mhz)/ BLUETOOTH y de código IP66 con marco de aluminio / panel de vidrio templado. Cuatro formas de desbloqueo: Bluetooth (TTLOCK APP), tarjeta MIFARE (20000 máx.), código PIN (ilimitado), pasarela wifi G2 (opcional). Aplicación TTLOCK: IOS / ANDROID / PC (WEB). Mando de ventosa / Cerradura electromecánica / Timbre de puerta. Alimentación: 12 V 3A (no suministrada).



GARANTIE

Designation	Boite	Colis.	Prix	Sachet	Colis.	Prix	Brochable					Colis.	Prix
							France	Euro 1	Euro 2	Euro 3	Euro 4		
CONTROLEUR D'ACCÈS à clavier	00078933	1	-	-	-	-	-	-	-	-	-	-	-

Contrôle d'accès / Intellock Box



Description/Description/Descripción

Serrure à casier électronique RFID (MIFARE 13,56 Mhz)/BLUETOOTH. Quatre façons de déverrouiller : Bluetooth(APP TTLOCK), carte mifare, code PIN, gateway wifi G2 (option). Application: TTLOCK pour IOS / ANDROID et PC (WEB). Alimentation 4 Piles LR03 - AA non fournis. Port d'alimentation de secours : USB
Electronic locker RFID (MIFARE 13,56 Mhz)/ BLUETOOTH. Four ways of unlocking: Bluetooth(APP TTLOCK), mifare card, PIN code, wifi gateway G2 (optional). Application: TTLOCK for IOS / ANDROID and PC (WEB). Power supply 4 LR03 - AA batteries not supplied. Backup power port: USB

Taquilla electrónica RFID (MIFARE 13,56 Mhz)/ BLUETOOTH. Cuatro formas de desbloqueo: Bluetooth (APP TTLOCK), tarjeta mifare, código PIN, wifi gateway G2 (opcional). Aplicación: TTLOCK para IOS / ANDROID y PC (WEB). Alimentación 4 pilas LR03 - AA no suministradas. Puerto de alimentación de reserva: USB

Finition/Finish/Acabado

Noir
 Black
 Negro



GARANTIE

Designation	Boite	Colis.	Prix	Sachet	Colis.	Prix	Brochable					Colis.	Prix
							France	Euro 1	Euro 2	Euro 3	Euro 4		
SERRURE ÉLECTRONIQUE de casier	00078948	1	-	-	-	-	-	-	-	-	-	-	-



Description/Description/Descripción

Serrure à encastrer à éjection du pêne avec fonction urgence. Carré: 8 mm. Demi-tour réversible sans démontage du coffre. Tête inox. Pêne acier inoxydable SUS304. Compatible avec S31B-C70.

Mortise lock with bolt ejection and emergency function. Square: 8 mm. Reversible latch without disassembling the box. Stainless steel bolt SUS304. Compatible with S31B-C70.

Cerradura de embutir con expulsión del cerrojo y función de emergencia. Cuadrado: 8 mm. Pestillo reversible sin necesidad de desmontar la caja. Perno de acero inoxidable SUS304. Compatible con el S31B-C70.

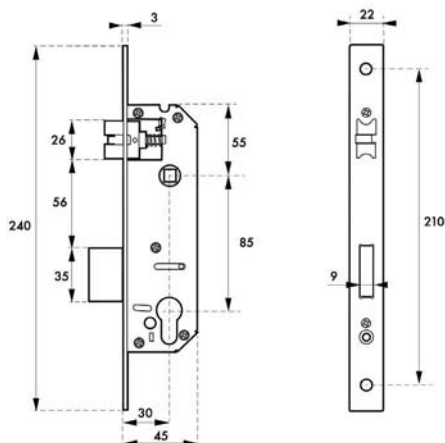

Designation	Boîte	Colis.	Prix	Sachet	Colis.	Prix	Brochable					Colis.	Prix
							France	Euro 1	Euro 2	Euro 3	Euro 4		
SERRURE à encastrer Axe 30mm EA 85mm bouts carrés	00078970	1	-	-	-	-	-	-	-	-	-	-	-
SERRURE à encastrer Axe 35mm EA 85mm bouts carrés	00078980	1	-	-	-	-	-	-	-	-	-	-	-
SERRURE à encastrer Axe 50mm EA 70mm bouts carrés	00078940	1	-	-	-	-	-	-	-	-	-	-	-
SERRURE à encastrer Axe 50mm EA 85mm bouts carrés	00078942	1	-	-	-	-	-	-	-	-	-	-	-
SERRURE à encastrer Axe 45mm EA 85mm bouts carrés	00078944	1	-	-	-	-	-	-	-	-	-	-	-
SERRURE à encastrer Axe 60mm EA 85mm bouts carrés	00078990	1	-	-	-	-	-	-	-	-	-	-	-
SERRURE à encastrer Axe 50mm EA 70mm bouts ronds	00078960	1	-	-	-	-	-	-	-	-	-	-	-
SERRURE à encastrer Axe 50mm EA 85mm bouts ronds	00078962	1	-	-	-	-	-	-	-	-	-	-	-
SERRURE à encastrer Axe 45mm EA 85mm bouts ronds	00078964	1	-	-	-	-	-	-	-	-	-	-	-

☒ Non stocké/Non-stored/Producto no estocado - ☑ Sur stock Europe Zone 1 et Zone 2, nous consulter pour délai d'approvisionnement - ☒ Epuisement/Stock depletion/Agotamiento del stock



GARANTIE



Description/Description/Descripción

Plaque de propreté epaisseur 1,5 mm en inox brossé adaptable pour P33 et S31-C.

1.5 mm thick brushed stainless steel backplate suitable for P33 and S31-C.

Placa trasera de acero inoxidable cepillado de 1,5 mm de grosor adecuada para P33 y S31-C.

Finition/Finish/Acabado

Emerisée grain 220 + Film

Emerised 220 grain + Film

Surgido grano 220 + Película

Designation	Boite	Colis.	Prix	Sachet	Colis.	Prix	Brochable					Colis.	Prix
							France	Euro 1	Euro 2	Euro 3	Euro 4		
PLAQUE DE PROPRETE 60X302 MM RECTANGULAIRE INOX BROSSE	00078950	1	-	-	-	-	-	-	-	-	-	-	-
PLAQUE DE PROPRETE 60X302 MM ARRONDIE INOX BROSSE	00078951	1	-	-	-	-	-	-	-	-	-	-	-
PLAQUE DE PROPRETE 70X312 MM RECTANGULAIRE INOX BROSSE	00078952	1	-	-	-	-	-	-	-	-	-	-	-
PLAQUE DE PROPRETE 70X312 MM ARRONDIE INOX BROSSE	00078953	1	-	-	-	-	-	-	-	-	-	-	-

⚠ Non stocké/Non-stored/Producto no estocado - 📦 Sur stock Europe Zone 1 et Zone 2, nous consulter pour délai d'approvisionnement - ⚠ Epuisement/Stock depletion/Agotamiento del stock



GARANTIE

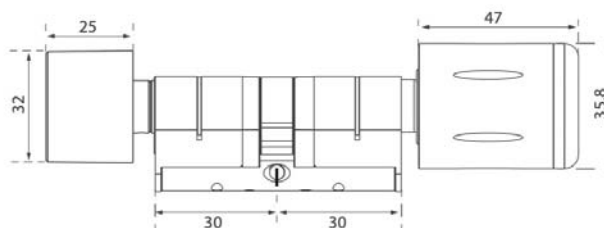

Description/Description/Descripción

Cylindre électronique modulaire RFID (Mifare 13,56 Mhz) avec fonction BLUETOOTH. Dimensions disponibles : de 30/30 à 90/90 mm. Protection anti-perçage. Deux façons de déverrouiller : carte mifare classic/desfire (distance de lecture : Jusqu'à 25 mm), Bluetooth(eKey). Application : WAFFERLOCK eKey iOS / Android. Batterie 1 Piles CR2 fournis, autonomie de 60000 opérations ou 5 ans. Avertissement sonore si batterie faible. Indice de protection IP67.

Modular electronic RFID cylinder (Mifare 13,56 Mhz) with BLUETOOTH function. Available sizes: from 30/30 to 90/90 mm. Anti-drilling protection. Two ways of unlocking : mifare classic/desfire card (reading distance : up to 25 mm), Bluetooth(eKey). Application: WAFFERLOCK eKey iOS / Android. Battery 1 CR2 batteries provided, autonomy of 60000 operations or 5 years. Low battery warning. IP67 protection rating.

Cilindro electrónico modular RFID (Mifare 13,56 Mhz) con función BLUETOOTH. Tamaños disponibles: de 30/30 a 90/90 mm. Protección antiperforación. Dos formas de desbloqueo: tarjeta mifare classic/desfire (distancia de lectura: hasta 25 mm), Bluetooth(eKey). Aplicación: WAFFERLOCK eKey iOS / Android. Batería 1 pilas CR2 suministradas, autonomía de 60000 operaciones o 5 años. Aviso de batería baja. Grado de protección IP67.

Finition/Finish/Acabado

Nickel satin

Satin nickel

Níquel satinado

Versión/Option/Versión

Cylindre Modulable - Contrôle d'accès extérieur / Bouton intérieur

Modular Cylinder - External access control / Internal knob

Cilindro modular - Control de acceso externo / Pomo

interno

Designation	Boite	Colis.	Prix	Sachet	Colis.	Prix	Brochable					Colis.	Prix
							France	Euro 1	Euro 2	Euro 3	Euro 4		
CYLINDRE BOUTON ELECTRONIQUEBLUETOOTH 60MM (30/30) - MOD	C7023030B00	1	-	-	-	-	-	-	-	-	-	-	-
1/2 CYLINDRE ELECTRONIQUE^A BLUETOOTH 40MM (30/10) - MOD	C702M3010B00 ^{NS}	1	-	-	-	-	-	-	-	-	-	-	-
DOUBLE CYLINDRE ELECTRONIQUE^A BLUETOOTH 60MM (30/30) - MOD	C702N3030B00 ^{NS}	1	-	-	-	-	-	-	-	-	-	-	-
CYLINDRE ELECTRONIQUE A COMBINAISON BLUETOOTH 70MM (35/35) - MONO	C7503535B00	1	-	-	-	-	-	-	-	-	-	-	-

^{NS} Non stocké/Non-stored/Producto no estocado - [□] Sur stock Europe Zone 1 et Zone 2, nous consulter pour délai d'approvisionnement - ^E Epuïsement/Stock depletion/Agotamiento del stock



Description/Description/Descripción

Poignée électronique RFID (Mifare 13,56 Mhz) avec fonction BLUETOOTH. Convient pour porte épaisseur de 40 à 120 mm. Carré de 8 mm. Trou de cylindre entr'axe de 70 (Option: 72/85/92 mm). Deux façons de déverrouiller: carte Mifare classic/Desfire (distance de lecture : Jusqu'à 30 mm), Bluetooth(eKey). Application : WAFERLOCK eKey iOS / Android. Batterie 1 Piles CR2 fournis, avertissement si batterie faible, autonomie de 60000 opérations ou 5 ans. Indice de Protection IP67.

Electronic RFID handle (Mifare 13,56 Mhz) with BLUETOOTH function. Suitable for door thicknesses from 40 to 120 mm. 8 mm square. Cylinder hole of 70 mm (Option: 72/85/92 mm). Two ways of unlocking: Mifare classic/Desfire card (reading distance: up to 30 mm), Bluetooth(eKey). Application: WAFERLOCK eKey iOS / Android. Battery 1 CR2 battery supplied, low battery warning, 60000 operations or 5 years autonomy. IP67 protection rating.

Asa electrónica RFID (Mifare 13,56 Mhz) con función BLUETOOTH. Adecuado para espesores de puerta de 40 a 120 mm. Cuadrado de 8 mm. Orificio del cilindro de 70 mm (opción: 72/85/92 mm). Dos formas de desbloqueo: tarjeta Mifare classic/Desfire (distancia de lectura: hasta 30 mm), Bluetooth(eKey). Aplicación: WAFERLOCK eKey iOS / Android. Batería 1 batería CR2 suministrada, aviso de batería baja, 60000 operaciones o 5 años de autonomía. Grado de protección IP67.

Finition/Finish/Acabado

Inox Brossé
Brushed stainless steel
Acero inoxidable cepillado

Version/Option/Versión

Gauche. Avec trou de cylindre
Left hand side. With cylinder hole
A la izquierda. Con orificio para el cilindro

Designation	Boite	Colis.	Prix	Sachet	Colis.	Prix						Colis.	Prix
							France	Euro 1	Euro 2	Euro 3	Euro 4		
POIGNEE ELECTRONIQUE BLUETOOTH -70 GAUCHE	WEL700B0070L 	1	-	-	-	-	-	-	-	-	-	-	-
POIGNEE ELECTRONIQUE BLUETOOTH -70 DROITE	WEL700B0070R 	1	-	-	-	-	-	-	-	-	-	-	-



Description/Description/Descripción

Poignée électronique à code RFID (Mifare 13,56 Mhz) avec fonction BLUETOOTH. Convient pour porte épaisseur de 40 à 120 mm. Carré de 8 mm. Trou de cylindre entr'axe de 70 (Option: 72/85/92 mm). Trois façons de déverrouiller: Code PIN, carte Mifare classic/Desfire, Bluetooth(eKey). Application : WAFERLOCK eKey iOS / Android. Batterie 1 Piles CR2 fournis, avertissement si batterie faible, autonomie de 60000 opérations ou 5 ans. Indice de Protection IP67.

Electronic handle with RFID code (Mifare 13,56 Mhz) with BLUETOOTH function. Suitable for door thicknesses from 40 to 120 mm. 8 mm square. Cylinder hole of 70 mm (Option: 72/85/92 mm). Three ways to unlock: PIN code, Mifare classic/Desfire card, Bluetooth(eKey). Application: WAFERLOCK eKey iOS / Android. Battery 1 CR2 battery supplied, low battery warning, 60000 operations or 5 years autonomy. IP67 protection rating.

Asa electrónica con código RFID (Mifare 13,56 Mhz) con función BLUETOOTH. Adecuado para espesores de puerta de 40 a 120 mm. Cuadrado de 8 mm. Orificio del cilindro de 70 mm (opción: 72/85/92 mm). Tres formas de desbloqueo: código PIN, tarjeta Mifare classic/Desfire, Bluetooth(eKey). Aplicación: WAFERLOCK eKey iOS / Android. Batería 1 batería CR2 suministrada, aviso de batería baja, 60.000 operaciones o 5 años. Grado de protección IP67.

Finition/Finish/Acabado

Inox Brossé
Brushed stainless steel
Acero inoxidable cepillado

Version/Option/Versión

Gauche. Avec trou de cylindre
Left hand side. With cylinder hole
A la izquierda. Con orificio para el cilindro

Designation	Boite	Colis.	Prix	Sachet	Colis.	Prix	Brochable					Colis.	Prix
							France	Euro 1	Euro 2	Euro 3	Euro 4		
POIGNEE ELECTRONIQUE BLUETOOTH - CLAVIER -70 GAUCHE	WEL701B0070L	1	-	-	-	-	-	-	-	-	-	-	-
POIGNEE ELECTRONIQUE BLUETOOTH - CLAVIER -70 DROITE	WEL701B0070R	1	-	-	-	-	-	-	-	-	-	-	-

Non stocké/Non-stored/Producto no estocado - Sur stock Europe Zone 1 et Zone 2, nous consulter pour délai d'approvisionnement - Epuïsement/Stock depletion/Agotamiento del stock

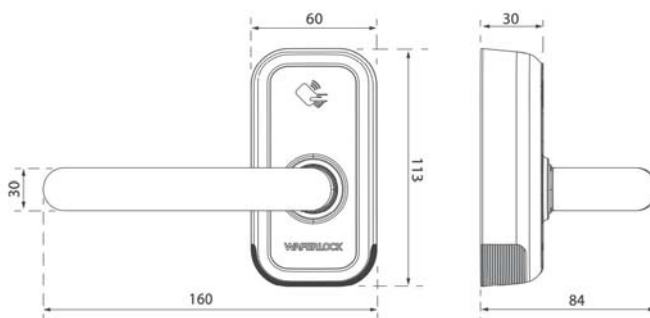

Description/Description/Descripción

Poignée électronique compact RFID (Mifare 13,56 Mhz) avec fonction BLUETOOTH. Convient pour porte épaisseur de 40 à 100 mm. Deux façons de déverrouiller: carte Mifare classic/Desfire (distance de lecture : Jusqu'à 30 mm), Bluetooth(eKey). Application : WAFERLOCK eKey iOS / Android. Batterie 1 Piles CR2 fournis, avertissement si batterie faible, autonomie de 10000 opérations.
 Compact electronic RFID handle (Mifare 13,56 Mhz) with BLUETOOTH function. Suitable for door thickness from 40 to 100 mm. Two ways of unlocking: Mifare classic/Desfire card (reading distance: up to 30 mm), Bluetooth(eKey). Application: WAFERLOCK eKey iOS / Android. Battery

1 CR2 batteries provided, low battery warning, 10,000 operation time.

Manilla electrónica RFID compacta (Mifare 13,56 Mhz) con función BLUETOOTH. Adecuado para puertas de 40 a 100 mm de grosor. Dos formas de desbloqueo: tarjeta Mifare classic/Desfire (distancia de lectura: hasta 30 mm), Bluetooth(eKey). Aplicación: WAFERLOCK eKey iOS / Android. Batería 1 pilas CR2 suministradas, aviso de batería baja, 10.000 horas de funcionamiento.

Version/Option/Versión

Gauche
 Left
 Izquierda

Designation	Boite	Colis.	Prix	Sachet	Colis.	Prix	Brochable					Colis.	Prix
							France	Euro 1	Euro 2	Euro 3	Euro 4		
POIGNEE ELECTRONIQUE COMPACT BLUETOOTH -70 GAUCHE	WEL730B0070L <small>NS</small>	1	-	-	-	-	-	-	-	-	-	-	-
POIGNEE ELECTRONIQUE COMPACT BLUETOOTH -70 DROITE	WEL730B0070R <small>NS</small>	1	-	-	-	-	-	-	-	-	-	-	-

NS Non stocké/Non-stored/Producto no estocado - Sur stock Europe Zone 1 et Zone 2, nous consulter pour délai d'approvisionnement - Epuisement/Stock depletion/Agotamiento del stock

Notes





Cadenas



CADENAS	46
ANTIVOL	145
PORTE-CADENAS	162
BOÎTE À CLÉS	167
SUPPLÉMENTS POUR CADENAS	173

*Sommaire détaillé par produit
page suivante*



*Chapitre CONSIGNATION
page 174*



Cadenas

CADENAS

Type 1 alu		46
Type 1 anse acier		47
Type 1 anse laiton		48
Country		49
Love		50
Happy Lock		51
Ch'tiote Meuh		51
Line Sport		52
Astrolock		53
Green Idea		54
Extra Lock		54
Better World		55
Fashion Leather		55
Graffiti		56
Swish		56
Bora Bora		57
Papeete		57
Compact		58
Moorea		59
Extenso		59
Fantasy		60
Nomad		61
Funny		62
Mousqueton		63
Ruck		64
Mach 2 anse acier		64
Mach 2 anse laiton		65
TSA anse acier		65
158 - 208		66
Venus		66
Club 2		67

Street		67
Luxe		68
RB		69
TSA à combinaison		70
Type 1 Alu		71
Type 1 anse acier		73
Type 1 anse laiton		75
Anse réglable		76
Thirard Color anse acier		77
Thirard Color anse laiton		78
Ruby		79
Ruby color		80
Colorful		81
Astra anse acier		82
2493		82
Type 1 Code		83
Compact 04		84
College		84
Tanker		85
Zipper		85
Roller		86
Multicable		86
Shoulder		87
Cobble		88
Land		89
Disk		90
258		90
Venus		91
Club 2		91
Baggy		92
M54		92
Saturn		93

Thor		93
Code-x		94
Digital		94
Digital Color		95
Type 1 anse inox		96
Slice		98
Upper		98
Slice gainé		99
Astra +		100
Tank		100
Ruck		101
Type 1 +		103
Mach 2 anse acier		104
Mach 2 anse laiton		105
Sea Line		106
Bumper		107
Astra		108
Cinox		109
Rinox		110
Octo		111
Octo-P		112
Reverso		113
Quadra		114
Mach 3 anse inox		115
Mach 3 Bumper		117
Mach 3 AP		118
Adriatic		119
Nautic anse acier		120
Nautic anse laiton		121
Nautic anse acier gainé		122
510 - 520 - 530		123
510P - 520P - 530P		126



Trek		127
Amazone		128
Mach 3 anse inox		129
Skipper		130
Marinox		131
Protector		132
710 - 720 - 720P - S900R		133
Docker		136
Land Blindé		137
Land Blindé CP		138
Cargo		139
Transit 2 clé réversibles		140
Inox		141
RB combinaison modifiable		142
Tanker 2		143
SR - SRH - SRP		144

ANTIVOL

Twisty		145
Twisty combinaison fixe		145
Twisty 1,5m		146
Twisty à câble		146
Up		147
Loops		147
Twisty		148
Softy		148
Softy combinaison modifiable		149
Twisty		149
Twisty		150
Scorp		150
Twisty		151
Twisty combinaison modifiable		151
Twisty cable		152
Up		152
Twisty combinaison modifiable		153
Scorp		153
Loops		154
Up		154
Block		155
Block		155
Twisty		156
Stunt		156
Scorp		157
Up		157
Zebra		158
Zebra à combinaison modifiable		158
Biker		159
Scorp		159
Loops		160
Loops		160
Loops		161
Tête d'attelage		161

PORTE-CADENAS

Œillet		162
A pattes		162
A recouvrement		163
A recouvrement		163
A recouvrement		164
Renforcé		164
A recouvrement		165
A recouvrement		165
Pour grille		165
A recouvrement		166
Renforcé à recouvrement		166
Renforcé		167

BOÎTE À CLÉS

Boîte à clé combinaison modifiable		167
Boîte à clé combinaison modifiable		168
Boîte à clé combinaison modifiable		168
Boîte à clé combinaison modifiable		169
Boîte à clé combinaison modifiable		169
Coffret de sécurité		170
Boîte à clé avec anse		170
Boîte à clé à cylindre		171
Boîte à clé pour cylindre profilé		171
Cadenas à câble ordi		172
Suppléments pour cadenas		173

Cadenas de sûreté / TYPE 1 ALU VOYAGE



NIVEAU DE SÉCURITÉ



GARANTIE



Acier nickelé

Aluminium



Description/Description/Descripción

Corps aluminium. Anse acier nickelé
Mécanisme à goupilles. Simple ancrage.
2 clés laiton nickelé
*Aluminium body. Nickel plated steel shackle.
Pin mechanism. Simple locking. 2 nickel
plated brass keys.*
Cuerpo de aluminio. Arco de acero
niquelado. Mecanismo de pasadores.
Simple anclaje. 2 llaves de latón niquelado.

Finition/Finish/Acabado

Aluminium
Aluminium
Aluminio

Version/Option/Versión

Avec coque PVC.
With PVC shell.
Revestimiento de PVC.

Utilisation/Use/Utilización

Bagage
Luggage
Equipaje



X 2

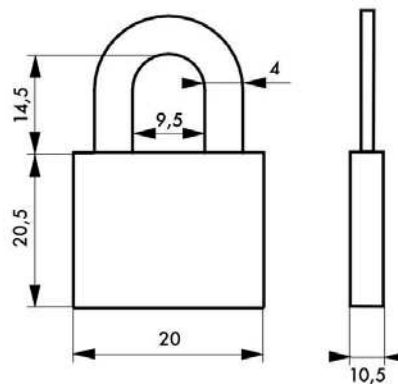

Designation	Boite	Colis.	Prix	Sachet	Colis.	Prix	Brochable					Colis.	Prix
							France	Euro 1	Euro 2	Euro 3	Euro 4		
Cadenas TYPE 1 ALU 20 mm	00024120	10	-	-	-	-	00124120	00193300 NS	00192300 NS	00194300	-	10	-
Cadenas TYPE 1 ALU COLOR 20 mm couleurs assorties	-	-	-	00924220	20	-	00124220	00193303 NS	00192303 NS	00194303	-	10	-
Cadenas TYPE 1 ALU COLOR 20 mm rouge	00024221	10	-	-	-	-	-	-	-	-	-	-	-
Cadenas TYPE 1 ALU COLOR 20 mm bleu	00024222	10	-	-	-	-	-	-	-	-	-	-	-
Cadenas TYPE 1 ALU COLOR 20 mm orange	00024223	10	-	-	-	-	-	-	-	-	-	-	-
Cadenas TYPE 1 ALU COLOR 20 mm vert	00024224	10	-	-	-	-	-	-	-	-	-	-	-
Cadenas TYPE 1 ALU COLOR 20 mm noir	00024225	10	-	-	-	-	-	-	-	-	-	-	-
Jeu de 4 Cadenas TYPE 1 ALU COLOR 20 mm s'ouvrant 8 clés	-	-	-	-	-	-	00124226	00193063	0019063	00194063	-	10	-

NS Non stocké/Non-stored/Producto no estocado - ☐ Sur stock Europe Zone 1 et Zone 2, nous consulter pour délai d'approvisionnement - ☒ Epuisement/Stock depletion/Agotamiento del stock

Cadenas de sûreté / TYPE 1

VOYAGE



NIVEAU DE SÉCURITÉ



GARANTIE

10 ans



X 2



Acier nickelé

Alliage



Description/Description/Descripción

Corps alliage monobloc. Anse acier nickelé. Mécanisme à goupilles. Simple ancrage. 2 clés acier nickelé.

Compact alloy body. Nickel plated steel shackle. Pin mechanism. Simple locking. 2 nickel plated steel keys.

Cuerpo de aleación monobloque. Arco de acero niquelado. Mecanismo de pasadores. Simple anclaje. 2 llaves de acero niquelado

Finition/Finish/Acabado

Bronze

Bronze

Bronze

Versión/Option/Versión

15 mm - Corps laiton

20 mm / 25 mm conditionnement boîte - Corps laiton 15 mm - Brass body

15 mm - Brass body

20 / 25 mm packaging box - Brass body

15 mm - Cuerpo de latón

20 / 25 mm caja de embalaje - Cuerpo de latón

Utilisation/Use/Utilización

Bagage

Luggage

Equipaje



Goup.

	15mm	20mm	25mm
	17	19	24
	9	11	12
	12	12	8,5
	8	11	13
	3	3	4
Goup.	3	3	3

Designation	Boite	Colis.	Prix	Sachet	Colis.	Prix	Brochable					Colis.	Prix
							France	Euro 1	Euro 2	Euro 3	Euro 4		
TYPE 1 • 15 mm	00061015	10	-	00961015	20	-	00161015	00193018	-	00194018	-	10	-
TYPE 1 • 20 mm	00061020	10	-	00961020	20	-	00161020	00193001 NS	00192001 NS	00194001	00195001 NS	10	-
TYPE 1 • 25 mm	00061025	10	-	00961025	20	-	00161025	00193002 NS	00192002 NS	00194002	00195002 NS	10	-
Jeu de 3 cadenas TYPE 1 • 15 mm s'ouvrant 6 clés	-	-	-	-	-	-	-	-	-	00194024	-	10	-
Jeu de 2 cadenas TYPE 1 • 20 mm s'ouvrant 4 clés	-	-	-	00961024	10	-	00161024	00193005 NS	00192005 NS	00194005	-	10	-

NS Non stocké/Non-stored/Producto no estocado - Sur stock Europe Zone 1 et Zone 2, nous consulter pour délai d'approvisionnement - E Epuisement/Stock depletion/Agotamiento del stock

Cadenas de sûreté / TYPE 1 VOYAGE



NIVEAU DE SÉCURITÉ



GARANTIE



Laiton

Laiton



X 2



Description/Descripción

Corps laiton monobloc. Anse laiton. Mécanisme à goupilles. Simple ancrage. 2 clés acier nickelé *Compact brass body. Brass shackle. Pin mechanism. Simple locking. 2 nickel plated steel keys.*

Cuerpo de latón monobloque. Arco de latón. Mecanismo de pasadores. Simple anclaje. 2 llaves de acero niquelado.

Finish/Acabado

Laiton poli.
Polished brass.
Latón pulido.

Use/Utilización

Bagage
Luggage
Equipaje

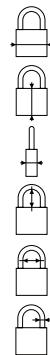

Goup.

	15mm	20mm	25mm
	15mm	20mm	25mm
	17	20	22
	9	10	11
	12	12	13
	8	10	13
	3	3,5	4
Goup.	3	3	4

Designation	Boite	Colis.	Prix	Sachet	Colis.	Prix	Brochable					Colis.	Prix
							France	Euro 1	Euro 2	Euro 3	Euro 4		
TYPE 1 • 15 mm	-	-	-	-	-	-	-	-	-	00194016	-	10	-
TYPE 1 • 20 mm	-	-	-	-	-	-	00161021	00193019 NS	00192019 NS	00194019	-	10	-
TYPE 1 • 25 mm	-	-	-	-	-	-	00161026	00193020 NS	00192020 NS	00194020	-	10	-

NS Non stocké/Non-stored/Producto no estocado - ☑ Sur stock Europe Zone 1 et Zone 2, nous consulter pour délai d'approvisionnement - ☒ Epuisement/Stock depletion/Agotamiento del stock

Cadenas de sûreté / COUNTRY VOYAGE



NIVEAU DE SÉCURITÉ



GARANTIE

Description/Description/Descripción
Corps acier embouti. Anse acier zingué.
2 clés acier nickelé.

Pressed steel case. Zinc plated steel shackle. 2 nickel plated steel keys.
Cuerpo de acero embutido. Arco de acero cincado. 2 llaves de acero niquelado.

Finition/Finish/Acabado

Couleurs assorties

Assorted colors

Colores surtidos

Utilisation/Use/Utilización

Fashion et fantaisie

Fashion and fancy

Moda y fantasía



X 2



	15 mm	25 mm	35 mm	45 mm
	15	25	35	45
	18	23	30	34
	10	10	13	16
	9	14	19	26
	7	12	18	25
	3	3,5	4,5	5,5
Goup.	6	6	6	6

Designation	Boite	Colis.	Prix	Sachet	Colis.	Prix	Brochable					Colis.	Prix
							France	Euro 1	Euro 2	Euro 3	Euro 4		
Cadenas COUNTRY 15 mm verni	-	-	-	-	-	-	00122015	00193989 NS	00192989 NS	00194989	-	10	-
Cadenas COUNTRY 25 mm verni	-	-	-	-	-	-	00122025	00193990 NS	00192990 NS	00194990	-	10	-
Cadenas COUNTRY 35 mm verni	-	-	-	00922035	20	-	00122035	00193991 NS	00192991 NS	00194991	-	10	-
Cadenas COUNTRY 45 mm verni	-	-	-	-	-	-	00122045	00193992 NS	00192992 NS	00194992	-	10	-

NS Non stocké/Non-stored/Producto no estocado - Sur stock Europe Zone 1 et Zone 2, nous consulter pour délai d'approvisionnement - E Epuisement/Stock depletion/Agotamiento del stock

Cadenas de sûreté / LOVE

VOYAGE



NIVEAU DE SÉCURITÉ



GARANTIE



Description/Description/Descripción

Corps laiton. Anse acier cémenté nickelé. Mécanisme à goupilles. Simple ancrage. 2 clés par cadenas.

Brass body. Hardened nickel plated steel shackle. Pin mechanism. Simple locking. 2 keys per padlock.

Cuerpo de latón. Arco de acero cementado niquelado. Mecanismo de pasadores. Simple anclaje. 2 llaves por candado.

Finition/Finish/Acabado

Laiton poli. Nickel satin.

Polished brass. Nickel plated

Latón pulido. Niquelado

Utilisation/Use/Utilización

Intérieur

Indoor

Interior

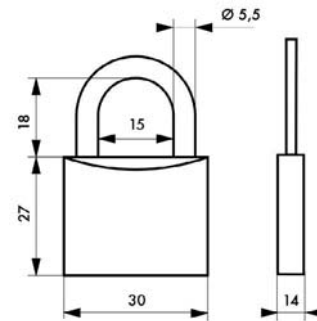

Designation	Boite	Colis.	Prix	Sachet	Colis.	Prix	Brochable					Colis.	Prix
							France	Euro 1	Euro 2	Euro 3	Euro 4		
Lot de 2 cadenas 30 mm laiton poli LOVE 1 (ange / démon)	-	-	-	-	-	-	00109601 [E] [NS]	-	-	-	-	10	-
Lot de 2 cadenas 30 mm laiton poli LOVE 2 (elle / lui)	-	-	-	-	-	-	00109602 [E] [NS]	-	-	-	-	10	-
Lot de 2 cadenas 30 mm laiton poli LOVE 3 (pas lun / sans autre)	-	-	-	-	-	-	00109603 [E] [NS]	-	-	-	-	10	-
Lot de 2 cadenas 30 mm laiton nickel satin LOVE 4 (toi / moi)	-	-	-	-	-	-	00109604 [E] [NS]	-	-	-	-	10	-
Lot de 2 cadenas 30 mm laiton nickel satin LOVE 5 (Cupidon / coeur)	-	-	-	-	-	-	00109605 [E] [NS]	-	-	-	-	10	-
Lot de 2 cadenas 30 mm laiton nickel satin LOVE 6 (colombe / couple)	-	-	-	-	-	-	00109606	-	-	-	-	10	-

[NS] Non stocké/Non-stored/Producto no estocado - [E] Sur stock Europe Zone 1 et Zone 2, nous consulter pour délai d'approvisionnement - [E] Epuisement/Stock depletion/Agotamiento del stock

Cadenas de sûreté / HAPPY LOCKY VOYAGE



NIVEAU DE SÉCURITÉ



GARANTIE

Acier cémenté

Acier

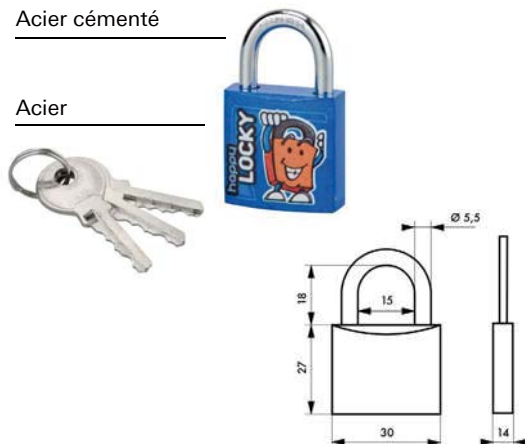

Description/Description/Descripción

Corps acier. Anse acier cémenté nickelé. Mécanisme à goupilles. Simple ancrage. 3 clés acier nickelé.

Steel body. Hardened nickel plated shackle. Pin mechanism. Simple locking. 3 nickel plated steel keys.

Cuerpo de acero. Arco de acero cementado niquelado. Mecanismo de pasadores. Simple anclaje. 3 llaves de acero niquelado.

Finition/Finish/Acabado

Vernis / Varnished / Barnizado

Utilisation/Use/Utilización

Intérieur / Indoor / Interior



X 3

Designation	Boite	Colis.	Prix	Sachet	Colis.	Prix	Brochable					Colis.	Prix
							France	Euro 1	Euro 2	Euro 3	Euro 4		
Cadenas Happy Locky 30 mm (Bleu)	-	-	-	-	-	-	00109001 E NS	-	-	-	-	10	-
Cadenas Happy Locky 30 mm (Rouge) E	-	-	-	-	-	-	00109002 E NS	-	-	-	-	10	-
Cadenas Happy Locky 30 mm (Vert) E	-	-	-	-	-	-	00109003 E NS	-	-	-	-	10	-
Cadenas Happy Locky 30 mm (Violet) E	-	-	-	-	-	-	00109004 E NS	-	-	-	-	10	-

Cadenas de sûreté / CHTIOTE MEUH VOYAGE



NIVEAU DE SÉCURITÉ



GARANTIE

Acier cémenté

Acier

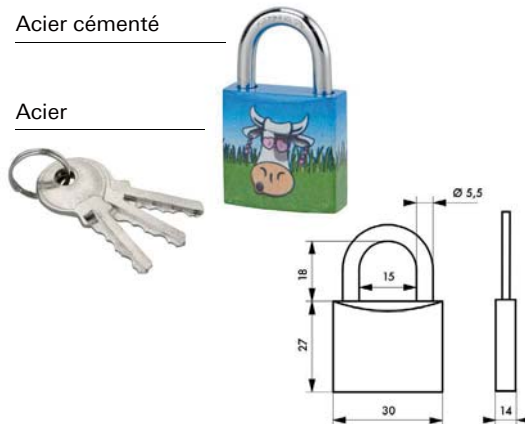

Description/Description/Descripción

Corps acier. Anse acier cémenté nickelé. Mécanisme à goupilles. Simple ancrage. 3 clés acier nickelé.

Steel body. Hardened nickel plated shackle. Pin mechanism. Simple locking. 3 nickel plated steel keys.

Cuerpo de acero. Arco de acero cementado niquelado. Mecanismo de pasadores. Simple anclaje. 3 llaves de acero niquelado.

Finition/Finish/Acabado

Vernis / Varnished / Barnizado

Utilisation/Use/Utilización

Intérieur / Indoor / Interior



X 3

Designation	Boite	Colis.	Prix	Sachet	Colis.	Prix	Brochable					Colis.	Prix
							France	Euro 1	Euro 2	Euro 3	Euro 4		
Cadenas Ch'Tiote Meuh 5 • 30 mm	-	-	-	-	-	-	00109005 E	00109005 E	00109005 E	00109005 E	-	10	-
Cadenas Ch'Tiote Meuh 6 • 30 mm	-	-	-	-	-	-	00109006 E	00109006 E	00109006 E	00109006 E	-	10	-
Cadenas Ch'Tiote Meuh 7 • 30 mm	-	-	-	-	-	-	00109007 E	00109007 E	00109007 E	00109007 E	-	10	-
Cadenas Ch'Tiote Meuh 8 • 30 mm	-	-	-	-	-	-	00109008 E	00109008 E	00109008 E	00109008 E	-	10	-

NS Non stocké/Non-stored/Producto no estocado - Sur stock Europe Zone 1 et Zone 2, nous consulter pour délai d'approvisionnement - E Epuisement/Stock depletion/Agotamiento del stock

Cadenas de sûreté / LINE SPORT VOYAGE



NIVEAU DE SÉCURITÉ



GARANTIE



Description/Description/Descripción

Corps acier. Anse acier cémenté nickelé. Mécanisme à goupilles. Simple ancrage. 3 clés acier nickelé.
Steel body. Hardened nickel plated shackle. Pin mechanism. Simple locking. 3 nickel plated steel keys.

Cuerpo de acero. Arco de acero cementado niquelado. Mecanismo de pasadores. Simple anclaje. 3 llaves de acero niquelado.

Finition/Finish/Acabado

Vernis

Varnished

Barnizado

Utilisation/Use/Utilización

Intérieur

Indoor

Interior

Designation	Boite	Colis.	Prix	Sachet	Colis.	Prix	Brochable					Colis.	Prix
							France	Euro 1	Euro 2	Euro 3	Euro 4		
Cadenas Line Sport 1 • assortis	-	-	-	-	-	-	00109110	-	-	-	-	10	-
Cadenas Line Sport 1 • 30 mm (tennis)	-	-	-	-	-	-	00109010	00109010	00109010	00109010	-	10	-
Cadenas Line Sport 1 • 30 mm (basket)	-	-	-	-	-	-	00109011	00109011	00109011	00109011	-	10	-
Cadenas Line Sport 1 30 mm (rugby)	-	-	-	-	-	-	00109012	00109012	00109012	00109012	-	10	-
Cadenas Line Sport 1 • 30 mm (foot)	-	-	-	-	-	-	00109013	00109013	00109013	00109013	-	10	-
Cadenas Line Sport 2 • 30 mm (karaté)	-	-	-	-	-	-	00109014	00109014	00109014	00109014	-	10	-
Cadenas Line Sport 2 30 mm (natation)	-	-	-	-	-	-	00109015	00109015	00109015	00109015	-	10	-
Cadenas Line Sport 2 • 30 mm (skate)	-	-	-	-	-	-	00109016	00109016	00109016	00109016	-	10	-
Cadenas Line Sport 2 30 mm (surf)	-	-	-	-	-	-	00109017	00109017	00109017	00109017	-	10	-
Cadenas Line Sport 3 30 mm (foot US)	-	-	-	-	-	-	00109627	-	-	-	-	10	-
Cadenas Line Sport 3 30 mm (hockey)	-	-	-	-	-	-	00109628	-	-	-	-	10	-
Cadenas Line Sport 3 30 mm (baseball)	-	-	-	-	-	-	00109629	-	-	-	-	10	-
Cadenas Line Sport 3 30 mm (catch)	-	-	-	-	-	-	00109630	-	-	-	-	10	-

NS Non stocké/Non-stored/Producto no estocado - ☐ Sur stock Europe Zone 1 et Zone 2, nous consulter pour délai d'approvisionnement - E Epuisement/Stock depletion/Agotamiento del stock

Cadenas de sûreté / ASTROLOCK VOYAGE



NIVEAU DE SÉCURITÉ



GARANTIE

Acier cémenté

Acier

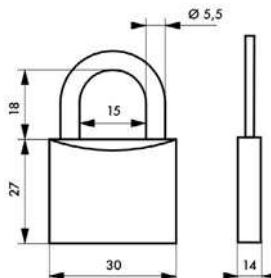

X 3



Description/Description/Descripción

Corps acier. Anse acier cémenté nickelé. Mécanisme à goupilles. Simple ancrage. 3 clés acier nickelé.

Steel body. Hardened nickel plated shackle. Pin mechanism. Simple locking. 3 nickel plated steel keys.

Cuerpo de acero. Arco de acero cementado niquelado. Mecanismo de pasadores. Simple anclaje. 3 llaves de acero niquelado.

Finition/Finish/Acabado

Vernis

Varnished

Barnizado

Utilisation/Use/Utilización

Intérieur

Indoor

Interior

Designation	Boite	Colis.	Prix	Sachet	Colis.	Prix	Brochable					Colis.	Prix
							France	Euro 1	Euro 2	Euro 3	Euro 4		
Cadenas Astrolock 30 mm (belier)	-	-	-	-	-	-	00109612 [E] [NS]	-	-	-	-	10	-
Cadenas Astrolock 30 mm (taureau) E	-	-	-	-	-	-	00109613 [E] [NS]	-	-	-	-	10	-
Cadenas Astrolock 30 mm (gémeaux) E	-	-	-	-	-	-	00109617 [E] [NS]	-	-	-	-	10	-
Cadenas Astrolock 30 mm (cancer) E	-	-	-	-	-	-	00109616 [E] [NS]	-	-	-	-	10	-
Cadenas Astrolock 30 mm (lion) E	-	-	-	-	-	-	00109611 [E] [NS]	-	-	-	-	10	-
Cadenas Astrolock 30 mm (vierge) E	-	-	-	-	-	-	00109615 [E] [NS]	-	-	-	-	10	-
Cadenas Astrolock 30 mm (balance) E	-	-	-	-	-	-	00109607 [E] [NS]	-	-	-	-	10	-
Cadenas Astrolock 30 mm (scorpion) E	-	-	-	-	-	-	00109610 [E] [NS]	-	-	-	-	10	-
Cadenas Astrolock 30 mm (sagittaire) E	-	-	-	-	-	-	00109608 [E] [NS]	-	-	-	-	10	-
Cadenas Astrolock 30 mm (capricorne) E	-	-	-	-	-	-	00109618	-	-	-	-	10	-
Cadenas Astrolock 30 mm (verseau) E	-	-	-	-	-	-	00109609	-	-	-	-	10	-
Cadenas Astrolock 30 mm (poisson) E	-	-	-	-	-	-	00109614	-	-	-	-	10	-

[NS] Non stocké/Non-stored/Producto no estocado - [E] Sur stock Europe Zone 1 et Zone 2, nous consulter pour délai d'approvisionnement - [E] Epuisement/Stock depletion/Agotamiento del stock

Cadenas de sûreté / GREEN IDEA VOYAGE



NIVEAU DE SÉCURITÉ



GARANTIE



Acier cémenté

Acier

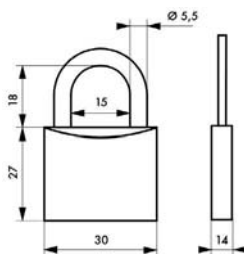

Description/Description/Descripción

Corps acier. Anse acier cémenté nickelé.
Mécanisme à goupilles. Simple ancrage. 3 clés acier nickelé.

Steel body. Hardened nickel plated shackle.

Pin mechanism. Simple locking. 3 nickel plated steel keys.

Cuerpo de acero. Arco de acero cementado níquelado. Mecanismo de pasadores. Simple anclaje. 3 llaves de acero níquelado.

Finition/Finish/Acabado

Vernis / Varnished / Barnizado

Utilisation/Use/Utilización

Intérieur / Indoor / Interior



X 3

Designation	Boite	Colis.	Prix	Sachet	Colis.	Prix	Brochable					Colis.	Prix
							France	Euro 1	Euro 2	Euro 3	Euro 4		
Cadenas Green Idea Bananier • 30 mm	-	-	-	-	-	-	00109619 [E] [NS]	-	-	-	-	10	-
Cadenas Green Idea Bambou • 30 mm	-	-	-	-	-	-	00109620 [E] [NS]	-	-	-	-	10	-
Cadenas Green Idea Chanvre • 30 mm	-	-	-	-	-	-	00109621 [E] [NS]	-	-	-	-	10	-
Cadenas Green Idea Marguerite • 30 mm	-	-	-	-	-	-	00109622 [E] [NS]	-	-	-	-	10	-

Cadenas de sûreté / EXTRA LOCK VOYAGE



NIVEAU DE SÉCURITÉ



GARANTIE



Acier cémenté

Acier

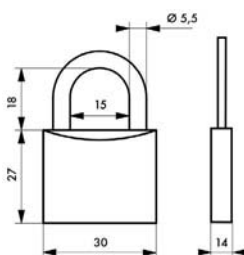

Description/Description/Descripción

Corps acier. Anse acier cémenté nickelé.
Mécanisme à goupilles. Simple ancrage. 3 clés acier nickelé.

Steel body. Hardened nickel plated shackle.

Pin mechanism. Simple locking. 3 nickel plated steel keys.

Cuerpo de acero. Arco de acero cementado níquelado. Mecanismo de pasadores. Simple anclaje. 3 llaves de acero níquelado.

Finition/Finish/Acabado

Vernis / Varnished / Barnizado

Utilisation/Use/Utilización

Intérieur / Indoor / Interior



X 3

Designation	Boite	Colis.	Prix	Sachet	Colis.	Prix	Brochable					Colis.	Prix
							France	Euro 1	Euro 2	Euro 3	Euro 4		
Cadenas Extra Lock 30 mm (Speedcom)	-	-	-	-	-	-	00109623 [E] [NS]	-	-	-	-	10	-
Cadenas Extra Lock 30 mm (Bulmlecom) E	-	-	-	-	-	-	00109624 [E] [NS]	-	-	-	-	10	-
Cadenas Extra Lock 30 mm (Electricom) E	-	-	-	-	-	-	00109625 [E] [NS]	-	-	-	-	10	-
Cadenas Extra Lock 30 mm (Explocm) E	-	-	-	-	-	-	00109626 [E] [NS]	-	-	-	-	10	-

[NS] Non stocké/Non-stored/Producto no estocado - [E] Sur stock Europe Zone 1 et Zone 2, nous consulter pour délai d'approvisionnement - [E] Epuisement/Stock depletion/Agotamiento del stock

Cadenas de sûreté / BETTER WORLD VOYAGE



NIVEAU DE SÉCURITÉ



GARANTIE



Acier cémenté

Acier

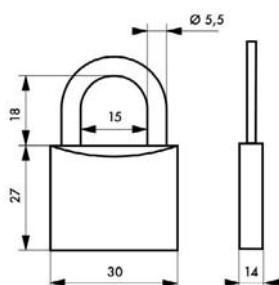

Description/Description/Descripción

Corps acier. Anse acier cémenté nickelé.
Mécanisme à goupilles. Simple ancrage. 3 clés acier nickelé.

*Steel body. Hardened nickel plated shackle.
Pin mechanism. Simple locking. 3 nickel plated steel keys.*

Cuerpo de acero. Arco de acero cementado níquelado. Mecanismo de pasadores. Simple anclaje. 3 llaves de acero níquelado.

Finition/Finish/Acabado

Vernis / Varnished / Barnizado

Utilisation/Use/Utilización

Intérieur / Indoor / Interior



X 3

Designation	Boite	Colis.	Prix	Sachet	Colis.	Prix	Brochable					Colis.	Prix
							France	Euro 1	Euro 2	Euro 3	Euro 4		
Cadenas Better World 30 mm	-	-	-	-	-	-	00109631 NS	-	-	-	-	10	-
Cadenas Better City 30 mm	-	-	-	-	-	-	00109632 E NS	-	-	-	-	10	-
Cadenas Better Life 30 mm	-	-	-	-	-	-	00109633 E NS	-	-	-	-	10	-
Cadenas Better Idea 30 mm	-	-	-	-	-	-	00109634 E NS	-	-	-	-	10	-

Cadenas de sûreté / FASHION LEATHER VOYAGE



NIVEAU DE SÉCURITÉ



GARANTIE



Acier cémenté

Acier

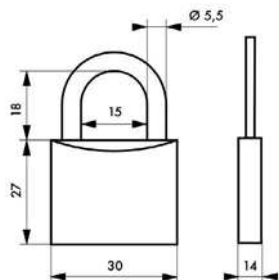

Description/Description/Descripción

Corps acier. Anse acier cémenté nickelé.
Mécanisme à goupilles. Simple ancrage. 3 clés acier nickelé.

*Steel body. Hardened nickel plated shackle.
Pin mechanism. Simple locking. 3 nickel plated steel keys.*

Cuerpo de acero. Arco de acero cementado níquelado. Mecanismo de pasadores. Simple anclaje. 3 llaves de acero níquelado.

Finition/Finish/Acabado

Cuir / Leather / Cuero

Utilisation/Use/Utilización

Bagage / Luggage / Equipaje



X 3

Designation	Boite	Colis.	Prix	Sachet	Colis.	Prix	Brochable					Colis.	Prix
							France	Euro 1	Euro 2	Euro 3	Euro 4		
Cadenas Fashion Leather 30 mm (blanc)	-	-	-	-	-	-	00109018 E	00109018 E	00109018 E	00109018 E	-	10	-
Cadenas Fashion Leather 30 mm (noir)	-	-	-	-	-	-	00109019 E	00109019 E	00109019 E	00109019 E	-	10	-
Cadenas Fashion Leather 30 mm (rouge)	-	-	-	-	-	-	00109020 E	00109020 E	00109020 E	00109020 E	-	10	-
Cadenas Fashion Leather 30 mm (marron)	-	-	-	-	-	-	00109021 E	00109021 E	00109021 E	00109021 E	-	10	-

NS Non stocké/Non-stored/Producto no estocado - E Sur stock Europe Zone 1 et Zone 2, nous consulter pour délai d'approvisionnement - E Epuisement/Stock depletion/Agotamiento del stock

Cadenas de sûreté / GRAFFITI VOYAGE



NIVEAU DE SÛRETÉ



GARANTIE

Surface d'écriture pour personnaliser votre cadenas



Acier nickelé

Alliage moulé

Combinaison modifiable

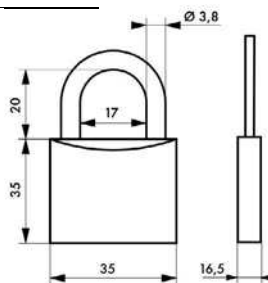

Description/Description/Descripción

Corps alliage moulé. Anse acier nickelé. Mécanisme à 3 viroles. Combinaison modifiable.

Moulded alloy body. Nickel plated steel shackle. 3 dial mechanism. Resettable combination.

Cuerpo de aleación moldeada. Arco de acero niquelado. Mecanismo con 3 virolas. Combinación modificable.

Finition/Finish/Acabado

Couleurs assorties

Assorted colors

Colores surtidos

Utilisation/Use/Utilización

Bagage

Luggage

Casilleros



CODE MODIFIABLE

Designation	Boite	Colis.	Prix	Sachet	Colis.	Prix	Brochable					Colis.	Prix
							France	Euro 1	Euro 2	Euro 3	Euro 4		
Cadenas GRAFFITI 35 mm 3 viroles couleurs assorties	-	-	-	-	-	-	00171026	00193908 NS	00192908 NS	00194908	-	10	-

Cadenas de sûreté / SWISH VOYAGE



NIVEAU DE SÛRETÉ



GARANTIE

Alliage

Alliage moulé

Combinaison modifiable



Description/Description/Descripción

Corps alliage moulé. Anse alliage moulé. Mécanisme à 3 viroles. Combinaison modifiable, 1 000 combinaisons possibles.

Moulded alloy body. Moulded alloy shackle. 3 dial mechanism. Resettable combination, 1 000 possible combinations.

Cuerpo de aleación moldeada. Arco de aleación moldeada. Mecanismo con 3 virolas. Combinación modificable, 1.000 combinaciones posibles.

Finition/Finish/Acabado

Noir, nickelé, doré / *Black, nickel or gold plated* / Negro, niquelado o dorado

Utilisation/Use/Utilización

Bagage / *Luggage* / Equipaje



CODE MODIFIABLE

Designation	Boite	Colis.	Prix	Sachet	Colis.	Prix	Brochable					Colis.	Prix
							France	Euro 1	Euro 2	Euro 3	Euro 4		
Cadenas SWISH combinaison modifiable noir	00001180	10	-	-	-	-	00101180	00193048 NS	00192048 NS	00194048	-	10	-
Cadenas SWISH combinaison modifiable nickelé	00001181	10	-	-	-	-	00101181	00193047 NS	00192047 NS	00194047	-	10	-
Cadenas SWISH combinaison modifiable doré	00001182	10	-	-	-	-	00101182	00193046 NS	00192046 NS	00194046	-	10	-
COQUE de 3 cadenas SWISH combinaison modifiable noir	-	-	-	-	-	-	00131180	-	-	00194049	-	10	-

NS Non stocké/Non-stored/Producto no estocado - S Sur stock Europe Zone 1 et Zone 2, nous consulter pour délai d'approvisionnement - E Epuisement/Stock depletion/Agotamiento del stock

Cadenas de sûreté / BORA BORA VOYAGE



NIVEAU DE SÉCURITÉ



GARANTIE



CODE MODIFIABLE



Acier nickelé

Alliage moulé

Combinaison modifiable

	171012	171013
	27	30
	38	45
	13	13
	23	24
	11,5	13
	3,5	3,5

Description/Description/Descripción

Corps alliage moulé. Anse acier nickelé. Mécanisme à viroles. Combinaison modifiable.

Moulded alloy body. Nickel plated steel shackle. Dial mechanism. Resettable combination.

Cuerpo de aleación moldeada. Arco de acero niquelado. Mecanismo con virolas. Combinación modificable.

Finition/Finish/Acabado

Couleurs assorties

Assorted colors

Colores surtidos

Utilisation/Use/Utilización

Bagage

Luggage

Equipaje

Designation	Boite	Colis.	Prix	Sachet	Colis.	Prix	Brochable					Colis.	Prix
							France	Euro 1	Euro 2	Euro 3	Euro 4		
Cadenas BORA BORA 27 mm 3 viroles modif.	-	-	-	-	-	-	00171012	00193277 	00192277 	00194277	-	10	-
Cadenas BORA BORA 30 mm 4 viroles modif.	-	-	-	-	-	-	00171013	00193278 	00192278 	00194278	-	10	-

Cadenas de sûreté / PAPEETE VOYAGE



NIVEAU DE SÉCURITÉ



GARANTIE



CODE MODIFIABLE



Acier nickelé

Alliage moulé

Combinaison modifiable

	171014	171015
	25	30
	33	47
	10,5	14
	20	27
	10,5	14
	3	5

Description/Description/Descripción

Corps alliage moulé. Anse acier nickelé. Mécanisme à viroles. Combinaison modifiable.

Moulded alloy body. Nickel plated steel shackle. Dial mechanism. Resettable combination.

Cuerpo de aleación moldeada. Arco de acero niquelado. Mecanismo con virolas. Combinación modificable.

Finition/Finish/Acabado

Couleurs assorties

Assorted colors

Colores surtidos

Utilisation/Use/Utilización

Bagage

Luggage

Equipaje

Designation	Boite	Colis.	Prix	Sachet	Colis.	Prix	Brochable					Colis.	Prix
							France	Euro 1	Euro 2	Euro 3	Euro 4		
Cadenas PAPEETE 25 mm 3 viroles modif.	-	-	-	-	-	-	00171014	00193279 	00192279 	00194279	-	10	-
Cadenas PAPEETE 30 mm 4 viroles modif.	-	-	-	-	-	-	00171015	00193280 	00192280 	00194280	-	10	-

Non stocké/Non-stored/Producto no estocado - Sur stock Europe Zone 1 et Zone 2, nous consulter pour délai d'approvisionnement - Epuisement/Stock depletion/Agotamiento del stock

Cadenas de sûreté / Compact 01 - 02 - 03

VOYAGE



NIVEAU DE SÉCURITÉ



GARANTIE



CODE MODIFIABLE



Acier nickelé

Alliage moulé

Combinaison modifiable

00199317



00037300



00037600

Description/Description/Descripción

Corps alliage moulé. Anse acier nickelé. Mécanisme à 3 viroles. Combinaison modifiable, 1 000 combinaisons possibles.

Moulded alloy body. Nickel plated steel shackle. 3 dial mechanism. Resettable combination, 1 000 possible combinations.

Cuerpo de aleación moldeada. Arco de acero niquelado. Mecanismo con 3 virolas. Combinación modificable, 1.000 combinaciones posibles.

Finition/Finish/Acabado

Noir

Black

Negro

Utilisation/Use/Utilización

Bagage

Luggage

Equipaje

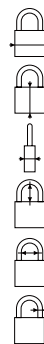

	099317	037300	037600
22	22	21	31
32	32	38	45
11,5	11,5	11,5	13,5
20	20	18	23
9	9	9	14
3	3	3	5

Designation	Boite	Colis.	Prix	Sachet	Colis.	Prix	Brochable					Colis.	Prix
							France	Euro 1	Euro 2	Euro 3	Euro 4		
Cad.COMPACT 01 • 22 mm combinaison modifiable	-	-	-	-	-	-	00199317	-	-	00194571	-	10	-
Cad.COMPACT 02 • 21 mm combinaison modifiable	-	-	-	-	-	-	00137300	-	-	00194572	-	10	-
Cad.COMPACT 03 • 31 mm combinaison modifiable	-	-	-	00937600	20	-	00137600	00193044 NS	00192044 NS	00194044	-	10	-
COQUE de 2 cadenas COMPACT 02 • 21 mm	-	-	-	-	-	-	00102373	00193045 NS	00192045 NS	00194045	-	10	-

NS Non stocké/Non-stored/Producto no estocado - ☐ Sur stock Europe Zone 1 et Zone 2, nous consulter pour délai d'approvisionnement - ☒ Epuisement/Stock depletion/Agotamiento del stock

Cadenas à câble / MOOREA VOYAGE



NIVEAU DE SÉCURITÉ



GARANTIE



CODE MODIFIABLE

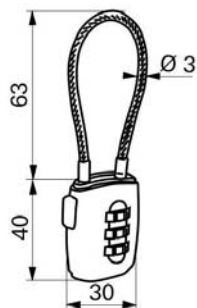
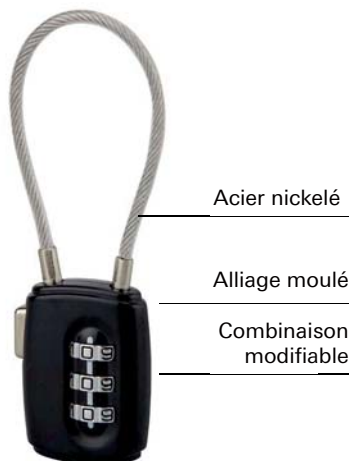

Description/Description/Descripción

Corps alliage moulé. Câble acier Ø 3 mm long. 125mm. Mécanisme à 3 viroles. Combinaison modifiable.

Moulded alloy body. Steel cable Ø 3 mm. length 125 mm. Dial mechanism. Resettable combination.

Descripción. Cuerpo de aleación moldeada. Cable de acero Ø 3 mm, longitud 125 mm. Mecanismo con virolas. Combinación modificable.

Finition/Finish/Acabado

Couleurs assorties

Assorted colors

Colores surtidos

Utilisation/Use/Utilización

Bagage

Luggage

Equipaje

Designation	Boîte	Colis.	Prix	Sachet	Colis.	Prix	Brochable					Colis.	Prix
							France	Euro 1	Euro 2	Euro 3	Euro 4		
Cadenas à câble MOOREA à combinaison. modifiable	-	-	-	-	-	-	00171011	00193282 NS	00192282 NS	00194282	-	10	-

Cadenas à câble / EXTENSO VOYAGE



NIVEAU DE SÉCURITÉ



GARANTIE



CODE MODIFIABLE

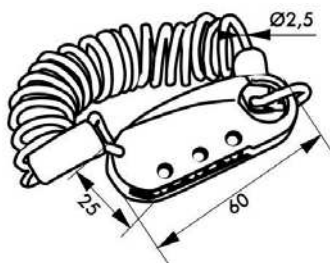
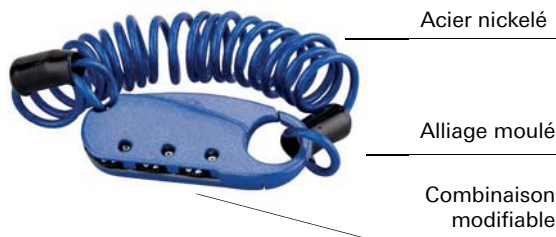

Description/Description/Descripción

Corps alliage moulé. Câble acier Ø 2,5 mm long. 1,00 m. Mécanisme à 3 viroles. Combinaison modifiable.

Moulded alloy body. Steel cable Ø 2,5 mm length 1,00 m. Dial mechanism - Resettable combination.

Cuerpo de aleación moldeada. Cable de acero Ø 2,5 mm longitud 1,00 m. Mecanismo con virolas - Combinación modificable.

Finition/Finish/Acabado

Couleurs assorties

Assorted colors

Colores surtidos

Utilisation/Use/Utilización

Bagage

Luggage

Equipaje

Designation	Boîte	Colis.	Prix	Sachet	Colis.	Prix	Brochable					Colis.	Prix
							France	Euro 1	Euro 2	Euro 3	Euro 4		
Cadenas à câble EXTENSO à combinaison. modifiable	-	-	-	-	-	-	00171010	00193281 NS	00192281 NS	00194281	-	10	-

NS Non stocké/Non-stored/Producto no estocado - Sur stock Europe Zone 1 et Zone 2, nous consulter pour délai d'approvisionnement - E Epuisement/Stock depletion/Agotamiento del stock

Cadenas de sûreté / FANTASY VOYAGE



NIVEAU DE SÛRETÉ



GARANTIE



CODE
MODIFIABLE



00108004



00108001



00108009



00108008

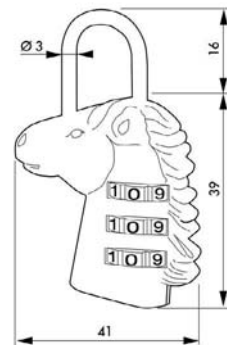
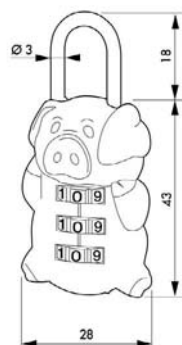
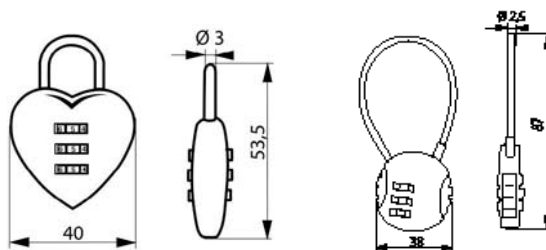

Description/Description/Descripción

Corps alliage moulé. Anse acier nickelé. Mécanisme à 3 viroles. Combinaison modifiable.

Moulded alloy body. Nickel plated steel shackle. Dial mechanism. Resettable combination.

Cuerpo de aleación moldeada. Arco de acero cementado niquelado. Mecanismo con virolas. Combinación modificable.

Utilisation/Use/Utilización

Bagage

Luggage

Equipaje

Designation	Boite	Colis.	Prix	Sachet	Colis.	Prix	Brochable					Colis.	Prix
							France	Euro 1	Euro 2	Euro 3	Euro 4		
Cadenas Fantasy 1 à combinaison modifiable	-	-	-	-	-	-	00108001	00108001	00108001	00108001	-	10	-
Cadenas Fantasy 4 à combinaison modifiable	-	-	-	-	-	-	00108004	00108004	00108004	00108004	-	10	-
Cadenas Fantasy 8 à combinaison modifiable	-	-	-	-	-	-	00108008	00108008	00108008	00108008	-	10	-
Cadenas Fantasy 9 à combinaison modifiable	-	-	-	-	-	-	00108009	00108009	00108009	00108009	-	10	-

Ⓜ Non stocké/Non-stored/Producto no estocado - Ⓜ Sur stock Europe Zone 1 et Zone 2, nous consulter pour délai d'approvisionnement - Ⓜ Epuisement/Stock depletion/Agotamiento del stock

Cadenas de sûreté / NOMAD VOYAGE



NIVEAU DE SÉCURITÉ



GARANTIE



CODE
MODIFIABLE



00108010



00108007



00108003



00108011

Description/Description/Descripción

Corps alliage moulé. Anse acier nickelé. Mécanisme à 3 viroles. Combinaison modifiable.

Moulded alloy body. Nickel plated steel shackle. Dial mechanism. Resettable combination.

Cuerpo de aleación moldeada. Arco de acero cementado niquelado. Mecanismo con virolas. Combinación modificable.

Utilisation/Use/Utilización

Intérieur

Indoor

Interior

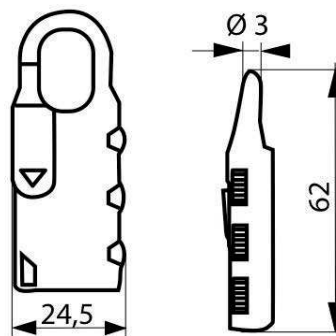

Designation	Boite	Colis.	Prix	Sachet	Colis.	Prix	Brochable					Colis.	Prix
							France	Euro 1	Euro 2	Euro 3	Euro 4		
Cadenas Nomad à combinaison modifiable	-	-	-	-	-	-	00108003	00108003 ☑	00108003 ☑	00108003	-	10	-
Cadenas Nomad à combinaison modifiable	-	-	-	-	-	-	00108007	00108007 ☑	00108007 ☑	00108007	-	10	-
Cadenas Nomad à combinaison modifiable	-	-	-	-	-	-	00108010	00108010 ☑	00108010 ☑	00108010	-	10	-
Cadenas Nomad à combinaison modifiable	-	-	-	-	-	-	00108011 [E]	00108011 [E] ☑	00108011 [E] ☑	00108011 [E]	-	10	-

☑ Non stocké/Non-stored/Producto no estocado - ☑ Sur stock Europe Zone 1 et Zone 2, nous consulter pour délai d'approvisionnement - [E] Epuisement/Stock depletion/Agotamiento del stock

Mousqueton / FUNNY VOYAGE



NIVEAU DE SÉCURITÉ



GARANTIE



CODE
MODIFIABLE



Alliage moulé

Combinaison
modifiable

Description/Description/Descripción

Corps alliage moulé. Anse Ø 7 mm. Mécanisme à 3 viroles.
Combinaison modifiable.

Moulded alloy body. Shackle Ø 7 mm. Dial mechanism.

Resettable combination

Cuerpo de aleación moldeada. Arco Ø 7 mm. Mecanismo
con virolas. Combinación modificable.

Finition/Finish/Acabado

Couleurs assorties

Assorted colors

Colores surtidos

Utilisation/Use/Utilización

Fashion et fantaisie

Fashion and fancy

Moda y fantasía

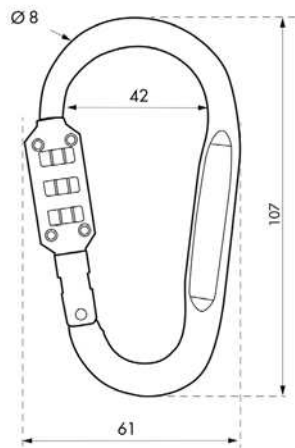

Designation	Boite	Colis.	Prix	Sachet	Colis.	Prix	Brochable					Colis.	Prix
							France	Euro 1	Euro 2	Euro 3	Euro 4		
Mousqueton FUNNY à combinaison	-	-	-	00971018	10	-	00171018	00193286 NS	00192286 NS	00194286	-	10	-

NS Non stocké/Non-stored/Producto no estocado - Sur stock Europe Zone 1 et Zone 2, nous consulter pour délai d'approvisionnement - E Epuisement/Stock depletion/Agotamiento del stock

MOUSQUETON VOYAGE



NIVEAU DE SÉCURITÉ



GARANTIE



Description/Description/Descripción

Mousqueton aluminium.

Aluminium snap hook.

Mosquetón de aluminio.

Finition/Finish/Acabado

Couleurs assorties

Assorted colors

Colores surtidos

Utilisation/Use/Utilización

Fashion et fantaisie

Fashion and fancy

Moda y fantasía

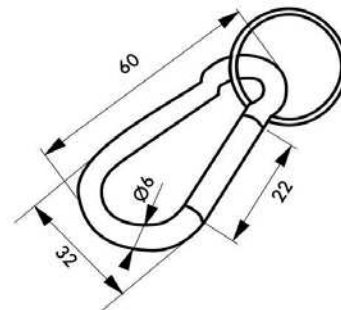

Designation	Boite	Colis.	Prix	Sachet	Colis.	Prix	Brochable				Colis.	Prix	
							France	Euro 1	Euro 2	Euro 3			Euro 4
MOUSQUETON aluminium Ø 6 x 60 mm couleurs assorties (2 pièces sous coque)	00006206	10	-	00906206	10	-	00106206	00193042 <small>NS</small>	00192042 <small>NS</small>	00194042	-	10	-

NS Non stocké/Non-stored/Producto no estocado - ■ Sur stock Europe Zone 1 et Zone 2, nous consulter pour délai d'approvisionnement - E Epuïsement/Stock depletion/Agotamiento del stock

Cadenas de sûreté / RUCK VOYAGE



NIVEAU DE SÉCURITÉ



GARANTIE



Acier nickelé

Laiton



X 2

Description/Description/Descripción
Corps laiton monobloc. Anse acier nickelé. Mécanisme à goupilles. Protection contre le perçage et le crochetage par 2 goupilles acier traité. Simple verrouillage. 2 clés. *One piece brass body. Nickel-plated steel shackle. Pins mechanism. Protection against drilling and picking by 2 pins in treated steel. Simple locking. 2 keys.*

Cuerpo de latón monobloque. Arco de acero niquelado. Mecanismo de pasadores. Protección contra la perforación y el forzamiento mediante 2 pasadores de acero tratado. Bloqueo simple. 2 llaves.

Finition/Finish/Acabado

Laiton poli / Polished brass / Latón pulido

Utilisation/Use/Utilización

Bagage / Luggage / Equipaje

Designation	Boite	Colis.	Prix	Sachet	Colis.	Prix	Brochable					Colis.	Prix
							France	Euro 1	Euro 2	Euro 3	Euro 4		
Cadenas RUCK 15 mm	-	-	-	-	-	-	00182115	00193090 NS	00192090 NS	00194090	-	10	-
Cadenas RUCK 20 mm	-	-	-	-	-	-	00182120	00193091 NS	00192091 NS	00194091	-	10	-
Cadenas RUCK 25 mm	-	-	-	-	-	-	00182125	00193092 NS	00192092 NS	00194092	-	10	-

Cadenas de sûreté / MACH 2 VOYAGE



NIVEAU DE SÉCURITÉ



GARANTIE



Acier cémenté
nickelé

Laiton

	20 mm	25 mm
	21	25
	20,5	25,5
	11	13
	14,5	16
	10	14
	3,5	4
Goup.	3	3



X 2

Description/Description/Descripción
Corps laiton monobloc. Anse acier cémenté nickelé. Mécanisme à goupilles. 2 clés acier nickelé *Compact brass body. Hardened nickel plated steel shackle. Pin mechanism. 2 nickel plated steel keys.*
Cuerpo de latón monobloque. Arco de acero cementado niquelado. Mecanismo de pasadores. 2 llaves de acero niquelado.

personnalisation (nous consulter). Clés supplémentaires sur numéro. Cadenas sur numéro imposé et sur même combinaison.

Customer's brand can be engraved. (on request). Extra keys under requested number possible. Delivery of padlocks under requested number and keyed alike.

Posibilidad de personalización (consúltenos). Llaves suplementarias sobre número. Candado con número impuesto y con la misma combinación.

Utilisation/Use/Utilización

Bagage / Luggage / Equipaje

Finition/Finish/Acabado

Laiton poli / Polished brass / Latón pulido

Version/Option/Versión

Clés laiton pour taille 20 mm. Possibilité de

Designation	Boite	Colis.	Prix	Sachet	Colis.	Prix	Brochable					Colis.	Prix
							France	Euro 1	Euro 2	Euro 3	Euro 4		
MACH 2 • 20 mm	00063201	10	-	-	-	-	-	-	-	-	-	-	-
MACH 2 • 25 mm	00063251	10	-	-	-	-	00163251	-	-	00194577	-	10	-

Cadenas de sûreté / MACH 2

VOYAGE

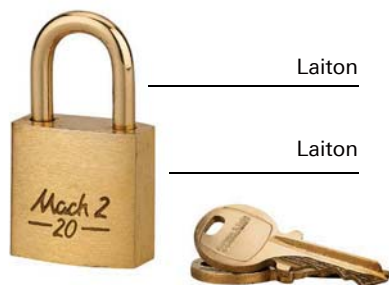

Laiton

Laiton

	20 mm	25 mm
	21	25
	20,5	25,5
	11	13
	14,5	16
	10	14
	3,5	4
	sup.	3

Description/Description/Descripción

Corps laiton monobloc. Anse laiton. Mécanisme à goupilles. 2 clés laiton

Compact brass body. Brass shackle. Pin mechanism. 2 brass keys.

Cuerpo de latón monobloque. Arco de latón. Mecanismo de pasadores. 2 llaves de latón.

Finition/Finish/Acabado

Laiton poli / Polished brass / Latón pulido

Version/Option/Versión

Possibilité de personnalisation (nous consulter). Clés supplémentaires sur numéro. Cadenas sur numéro imposé et sur même combinaison.

Customer's brand can be engraved. (on request). Extra keys under requested number possible. Delivery of padlocks under requested number and keyed alike.

Possibilidad de personalización (consultenos). Llaves suplementarias sobre número. Candado con número impuesto y con la misma combinación.

Utilisation/Use/Utilización

Bagage / Luggage / Equipaje



NIVEAU DE SÉCURITÉ



GARANTIE



X 2

Designation	Boite	Colis.	Prix	Sachet	Colis.	Prix	Brochable					Colis.	Prix
							France	Euro 1	Euro 2	Euro 3	Euro 4		
MACH 2 • 20 mm	00063202	10	-	-	-	-	-	-	-	-	-	-	-
MACH 2 • 25 mm	00063252	10	-	-	-	-	-	-	-	-	-	-	-

Cadenas de sûreté / TSA

VOYAGE



Cadenas agréés par l'administration des transports internationaux. Ouverture possible par les douaniers avec une clé spéciale sans détérioration du bagage.



NIVEAU DE SÉCURITÉ



GARANTIE



X 2x2



Acier nickelé

Laiton

Description/Description/Descripción

Corps laiton monobloc gainé PVC. Anse acier nickelé. Mécanisme à goupilles. Simple ancrage. 2 x 2 clés acier nickelé.

Compact brass body protected by a PVC shell. Nickel plated steel shackle. Pin mechanism. Simple locking. 2x2 nickel plated steel keys.

Cuerpo de latón monobloque con revestimiento de PVC. Arco de acero niquelado. Mecanismo de pasadores.

Simple anclaje. 2x2 llaves de acero niquelado

Finition/Finish/Acabado

PVC - noir / PVC - black / PVC - negro

Utilisation/Use/Utilización

Bagage / Luggage / Equipaje

Designation	Boite	Colis.	Prix	Sachet	Colis.	Prix	Brochable					Colis.	Prix
							France	Euro 1	Euro 2	Euro 3	Euro 4		
Lot de 2 cadenas TSA 25 mm 4 clés identiques	-	-	-	-	-	-	00171025 E	00193290 E NS	00192290 E NS	00194290 E	-	10	-

NS Non stocké/Non-stored/Producto no estocado - NS Sur stock Europe Zone 1 et Zone 2, nous consulter pour délai d'approvisionnement - E Epuisement/Stock depletion/Agotamiento del stock

Cadenas de sûreté / 158 - 208

VOYAGE



NIVEAU DE SÉCURITÉ



GARANTIE



Acier nickelé

Laiton

	000158	000208
	15	21
	27	29,5
	8,7	10
	15	22,5
	7,5	9
	2,5	3

Combinaison modifiable

Description/Description/Descripción

Corps laiton monobloc. Anse acier nickelé. Mécanisme à 3 viroles. Combinaison modifiable

Compact brass body. Nickel plated steel shackle. 3 Dial mechanism. Resettable combination.

Cuerpo de latón monobloque. Arco de acero niquelado. Mecanismo con 3 virolas. Combinación modificable.

Finition/Finish/Acabado

Laiton poli / *Polished brass* / Latón pulido

Versión/Option/Versión

Anse laitonné. / *Brass plated shackle.*

Arco latonado.

Utilisation/Use/Utilización

Bagage / *Luggage* / Equipaje



CODE MODIFIABLE

Designation	Boite	Colis.	Prix	Sachet	Colis.	Prix	Brochable					Colis.	Prix
							France	Euro 1	Euro 2	Euro 3	Euro 4		
Cadenas 158 • 15 mm à combinaison modifiable	-	-	-	00900158	10	-	00100158	00193910 NS	00192910 NS	00194910	-	10	-
Cadenas 208 • 21 mm à combinaison modifiable	-	-	-	00900208	10	-	00100208	00193705 NS	00192705 NS	00194705	-	10	-
Cadenas 208 • 21 mm à comb. modifiable - anse laitonné	-	-	-	-	-	-	00100209	00193909 NS	00192909 NS	00194037	-	10	-

Cadenas de sûreté / VENUS

VOYAGE



NIVEAU DE SÉCURITÉ



GARANTIE



Acier nickelé

Alliage

Combinaison modifiable

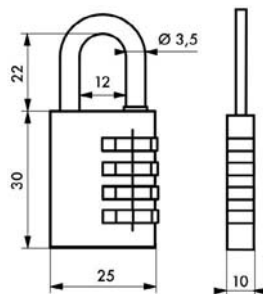

Description/Description/Descripción

Corps alliage. Anse acier nickelé. Mécanisme à 3 viroles. Combinaison modifiable.

Alloy body. Nickel plated steel shackle. 3 Dial mechanism. Resettable combination.

Cuerpo de aleación. Arco de acero niquelado. Mecanismo con 3 virolas. Combinación modificable.

Finition/Finish/Acabado

Laitonné

Brass plated.

Latonado

Utilisation/Use/Utilización

Bagage

Luggage

Equipaje



CODE MODIFIABLE

Designation	Boite	Colis.	Prix	Sachet	Colis.	Prix	Brochable					Colis.	Prix
							France	Euro 1	Euro 2	Euro 3	Euro 4		
Cadenas VENUS 25 mm à combinaison modifiable	-	-	-	00990800	10	-	00190800	00193314 NS	00192314 NS	00194314	-	10	-

NS Non stocké/Non-stored/Producto no estocado - S Sur stock Europe Zone 1 et Zone 2, nous consulter pour délai d'approvisionnement - E Epuisement/Stock depletion/Agotamiento del stock

Cadenas de sûreté / CLUB 2 VOYAGE



NIVEAU DE SÉCURITÉ



GARANTIE



Acier nickelé

Alliage moulé

Combinaison modifiable

Description/Description/Descripción
Corps alliage moulé. Anse acier nickelé. Mécanisme à 3 viroles. Combinaison modifiable.

Moulded alloy body. Nickel plated steel shackle. 3 Dial mechanism. Resettable combination.

Cuerpo de aleación moldeada. Arco de acero niquelado. Mecanismo con 3 virolas. Combinación modificable.

Finition/Finish/Acabado

Argent

Silver

Plata

Utilisation/Use/Utilización

Bagage

Luggage

Equipaje



CODE MODIFIABLE

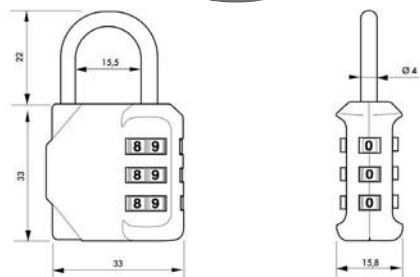

Designation	Boîte	Colis.	Prix	Sachet	Colis.	Prix	Brochable					Colis.	Prix
							France	Euro 1	Euro 2	Euro 3	Euro 4		
Cadenas CLUB 2 • 30 mm à combinaison modifiable	-	-	-	00971023	10	-	00171023	00193295 NS	00192295 NS	00194295	-	10	-

Mousqueton / STREET VOYAGE



NIVEAU DE SÉCURITÉ



GARANTIE



Alliage moulé

Combinaison modifiable

Description/Description/Descripción
Corps alliage moulé. Anse Ø 7 mm. Mécanisme à 3 viroles. Combinaison modifiable.

Moulded alloy body. Shackle Ø 7 mm. 3 dial mechanism. Resettable combination.
Cuerpo de aleación moldeada. Arco Ø 7 mm. Mecanismo con 3 virolas. Combinación modificable.

Finition/Finish/Acabado

Bicolore

Bicolor

Bicolor

Utilisation/Use/Utilización

Bagage

Luggage

Casilleros



CODE MODIFIABLE

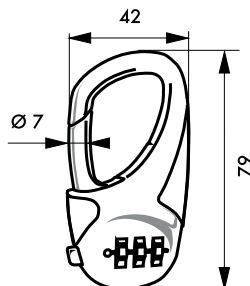

Designation	Boîte	Colis.	Prix	Sachet	Colis.	Prix	Brochable					Colis.	Prix
							France	Euro 1	Euro 2	Euro 3	Euro 4		
Mousqueton STREET à combinaison	-	-	-	-	-	-	00171017	00193287 NS	00192287 NS	00194287	-	10	-

NS Non stocké/Non-stored/Producto no estocado - □ Sur stock Europe Zone 1 et Zone 2, nous consulter pour délai d'approvisionnement - E Epuisement/Stock depletion/Agotamiento del stock

Cadenas de sûreté / LUXE VOYAGE



00063204

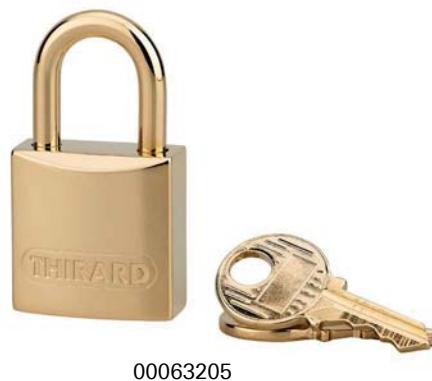

00063205



00063206

Description/Description/Descripción

Corps laiton monobloc. Anse laiton. Mécanisme à goupilles. 2 clés laiton

Compact brass body. Brass shackle. Pin mechanism. 2 brass keys.

Cuerpo de latón monobloque. Arco de latón. Mecanismo de pasadores. 2 llaves de latón.

Finition/Finish/Acabado

Laiton poli - Or - Paladium

Polished brass - Gold - Paladium

Latón pulido - Oro - Paladio

Utilisation/Use/Utilización

Bagage

Luggage

Equipaje

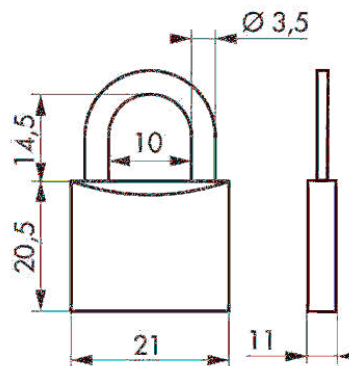

Designation	Boite	Colis.	Prix	Sachet	Colis.	Prix	Brochable					Colis.	Prix
							France	Euro 1	Euro 2	Euro 3	Euro 4		
Cadenas luxe 20 mm - laiton poli	00063204	10	-	-	-	-	-	-	-	-	-	-	-
Cadenas luxe 20 mm - or	00063205	10	-	-	-	-	-	-	-	-	-	-	-
Cadenas luxe 20 mm - paladium	00063206	10	-	-	-	-	-	-	-	-	-	-	-

⚠ Non stocké/Non-stored/Producto no estocado - 📦 Sur stock Europe Zone 1 et Zone 2, nous consulter pour délai d'approvisionnement - 📦 Epuisement/Stock depletion/Agotamiento del stock

Cadenas de sûreté / RB VOYAGE



NIVEAU DE SÉCURITÉ



GARANTIE



CODE
MODIFIABLE



Acier nickelé

Laiton

Combinaison
modifiable

Description/Description/Descripción

Corps laiton monobloc. Anse acier nickelé. Mécanisme 3 à viroles. Combinaison modifiable.

Compact brass body. Nickel plated steel shackle. 3 Dial mechanism. Resettable combination.

Cuerpo de latón monobloque. Arco de acero niquelado. Mecanismo con 3 virolas. Combinación modificable.

Finition/Finish/Acabado

Laiton poli

Polished brass

Latón pulido

Utilisation/Use/Utilización

Bagage

Luggage

Equipaje

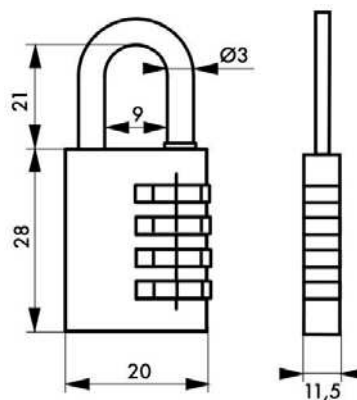

Designation	Boîte	Colis.	Prix	Sachet	Colis.	Prix	Brochable					Colis.	Prix
							France	Euro 1	Euro 2	Euro 3	Euro 4		
Cadenas RB 20 mm combinaison modifiable	-	-	-	00913945	10	-	00113945	00193712 NS	00192712 NS	00194712	-	10	-

NS Non stocké/Non-stored/Producto no estocado - Sur stock Europe Zone 1 et Zone 2, nous consulter pour délai d'approvisionnement - E Epuisement/Stock depletion/Agotamiento del stock

Cadenas de sûreté / TSA

VOYAGE



NIVEAU DE SÉCURITÉ



GARANTIE



Acier nickelé

Alliage moulé

Combinaison modifiable



Cadenas agréés par l'administration des transports internationaux. Ouverture possible par les douaniers avec une clé spéciale sans détérioration du bagage.

Description/Description/Descripción
Corps alliage moulé. Anse acier nickelé. Mécanisme à viroles. Combinaison modifiable.

Moulded alloy body. Nickel plated steel shackle. Dial mechanism. Resettable combination.

Cuerpo de aleación moldeada. Arco de acero niquelado. Mecanismo con virolas. Combinación modificable.

Finition/Finish/Acabado

Couleurs assorties

Assorted colors

Colores surtidos

Version/Option/Versión

A câble acier. Ø 3 mm long. 125 mm.

Steel cable Ø 3 mm length 125 mm

Cable de acero Ø 3 mm longitud 125 mm

Utilisation/Use/Utilización

Bagage

Luggage

Equipaje



CODE MODIFIABLE

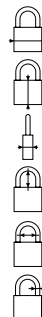

	171020	171021	171022
	30	30	30
	38	45	42
	13	12	12
	22	23	64
	11,5	11,5	11,5
	3,5	3,5	3

Designation	Boite	Colis.	Prix	Sachet	Colis.	Prix	Brochable					Colis.	Prix
							France	Euro 1	Euro 2	Euro 3	Euro 4		
Cadenas TSA à 3 viroles	-	-	-	-	-	-	00171020	00193283 NS	00192283 NS	00194283	-	10	-
Cadenas TSA à 4 viroles	-	-	-	00971021	10	-	00171021	00193284 NS	00192284 NS	00194284	-	10	-
Cadenas TSA câble à 3 viroles	-	-	-	-	-	-	00171022	00193285 NS	00192285 NS	00194285	-	10	-
Jeu de 2 cadenas TSA à 3 viroles	-	-	-	-	-	-	00171028	00193289 NS	00192289 NS	00194289	-	10	-

NS Non stocké/Non-stored/Producto no estocado - S Sur stock Europe Zone 1 et Zone 2, nous consulter pour délai d'approvisionnement - E Epuisement/Stock depletion/Agotamiento del stock

Cadenas de sûreté / TYPE 1 ALU

PROTECT



NIVEAU DE SÉCURITÉ



GARANTIE



X 2



Acier nickelé

Aluminium



Description/Description/Descripción

Corps aluminium. Anse acier cémenté nickelé. Mécanisme à goupilles. Double ancrage. 2 clés laiton nickelé.

Aluminium body. Hardened nickel plated steel shackle. Pin mechanism. Double locking. 2 nickel plated brass keys.

Cuerpo de aluminio. Arco de acero cementado níquelado. Mecanismo de pasadores. 2 llaves de latón níquelado.

Finition/Finish/Acabado

Aluminium

Aluminium

Aluminio

Version/Option/Versión

Avec coque PVC

With PVC shell

Revestimiento de PVC

Utilisation/Use/Utilización

Intérieur

Indoor

Interior

Designation	Boite	Colis.	Prix	Sachet	Colis.	Prix	Brochable					Colis.	Prix
							France	Euro 1	Euro 2	Euro 3	Euro 4		
Cadenas TYPE 1 ALU 30 mm	00024130	10	-	00924130	10	-	00124130	00193301 NS	00192301 NS	00194311	-	10	-
Cadenas TYPE 1 ALU COLOR 30 mm couleurs assorties	-	-	-	-	-	-	00124230	00193304 NS	00192304 NS	00194304	-	10	-
Cadenas TYPE 1 ALU COLOR 30 mm rose	00024231	10	-	-	-	-	-	-	-	-	-	-	-
Cadenas TYPE 1 ALU COLOR 30 mm bleu	00024232	10	-	-	-	-	-	-	-	-	-	-	-
Cadenas TYPE 1 ALU COLOR 30 mm orange	00024233	10	-	-	-	-	-	-	-	-	-	-	-
Cadenas TYPE 1 ALU COLOR 30 mm vert	00024234	10	-	-	-	-	-	-	-	-	-	-	-
Cadenas TYPE 1 ALU COLOR 30 mm noir	00024235	10	-	-	-	-	-	-	-	-	-	-	-
Jeu de 2 Cadenas TYPE 1 ALU COLOR 30 mm noir s'ouvrant 4 clés	-	-	-	-	-	-	-	-	-	00194062	-	10	-
Cadenas TYPE 1 ALU 40 mm	00024140	10	-	-	-	-	00124140	00193302 NS	00192302 NS	00194302	-	10	-
Cadenas TYPE 1 ALU COLOR 40 mm couleurs assorties	-	-	-	-	-	-	00124240	00193305 NS	00192305 NS	00194305	-	10	-
Cadenas TYPE 1 ALU 40 mm anse 1/2 haute	00024141	10	-	-	-	-	00124141	00193701 NS	00192701 NS	00194701	-	10	-
Cadenas TYPE 1 ALU COLOR 40 mm anse 1/2 haute coul. assorties	-	-	-	-	-	-	00124241	00193702 NS	00192702 NS	00194702	-	10	-
Cadenas TYPE 1 ALU COLOR 40 mm rose	00024241	10	-	-	-	-	-	-	-	-	-	-	-
Cadenas TYPE 1 ALU COLOR 40 mm bleu	00024242	10	-	-	-	-	-	-	-	-	-	-	-

NS Non stocké/Non-stored/Producto no estocado - Sur stock Europe Zone 1 et Zone 2, nous consulter pour délai d'approvisionnement - E Epuisement/Stock depletion/Agotamiento del stock

Cadenas de sûreté / TYPE 1 ALU

PROTECT

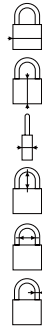

				ANSE 1/2 HAUTE
30mm	40mm	50mm	60mm	40mm
30	40	50	60	40
27	32	37	43	33
13	13,5	18	19	17
19	29	24	34,5	63
14,5	21	25	34,8	21
5	6,5	7	9,5	6

Designation	Boite	Colis.	Prix	Sachet	Colis.	Prix	Brochable					Colis.	Prix
							France	Euro 1	Euro 2	Euro 3	Euro 4		
Cadenas TYPE 1 ALU COLOR 40 mm orange	00024243	10	-	-	-	-	-	-	-	-	-	-	-
Cadenas TYPE 1 ALU COLOR 40 mm vert	00024244	10	-	-	-	-	-	-	-	-	-	-	-
Cadenas TYPE 1 ALU COLOR 40 mm noir	00024245	10	-	-	-	-	-	-	-	-	-	-	-
Cadenas TYPE 1 ALU COLOR 50 mm rose	00024251	10	-	-	-	-	-	-	-	-	-	-	-
Cadenas TYPE 1 ALU COLOR 50 mm bleu	00024253	10	-	-	-	-	-	-	-	-	-	-	-
Cadenas TYPE 1 ALU COLOR 50 mm orange	00024254	10	-	-	-	-	-	-	-	-	-	-	-
Cadenas TYPE 1 ALU COLOR 50 mm vert	00024255	10	-	-	-	-	-	-	-	-	-	-	-
Cadenas TYPE 1 ALU COLOR 50 mm noir	00024256	10	-	-	-	-	-	-	-	-	-	-	-
Cadenas TYPE 1 ALU COLOR 40 mm anse 1/2 haute rose	00024341	10	-	-	-	-	-	-	-	-	-	-	-
Cadenas TYPE 1 ALU COLOR 40 mm anse 1/2 haute bleu	00024342	10	-	-	-	-	-	-	-	-	-	-	-
Cadenas TYPE 1 ALU COLOR 40 mm anse 1/2 haute orange	00024343	10	-	-	-	-	-	-	-	-	-	-	-
Cadenas TYPE 1 ALU COLOR 40 mm anse 1/2 haute vert	00024344	10	-	-	-	-	-	-	-	-	-	-	-
Cadenas TYPE 1 ALU COLOR 40 mm anse 1/2 haute noir	00024345	10	-	-	-	-	-	-	-	-	-	-	-
Cadenas TYPE 1 ALU COLOR 50 mm couleurs assorties	-	-	-	-	-	-	00124250	00193703 NS	00192703 NS	00194703	-	10	-
Jeu de 4 cadenas TYPE 1 ALU COLOR 40 mm noir s'ouvrant 8 clés	-	-	-	-	-	-	-	-	-	00294003	-	10	-
Cadenas TYPE 1 ALU 50 mm	00028150	10	-	-	-	-	00128150	00193840 NS	00192840 NS	00194840	-	10	-
Cadenas TYPE 1 ALU 60 mm	00028160	10	-	-	-	-	00228160	00293840 NS	00292840 NS	00294840	-	10	-

NS Non stocké/Non-stored/Producto no estocado - ☐ Sur stock Europe Zone 1 et Zone 2, nous consulter pour délai d'approvisionnement - ☒ Epuisement/Stock depletion/Agotamiento del stock

Cadenas de sûreté / TYPE 1

PROTECT



NIVEAU DE SÉCURITÉ



GARANTIE



X 2



Description/Description/Descripción

Corps alliage monobloc. Anse acier cémenté nickelé. Mécanisme à goupilles. Simple ancrage. 2 clés acier nickelé.

Compact alloy body. Hardened nickel plated steel shackle. Pin mechanism. Single locking. 2 nickel plated steel keys.

Cuerpo de aleación monobloque. Arco de acero cementado niquelado. Mecanismo de pasadores. Simple anclaje. 2 llaves de acero niquelado. Acabado Latón pulido.

Finition/Finish/Acabado

Bronze / Bronze / Bronce

Version/Option/Versión

Anse demi-haute pour taille 40-50-60mm. Sans fabrication sur numéro imposé.

Demi long shackle for size 40-50-60mm. Without manufacturing under request number

Arco semialto para tamaño 40-50-60mm. Sin fabricación con número impuesto

Utilisation/Use/Utilización

Intérieur / Indoor / Interior



Acier nickelé

Alliage

Designation	Boite	Colis.	Prix	Sachet	Colis.	Prix	Brochable					Colis.	Prix
							France	Euro 1	Euro 2	Euro 3	Euro 4		
TYPE 1 • 30 mm	-	-	-	00980030	20	-	00180030	00193003 NS	00192003 NS	00194003	-	10	-
TYPE 1 • 35 mm	-	-	-	00980035	20	-	00180035	00193006 NS	00192006 NS	00194006	-	10	-
TYPE 1 • 40 mm	-	-	-	00980040	20	-	00180040	00193008 NS	00192008 NS	00194008	-	10	-
TYPE 1 • 40 mm anse 1/2 haute 61 mm	-	-	-	00980640	20	-	00180640	00193009 NS	00192009 NS	00194009	-	10	-
TYPE 1 • 45 mm	-	-	-	00980045	20	-	00180045	00193012 NS	00192012 NS	00194012	-	10	-
TYPE 1 • 50 mm	-	-	-	00980050	10	-	00180050	00193015 NS	00192015 NS	00194015	-	10	-
TYPE 1 • 50 mm anse 1/2 haute 72mm	-	-	-	00980650	10	-	00180650	-	-	-	-	10	-
Jeu de 2 cadenas TYPE 1 • 30 mm s'ouvrant 4 clés	-	-	-	00980230	20	-	00180230	00193004 NS	00192004 NS	00194004	-	10	-
Jeu de 3 cadenas TYPE 1 • 30 mm s'ouvrant 6 clés	-	-	-	00980033	5	-	00280030	00293005 NS	00292005 NS	00294005	-	5	-
Jeu de 2 cadenas TYPE 1 • 35 mm s'ouvrant 4 clés	-	-	-	-	-	-	00180034	-	-	-	-	10	-

NS Non stocké/Non-stored/Producto no estocado - S Sur stock Europe Zone 1 et Zone 2, nous consulter pour délai d'approvisionnement - E Epuisement/Stock depletion/Agotamiento del stock

Cadenas de sûreté / TYPE 1

PROTECT



NIVEAU DE SÉCURITÉ



GARANTIE

								ANSE DEMI HAUTE		
	30mm	35mm	40mm	45mm	50mm	60 mm	75 mm	40mm	50mm	60mm
	30	35	40	45	50	60	75	40	50	60
	28	28	32	35	40	49	57,5	33	40	49
	15	13	16	15	21	23	24	16	20	22
	17	21	23	26	28	36	41	55	64	70
	16	20	21	26	25	33	41	20	26	32
	5	4,5	6	6	8	9	9,5	6	8	8,5
Goup.	3	3	3	3	4	4	5	3	4	4

Designation	Boite	Colis.	Prix	Sachet	Colis.	Prix	Brochable					Colis.	Prix
							France	Euro 1	Euro 2	Euro 3	Euro 4		
Jeu de 3 cadenas TYPE 1 • 35 mm s'ouvrant 6 clés	-	-	-	00980037	5	-	00280035	00293007 NS	00292007 NS	00294007	-	5	-
Jeu de 2 cadenas TYPE 1 • 40 mm s'ouvrant 4 clés	-	-	-	00980044	10	-	00180044	00193011 NS	00192011 NS	00194011	00195011 NS	10	-
Jeu de 3 cadenas TYPE 1 • 40 mm s'ouvrant 6 clés	-	-	-	00980340	5	-	00280340	-	-	-	-	5	-
Jeu de 2 cadenas TYPE 1 • 45 mm s'ouvrant 4 clés	-	-	-	-	-	-	00180245	00193014 NS	00192014 NS	00194014	-	10	-
Jeu de 3 cadenas TYPE 1 • 45 mm s'ouvrant 6 clés	-	-	-	-	-	-	00280045	-	-	-	-	5	-
TYPE 1 • 60 mm	-	-	-	00980060	10	-	00280060	00293016 NS	00292016 NS	00294016	00295016 NS	10	-
TYPE 1 • 60 mm anse 1/2 haute 79 mm	-	-	-	-	-	-	00289060	00293017 NS	00292017 NS	00294017	-	10	-
TYPE 1 • 75 mm	-	-	-	00980070	10	-	00280070	00293018 NS	00292018 NS	00294018	-	10	-

NS Non stocké/Non-stored/Producto no estocado - ☐ Sur stock Europe Zone 1 et Zone 2, nous consulter pour délai d'approvisionnement - ☒ Epuisement/Stock depletion/Agotamiento del stock

Cadenas de sûreté / TYPE 1

PROTECT



NIVEAU DE SÉCURITÉ



GARANTIE



X 2

	mm							ANSE HAUTE
	35mm	40mm	45mm	50mm	60mm	70mm	40mm	
	30	35	40	45	50	60	70	40
	27	30	33	38	42	50,4	54	40
	14	14,5	14,5	15,5	17	18,5	21	14,5
	18	20	22	24	26	32	40	130
	15	19	21	25	25	31	39	40
	5,5	5,5	6	7	9	10	11	6
Goup.	4	4	5	5	5	5	5	5

Description/Description/Descripción

Corps laiton monobloc. Anse laiton. Mécanisme à goupilles. Double ancrage. 2 clés acier nickelé. *Compact brass body. Brass shackle. Pin mechanism. Double locking. 2 nickel plated steel keys.*

Cuerpo de latón monobloque. Arco de latón. Mecanismo de pasadores. Doble anclaje. 2 llaves de acero niquelado. Acabado Latón pulido.

Finition/Finish/Acabado

Laiton poli
Polished brass
Latón pulido

Versión/Option/Versión

Anse haute pour taille 40 mm. Clés supplémentaires sur

modèle. Sans fabrication sur numéro imposé. Cadenas sur même combinaison pour taille 30, 35, 40, 45, 50 mm. *Long shackle for size 40 mm. Extra keys with model. Without manufacturing under request number. Keyed alike padlocks for size 30, 35, 40, 45, 50 mm available.*

Arco alto para tamaño 40 mm. Llaves suplementarias sobre modelo. Sin fabricación con número impuesto. Candado con la misma combinación para tamaños 30, 35, 40, 45, 50 mm.

Utilisation/Use/Utilización

Extérieur, anti-corrosion
Outdoor, Weather proof
Exterior, Anticorrosión

Designation	Boite	Colis.	Prix	Sachet	Colis.	Prix	Brochable					Colis.	Prix
							France	Euro 1	Euro 2	Euro 3	Euro 4		
TYPE 1 • 30 mm	00080031	10	-	-	-	-	00180031	00193021 <small>NS</small>	00192021 <small>NS</small>	00194021	-	10	-
TYPE 1 • 35 mm	00080036	10	-	-	-	-	00180036	00193022 <small>NS</small>	00192022 <small>NS</small>	00194022	-	10	-
TYPE 1 • 40 mm	00080041	10	-	-	-	-	00180041	00193023 <small>NS</small>	00192023 <small>NS</small>	00194023	-	10	-
TYPE 1 • 40 mm anse haute	00080043	10	-	-	-	-	00280043	00293024 <small>NS</small>	00292024 <small>NS</small>	00294024	-	10	-
TYPE 1 • 45 mm	00080046	10	-	-	-	-	00180046	00193025 <small>NS</small>	00192025 <small>NS</small>	00194025	-	10	-
TYPE 1 • 50 mm	00080051	10	-	-	-	-	00180051	00193026 <small>NS</small>	00192026 <small>NS</small>	00194026	-	10	-
TYPE 1 • 60 mm	00080061	10	-	-	-	-	00280061	00293027 <small>NS</small>	00292027 <small>NS</small>	00294027	-	10	-
TYPE 1 • 70 mm	00080071	10	-	-	-	-	00280071	-	-	-	-	10	-

NS Non stocké/Non-stored/Producto no estocado - ■ Sur stock Europe Zone 1 et Zone 2, nous consulter pour délai d'approvisionnement - E Epuisement/Stock depletion/Agotamiento del stock

Cadenas de sûreté / ANSE REGLABLE PROTECT



NIVEAU DE SÉCURITÉ



GARANTIE



X 2



Acier nickelé

Laiton

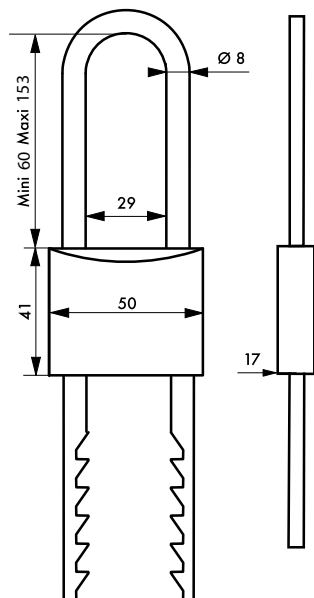

Description/Description/Descripción

Corps laiton. Anse acier cémenté nickelé réglable. Mécanisme à goupilles. Double verrouillage. 2 clés acier.

Brass body. Adjustable hardened nickel-plated steel shackle. Pins mechanism. Double locking. 2 steel keys.

Cuerpo de latón. Arco de acero cementado níquelado ajustable. Mecanismo de pasadores. Doble bloqueo. 2 llaves de acero.

Finition/Finish/Acabado

Laiton poli

Polished brass

Latón pulido

Utilisation/Use/Utilización

Intérieur

Indoor

Interior

Designation	Boite	Colis.	Prix	Sachet	Colis.	Prix	Brochable					Colis.	Prix
							France	Euro 1	Euro 2	Euro 3	Euro 4		
Cadenas 50 mm anse réglable	00002051	10	-	00902051	10	-	00202051	00293825 NSI	00292825 NSI	00294825	-	10	-

NS Non stocké/Non-stored/Producto no estocado - S Sur stock Europe Zone 1 et Zone 2, nous consulter pour délai d'approvisionnement - E Epuisement/Stock depletion/Agotamiento del stock

Cadenas de sûreté / THIRARD COLOR

PROTECT



NIVEAU DE SÛRETÉ



GARANTIE



Acier nickelé

Laiton gainé
PVC



Description/Description/Descripción

Corps laiton monobloc gainé PVC. Anse acier cémenté nickelé. Mécanisme à goupilles. Double ancrage. 2 clés acier nickelé gainé PVC.

Compact brass body protected by a PVC shell. Hardened nickel plated shackle. Pin mechanism - Double locking. 2 nickel plated steel keys with head protected by a PVC shell. Cuerpo de latón monobloque con revestimiento de PVC. Arco de acero cementado niquelado. Mecanismo de pasadores - Doble anclaje. 2 llaves de acero niquelado con revestimiento de PVC.

Finition/Finish/Acabado

PVC vert, rose, bleu, noir et jaune.

Green, pink, blue, black and yellow color PVC. PVC verde, rosa, azul, negro y amarillo.

Version/Option/Versión

Simple ancrage pour taille 30mm. Clés supplémentaires sur modèle. Sans fabrication sur numéro imposé. Cadenas sur même combinaison pour taille 40 mm.

Simple locking 30 mm. Extra keys with model. Without manufacturing under request number. Keyed alike padlocks for size 40 mm available.

Simple anclaje 30 mm. Arco de latón. Llaves suplementarias sobre modelo. Sin fabricación con número impuesto. Candado con la misma combinación para el tamaño 40 mm.

Utilisation/Use/Utilización

Intérieur

Indoor

Interior

	30 mm	40 mm
	32	42
	27	33
	14	14,5
	18	22
	15	20
	5,5	6
Goup.	4	5

5 coloris différents avec anse acier ou laiton. Le Thirard color est anti choc avec sa gaine PVC.

Designation	Boite	Colis.	Prix	Sachet	Colis.	Prix	Brochable					Colis.	Prix
							France	Euro 1	Euro 2	Euro 3	Euro 4		
THIRARD COLOR 30 mm couleurs assorties	00098130	10	-	-	-	-	00198130	00193034 NS	00192034 NS	00194034	-	10	-
THIRARD COLOR 40 mm couleurs assorties	00098100	10	-	00998100	10	-	00198100	00193035 NS	00192035 NS	00194035	-	10	-
THIRARD COLOR vert 40 mm	00098101	10	-	-	-	-	00198101	-	00192390 NS	-	-	10	-
THIRARD COLOR rose 40 mm	00098102	10	-	-	-	-	00198102	-	00192391 NS	-	-	10	-
THIRARD COLOR bleu 40 mm	00098103	10	-	-	-	-	00198103	-	00192392 NS	-	-	10	-
THIRARD COLOR noir 40 mm	00098104	10	-	-	-	-	00198104	-	-	-	-	10	-
THIRARD COLOR jaune 40 mm	00098105	10	-	-	-	-	00198105	-	-	-	-	10	-
Jeu de 3 cadenas THIRARD COLOR 30 mm s'ouvrant 6 clés	-	-	-	-	-	-	00298130	00293037 NS	00292037 NS	00294037	-	10	-

NS Non stocké/Non-stored/Producto no estocado - S Sur stock Europe Zone 1 et Zone 2, nous consulter pour délai d'approvisionnement - E Epuisement/Stock depletion/Agotamiento del stock

Cadenas de sûreté / THIRARD COLOR

PROTECT



NIVEAU DE SÉCURITÉ



GARANTIE



X 2



Laiton

Laiton gainé
PVC

Description/Description/Descripción

Corps laiton monobloc gainé PVC. Anse laiton. Mécanisme à goupilles. Double ancrage. 2 clés acier nikelé gainé PVC. *Compact brass body protected by a PVC shell. Brass shackle. Pin mechanism - Double locking. 2 nickel plated steel keys with head protected by a PVC shell.*

Cuerpo de latón monobloque con revestimiento de PVC. Arco de latón. Mecanismo de pasadores - Doble anclaje. 2 llaves de acero niquelado con revestimiento de PVC

Finition/Finish/Acabado

PVC vert, rose, bleu, noir et jaune

Green, pink, blue, black and yellow color PVC

PVC verde, rosa, azul, negro y amarillo

Version/Option/Versión

Clés supplémentaires sur modèle. Sans fabrication sur numéro imposé. Cadenas sur même combinaison. pour taille 40 mm.

Extra keys with model. Without manufacturing under request number. Keyed alike padlocks for size 40 mm available.

Llaves suplementarias sobre modelo. Sin fabricación con número impuesto. Candado con la misma combinación para el tamaño 40 mm.

Utilisation/Use/Utilización

Extérieur

Outdoor

Exterior

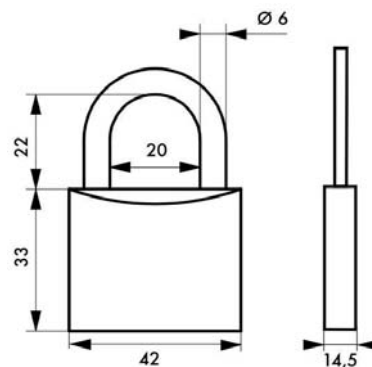

Designation	Boite	Colis.	Prix	Sachet	Colis.	Prix	Brochable					Colis.	Prix
							France	Euro 1	Euro 2	Euro 3	Euro 4		
THIRARD COLOR 40 mm anse laiton couleurs assorties	00099100	10	-	-	-	-	00199100	-	00192036 NS	00194036	-	10	-

NS Non stocké/Non-stored/Producto no estocado - ☐ Sur stock Europe Zone 1 et Zone 2, nous consulter pour délai d'approvisionnement - E Epuisement/Stock depletion/Agotamiento del stock

Cadenas de sûreté / RUBY

PROTECT



NIVEAU DE SÉCURITÉ



GARANTIE



X 3



Acier nickelé

Acier laitonné



Description/Description/Descripción

Corps acier laitonné. Anse acier cémenté nickelé. Mécanisme à goupilles. Simple verrouillage. 3 clés acier.

Brass-plated steel body. Case-hardened nickel-plated steel shackle. Pins mechanism. Simple locking. 3 steel keys.

Cuerpo de acero latonado. Arco de acero cementado níquelado. Mecanismo de pasadores. Bloqueo simple. 3 llaves de acero.

Finition/Finish/Acabado

Acier laitonné
Brass-plated steel
Acero latonado

Versión/Option/Versión

Simple verrouillage pour taille 32 mm
Simple locking for size 32 mm
Bloqueo simple para tamaño 32 mm

Utilisation/Use/Utilización

Intérieur
Indoor
Interior

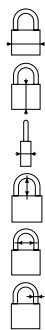

Goup.

	32 mm	38 mm	50 mm
	32	38	50
	30	35	42
	15	17	21,5
	19	19,5	27
	16	19,5	27
	5	6	8
	4	5	5

Designation	Boite	Colis.	Prix	Sachet	Colis.	Prix	Brochable					Colis.	Prix
							France	Euro 1	Euro 2	Euro 3	Euro 4		
Cadenas RUBY 32 mm	-	-	-	00986030	10	-	00186030	00193826 NS	00192826 NS	00194826	-	10	-
Cadenas RUBY 38 mm	-	-	-	00986040	10	-	00186040	00193827 NS	00192827 NS	00194827	-	10	-
Cadenas RUBY 50 mm	-	-	-	00986050	10	-	00186050	00193828 NS	00192828 NS	00194828	-	10	-

NS Non stocké/Non-stored/Producto no estocado - Sur stock Europe Zone 1 et Zone 2, nous consulter pour délai d'approvisionnement - E Epuisement/Stock depletion/Agotamiento del stock

Cadenas de sûreté / RUBY COLOR PROTECT



NIVEAU DE SÉCURITÉ



GARANTIE



X 3



Acier nickelé

Acier
gainé PVC

Description/Description/Descripción

Corps acier gainé PVC. Anse acier cémenté nickelé.
Mécanisme à disques. Simple verrouillage. 3 clés acier nickelé.

PVC coated steel body. Case-hardened nickel-plated steel shackle. Discs mechanism. Simple locking. 3 nickel-plated steel keys

Cuerpo de acero con funda PVC. Arco de acero cementado niquelado. Mecanismo de discos. Bloqueo simple. 3 llaves de acero niquelado.

Finition/Finish/Acabado

PVC couleurs assorties

PVC Assorted colors

PVC colores surtidos

Utilisation/Use/Utilización

Intérieur

Indoor

Interior

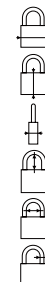

Disq.

	32 mm	38 mm	50 mm
	34,5	43	52,5
	27	33	40
	18,5	20	22
	19,5	21	27,5
	16	19,5	26,5
	5	6	8
Disq.	4	5	5

Designation	Boite	Colis.	Prix	Sachet	Colis.	Prix	Brochable					Colis.	Prix
							France	Euro 1	Euro 2	Euro 3	Euro 4		
Cadenas RUBY Color 32 mm	-	-	-	00986130	10	-	00186130	00193817 NS	00192817 NS	00194817	-	10	-
Cadenas RUBY Color 38 mm	-	-	-	00986140	10	-	00186140	00193818 NS	00192818 NS	00194818	-	10	-
Cadenas RUBY Color 50 mm	-	-	-	00986150	10	-	00186150	00193819 NS	00192819 NS	00194819	-	10	-

NS Non stocké/Non-stored/Producto no estocado - Sur stock Europe Zone 1 et Zone 2, nous consulter pour délai d'approvisionnement - Epuisement/Stock depletion/Agotamiento del stock

Cadenas de sûreté / COLORFUL PROTECT



NIVEAU DE SÉCURITÉ



GARANTIE



Acier nickelé

Aluminium



Description/Description/Descripción

Corps aluminium nickelé. Anse acier cémenté nickelé. Double verrouillage par billes. Verrouillage par la clé. Mécanisme à disques. 3 clés.

Nickel-plated aluminium body. Hardened nickel-plated steel shackle. Double locking with beads. Locked with a key. Discs mechanism. 3 keys.

Cuerpo de aluminio niquelado. Arco de acero cementado niquelado. Doble bloqueo con bolas. Bloqueo con llave. Mecanismo de discos. 3 llaves.

Finition/Finish/Acabado

Couleurs assorties

Assorted colors

Colores surtidos

Utilisation/Use/Utilización

Intérieur

Indoor

Interior



X 3

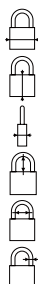

Disq.

	40 mm	50 mm	60mm
	40	50	60
	32	38	43
	20	20	21
	21	27	32
	20	23	27
	7	9,5	10,5
Disq.	4	5	5

Designation	Boite	Colis.	Prix	Sachet	Colis.	Prix	Brochable					Colis.	Prix
							France	Euro 1	Euro 2	Euro 3	Euro 4		
Cadenas Colorful 40 mm	-	-	-	00928114	10	-	00128114	00193833 	00192833 	00194833	-	10	-
Cadenas Colorful 50 mm	-	-	-	00928115	10	-	00128115	00193834 	00192834 	00194834	-	10	-
Cadenas Colorful 60 mm	-	-	-	00928116	10	-	00228116	00293835 	00292835 	00294835	-	10	-

Non stocké/Non-stored/Producto no estocado - Sur stock Europe Zone 1 et Zone 2, nous consulter pour délai d'approvisionnement - Epuisement/Stock depletion/Agotamiento del stock

Cadenas de sûreté / ASTRA PROTECT

Avec son anse intégrée ce cadenas est idéalement conçu pour les chaînes.



NIVEAU DE SÉCURITÉ



GARANTIE

Description/Description/Descripción

Corps inox. Anse acier cémenté. Mécanisme à goupilles. 2 clés laiton nickelé. *Stainless steel case. Hardened steel shackle. Pin mechanism. 2 nickel plated brass keys.* Cuerpo de acero inoxidable. Arco de acero cementado. Mecanismo de pasadores. 2 llaves de latón niquelada.

Finition/Finish/Acabado

Inox poli / *Polished stainless steel*

Polished stainless steel

Versión/Option/Versión

Clés supplémentaires sur modèle. Sans fabrication sur numéro imposé. Cadenas sur même combinaison.

Extra keys with requested model. Without supplying under requested number. Keyed alike padlocks available.

Arco de acero inoxidable. Llaves suplementarias sobre modelo sin fabricación con número impuesto.

Utilisation/Use/Utilización

Intérieur / *Indoor* / Interior



X 2

Designation	Boite	Colis.	Prix	Sachet	Colis.	Prix	Brochable					Colis.	Prix
							France	Euro 1	Euro 2	Euro 3	Euro 4		
Cadenas ASTRA 70 mm anse acier cémenté	00092700	10	-	00992700	10	-	00192700	00193040 NS	00192040 NS	00194040	-	10	-
Cadenas ASTRA 80 mm anse acier cémenté	00098700	10	-	-	-	-	00298700	00293004 NS	00292004 NS	00294004	-	10	-

Cadenas de sûreté / 2493 PROTECT

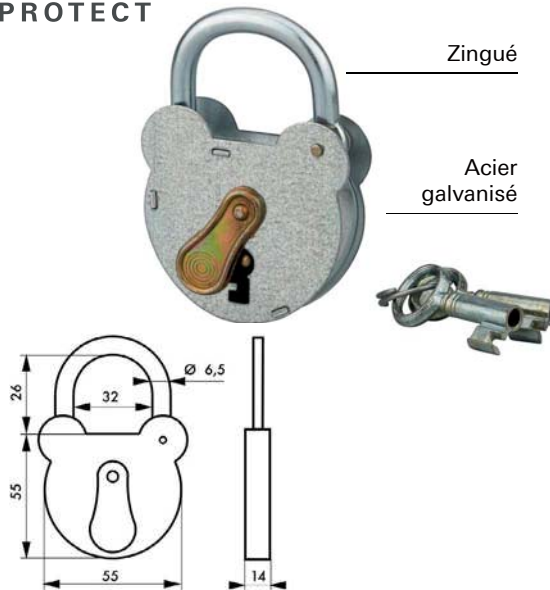

NIVEAU DE SÉCURITÉ



GARANTIE

Description/Description/Descripción

Corps acier galvanisé. avec cache entrée. Anse zinguée. Mécanisme à gorge. 2 clés. *Galvanized steel case. with drop. Zinc coated shackle. Lever mechanism. 2 keys.* Cuerpo de acero galvanizado. con escudo de bloqueo. Arco cincado. Mecanismo de canalillo. 2 llaves.

Finition/Finish/Acabado

Galvanisé / *Galvanized* / Galvanizado

Utilisation/Use/Utilización

Extérieur / *Outdoor* / Exterior



X 2

Designation	Boite	Colis.	Prix	Sachet	Colis.	Prix	Brochable					Colis.	Prix
							France	Euro 1	Euro 2	Euro 3	Euro 4		
Cadenas 2493 • 55 mm	-	-	-	00993155	20	-	00193155	00193393 NS	00192393	-	-	10	-

NS Non stocké/Non-stored/Producto no estocado - ☐ Sur stock Europe Zone 1 et Zone 2, nous consulter pour délai d'approvisionnement - ☒ Epuisement/Stock depletion/Agotamiento del stock

Cadenas de sûreté / CODE ALU

PROTECT



NIVEAU DE SÉCURITÉ



GARANTIE



CODE MODIFIABLE



Acier nickelé

Aluminium

Combinaison modifiable

Description/Description/Descripción

Corps aluminium. Anse acier nickelé.
Mécanisme à viroles. Combinaison modifiable.

*Aluminium body. Nickel plated steel shackle.
Dial mechanism. Resettable combination.*

Cuerpo de aluminio. Arco de acero niquelado.
Mecanismo con virolas.
Combinación modificable.

Finition/Finish/Acabado

Aluminium / Aluminium / Aluminio

Utilisation/Use/Utilización

Intérieur / Indoor / Interior

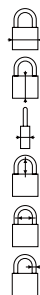

	30 mm	40 mm
	30	40
	35	44
	12,5	13
	26	22
	14	25
	5	6

Designation	Boite	Colis.	Prix	Sachet	Colis.	Prix	Brochable					Colis.	Prix
							France	Euro 1	Euro 2	Euro 3	Euro 4		
Cadenas TYPE 1 ALU CODE 30 mm couleurs assorties	-	-	-	00912030	10	-	00112030	00193306 NS	00192306 NS	00194306	-	10	-
Cadenas TYPE 1 ALU CODE 30 mm violet	00012031	10	-	-	-	-	-	-	-	-	-	-	-
Cadenas TYPE 1 ALU CODE 30 mm bleu	00012032	10	-	-	-	-	00112032	-	-	-	-	10	-
Cadenas TYPE 1 ALU CODE 30 mm vert	00012033	10	-	-	-	-	-	-	-	-	-	-	-
Cadenas TYPE 1 ALU CODE 30 mm rouge	00012034	10	-	-	-	-	-	-	-	-	-	-	-
Cadenas TYPE 1 ALU CODE 30 mm gris	00012035	10	-	00912035	10	-	-	-	-	-	-	-	-
Cadenas TYPE 1 ALU CODE 40 mm couleurs assorties	-	-	-	00912040	10	-	00112040	00193704 NS	00192704 NS	00194704	-	10	-
Cadenas TYPE 1 ALU CODE 40 mm violet	00012041	10	-	-	-	-	00112041	-	-	-	-	10	-
Cadenas TYPE 1 ALU CODE 40 mm bleu	00012042	10	-	-	-	-	-	-	-	-	-	-	-
Cadenas TYPE 1 ALU CODE 40 mm vert	00012043	10	-	-	-	-	-	-	-	-	-	-	-
Cadenas TYPE 1 ALU CODE 40 mm rouge	00012044	10	-	-	-	-	00112044	-	-	-	-	10	-
Cadenas TYPE 1 ALU CODE 40 mm gris	00012045	10	-	-	-	-	-	-	-	-	-	-	-

NS Non stocké/Non-stored/Producto no estocado - Sur stock Europe Zone 1 et Zone 2, nous consulter pour délai d'approvisionnement - E Epuisement/Stock depletion/Agotamiento del stock

Cadenas de sûreté / COMPACT 04

PROTECT



NIVEAU DE SÉCURITÉ



GARANTIE



Acier nickelé

Alliage moulé

Combinaison modifiable

00037900

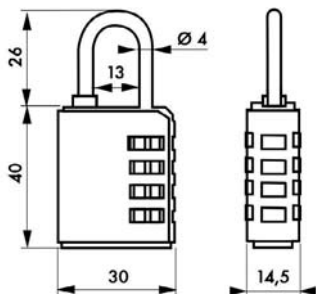

00037901



Description/Description/Descripción

Corps alliage moulé. Anse acier nickelé. Mécanisme à 4 viroles. Combinaison modifiable (10 000 combinaisons possibles).
Moulded alloy body. Nickel plated steel shackle. 4 dial mechanism. Resettable combination (10 000 combinations available).
 Cuerpo de aleación moldeada. Arco de acero niquelado. Mecanismo con 4 virolas. Combinación modificable (10 000 combinaciones posibles).

Finition/Finish/Acabado

Noir / Black / Negro

Utilisation/Use/Utilización

Intérieur / Indoor / Interior



CODE MODIFIABLE

Designation	Boite	Colis.	Prix	Sachet	Colis.	Prix	Brochable					Colis.	Prix
							France	Euro 1	Euro 2	Euro 3	Euro 4		
Cadenas COMPACT 04 • 40 mm combinaison modifiable	00037900	10	-	00937900	10	-	-	-	-	-	-	-	-
Cadenas COMPACT 40 mm combinaison modifiable ouvrant sur clé passe	00037901	10	-	-	-	-	-	-	-	-	-	-	-
Clé passe pour cadenas à combinaison 037901	00097901	10	-	-	-	-	-	-	-	-	-	-	-

Cadenas de sûreté / COLLEGE

PROTECT



NIVEAU DE SÉCURITÉ



GARANTIE



Acier nickelé

Inox

Combinaison modifiable

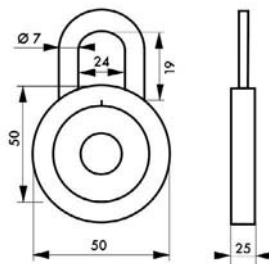

Description/Description/Descripción

Corps inox. Anse acier cémenté nickelé. Mécanisme à disques. Simple verrouillage. Combinaison fixe.
Stainless steel body. Hardened nickel plated steel shackle. Disk mechanism. Simple locking. Fixed combination.

Cuerpo de acero inoxidable. Arco de acero cementado, niquelado. Mecanismo de discos. Simple cierre. Combinación fija.

Finition/Finish/Acabado

Couleurs assorties / Assorted colors

Colores surtidos

Utilisation/Use/Utilización

Intérieur / Indoor / Interior

Designation	Boite	Colis.	Prix	Sachet	Colis.	Prix	Brochable					Colis.	Prix
							France	Euro 1	Euro 2	Euro 3	Euro 4		
Cadenas COLLEGE à bouton combinaison fixe couleurs assorties	-	-	-	00900246	10	-	00100246	00193043	-	00194043	-	10	-

Ⓝ Non stocké/Non-stored/Producto no estocado - Ⓜ Sur stock Europe Zone 1 et Zone 2, nous consulter pour délai d'approvisionnement - Ⓞ Epuisement/Stock depletion/Agotamiento del stock

Cadenas de sûreté / TANKER PROTECT



NIVEAU DE SÉCURITÉ



GARANTIE



CODE MODIFIABLE



Acier nickelé

Alliage laitonné

Combinaison modifiable

Description/Description/Descripción

Corps alliage. Anse acier chromé.
Mécanisme à 4 viroles. Combinaison modifiable. 10 000 combinaisons possibles.
Alloy body. Chrome plated steel shackle. 4 Dial mechanism. Resettable combination. 10 000 combinations available.
Cuerpo de aleación. Arco de acero cromado. Mecanismo con 4 virolas. Combinación modificable. 10.000 combinaciones posibles.

Finition/Finish/Acabado

Laitonné
Brass plated
Latonado

Utilisation/Use/Utilización

Intérieur
Indoor
Interior

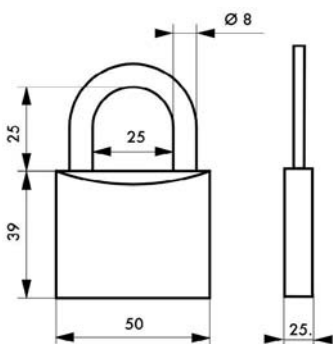

Designation	Boîte	Colis.	Prix	Sachet	Colis.	Prix	Brochable					Colis.	Prix
							France	Euro 1	Euro 2	Euro 3	Euro 4		
Cadenas TANKER à combinaison modifiable	-	-	-	-	-	-	00190803	00193242 NS	00192242 NS	00194242	-	10	-

Cadenas de sûreté / ZIPPER PROTECT



NIVEAU DE SÉCURITÉ



GARANTIE



CODE MODIFIABLE

DISPONIBLE JUSQU'À
ÉPUISEMENT DES STOCKS



Acier nickelé

Combinaison modifiable

ABS

Description/Description/Descripción

Corps ABS. Câble acier Ø 3,5 mm long. 0,55 m. Mécanisme à 3 viroles. Combinaison modifiable.

ABS shell. Steel cable Ø 3,5 mm length 0,55m. 3 dials mechanism - Resettable combination.

Cuerpo de ABS. Cable de acero Ø 3,5 mm longitud 0,55 m. Mecanismo con 3 virolas - Combinación modificable.

Finition/Finish/Acabado

Noir
Black
Negro

Utilisation/Use/Utilización

Multifonctions
Multifunction
Multifunción

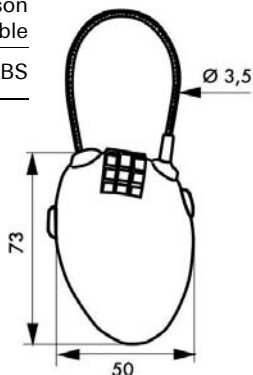

Designation	Boîte	Colis.	Prix	Sachet	Colis.	Prix	Brochable					Colis.	Prix
							France	Euro 1	Euro 2	Euro 3	Euro 4		
Câble enrouleur ZIPPER long. 0,55 m à combinaison modifiable	-	-	-	-	-	-	00171003 E	00193288 E NS	00192288 E NS	00194288 E	-	10	-

NS Non stocké/Non-stored/Producto no estocado - E Sur stock Europe Zone 1 et Zone 2, nous consulter pour délai d'approvisionnement - E Epuisement/Stock depletion/Agotamiento del stock

Cadenas à câble / ROLLER PROTECT

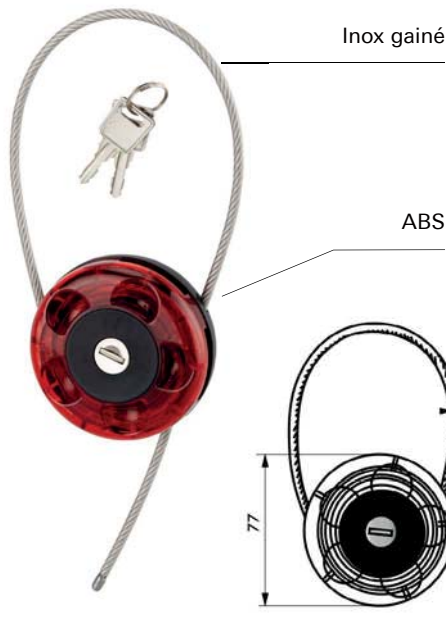

NIVEAU DE SÉCURITÉ



GARANTIE



X 2

Description/Description/Descripción

Corps ABS. Câble inox Ø 4 mm long. 0,75m. Gainé PVC. 2 clés laiton nickelé.
ABS shell. Stainless steel cable Ø 4 mm length 0,75 m PVC sheathed. 2 nickel plated brass keys.

Cuerpo de aleación moldeada. Cable de acero inoxidable Ø 4 mm longitud 0,75 m con revestimiento de PVC. 2 llaves de latón niquelado.

Finition/Finish/Acabado

Couleurs assorties
Assorted colors
Colores surtidos

Utilisation/Use/Utilización

Multifonction
Multifunction
Multifunción

Designation	Boîte	Colis.	Prix	Sachet	Colis.	Prix	Brochable					Colis.	Prix
							France	Euro 1	Euro 2	Euro 3	Euro 4		
Câble enrouleur ROLLER long. 0,75 m 2 clés	-	-	-	-	-	-	00271002	00293290 NS	00292290 NS	00294290	-	10	-

Cadenas à câble / MULTICABLE PROTECT

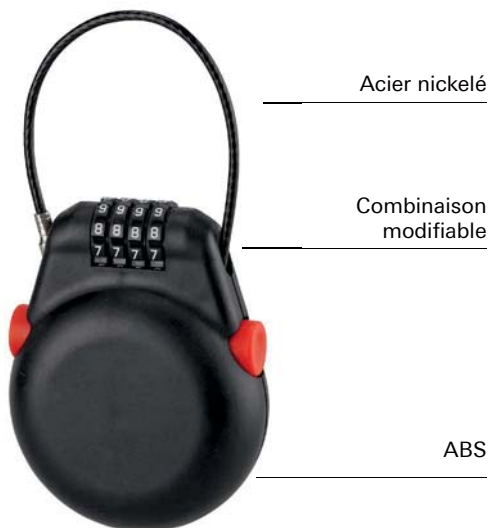

NIVEAU DE SÉCURITÉ



GARANTIE



CODE MODIFIABLE

Description/Description/Descripción

Corps ABS. Câble acier Ø 3 mm long. 1,00 m. Mécanisme à 4 viroles. Combinaison modifiable.

ABS shell. Steel cable Ø 3 mm. length 1,00 m. 3 dial mechanism. Resettable combination.

Cuerpo de ABS. Cable de acero Ø 3 mm. longitud 1,00 m. Mecanismo con 3 virolas. Combinación modificable.

Finition/Finish/Acabado

Noir
Black
Negro

Utilisation/Use/Utilización

Multifonction
Multifunction
Multifunción

Designation	Boîte	Colis.	Prix	Sachet	Colis.	Prix	Brochable					Colis.	Prix
							France	Euro 1	Euro 2	Euro 3	Euro 4		
Câble enrouleur MULTICABLE long. 1,00 m à combinaison modifiable	-	-	-	-	-	-	00271001	00293289 NS	00292289 NS	00294289	-	10	-

NS Non stocké/Non-stored/Producto no estocado - ☑ Sur stock Europe Zone 1 et Zone 2, nous consulter pour délai d'approvisionnement - ☒ Epuisement/Stock depletion/Agotamiento del stock

Cadenas de sûreté / SHOULDER PROTECT



NIVEAU DE SÉCURITÉ



GARANTIE



X 2



Acier nickelé

Laiton



Anse protégée
contre la casse.

Description/Description/Descripción

Corps laiton massif avec protecteur d'anse épaulé. Anse acier cémenté nickelé. Double ancrage. Mécanisme à goupilles. 2 clés acier nickelé.

Solid brass body with raised shoulder guard protected. Hardened nickel plated steel shackle. Double locking. Pin mechanism. 2 nickel plated steel keys.

Cuerpo de latón macizo con protector de arco reforzado. Arco de acero cementado niquelado. Doble anclaje. Mecanismo de pasadores. 2 llaves de acero niquelado.

Finition/Finish/Acabado

Laiton poli

Polished brass

Latón pulido

Versión/Option/Versión

Clés supplémentaires sur modèle. Sans fabrication sur numéro imposé. Cadenas sur même combinaison.

Extra keys with requested model. Without supplying under request number. Keyed alike padlocks available.

Llaves suplementarias sobre modelo. Sin fabricación con número impuesto. Candado con la misma combinación.

Utilisation/Use/Utilización

Extérieur

Outdoor

Exterior

	002400	002500
	40	50
	50	60
	14	17
	22	28
	15	22
	7	9
Goup	5	5

Designation	Boite	Colis.	Prix	Sachet	Colis.	Prix	Brochable				Colis.	Prix	
							France	Euro 1	Euro 2	Euro 3			Euro 4
Cadenas SHOULDER 40 mm	00002400	10	-	00902400	20	-	00102400	00193053 	00192053 	00194053	-	10	-
Cadenas SHOULDER 50 mm	00002500	10	-	00902500	20	-	00102500	00193054 	00192054 	00194054	-	10	-

Non stocké/Non-stored/Producto no estocado - Sur stock Europe Zone 1 et Zone 2, nous consulter pour délai d'approvisionnement - Epuement/Stock depletion/Agotamiento del stock

Cadenas de sûreté / COBBLE PROTECT



NIVEAU DE SÉCURITÉ



GARANTIE



Inox

Aluminium

Description/Description/Descripción

Corps en aluminium massif anodisé. Anse inox. Double verrouillage par billes inox. Mécanisme à goupilles. Bloc de sûreté interchangeable avec protection contre le perçage. 2 clés acier nickelé. *Solid anodized aluminium body. Stainless steel shackle. Double inox ball locking. Pin mechanism. Rekeyable brass cylinder with anti-picking system. 2 nickel plated steel keys.*

Cuerpo de aluminio macizo anodizado. Arco de acero inoxidable. Doble cierre por bolas de acero inoxidable. Mecanismo de pasadores. Bloque de seguridad intercambiable con protección contra el taladrado. 2 llaves de acero niquelado.

Finition/Finish/Acabado

Aluminium anodisé. Couleurs assorties
Anodized aluminium - assorted colors
Aluminio anodizado - colores surtidos

Versión/Option/Versión

Clés supplémentaires sur numéro.
Cadenas sur numéro imposé et sur même combinaison.
Extra keys under requested number. Padlocks under requested number and keyed alike.
Llaves suplementarias sobre número.
Candado con número impuesto y con la misma combinación

Utilisation/Use/Utilización

Extérieur
Outdoor
Exterior



X 2

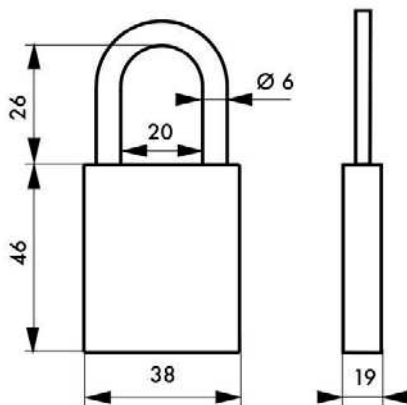

Designation	Boite	Colis.	Prix	Sachet	Colis.	Prix	Brochable					Colis.	Prix
							France	Euro 1	Euro 2	Euro 3	Euro 4		
Cadenas COBBLE 38 mm coul. assorties	00096508	10	-	00996508	20	-	00196508	00193055	00192055	00194055	-	10	-
Cadenas COBBLE 38 mm rouge	00096518	10	-	-	-	-	-	-	-	-	-	-	-
Cadenas COBBLE 38 mm vert	00096528	10	-	-	-	-	-	-	-	-	-	-	-
Cadenas COBBLE 38 mm bleu	00096538	10	-	-	-	-	-	-	-	-	-	-	-
Cadenas COBBLE 38 mm jaune	00096548	10	-	-	-	-	-	-	-	-	-	-	-
Cadenas COBBLE 38 mm noir	00096558	10	-	-	-	-	-	-	-	-	-	-	-

Ⓝ Non stocké/Non-stored/Producto no estocado - Ⓜ Sur stock Europe Zone 1 et Zone 2, nous consulter pour délai d'approvisionnement - Ⓞ Epuisement/Stock depletion/Agotamiento del stock

Cadenas de sûreté / LAND

PROTECT



NIVEAU DE SÉCURITÉ



GARANTIE

Différentes dimensions possibles pour ce land.

Description/Description/Descripción
Corps acier monobloc. Anse acier chromé. Mécanisme à goupilles. Verrouillage par billes. LE CADENAS DOIT ÊTRE FERMÉ POUR PRENDRE LA CLÉ. 3 clés acier nickelé.

Compact steel body. Chrome plated steel shackle. Pin mechanism. Ball locking. THE PADLOCK MUST BE CLOSED TO REMOVE THE KEY. 3 nickel plated steel keys.

Cuerpo de acero monobloque. Arco de acero cromado. Mecanismo de pasadores. Cierre por bolas. EL CANDADO DEBE ESTAR CERRADO PARA RETIRAR LA LLAVE. 3 llaves de acero niquelado

Finition/Finish/Acabado



X 3



Acier chromé

Acier



Acier nickelé

Nickel plated steel

Acero niquelado

Version/Option/Versión

Clés supplémentaires sur modèle. Sans fabrication sur le numéro imposé. Cadenas sur même combinaison.

Extra keys with requested model. Without supplying under request number.

Llaves suplementarias sobre modelo. Sin fabricación con número impuesto. Candado con la misma combinación.

Utilisation/Use/Utilización

Extérieur

Outdoor

Exterior



088500 088650 088750 088794

	50	60	70	90
	42	55	55	55
	18	20	20	20
	24	32	32	32
	14	16	24	30
	9,5	9,5	11	11
Goup.	5	5	5	5

Designation	Boite	Colis.	Prix	Sachet	Colis.	Prix	Brochable					Colis.	Prix
							France	Euro 1	Euro 2	Euro 3	Euro 4		
Cadenas LAND 50 mm	00088500	10	-	-	-	-	00188500	00193649 NS	00192649 NS	00194649	-	10	-
Cadenas LAND 60 mm	00088650	10	-	-	-	-	00188650	00193050 NS	00192050 NS	00194050	-	10	-
Cadenas LAND 70 mm	00088750	10	-	00988750	20	-	00188750	00193051 NS	00192051 NS	00194051	-	10	-
Cadenas LAND 90 mm	00088794	10	-	00988794	20	-	00188794	00193052 NS	00192052 NS	00194052	-	10	-
Cadenas LAND 60 mm s'ouvrant anse inox, avec trou Ø 5 mm	00088659 NS	10	-	-	-	-	-	-	-	-	-	-	-
Jeu de 2 Cadenas LAND 70 mm s'ouvrant 6 clés	-	-	-	-	-	-	00288752	00293001	00292001	00294001	-	10	-
Jeu de 2 Cadenas LAND 90 mm s'ouvrant 6 clés	-	-	-	-	-	-	00288792	00293002	00292002	00294002	-	10	-

NS Non stocké/Non-stored/Producto no estocado - Sur stock Europe Zone 1 et Zone 2, nous consulter pour délai d'approvisionnement - E Epuement/Stock depletion/Agotamiento del stock

Cadenas de sûreté / DISK PROTECT



NIVEAU DE SÉCURITÉ



GARANTIE



Acier cémenté
nickelé



Acier chromé



	40 mm	50 mm	60 mm
40	40	50	60
32	32	38	42
20	20	20	20
23	23	28	33
20	20	23	27
7	7	8,5	9,5



X 4

Description/Description/Descripción

Corps acier chromé. Anse acier cémenté nickelé.
Mécanisme à disques. Double verrouillage. 4 clés.
Chrome-plated steel body. Case-hardened nickel-plated steel shackle. Discs mechanism. Double locking. 4 keys.
Cuerpo de acero cromado. Arco de acero cementado niquelado. Mecanismo de discos. Doble bloqueo. 4 llaves.

Finition/Finish/Acabado

Acier chromé
Steel chrome plated
Acero cromado

Utilisation/Use/Utilización

Chantier
Construction sites
Obras de construcción

Designation	Boite	Colis.	Prix	Sachet	Colis.	Prix	Brochable					Colis.	Prix
							France	Euro 1	Euro 2	Euro 3	Euro 4		
Cadenas DISK 40 mm	00095515	10	-	-	-	-	00295515	00293810 NS	00292810 NS	00294810	-	10	-
Cadenas DISK 50 mm	00095516	10	-	-	-	-	00295516	00293811 NS	00292811 NS	00294811	-	10	-
Cadenas DISK 60 mm	00095517	10	-	-	-	-	00295517	00293812 NS	00292812 NS	00294812	-	10	-

Cadenas de sûreté / 258 PROTECT



NIVEAU DE SÉCURITÉ



GARANTIE



Acier cémenté
nickelé

Laiton

Combinaison
modifiable

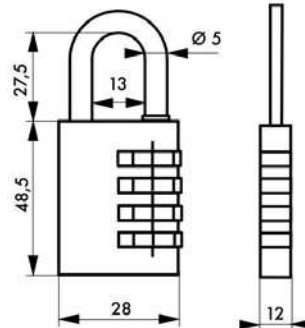

CODE
MODIFIABLE

Description/Description/Descripción

Corps laiton monobloc. Anse acier nickelé. Mécanisme à 4 viroles. Combinaison modifiable.
Compact brass body. Nickel plated steel shackle. 4 Dial mechanism. Resettable combination.
Cuerpo de latón monobloque. Arco de acero niquelado. Mecanismo con 4 virolas. Combinación modificable.

Finition/Finish/Acabado

Laiton poli / *Polished brass* / Latón pulido

Utilisation/Use/Utilización

Intérieur / *Indoor* / Interior

Designation	Boite	Colis.	Prix	Sachet	Colis.	Prix	Brochable					Colis.	Prix
							France	Euro 1	Euro 2	Euro 3	Euro 4		
Cadenas 258 • 28 mm à combinaison modifiable	00000258	10	-	00900258	10	-	00100258	00193058 NS	00192058 NS	00194058	-	10	-

NS Non stocké/Non-stored/Producto no estocado - ☐ Sur stock Europe Zone 1 et Zone 2, nous consulter pour délai d'approvisionnement - ☒ Epuisement/Stock depletion/Agotamiento del stock

Cadenas de sûreté / VENUS PROTECT



NIVEAU DE SÉCURITÉ



GARANTIE



Acier cémenté
nickelé

Laiton

Combinaison
modifiable

	30mm	40mm
	30	40
	31	37
	13	13
	22	27
	16	25
	4	5

Description/Description/Descripción

Corps alliage. Anse acier nickelé.
Mécanisme à viroles. Combinaison modifiable.
Alloy body. Nickel plated steel shackle. Dial mechanism. Resettable combination.
Cuerpo de aleación. Arco de acero niquelado. Mecanismo con virolas. Combinación modificable.

Finition/Finish/Acabado

Laitonné
Brass plated.
Latonado

Utilisation/Use/Utilización

Intérieur
Indoor
Interior



CODE
MODIFIABLE

Designation	Boite	Colis.	Prix	Sachet	Colis.	Prix	Brochable					Colis.	Prix
							France	Euro 1	Euro 2	Euro 3	Euro 4		
Cadenas VENUS 30 mm à 3 viroles	00090801	10	-	00990801	10	-	00190801	00193240 NS	00192240 NS	00194240	-	10	-
Cadenas VENUS 40 mm à 4 viroles	00090802	10	-	00990802	10	-	00190802	00193241 NS	00192241 NS	00194241	-	10	-

Cadenas de sûreté / CLUB 2 PROTECT



NIVEAU DE SÉCURITÉ



GARANTIE



Acier cémenté
nickelé

Alliage moulé

Combinaison
modifiable

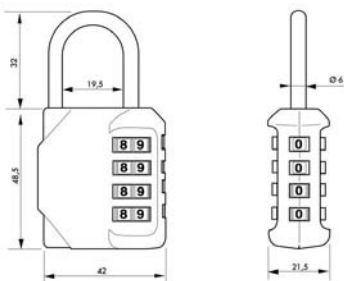

Description/Description/Descripción

Corps alliage moulé. Anse acier nickelé.
Mécanisme à 4 viroles. Combinaison modifiable.
Moulded alloy body. Nickel plated steel shackle. 4 Dial mechanism. Resettable combination.
Cuerpo de aleación moldeada. Arco de acero niquelado. Mecanismo con 4 virolas. Combinación modificable.

Finition/Finish/Acabado

Argent
Silver
Plata

Utilisation/Use/Utilización

Intérieur
Indoor
Interior



CODE
MODIFIABLE

Designation	Boite	Colis.	Prix	Sachet	Colis.	Prix	Brochable					Colis.	Prix
							France	Euro 1	Euro 2	Euro 3	Euro 4		
Cadenas CLUB 2 • 40 mm à combinaison modifiable	-	-	-	00971024	10	-	00171024	00193296 NS	00192296 NS	00194296	-	10	-

NS Non stocké/Non-stored/Producto no estocado - Sur stock Europe Zone 1 et Zone 2, nous consulter pour délai d'approvisionnement - E Epuisement/Stock depletion/Agotamiento del stock

Cadenas de sûreté / BAGGY PROTECT



NIVEAU DE SÉCURITÉ



GARANTIE



Acier cémenté
nickelé

Alliage moulé

Combinaison
modifiable

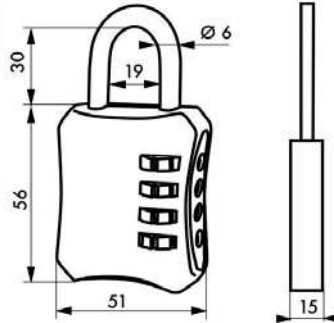

Description/Description/Descripción

Corps alliage moulé. Anse acier nickelé.
Mécanisme à 4 viroles. Combinaison
modifiable.

*Moulded alloy body. Nickel plated steel
shackle. 4 dial mechanism. Resettable
combination.*

Cuerpo de aleación moldeada. Arco de
acero niquelado. Mecanismo con 4 virolas.
Combinación modificable.

Finition/Finish/Acabado

Bicolore

Bicolor

Bicolor

Utilisation/Use/Utilización

Intérieur

Indoor

Indoor



CODE
MODIFIABLE

Designation	Boite	Colis.	Prix	Sachet	Colis.	Prix	Brochable					Colis.	Prix
							France	Euro 1	Euro 2	Euro 3	Euro 4		
Cadenas BAGGY 50 mm à combinaison modifiable	00071016 NS	10	-	-	-	-	00171016	00193293 NS	00192293 NS	00194293	-	10	-

Cadenas de sûreté / M 54 PROTECT



NIVEAU DE SÉCURITÉ



GARANTIE



Acier cémenté
nickelé

Alliage moulé

Combinaison
modifiable

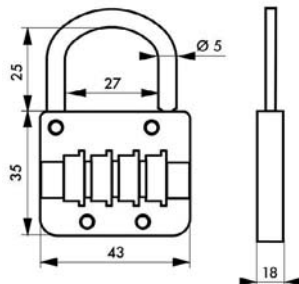

Description/Description/Descripción

Corps alliage moulé. Anse alliage nickelé.
Mécanisme à 4 viroles laiton. Combinaison
modifiable, 10 000 combinaisons possibles.

*Moulded alloy body. Nickel plated alloy
shackle. 4 brass dials mechanism. Resettable
combination, 10 000 possible combinations.*

Cuerpo de aleación moldeada. Arco de
aleación niquelada. Mecanismo con 4 virolas
de latón. Combinación modificable 10.000
combinaciones posibles.

Finition/Finish/Acabado

Nickelé / *Nickel plated* / Niquelado

Versión/Option/Versión

Lettres ou chiffres

Letters or numbers

Letras o números

Utilisation/Use/Utilización

Intérieur / *Indoor* / Interior



CODE
MODIFIABLE

Designation	Boite	Colis.	Prix	Sachet	Colis.	Prix	Brochable					Colis.	Prix
							France	Euro 1	Euro 2	Euro 3	Euro 4		
Cadenas M 54 • 4 viroles lettres	00005441	10	-	00905441	10	-	00105441	-	-	-	-	10	-
Cadenas M 54 • 4 viroles chiffres	00005442	10	-	00905442	10	-	00105442	-	-	-	-	10	-

NS Non stocké/Non-stored/Producto no estocado - S Sur stock Europe Zone 1 et Zone 2, nous consulter pour délai d'approvisionnement - E Epuisement/Stock depletion/Agotamiento del stock

Cadenas de sûreté / SATURN PROTECT



Acier cémenté
nickelé

Alliage

Combinaison
modifiable

Description/Description/Descripción

Corps alliage monobloc. Anse acier cémenté nickelé.
Verrouillage par bille acier. Mécanisme à 4 ou 5 viroles.
10 000 combinaisons possibles.
*Moulded alloy body. Hardened nickel plated steel shackle.
Steel ball locking. Mechanism with 4 or 5 dials. 10 000
combinations available.*
Cuerpo monobloque. Arco de acero cementado
níquelado. Cierre por bola de acero. Mecanismo con 4 ó
5 virolas. 10.000 combinaciones posibles.

ANSE DEMI HAUTE	
092860	092861
65	60,4
33	31,8
27	26,7
23	47
41	37
7	Ø 6,9



NIVEAU DE SÉCURITÉ



GARANTIE

Système à molette
facilitant l'ouverture
même dans
l'obscurité,
10 000 combinaisons
possibles.



CODE
MODIFIABLE

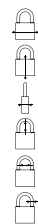

Finition/Finish/Acabado

Nickelé - couleurs assorties
Nickel plated - assorted colors
Níquelado - colores surtidos

Version/Option/Versión

Anse demi haute. / Demi long shackle.
Arco semialto.

Utilisation/Use/Utilización

Intérieur / Indoor / Interior

Designation	Boite	Colis.	Prix	Sachet	Colis.	Prix	Brochable					Colis.	Prix
							France	Euro 1	Euro 2	Euro 3	Euro 4		
Cadenas SATURN à combinaison modifiable	00092860	10	-	00992860	10	-	00192860	00193057	00192057	00194057	-	10	-
Cadenas SATURN anse 1/2 haute à combinaison modifiable	00092861	10	-	-	-	-	-	-	-	-	-	-	-

Cadenas de sûreté / THOR PROTECT



Acier cémenté
nickelé

Acier cémenté
nickelé



Description/Description/Descripción

Corps acier cémenté chromé. Anse acier cémenté.
Mécanisme à goupilles. 5 clés réversibles.
*Chrome-plated case-hardened steel body. Case-hardened
steel shackle. Pins mechanism. 5 reversible keys.*
Cuerpo de acero cementado cromado. Arco de
acero cementado. Mecanismo de pasadores. 5 llaves
reversibles.

	74 mm	84 mm	94 mm
74	74	84	94
70	70	70	70
28	28	28	28
16	16	16	16
27	38	40	
11,5	12,5	12,5	
Goup.	6	6	6



NIVEAU DE SÉCURITÉ



GARANTIE

Finition/Finish/Acabado

Nickel satin / *Nickel satin* / Níquel satinado

Utilisation/Use/Utilización

Chantier / *Construction sites*
Obras de construcción

Designation	Boite	Colis.	Prix	Sachet	Colis.	Prix	Brochable					Colis.	Prix
							France	Euro 1	Euro 2	Euro 3	Euro 4		
Cadenas THOR 74 mm	00089740	6	-	-	-	-	00289740	00293830	00292830	00294830	-	10	-
Cadenas THOR 84 mm	00089840	10	-	-	-	-	00289840	00293831	00292831	00294831	-	10	-
Cadenas THOR 94 mm	00089940	10	-	-	-	-	00289940	00293832	00292832	00294832	-	10	-

NS Non stocké/Non-stored/Producto no estocado - S Sur stock Europe Zone 1 et Zone 2, nous consulter pour délai d'approvisionnement - E Epuisement/Stock depletion/Agotamiento del stock

Cadenas de sûreté / CODE-X PROTECT



NIVEAU DE SÛRETÉ



GARANTIE



Acier cémenté
nickelé nickelé

Alliage

Combinaison
modifiable

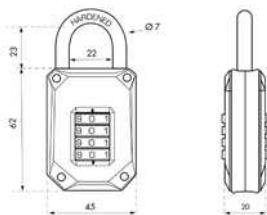

Description/Description/Descripción

Corps alliage moulé. Anse acier cémenté nickelé. Mécanisme à 4 viroles. Combinaison modifiable

Moulded alloy body. Hardened nickel plated steel shackle. 4 dial mechanism. Resettable combination.

Cuerpo de aleación moldeada. arco de acero cementado niquelado. Mecanismo con 4 virolas. Combinación modificable

Finition/Finish/Acabado

Noir / Black / Negro

Utilisation/Use/Utilización

Intérieur / Indoor / Interior



CODE
MODIFIABLE

Designation	Boite	Colis.	Prix	Sachet	Colis.	Prix	Brochable					Colis.	Prix
							France	Euro 1	Euro 2	Euro 3	Euro 4		
Cadenas Code-X 45 mm combinaison modifiable	00090068	10	-	-	-	-	00190068	00193321 NS	00192321 NS	00194321	-	10	-

Cadenas de sûreté / DIGITAL PROTECT

Déverrouillage par
empreinte digitale

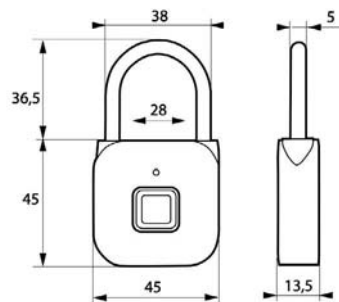

GARANTIE



CODE
MODIFIABLE

Description/Description/Descripción

Corps alliage. Anse acier nickelé. Ouverture par empreinte digitale. Rechargeable par câble Usb, charge complète en 30min. DC 3.7V - 100mAh - batterie lithium. Indicateur de batterie faible. Fonctionnement -20°C/+60°C. Possibilité d'enregistrer jusqu'à 39 empreintes.

Alloy body. Nickel-plated steel handle. Opening by fingerprint. Rechargeable by Usb cable, full charge in 30min. DC 3.7V - 100mAh - lithium battery. Low battery indicator. Operation -20 °C / + 60 °C. Ability to register up to 39 fingerprints.

Cuerpo de aleación. Arco de acero niquelado. Apertura por huella digital. Recargable por cable USB, carga completa en 30 minutos. DC 3.7V - 100mAh - batería de litio. Indicador de batería baja. Operación -20 °C / + 60 °C. Posibilidad de registrar hasta 39 huellas digitales.

Finition/Finish/Acabado

Gris satin / SATIN GREY / Gris satinado

Designation	Boite	Colis.	Prix	Sachet	Colis.	Prix	Brochable					Colis.	Prix
							France	Euro 1	Euro 2	Euro 3	Euro 4		
Cadenas digital nickel satin	-	-	-	-	-	-	00102008	00194085	10094085	00194085	00194085	5	-

NS Non stocké/Non-stored/Producto no estocado - E Sur stock Europe Zone 1 et Zone 2, nous consulter pour délai d'approvisionnement - E Epuisement/Stock depletion/Agotamiento del stock

Cadenas de sûreté / DIGITAL COLOR PROTECT



GARANTIE



CODE
MODIFIABLE



Déverouillage par empreinte digitale
/ IP65: étanche à la poussière et
protégé contre les projections d'eau

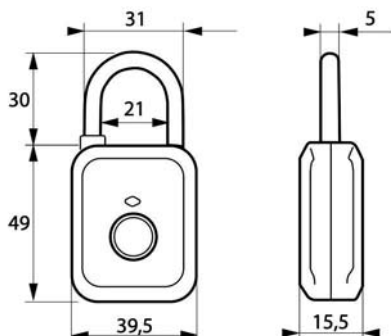

Description/Description/Descripción

Corps alliage. Anse acier nickelé. Capteur d'empreinte digitale. Rechargeable par câble Usb(câble fourni).
Alloy body. Nickel-plated steel shackle. Opening by fingerprint. Rechargeable by Usb cable (cable supplied).
Cuerpo de aleación. Arco de acero niquelado Apertura por huella digital. Recargable por cable USB (cable suministrado).

Finition/Finish/Acabado

Jaune, Rouge, Vert / *Yellow, red, green*
Amarillo, rojo, verde

Designation	Boite	Colis.	Prix	Sachet	Colis.	Prix	Brochable					Colis.	Prix
							France	Euro 1	Euro 2	Euro 3	Euro 4		
Cadenas digital color jaune	-	-	-	-	-	-	00102010	00194071	00194071	00194071	00194071	5	-
Cadenas digital color rouge	-	-	-	-	-	-	00102011	00194072	00194072	00194072	00194072	5	-
Cadenas digital color vert	-	-	-	-	-	-	00102012	00194073	00194073	00194073	00194073	5	-

⚠ Non stocké/Non-stored/Producto no estocado - 📦 Sur stock Europe Zone 1 et Zone 2, nous consulter pour délai d'approvisionnement - ⚠ Epuisement/Stock depletion/Agotamiento del stock

Cadenas de sûreté / TYPE 1 RESIST



NIVEAU DE SÉCURITÉ



GARANTIE



X 2

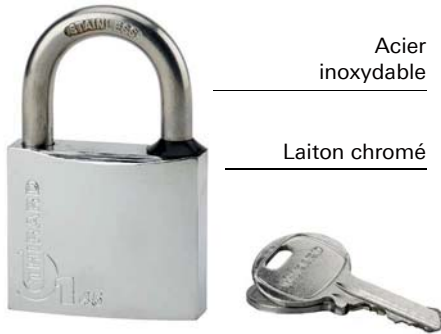

Acier
inoxydable

Laiton chromé

Description/Description/Descripción

Corps laiton chromé monobloc. Anse acier inoxydable. Mécanisme à goupilles. Double ancrage. Trou d'écoulement d'eau. 2 clés acier nickelé.

Brass body. Stainless steel shackle. Pin mechanism. Double locking. Flow through water hole. 2 nickel plated steel keys.
Cuerpo de latón. Arco de acero inoxidable. Mecanismo de pasadores. Doble anclaje. Orificio de circulación de agua. 2 llaves de acero niquelado.

Finition/Finish/Acabado

Chromé
Chrome plated
Cromado

Version/Option/Versión

Anse 1/2 haute pour taille 30 mm.
Anse haute pour taille 40 mm. Clés supplémentaires sur modèle. Sans fabrication sur numéro imposé.
1/2 long shackle for size 30 mm. Long shackle for size 40 mm. Extra keys with model. Without manufacturing under request number.

Arco semialto para tamaño 30 mm.
Arco alto para tamaños 40 mm. Llaves suplementarias sobre modelo. Sin fabricación con número impuesto.

Utilisation/Use/Utilización

Extérieur, anti-corrosion
Outdoor, Weather proof
Exterior, Anticorrosión

Designation	Boite	Colis.	Prix	Sachet	Colis.	Prix	Brochable					Colis.	Prix
							France	Euro 1	Euro 2	Euro 3	Euro 4		
TYPE 1 • 30 mm	00080130	10	-	00980130	20	-	00180130	00193028 NS	00192028 NS	00194028	-	10	-
TYPE 1 • 30 mm anse 1/2 haute	00080132	10	-	-	-	-	00180132	00193007 NS	00192007 NS	00194007	-	10	-
TYPE 1 • 35 mm	00080135	10	-	00980135	20	-	00180135	00193029 NS	00192029 NS	00194029	-	10	-
TYPE 1 • 40 mm	00080140	10	-	00980140	20	-	00180140	00193030 NS	00192030 NS	00194030	-	10	-
TYPE 1 • 40 mm anse haute	00080142	10	-	-	-	-	00280142	00293031 NS	00292031 NS	00294031	-	10	-
TYPE 1 • 45 mm	00080145	10	-	00980145	20	-	00180145	00193032 NS	00192032 NS	00194032	-	10	-
TYPE 1 • 50 mm	00080150	10	-	00980150	20	-	00180150	00193033 NS	00192033 NS	00194033	-	10	-
TYPE 1 • 50 mm anse haute	00080151	10	-	-	-	-	00280151	00293032 NS	00292032 NS	00294032	-	10	-
TYPE 1 • 60 mm	00080160	10	-	-	-	-	00280160	00293038 NS	00292038 NS	00294038	-	10	-
Jeu de 3 cadenas TYPE 1 • 30 mm s'ouvrant 6 clés	-	-	-	-	-	-	00280130	00293006 NS	00292006 NS	00294006	-	10	-

NS Non stocké/Non-stored/Producto no estocado - ☐ Sur stock Europe Zone 1 et Zone 2, nous consulter pour délai d'approvisionnement - ☒ Epuisement/Stock depletion/Agotamiento del stock

Cadenas de sûreté / TYPE 1 RESIST



NIVEAU DE SÉCURITÉ



GARANTIE



X 2

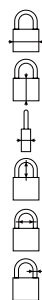

Goup.

	30 mm	35 mm	40 mm	45 mm	50 mm	60 mm	ANSE DEMI HAUTE	ANSE HAUTE	
							30 mm	40 mm	50 mm
	30	35	40	45	50	60	30	40	50
	29	30	33	33	41	50	29	33	41
	13	13,5	14	14	17	18,5	13	14	17
	17	20,5	22	27	29	37,5	56	130	130
	15	19	20	25	28	32	15	20	28
	5	5,5	6	7	8	9,5	5	6	8
Goup.	4	5	5	5	5	5	4	5	5

Cadenas de sûreté / SLICE RESIST



NIVEAU DE SÉCURITÉ



GARANTIE



Acier cémenté

Lamelles acier



	40mm	50mm	65mm
	40	50	65
	32	38	46
	22,5	26	31
	20	29	38
	22	24	31
	6,5	9	11
Goup.	4	4	4

Description/Description/Descripción
Corps à lamelles acier. Anse acier cémenté nickelé. Mécanisme à goupilles. Double ancrage. 2 clés laiton nickelé

Laminated steel body. Hardened steel shackle. Pin mechanism. Double locking. 2 nickel plated brass keys.

Cuerpo de láminas de acero. Arco de acero cementado níquelado. Mecanismo de pasadores. Doble anclaje. 2 llaves de latón níquelado

Finition/Finish/Acabado

Zingué / Zinc plated / Cincado

Version/Option/Versión

Clés supplémentaires sur modèle. Sans fabrication sur numéro imposé. Cadenas sur même combinaison. *Extra keys with requested model. Without supplying under request number. Keyed alike padlocks available.* Llaves suplementarias sobre modelo. Sin fabricación con número impuesto. Candado con la misma combinación.

Utilisation/Use/Utilización

Intérieur / Indoor / Interior



X 2

Designation	Boite	Colis.	Prix	Sachet	Colis.	Prix	Brochable					Colis.	Prix
							France	Euro 1	Euro 2	Euro 3	Euro 4		
Cadenas SLICE à lamelles 40 mm	-	-	-	-	-	-	00190045	00193038 NS	00192038 NS	00194038	-	10	-
Cadenas SLICE à lamelles 50 mm	-	-	-	00990046	20	-	00190046	00193226 NS	00192226 NS	00194226	-	10	-
Cadenas SLICE 65 mm	-	-	-	00990047	10	-	00290047	00293227 NS	00292227 NS	00294227	-	10	-
Lot de 2 cadenas SLICE à lamelles 40 mm 4 clés	-	-	-	-	-	-	00290045	-	-	-	-	10	-
Lot de 2 cadenas SLICE à lamelles 50 mm 4 clés	-	-	-	-	-	-	00290046	-	-	-	-	10	-

Cadenas de sûreté / UPPER RESIST



NIVEAU DE SÉCURITÉ



GARANTIE



Acier cémenté

Lamelles acier

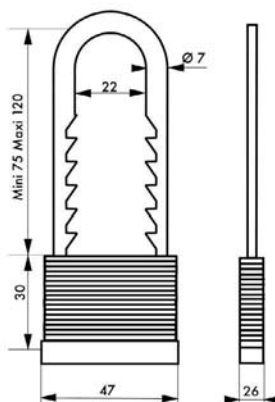

Description/Description/Descripción
Corps à lamelles acier zingué protégé par bague PVC. Anse acier. Mécanisme à disques. 2 clés acier nickelé.

Laminated zinc plated steel body with PVC bumper. Steel shackle. Disk mechanism. 2 nickel plated steel keys.

Cuerpo de láminas de acero cincado. protegido con anillo de PVC. Arco de acero. Mecanismo de discos. 2 llaves de acero níquelado

Finition/Finish/Acabado

Zingué - couleurs assorties. / Zinc plated - assorted colors / Cincado - colores surtidos

Utilisation/Use/Utilización

Intérieur / Indoor / Interior



X 2

Designation	Boite	Colis.	Prix	Sachet	Colis.	Prix	Brochable					Colis.	Prix
							France	Euro 1	Euro 2	Euro 3	Euro 4		
Cadenas UPPER anse réglable Ø 7mm couleurs assorties	-	-	-	-	-	-	00202050	00293049 NS	00292049 NS	00294049	-	10	-

Cadenas de sûreté / SLICE RESIST



NIVEAU DE SÉCURITÉ



GARANTIE



Acier gainé
PVC

Acier gainé
PVC



Description/Description/Descripción

Corps à lamelles acier. Anse acier cimenté nickelé. Mécanisme à goupilles. Double ancrage. 2 clés laiton nickelé.

Laminated steel body. Hardened steel shackle. Pin mechanism. Double locking. 2 nickel plated brass keys.

Cuerpo de láminas de acero. Arco de acero cementado níquelado. Mecanismo de pasadores. Doble anclaje. 2 llaves de latón níquelado.

Finition/Finish/Acabado

PVC couleurs assorties

Assorted colours PVC

PVC colores surtidos

Version/Option/Versión

Anse demi-haute. Clés supplémentaires sur modèle. Sans fabrication sur numéro imposé. Cadenas sur même combinaison.

Demi long shackle. Extra keys with requested model. Without supplying under request number. Keyed alike padlocks available.

Arco semialto. Llaves suplementarias sobre modelo. Sin fabricación con número impuesto. Candado con la misma combinación.

Utilisation/Use/Utilización

Extérieur

Outdoor

Exterior



X 2



	40 mm	50 mm	65 mm	ANSE DEMI HAUTE 40 mm
	46	55	70	46
	38	44	55	38
	29	28	36	29
	25	38	48	50
	20	23	28	20
	8	10	13	8
Goup.	4	4	4	4

Designation	Boîte	Colis.	Prix	Sachet	Colis.	Prix	Brochable					Colis.	Prix
							France	Euro 1	Euro 2	Euro 3	Euro 4		
Cadenas SLICE à lamelles 40 mm gainé PVC couleurs assorties	-	-	-	00900901	10	-	00100901	00193039 NSI	00192039 NSI	00194039	-	10	-
Cadenas SLICE à lamelles 40 mm anse 1/2haute gainé PVC couleurs assorties	00000911	10	-	-	-	-	-	00193037 NSI	00192037 NSI	-	-	10	-
Cadenas SLICE à lamelles 50 mm gainé PVC couleurs assorties	00000918	10	-	-	-	-	00100918	00193225 NSI	00192225 NSI	00194027	-	10	-
Cadenas SLICE gainé 65 mm	00000919	10	-	-	-	-	00200919	00293228 NSI	00292228 NSI	00294028	-	10	-

NSI Non stocké/Non-stored/Producto no estocado - Sur stock Europe Zone 1 et Zone 2, nous consulter pour délai d'approvisionnement - E Epuement/Stock depletion/Agotamiento del stock

Cadenas de sûreté / ASTRA + RESIST

Acier cémenté



Inox

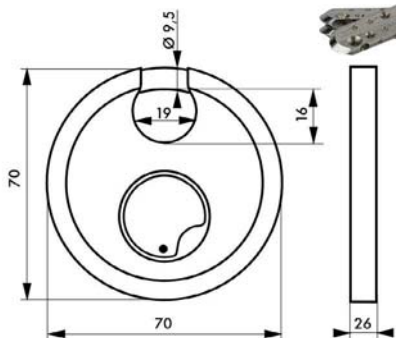

NIVEAU DE SÉCURITÉ



GARANTIE



X 3

Description/Description/Descripción

Corps inox. Anse acier cémenté. Mécanisme à goupilles. Protecteur de cylindre. 3 Clés réversibles laiton nickelé.

Stainless steel body. Case-hardened steel shackle. Pins mechanism. Cylinder protector. 3 reversible keys in nickel-plated steel.

Cuerpo de acero inoxidable. Arco de acero cementado. Mecanismo de pasadores. Protector de cilindro. 3 llaves reversibles de latón niquelado.

Finition/Finish/Acabado

Inox poli

Polished stainless steel

Acero inoxidable pulido

Utilisation/Use/Utilización

Intérieur / Indoor / Interior

Designation	Boite	Colis.	Prix	Sachet	Colis.	Prix	Brochable					Colis.	Prix
							France	Euro 1	Euro 2	Euro 3	Euro 4		
Cadenas ASTRA+ 70 mm - 3 clés réver.	00091700	10	-	-	-	-	00191700	00193829 NS	00192829 NS	00194829	-	10	-

Cadenas de sûreté / TANK RESIST

Acier cémenté



Lamelles acier

Combinaison modifiable

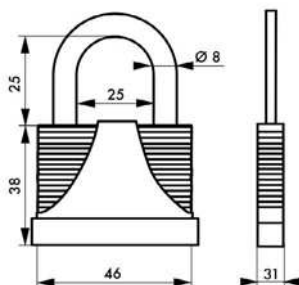

NIVEAU DE SÉCURITÉ



GARANTIE



CODE MODIFIABLE

Description/Description/Descripción

Corps à lamelles acier zingué protégé avec bague PVC. Anse acier cémenté nickelé.

Mécanisme à 4 viroles laiton. Double verrouillage. Combinaison modifiable, 10 000 combinaisons possibles.

Laminated zinc plated steel body with PVC bumper. Hardened nickel plated steel shackle. 4 brass dials mechanism. Double locking. Resettable mechanism, 10 000 possible combinations.

Cuerpo de láminas de acero cincado protegido con un anillo de PVC.

Arco de acero cementado niquelado.

Mécanisme con 4 virolas latón - Double cierre. Combinaison modifiable, 10.000 combinaciones posibles.

Finition/Finish/Acabado

Zingué - couleurs assorties.

Zinc plated - assorted colors

Cincado - colores surtidos

Utilisation/Use/Utilización

Intérieur / Indoor / Interior

Designation	Boite	Colis.	Prix	Sachet	Colis.	Prix	Brochable					Colis.	Prix
							France	Euro 1	Euro 2	Euro 3	Euro 4		
Cadenas TANK 4 chiffres combinaison modifiable	-	-	-	00946000	10	-	00146000	00193201 NS	00192201 NS	00194201	-	6	-

NS Non stocké/Non-stored/Producto no estocado - S Sur stock Europe Zone 1 et Zone 2, nous consulter pour délai d'approvisionnement - E Epuisement/Stock depletion/Agotamiento del stock

Cadenas de sûreté / RUCK RESIST



NIVEAU DE SÉCURITÉ



GARANTIE



Acier Molybdène

Laiton



Description/Description/Descripción

Corps laiton. Anse en acier au molybdène. Mécanisme à goupilles. Protection contre le perçage et le crochetage par 2 goupilles en acier traité. Double verrouillage. Joints d'étanchéité. 2 clés.

Brass body. Hardened anti-cut molybdenum shackle. Pins mechanism. Protection against drilling and picking by 2 pins in treated steel. Double locking. Tightness seals. 2 keys.

Cuerpo de latón. Arco de acero al molibdeno. Mecanismo de pasadores. Protección contra la perforación y el forzamiento mediante 2 pasadores de acero tratado. Doble bloqueo. Juntas de estanqueidad. 2 llaves.

Finition/Finish/Acabado

Laiton poli

Polished brass

Latón pulido

Utilisation/Use/Utilización

Intérieur

Indoor

Interior



X 2



	ANSE DEMI HAUTE							
	30 mm	40 mm	50 mm	60 mm	30 mm	40 mm	50 mm	
	30	40	50	60	30	40	50	
	27	33	40	42	27	33	40	
	11	13	14	15	11	13	14	
	16	22	30	27	56	56	56	
	15	22	28	32	15	22	28	
	4,5	6	7,5	8,5	4,5	6	7,5	
Goup.	4	5	5	5	4	5	5	

Designation	Boite	Colis.	Prix	Sachet	Colis.	Prix	Brochable					Colis.	Prix
							France	Euro 1	Euro 2	Euro 3	Euro 4		
Cadenas RUCK 30 mm	-	-	-	00982030	10	-	00182030	-	-	00194730	-	10	-
Cadenas RUCK 30 mm anse 1/2 haute	-	-	-	00982630	10	-	00182630	-	-	00194575	-	10	-
Cadenas RUCK 40 mm	-	-	-	00982040	10	-	00182040	-	-	00194732	-	10	-
Cadenas RUCK 40 mm anse 1/2 haute	-	-	-	00982640	10	-	00182640	-	-	00194576	-	10	-
Cadenas RUCK 50 mm	-	-	-	00982050	10	-	00182050	-	-	10094734	-	10	-
Cadenas RUCK 50 mm anse 1/2 haute	-	-	-	00982650	10	-	00182650	-	-	-	-	10	-
Cadenas RUCK 60 mm	-	-	-	00982060	10	-	00182060	-	-	00194754	-	10	-

Non stocké/Non-stored/Producto no estocado - Sur stock Europe Zone 1 et Zone 2, nous consulter pour délai d'approvisionnement - Epuement/Stock depletion/Agotamiento del stock

Cadenas de sûreté / TYPE 1+ RESIST



NIVEAU DE SÉCURITÉ



GARANTIE



X 2



Acier cémenté
nickelé

Laiton

Description/Description/Descripción

Corps laiton monobloc. Anse acier cémenté nickelé. Mécanisme à goupilles. Double ancrage. 2 clés acier nickelé.

Compact brass body. Hardened nickel plated steel shackle. Pin mechanism. Double locking. 2 nickel plated steel keys.

Cuerpo de latón monobloque. Arco de acero cementado níquelado. Mecanismo de pasadores. Doble anclaje. 2 llaves de acero níquelado. Acabado Latón pulido.

Finition/Finish/Acabado

Laiton poli

Polished brass

Latón pulido

Version/Option/Versión

Simple ancrage pour taille 30 - 35 mm. Anse demi haute pour taille 30-40-50 mm. Anse haute pour taille 40-45 mm. Clés supplémentaires sur modèle. Sans fabrication sur numéro imposé. Cadenas sur même combinaison pour taille 30, 35, 40, 45, 50 mm.

Simple locking 30 - 35 mm. Demi long shackle for size 30-40-50 mm. Long shackle for size 40-45 mm. Extra keys with model. Without manufacturing under request number. Keyed alike padlocks for size 30, 35, 40, 45, 50 mm available.

Simple anclaje 30 - 35 mm. Arco semialto para tamaño 30-40-50 mm. Arco alto para tamaños 40-45 mm. Llaves suplementarias sobre modelo Sin fabricación con número impuesto Candado con la misma combinación para tamaños 30, 35, 40, 45, 50 mm

Utilisation/Use/Utilización

Intérieur

Indoor

Interior

								ANSE DEMI HAUTE			ANSE HAUTE		
	30mm	35mm	40mm	45mm	50mm	60 mm	70 mm	30mm	40mm	50mm	40mm	45mm	60 mm
	30	35	40	45	48,5	57,7	70	30	40	50	40	45	60
	27	28,5	33	32,5	37,5	42	43	27	33	42	33	38	50,5
	11	12	14	13	15,5	17,5	19	14	14,5	17	14,5	15,5	18,5
	19,5	18,8	26,5	27,5	28	36	44	53	58	53	130	125	130
	15	16	22	24	27	31	39	15	21	25	21	29	31
	5	5,2	6	7	8	10	11	5,5	6	9	6	7	10
Goup.	5	4	5	5	5	6	6	4	5	5	5	5	5

Cadenas de sûreté / TYPE 1+

RESIST



NIVEAU DE SÉCURITÉ



GARANTIE



Designation	Boite	Colis.	Prix	Sachet	Colis.	Prix	Brochable					Colis.	Prix
							France	Euro 1	Euro 2	Euro 3	Euro 4		
CADENAS TYPE 1+ 30 mm	00080030	10	-	00988030	10	-	00188030	00193735 NS	00192735 NS	00194735	-	10	-
CADENAS TYPE 1+ 30 mm anse 1/2 haute	00080630	10	-	00988630	10	-	00188630	-	-	00194758	-	10	-
CADENAS TYPE 1+ 35 mm	00080035	10	-	00988035	10	-	00188035	00193751 NS	00192751 NS	00194751	-	10	-
CADENAS TYPE 1+ 40 mm	00080040	10	-	00988040	10	-	00188040	00193736 NS	00192736 NS	00194736	-	10	-
CADENAS TYPE 1+ 40 mm anse 1/2 haute 44mm	-	-	-	-	-	-	-	-	-	00194759	-	10	-
CADENAS TYPE 1+ 40 mm anse 1/2 haute 58mm	00080640	10	-	00988640	10	-	00188640	00193760 NS	00192760 NS	00194760	-	10	-
CADENAS TYPE 1+ 40 mm anse haute	00080042	10	-	00988042	10	-	00288042	00293740 NS	00292740 NS	00294740	-	10	-
CADENAS TYPE 1+ 45 mm	00080045	10	-	00988045	10	-	00188045	00193752 NS	00192752 NS	00194752	-	10	-
CADENAS TYPE 1+ 45 mm anse haute	00080047	10	-	00988047	10	-	00288047	00293741	00292741 NS	00294741	-	10	-
CADENAS TYPE 1+ 50 mm	00080050	10	-	00988050	10	-	00188050	00193737 NS	00192737 NS	00194737	-	10	-
CADENAS TYPE 1+ 50 mm anse 1/2 haute	00080650	10	-	00988655	10	-	00188655	-	-	-	-	10	-
CADENAS TYPE 1+ 60 mm	00080060	10	-	00988060	10	-	00288060	00193753 NS	00192753 NS	00194753	-	5	-
CADENAS TYPE 1+ 60 mm anse haute	00089060	10	-	-	-	-	00288069	00293748 NS	00292748 NS	00294748	-	5	-
CADENAS TYPE 1+ 70 mm	00080070	10	-	00988070	10	-	00288070	00293749 NS	00292749 NS	00294749	-	5	-
Jeu de 2 CADENAS TYPE 1+ 30mm s'ouvrant 4 clés	-	-	-	00988032	10	-	00288032	00293743 NS	00292743 NS	00294743	-	10	-
Jeu de 3 CADENAS TYPE 1+ 30mm s'ouvrant 6 clés	-	-	-	-	-	-	00288033	00293595 NS	00292595 NS	20094595	-	10	-
Jeu de 4 CADENAS TYPE 1+ 30mm s'ouvrant 1anse inox 2 clés	-	-	-	-	-	-	00288038	00293596 NS	00292596 NS	00294596	-	10	-
Jeu de 2 CADENAS TYPE 1+ 35mm s'ouvrant 4 clés	-	-	-	-	-	-	00288034	-	-	-	-	10	-
Jeu de 3 CADENAS TYPE 1+ 35mm s'ouvrant 6 clés	-	-	-	-	-	-	00288036	00293744 NS	00292744 NS	00294744	-	5	-
Jeu de 2 CADENAS TYPE 1+ 40mm s'ouvrant 4 clés	-	-	-	00988044	10	-	00288044	00293745 NS	00292745 NS	00294745	-	10	-
Jeu de 3 CADENAS TYPE 1+ 40mm s'ouvrant 6 clés	-	-	-	-	-	-	00288046	-	-	00294594	-	5	-
Jeu de 2 CADENAS TYPE 1+ 45mm s'ouvrant 4 clés	-	-	-	-	-	-	00288048	00293746 NS	00292746 NS	00294746	-	10	-
Jeu de 3 CADENAS TYPE 1+ 45mm s'ouvrant 6 clés	-	-	-	-	-	-	00288049	-	-	-	-	5	-

NS Non stocké/Non-stored/Producto no estocado - Sur stock Europe Zone 1 et Zone 2, nous consulter pour délai d'approvisionnement - E Epuement/Stock depletion/Agotamiento del stock

Cadenas de sûreté / MACH 2

RESIST



NIVEAU DE SÉCURITÉ



GARANTIE



Acier cémenté
nickelé

Laiton



X 2

Description/Description/Descripción Corps laiton monobloc. Anse acier cémenté nickelé. Mécanisme à goupilles. 2 clés acier nickelé
Compact brass body. Hardened nickel plated steel shackle. Pin mechanism. 2 nickel plated steel keys.

Cuerpo de latón monobloque. Arco de acero cementado niquelado. Mecanismo de pasadores. 2 llaves de acero niquelado.

Finition/Finish/Acabado

Laiton poli / *Polished brass* / Latón pulido

Version/Option/Versión

Anse 1/2 haute pour taille 45 mm. Anse haute pour taille 35, 45 mm. Possibilité de personnalisation (nous consulter). Clés supplémentaires sur numéro. Cadenas sur numéro imposé et sur même combinaison. *1/2 long shackle for size 45 mm. Long shackle size 35, 45 mm. Customer's brand can be engraved (on request). Extra keys under requested number possible. Delivery of padlocks under requested number and keyed alike.*

Arco semialto para tamaño 45 mm. Arco alto para tamaños 35, 45 mm. Posibilidad de personalización (consúltenos). Llaves suplementarias sobre número. Candado con número impuesto y con la misma combinación.

Utilisation/Use/Utilización

Intérieur / *Indoor* / Interior

				ANSE 1/2 HAUTE	ANSE HAUTE	
	35mm	45mm	55mm	45mm	35mm	45mm
	35	45	55	45	35	45
	28	36	45	36	28	36
	14	14	16	14	14	14
	21,5	27	33,5	60	45	128
	18,5	25	30	25	18,5	25
	5	7	9	7	5	7
Goup.	4	5	5	5	5	5

Designation	Boite	Colis.	Prix	Sachet	Colis.	Prix	Brochable					Colis.	Prix
							France	Euro 1	Euro 2	Euro 3	Euro 4		
Cadenas MACH 2 • 35 mm anse acier 2 clés	00063351	10	-	-	-	-	00163351	-	-	-	-	10	-
Cadenas MACH 2 • 35 mm anse haute acier 2 clés	00063355	10	-	-	-	-	-	-	-	-	-	-	-
Cadenas MACH 2 • 45 mm acier 2 clés	00063451	10	-	-	-	-	00163451	-	-	-	-	10	-
Cadenas MACH 2 • 45 mm anse 1/2 haute inox 2 clés	00063453	10	-	-	-	-	00163453	-	-	-	-	10	-
Cadenas MACH 2 • 45 mm anse haute acier 2 clés	00063455	10	-	-	-	-	00263455	-	-	-	-	10	-
Cadenas MACH 2 • 55 mm acier 2 clés	00063551	10	-	-	-	-	00163551	-	-	-	-	10	-

⚠ Non stocké/Non-stored/Producto no estocado - 📦 Sur stock Europe Zone 1 et Zone 2, nous consulter pour délai d'approvisionnement - 📦 Epuisement/Stock depletion/Agotamiento del stock

Cadenas de sûreté / MACH 2 RESIST



NIVEAU DE SÉCURITÉ



GARANTIE



X 2

Description/Description/Descripción

Corps laiton monobloc. Anse laiton.
Mécanisme à goupilles. 2 clés laiton.
Compact brass body. Brass shackle. Pin mechanism. 2 brass keys.
Cuerpo de latón monobloque. Arco de latón. Mecanismo de pasadores. 2 llaves de latón.

Finition/Finish/Acabado

Laiton poli / Polished brass / Latón pulido

Version/Option/Versión

Anse 1/2 haute et haute pour taille 45 mm.
Anse haute pour taille 35 mm. Possibilité de personnalisation (nous consulter). Clés supplémentaires sur numéro. Cadenas sur numéro imposé et sur même combinaison.
1/2 long shackle and long shackle for size 45 mm. Long shackle size 35 mm. Customer's brand can be engraved (on request). Extra keys under requested number possible.
Delivery of padlocks under requested number and keyed alike.

Arco semialto y alto para tamaño 45 mm.
Arco alto para tamaño 35 mm. Posibilidad de personalización. (consúltenos). Llaves suplementarias sobre número. Candado con número impuesto y con la misma combinación.

Utilisation/Use/Utilización

Extérieur anti-corrosion
Outdoor Weather proof
Exterior Anticorrosión

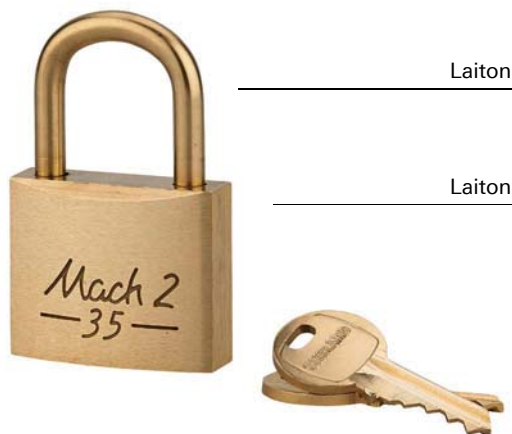

Laiton

Laiton

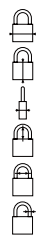

Goup.

	35 mm	45 mm	55 mm	ANSE 1/2 HAUTE		ANSE HAUTE	
				45 mm	35 mm	45 mm	
	35	45	55	45	35	45	
	28	36	45	36	28	36	
	14	14	16	14	14	14	
	21,5	27	33,5	60	45	128	
	18,5	25	30	25	18,5	25	
	5	7	9	7	5	7	
	4	5	5	5	5	5	

Designation	Boite	Colis.	Prix	Sachet	Colis.	Prix	Brochable					Colis.	Prix
							France	Euro 1	Euro 2	Euro 3	Euro 4		
Cadenas MACH 2 • 35 mm anse laiton 2 clés	00063352	10	-	-	-	-	-	-	-	-	-	-	-
Cadenas MACH 2 • 35 mm anse haute laiton 2 clés	00063356	10	-	-	-	-	-	-	-	-	-	-	-
Cadenas MACH 2 • 45 mm laiton 2 clés	00063452	10	-	-	-	-	-	-	-	-	-	-	-
Cadenas MACH 2 • 45 mm anse 1/2 haute laiton 2 clés	00063454	10	-	-	-	-	-	-	-	-	-	-	-
Cadenas MACH 2 • 45 mm anse haute laiton - 2 clés	00063456	10	-	-	-	-	-	-	-	-	-	-	-
Cadenas MACH 2 • 55 mm laiton 2 clés	00063552	10	-	-	-	-	-	-	-	-	-	-	-

Non stocké/Non-stored/Producto no estocado - Sur stock Europe Zone 1 et Zone 2, nous consulter pour délai d'approvisionnement - Epuement/Stock depletion/Agotamiento del stock

Cadenas de sûreté / SEA LINE

RESIST

Coloris différents pour ce cadenas
«anti choc» étanche avec gaine



	35 mm	40 mm
	41	48
	33,5	33,5
	22	23
	12	20,5
	13	19
	7	8
Goup.	5	5



NIVEAU DE SÉCURITÉ



GARANTIE



X 2

Description/Description/Descripción

Corps laiton gainé PVC. Anse inox gainé PVC. Double verrouillage par billes inox. Mécanisme à goupilles. 2 clés laiton nickelé.
Brass body protected by a PVC shell. Stainless shackle PVC protected. Pin mechanism. 2 nickel plated brass keys.

Cuerpo de latón con revestimiento de PVC. Arco de acero inoxidable con revestimiento de PVC. Mecanismo de pasadores. 2 llaves de latón niquelado.

Finition/Finish/Acabado

PVC - couleurs assorties

PVC - assorted colors

PVC - colores surtidos

Version/Option/Versión

Clés supplémentaires sur modèle. Sans fabrication sur numéro imposé. Cadenas sur même combinaison.

Extra keys with requested model. Without supplying under request number. Keyed alike padlocks available.

Llaves suplementarias sobre modelo. Sin fabricación con número impuesto. Candado con la misma combinación.

Utilisation/Use/Utilización

Extérieur, anti-corrosion

Outdoor, Weather proof

Exterior, Anticorrosión

Designation	Boite	Colis.	Prix	Sachet	Colis.	Prix	Brochable					Colis.	Prix
							France	Euro 1	Euro 2	Euro 3	Euro 4		
Cadenas SEA LINE 35 mm coul. assorties	00001900	10	-	00901900	20	-	00101900	00193396 NS	00192396 NS	00194396	-	10	-
Cadenas SEA LINE 35 mm noir	00001901	10	-	-	-	-	-	-	-	-	-	-	-
Cadenas SEA LINE 35 mm bleu	00001902	10	-	-	-	-	-	-	-	-	-	-	-
Cadenas SEA LINE 35 mm rouge	00001903	10	-	-	-	-	-	-	-	-	-	-	-
Cadenas SEA LINE 35 mm jaune	00001904	10	-	-	-	-	-	-	-	-	-	-	-
Cadenas SEA LINE 35 mm vert	00001905	10	-	-	-	-	-	-	-	-	-	-	-
Cadenas SEA LINE 40 mm coul. assorties	00000900	10	-	00900900	20	-	00100900	00100900 NS	00192397 NS	00194398	-	10	-
Cadenas SEA LINE 40 mm noir	00000902	10	-	-	-	-	-	-	-	-	-	-	-
Cadenas SEA LINE 40 mm bleu	00000903	10	-	-	-	-	-	-	-	-	-	-	-
Cadenas SEA LINE 40 mm rouge	00000905	10	-	-	-	-	-	-	-	-	-	-	-
Cadenas SEA LINE 40 mm jaune	00000907	10	-	-	-	-	-	-	-	-	-	-	-
Cadenas SEA LINE 40 mm vert	00000908	10	-	-	-	-	-	-	-	-	-	-	-
Jeu de 2 cadenas SEA LINE 40 mm s'entrouvrant étanche 4 clés	-	-	-	-	-	-	00200900	-	-	00294727	-	10	-

NS Non stocké/Non-stored/Producto no estocado - ☐ Sur stock Europe Zone 1 et Zone 2, nous consulter pour délai d'approvisionnement - E Epuisement/Stock depletion/Agotamiento del stock

Cadenas de sûreté / BUMPER RESIST



NIVEAU DE SÉCURITÉ



GARANTIE



Acier cémenté
gainé PVC

Acier zingué
gainé PVC



Description/Description/Descripción

Corps à lamelles acier zingué gainé PVC. Anse acier cémenté gainée PVC. Double verrouillage par billes inox. Mécanisme à goupilles. 2 clés laiton nickelé gainé PVC. *Laminated zinc plated steel body protected by PVC shell. Hardened steel shackle PVC protected. Double stainless steel ball locking. Pin mechanism. 2 nickel plated brass keys.* Cuerpo de láminas de acero cincado con revestimiento de PVC. Arco de acero cementado con revestimiento de PVC. Doble cierre por bolas de acero inoxidable. Mecanismo de pasadores. 2 llaves de latón niquelado.

Finition/Finish/Acabado

PVC - couleurs assorties

PVC - assorted colors

PVC - colores surtidos

Version/Option/Versión

Clés supplémentaires sur modèle. Sans fabrication sur numéro imposé. Cadenas sur même combinaison.

Extra keys with requested model. Without supplying under request number. Keyed alike padlocks available.

Llaves suplementarias sobre modelo. Sin fabricación con número impuesto. Candado con la misma combinación.

Utilisation/Use/Utilización

Extérieur / *Outdoor* / Exterior



X 2



	45mm	54mm
	49	60
	41,5	44
	31	36
	16,5	21,5
	18	22
	8,5	11
Goup	5	5

Designation	Boite	Colis.	Prix	Sachet	Colis.	Prix	Brochable					Colis.	Prix
							France	Euro 1	Euro 2	Euro 3	Euro 4		
Cadenas BUMPER 45 mm couleurs assorties	00002802	10	-	00902802	10	-	00202802	00293990	00292990	00294990	-	6	-
Cadenas BUMPER 45 mm noir	00002812	10	-	-	-	-	-	-	-	-	-	-	-
Cadenas BUMPER 45 mm bleu	00002822	10	-	-	-	-	-	-	-	-	-	-	-
Cadenas BUMPER 45 mm rouge	00002832	10	-	-	-	-	-	-	-	-	-	-	-
Cadenas BUMPER 45 mm jaune	00002842	10	-	-	-	-	-	-	-	-	-	-	-
Cadenas BUMPER 45 mm vert	00002852	10	-	-	-	-	-	-	-	-	-	-	-
Cadenas BUMPER 54 mm couleurs assorties	00002803	10	-	00902803	10	-	00202803	00293398	00292398	00294398	-	6	-
Cadenas BUMPER 54 mm noir	00002813	10	-	-	-	-	-	-	-	-	-	-	-
Cadenas BUMPER 54 mm bleu	00002823	10	-	-	-	-	-	-	-	-	-	-	-
Cadenas BUMPER 54 mm rouge	00002833	10	-	-	-	-	-	-	-	-	-	-	-
Cadenas BUMPER 54 mm jaune	00002843	10	-	-	-	-	-	-	-	-	-	-	-
Cadenas BUMPER 54 mm vert	00002853	10	-	-	-	-	-	-	-	-	-	-	-

Non stocké/Non-stored/Producto no estocado - Sur stock Europe Zone 1 et Zone 2, nous consulter pour délai d'approvisionnement - Epuement/Stock depletion/Agotamiento del stock

Cadenas de sûreté / ASTRA

RESIST



NIVEAU DE SÉCURITÉ



GARANTIE

Avec son anse intégrée ce cadenas est idéalement conçu pour les chaînes.



X 2



Description/Description/Descripción

Corps inox. Anse inox. Mécanisme à goupilles.
2 clés laiton nickelé.

Stainless steel case. Stainless steel shackle. Pin mechanism. 2 nickel plated brass keys.

Cuerpo de acero inoxidable. Arco de acero inoxidable.
Mecanismo de pasadores. 2 llaves de latón niquelada.

Finition/Finish/Acabado

Inox

Stainless steel

Acero inoxidable

Versión/Option/Versión

Clés supplémentaires sur modèle. Sans fabrication sur numéro imposé. Cadenas sur même combinaison.

Extra keys with requested model without supplying under requested number. Keyed alike padlocks available.

Arco de acero inoxidable. Llaves suplementarias sobre modelo sin fabricación con número impuesto.

Utilisation/Use/Utilización

Extérieur

Outdoor

Exterior

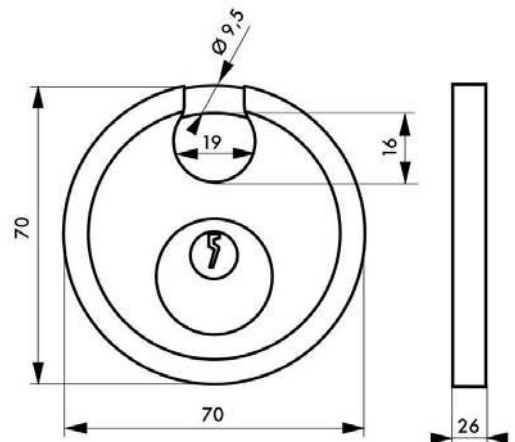

Designation	Boite	Colis.	Prix	Sachet	Colis.	Prix	Brochable					Colis.	Prix
							France	Euro 1	Euro 2	Euro 3	Euro 4		
cadenas ASTRA 70 mm anse inox	00096700	10	-	00996700	10	-	00196700	00193056 NS	00192056 NS	00194056	-	10	-

NS Non stocké/Non-stored/Producto no estocado - ☐ Sur stock Europe Zone 1 et Zone 2, nous consulter pour délai d'approvisionnement - E Epuisement/Stock depletion/Agotamiento del stock

Cadenas de sûreté / CINOX RESIST



NIVEAU DE SÉCURITÉ



GARANTIE



X 3



Description/Description/Descripción

Corps Inox et anse inox 304. Double verrouillage par la clé. Mécanisme à disques. 3 clés.

Stainless steel body and stainless 304 shackle. Double locking with beads. Discs mechanism. 3 keys.

Cuerpo de acero inoxidable y arco de acero inoxidable 304. Doble bloqueo con llave. Mecanismo de discos. 3 llaves.

Finition/Finish/Acabado

Inox poli

Polished stainless steel

Acero inoxidable pulido

Version/Option/Versión

Clés supplémentaires sur modèle.

Extra keys with requested model.

Llaves suplementarias sobre modelo.

Utilisation/Use/Utilización

Extérieur, anti-corrosion

Outdoor, Weather proof

Exterior, Anticorrosión

	30 mm	40 mm	50 mm	60 mm
	30	40	50	60
	26	32	38	42
	16	20	20	20
	22	28	27	29
	15	20	23	26
	5	7	8,5	12
Disq.	4	4	4	4

Designation	Boite	Colis.	Prix	Sachet	Colis.	Prix	Brochable					Colis.	Prix
							France	Euro 1	Euro 2	Euro 3	Euro 4		
Cadenas Cinox 30 mm	-	-	-	00987030	10	-	00187030	00193820 NS	00192820 NS	00194820	-	10	-
Cadenas Cinox 40 mm	-	-	-	00987040	10	-	00187040	00193821 NS	00192821 NS	00194821	-	10	-
Cadenas Cinox 50 mm	-	-	-	00987050	10	-	00187050	00193822 NS	00192822 NS	00194822	-	10	-
Cadenas Cinox 60 mm	-	-	-	00987060	5	-	00187060	00193823 NS	00192823 NS	00194823	-	10	-

NS Non stocké/Non-stored/Producto no estocado - Sur stock Europe Zone 1 et Zone 2, nous consulter pour délai d'approvisionnement - E Epuisement/Stock depletion/Agotamiento del stock

Cadenas de sûreté / RINOX RESIST



NIVEAU DE SÉCURITÉ



GARANTIE



X 4



Inox

Inox



Description/Description/Descripción

Corps inox. Anse inox. Mécanisme à goupilles. Double verrouillage par billes. Trou d'écoulement d'eau. 4 clés réversibles.

Stainless steel body. Stainless steel shackle. Pins mechanism. Double ball locking. Flow through water hole. 4 reversible keys. Cuerpo de acero

Cuerpo de acero inoxidable. Arco de acero inoxidable. Mecanismo de pasadores. Doble bloqueo con bolas. Orificio de circulación de agua. 4 llaves reversibles.

Finition/Finish/Acabado

Inox brossé

Polished stainless steel

Acero inoxidable cepillado.

Utilisation/Use/Utilización

Extérieur.

Outdoor use.

Sitio de construcción.

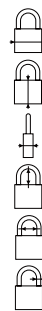

Goup.

	30 mm	40 mm	50 mm	60 mm	70 mm
	30	40	50	60	70
	32	40	43	46	49
	20	20	20	20	20
	20	24	29	35	36
	17	19	23	27	35
	5	7	9,5	10,5	11,5
Goup.	5	5	5	5	5

Designation	Boite	Colis.	Prix	Sachet	Colis.	Prix	Brochable					Colis.	Prix
							France	Euro 1	Euro 2	Euro 3	Euro 4		
Cadenas RINOX 30mm anse inox 4 clés	-	-	-	00990063	10	-	00190063	00193623 NS	00192623 NS	001946233	-	10	-
Cadenas RINOX 40mm anse inox 4 clés	-	-	-	00990064	10	-	00190064	00193624 NS	00192624 NS	00194624	-	10	-
Cadenas RINOX 50mm anse inox 4 clés	-	-	-	00990065	10	-	00190065	00193625 NS	00192625 NS	00194625	-	5	-
Cadenas RINOX 60mm anse inox 4 clés	-	-	-	00990066	10	-	00290066	00293645 NS	00292645 NS	00294645	-	5	-
Cadenas RINOX 70mm anse inox 4 clés	-	-	-	00990067	5	-	00290067	00293646 NS	00292646 NS	00294646	-	5	-

NS Non stocké/Non-stored/Producto no estocado - M Sur stock Europe Zone 1 et Zone 2, nous consulter pour délai d'approvisionnement - E Epuisement/Stock depletion/Agotamiento del stock

Cadenas de sûreté / OCTO RESIST



NIVEAU DE SÉCURITÉ



GARANTIE



X 3

Description/Description/Descripción

Corps acier. Anse acier cémenté nickelé. Mécanisme à goupilles. Double verrouillage par billes. Trou d'écoulement d'eau. 3 clés réversibles.

Steel body. Case-hardened nickel plated steel shackle. Pins mechanism. Double ball locking. Flow through water hole. 3 reversible keys.

Cuerpo de acero. Arco de acero cementado níquelado. Mecanismo de pasadores. Doble bloqueo con bolas. Orificio de circulación de agua. 3 llaves reversibles.

Finition/Finish/Acabado

Chromé satiné.

Satin chrome

Cromado satina.

Utilisation/Use/Utilización

Chantier.

Construction site.

Sitio de construcción.



Acier cémenté
nickelé



Acier



	40 mm	50 mm	60 mm	70 mm
	40	50	60	70
	32	38	42	45
	22	22	22	22
	21	24	29	34
	19	23	29	34
	7	9,5	10,5	11
Goup.	5	5	5	5

Designation	Boite	Colis.	Prix	Sachet	Colis.	Prix	Brochable					Colis.	Prix
							France	Euro 1	Euro 2	Euro 3	Euro 4		
Cadenas OCTO 40mm anse acier 3 clés	-	-	-	00990052	10	-	00190052	00193620 NS	00192620 NS	00194620	-	10	-
Cadenas OCTO 50mm anse acier 3 clés	-	-	-	00990053	10	-	00190053	00193621 NS	00192621 NS	00194621	-	5	-
Cadenas OCTO 60mm anse acier 3 clés	-	-	-	00990054	10	-	00290054	00293640 NS	00292640 NS	00294640	-	5	-
Cadenas OCTO 70mm anse acier 3 clés	-	-	-	00990055	10	-	00290055	00293641 NS	00292641 NS	00294641	-	5	-

NS Non stocké/Non-stored/Producto no estocado - Sur stock Europe Zone 1 et Zone 2, nous consulter pour délai d'approvisionnement - E Epuisement/Stock depletion/Agotamiento del stock

Cadenas de sûreté / OCTO-P RESIST



NIVEAU DE SÉCURITÉ



GARANTIE



X 3



Acier cémenté
nickelé

Acier



Description/Description/Descripción

Corps acier. Anse acier cémenté nickelé. Mécanisme à goupilles. Double verrouillage par billes. Trou d'écoulement d'eau. 3 clés réversibles.

Steel body. Case-hardened nickel plated steel shackle.

Pins mechanism. Double ball locking. Flow through water hole. 3 reversible keys.

Cuerpo de acero. Arco de acero cementado niquelado.

Mecanismo de pasadores. Doble bloqueo con bolas. Orificio de circulación de agua. 3 llaves reversibles.

Finition/Finish/Acabado

Chromé satiné.

Satin chrome

Cromado satina.

Utilisation/Use/Utilización

Chantier.

Construction site.

Sitio de construcción.

	40 mm	50 mm	60 mm	70 mm
	40	50	60	70
	53	63	73	83
	22	22	22	22
	24	29	34	38
	20	22	27	37
	7	9,5	10,5	11
Goup.	5	5	5	5

Designation	Boite	Colis.	Prix	Sachet	Colis.	Prix	Brochable					Colis.	Prix
							France	Euro 1	Euro 2	Euro 3	Euro 4		
Cadenas OCTO-P 40mm anse protégée acier 3 clés	-	-	-	00990056	10	-	00190056	00193622	00192622	00194622	-	10	-
Cadenas OCTO-P 50mm anse protégée acier 3 clés	-	-	-	00990057	5	-	00290057	00293642	00292642	00294642	-	5	-
Cadenas OCTO-P 60mm anse protégée acier 3 clés	-	-	-	00990058	10	-	00290058	00293643	00292643	00294643	-	5	-
Cadenas OCTO-P 70mm anse protégée acier 3 clés	-	-	-	00990059	10	-	00290059	00293644	00292644	00294644	-	5	-

Non stocké/Non-stored/Producto no estocado - Sur stock Europe Zone 1 et Zone 2, nous consulter pour délai d'approvisionnement - Epuisement/Stock depletion/Agotamiento del stock

Cadenas de sûreté / REVERSO RESIST



NIVEAU DE SÉCURITÉ



GARANTIE



X 4



Acier cémenté
nickelé

Laiton



Clés réversibles pour une plus grande facilité d'utilisation.

Description/Description/Descripción

Corps laiton monobloc. Anse acier cémenté nickelé. Mécanisme à goupilles. Double ancrage. Joint d'étanchéité. Trou d'écoulement d'eau. 4 clés acier nickelé réversibles gainées PVC.

Compact brass body. Hardened nickel plated steel shackle. Pin mechanism. Double locking. Shackle grommet. Flow through water hole. 4 reversible nickel plated brass keys with head protected by a PVC shell.

Cuerpo de latón monobloque. Arco de acero cementado niquelado. Mecanismo de pasadores. Doble anclaje mediante pestillos. Junta de estanqueidad. Orificio de circulación de agua. 4 llaves planas de acero niquelado.

Finition/Finish/Acabado

Laiton poli

Polished brass

Latón pulido

Utilisation/Use/Utilización

Extérieur

Outdoor

Exterior

	30 mm	40 mm	50 mm
	32	40	50
	29	32	43
	14	15	16
	23,5	32,5	39,5
	16,3	22,5	24,5
	5	6	9
Goup.	5	5	5

Designation	Boîte	Colis.	Prix	Sachet	Colis.	Prix	Brochable					Colis.	Prix
							France	Euro 1	Euro 2	Euro 3	Euro 4		
Cadenas REVERSO 30 mm 4 clés réversibles	-	-	-	00961030	10	-	00161030	00193297 NS	00192297 NS	00194297	-	10	-
Cadenas REVERSO 40 mm 4 clés réversibles	-	-	-	00961040	10	-	00161040	00193298 NS	00192298 NS	00194298	-	10	-
Cadenas REVERSO 50 mm 4 clés réversibles	-	-	-	00961050	10	-	00161050	00193299 NS	00192299 NS	00194299	-	10	-

NS Non stocké/Non-stored/Producto no estocado - Sur stock Europe Zone 1 et Zone 2, nous consulter pour délai d'approvisionnement - Epuisement/Stock depletion/Agotamiento del stock

Cadenas de sûreté / QUADRA

RESIST



NIVEAU DE SÉCURITÉ



GARANTIE



X 4



Description/Description/Descripción

Corps acier nickelé satin. Anse acier cémenté nickelé.
Mécanisme à goupilles. Double verrouillage par billes.
Rotor laiton. 4 clés réversibles.

Satin nickel-plated steel body. Case-hardened nickel-plated steel shackle. Pins mechanism. Double locking with beads. Brass rotor. 4 reversible keys.

Cuerpo de acero niquelado satén. Arco de acero cementado niquelado. Mecanismo de pasadores. Doble bloqueo con bolas. Rotor de latón. 4 llaves reversibles.

Finition/Finish/Acabado

Nickel satin

Nickel satin

Níquel satinado

Utilisation/Use/Utilización

Chantier

Nickel satin

Níquel satinado

Anse protégée

	50 mm	60 mm	50 mm	60 mm
	50	60	50	60
	40	42	60	70
	20	20	20	20
	30	33	20	28
	24	22,5	23	27
	8,5	10,5	8,5	9,5
Goup.	6	6	6	6

Designation	Boite	Colis.	Prix	Sachet	Colis.	Prix	Brochable					Colis.	Prix
							France	Euro 1	Euro 2	Euro 3	Euro 4		
Cadenas QUADRA 50 mm	00095520	10	-	00995520	10	-	00295520	00293813 NS	00292813 NS	00294813	-	10	-
Cadenas QUADRA 60 mm	00095521	10	-	00995521	5	-	00295521	00293814 NS	00292814 NS	00294814	-	10	-
Cad. QUADRA anse protégée 50 mm	00095522	10	-	00995522	10	-	00295522	00293815 NS	00292815 NS	00294815	-	10	-
Cad. QUADRA anse protégée 60 mm	00095523	10	-	00995523	10	-	00295523	00293816 NS	00292816 NS	00294816	-	10	-

NS Non stocké/Non-stored/Producto no estocado - ☐ Sur stock Europe Zone 1 et Zone 2, nous consulter pour délai d'approvisionnement - ☒ Epuisement/Stock depletion/Agotamiento del stock

Cadenas de sûreté / Mach 3 RESIST



NIVEAU DE SÉCURITÉ



GARANTIE



Inox

Laiton

Description/Description/Descripción

Corps laiton monobloc. Anse acier inoxydable. Mécanisme à goupilles. Double ancrage par pènes. Joint d'étanchéité. Trou d'écoulement d'eau. 3 clés acier nickelé.

Compact brass body. Stainless steel shackle. Pin mechanism. Double bolt locking. Shackle grommet. Flow through water hole. 3 nickel plated steel keys.

Cuerpo de latón monobloque. Arco de acero inoxidable. Mecanismo de pasadores. Doble anclaje mediante pestillos. Junta de estanqueidad. Orificio de circulación de agua. 3 llaves de acero niquelado.

Finition/Finish/Acabado

Laiton poli / Polished brass / Latón pulido

Version/Option/Versión

Anse 1/2 haute et haute pour taille 40 mm. Possibilité de clés supplémentaires sur numéro. Cadenas sur numéro imposé et sur même combinaison. Possibilité d'organigramme compatible avec système HG5 (à partir du 40mm).

1/2 long shackle and long. shackle for size 40 mm. xtra keys under requested number. Padlocks possible under requested number. Master keyed system available HG5 (from 40mm). 2 or 3 keys.

Arco semi alti y alto para tamaño 40 mm. Posibilidad de llaves suplementarias sobre número. Candado con número impuesto y con la misma combinación. Posibilidad de organigrama (desde 40mm). 2 or 3 llaves.

Utilisation/Use/Utilización

Extérieur / Outdoor / Exterior



X 3



Designation	Boite	Colis.	Prix	Sachet	Colis.	Prix	Brochable					Colis.	Prix
							France	Euro 1	Euro 2	Euro 3	Euro 4		
Cadenas MACH 3 • 30 mm anse inox 2 clés	00094301	10	-	-	-	-	00194301	-	-	-	-	10	-
Cadenas MACH 3 • 35 mm anse inox 2 clés	00094351	10	-	00994351	20	-	00194351	-	-	-	-	10	-
Cadenas MACH 3 • 40 mm anse inox 2 clés	00094401	10	-	00994401	20	-	00194401	00193540	-	-	-	10	-
Cadenas MACH 3 • 40 mm anse 1/2 haute inox 2 clés	00094403	10	-	00994403	20	-	00194403	-	-	-	-	10	-
Cadenas MACH 3 • 40 mm anse haute inox 2 clés	00094402	10	-	00994402	20	-	00294402	00293573	-	00294573	-	10	-
Cadenas MACH 3 • 45 mm anse inox 2 clés	00094451	10	-	00994451	20	-	00194451	00193541	-	-	-	10	-
Cadenas MACH 3 • 50 mm anse inox 2 clés	00094501	10	-	00994501	20	-	00194501	00193542	-	-	-	10	-
Cadenas MACH 3 • 55 mm anse inox 2 clés	00094551	10	-	-	-	-	00194551	-	-	-	-	10	-

⚠ Non stocké/Non-stored/Producto no estocado - 📦 Sur stock Europe Zone 1 et Zone 2, nous consulter pour délai d'approvisionnement - 📦 Epuisement/Stock depletion/Agotamiento del stock

Cadenas de sûreté / Mach 3

RESIST



NIVEAU DE SÉCURITÉ



GARANTIE



Designation	Boite	Colis.	Prix	Sachet	Colis.	Prix	Brochable					Colis.	Prix
							France	Euro 1	Euro 2	Euro 3	Euro 4		
Jeu de 2 cadenas MACH 3 • 35 mm s'ouvrant 4 clés	-	-	-	-	-	-	00183352	-	-	-	-	10	-
Jeu de 2 cadenas MACH 3 • 45 mm s'ouvrant 4 clés	-	-	-	-	-	-	00183452	-	-	-	-	10	-
Jeu de 3 cadenas MACH 3 • 35 mm s'ouvrant 6 clés	-	-	-	-	-	-	00283351	-	-	-	-	5	-
Jeu de 3 cadenas MACH 3 • 45 mm s'ouvrant 6 clés	-	-	-	-	-	-	00283451	-	-	-	-	5	-
MACH 3 • 60 mm	00094601	10	-	-	-	-	00194601	-	-	-	-	10	-

	30 mm	35 mm	40 mm	45 mm	50 mm	55 mm	60 mm	ANSE 1/2 HAUTE	ANSE HAUTE
	30	35	40	45	50	55	60	40 mm	40 mm
	30	35	40	45	50	55	60	40	40
	29	29	39	39	42	45	48	39	39
	14	14	16	16	16	16	20	16	16
	15	25	22	25	29	32	34	60	128
	15	18,5	22	25	29	31	34	22	22
	5	5	6	7	8	9	10	6	6
Goup.	4	4	5	5	5	5	5	5	5

Cadenas de sûreté / MACH 3 BUMPER RESIST



NIVEAU DE SÉCURITÉ



GARANTIE



X 3



Inox

Laiton



Protection renforcée par bumper PVC contre les poussières (sable ...) et les intempéries



Description/Description/Descripción

Corps laiton monobloc. Anse acier inoxydable. Mécanisme à goupilles. Double ancrage par pènes. Joint d'étanchéité. Bumper PVC. Trou d'écoulement d'eau. 3 clés acier nickelé.
Compact brass body. Stainless steel shackle. Pin mechanism. Double bolt locking. Shackle grommet. PVC bumper. Flow through water hole. 3 nickel plated steel keys.

Cuerpo de latón monobloque. Arco de acero inoxidable. Mecanismo de pasadores. Doble anclaje mediante pestillos. Junta de estanqueidad. Bumper de PVC. Ori cio de circulación de agua. 3 llaves de acero niquelado.

Finition/Finish/Acabado

Laiton poli

Polished brass

Latón pulido

Versión/Option/Versión

Anse 1/2 haute et haute pour taille 40 mm. Possibilité de clés supplémentaires sur numéro. Cadenas sur numéro imposé et sur même combinaison. Possibilité d'organigramme compatible avec système HG5 (à partir du 40mm).

1/2 long shackle and long shackle for size 40 mm. Extra keys under requested number. Padlocks possible under requested number. Master keyed system available HG5 (40mm) 2 or 3 keys.

Arco semi alti y alto para tamaño 40 mm. Posibilidad de llaves suplementarias sobre número. Candado con número impuesto y con la misma combinación. Posibilidad de organigrama. 2 or 3 llaves.

Utilisation/Use/Utilización

Extérieur

Outdoor

Exterior

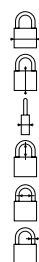

Goup

	40 mm	40 mm	40 mm
	40	40	40
	39	39	39
	16	16	16
	22	60	128
	22	22	22
	6	6	6
Goup	5	5	5

Designation	Boite	Colis.	Prix	Sachet	Colis.	Prix	Brochable					Colis.	Prix
							France	Euro 1	Euro 2	Euro 3	Euro 4		
Cadenas MACH 3 BUMPER 40 mm	00094406	10	-	-	-	-	00194406	-	-	00194332	-	10	-
Cadenas MACH 3 BUMPER 40 mm anse 1/2 haute	00094407	10	-	-	-	-	-	-	-	-	-	-	-
Cadenas MACH 3 BUMPER 40 mm anse haute	00094412	10	-	-	-	-	-	-	-	-	-	-	-

Non stocké/Non-stored/Producto no estocado - Sur stock Europe Zone 1 et Zone 2, nous consulter pour délai d'approvisionnement - Epuisement/Stock depletion/Agotamiento del stock

Cadenas de sûreté / MACH 3 AP RESIST



NIVEAU DE SÉCURITÉ



GARANTIE



Description/Description/Descripción

Corps laiton monobloc. Anse acier inoxydable. Mécanisme à goupilles. Double ancrage par billes. Trou d'écoulement d'eau. 3 clés acier nickelé

Compact brass body. Stainless steel shackle. Pin mechanism. Double bolt locking. Flow through water hole. 3 nickel plated steel keys.

Cuerpo de latón monobloque. Arco de acero inoxidable. Mecanismo de pasadores. Doble anclaje mediante pestillos. Junta de estanqueidad. Orificio de circulación de agua. 3 llaves de acero niquelado.

Finition/Finish/Acabado

Laiton poli

Polished brass

Latón pulido

Version/Option/Versión

Bumper PVC. Possibilité de clés supplémentaires sur numéro. Cadenas sur numéro imposé et sur même combinaison. Possibilité d'organigramme compatible avec système HG5.

PVC bumper. Extra keys and extra padlocks possible under requested number. Master keyed system available HG5. 2 or 3 keys.

Bumper de PVC. Arco semi alti y alto para tamaño 40 mm. Posibilidad de llaves suplementarias sobre número. Candado con número impuesto y con la misma combinación. Posibilidad de organigrama. 2 or 3 llaves.

Utilisation/Use/Utilización

Extérieur

Outdoor

Exterior



X 3

	avec bumper	
	094020	094021
	40	44
	51	51
	16	20
	16,5	16,5
	18	18
	6	6
Goup	5	5

Designation	Boite	Colis.	Prix	Sachet	Colis.	Prix	Brochable					Colis.	Prix
							France	Euro 1	Euro 2	Euro 3	Euro 4		
Cadenas MACH 3 AP 40 mm	00094020	10	-	-	-	-	-	-	-	-	-	-	-
Cadenas MACH 3 AP 40 mm avec bumper	00094021	10	-	-	-	-	-	-	-	-	-	-	-

⚠ Non stocké/Non-stored/Producto no estocado - 📦 Sur stock Europe Zone 1 et Zone 2, nous consulter pour délai d'approvisionnement - 📦 Epuisement/Stock depletion/Agotamiento del stock

Cadenas de sûreté / ADRIATIC RESIST



NIVEAU DE SÉCURITÉ



GARANTIE

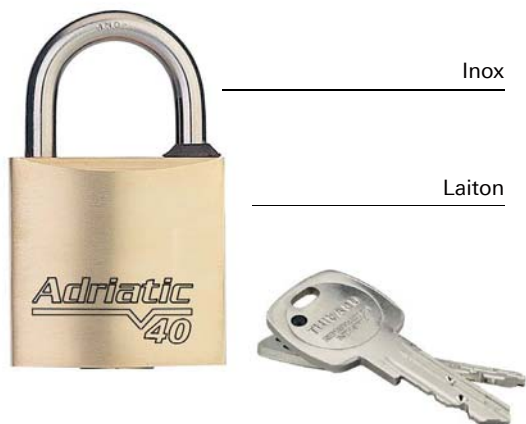

Inox

Laiton



Cadenas à clés brevetées idéal pour organigramme et usage industriel.

Description/Description/Descripción

Corps laiton monobloc. Anse acier inoxydable. Mécanisme à goupilles. Double verrouillage par pènes. Joint d'étanchéité. Trou d'écoulement d'eau. 2 clés laiton nickelé avec insert ABS et carte de propriété permettant la reproduction des clés en usine.
Compact brass body. Stainless steel shackle. Pin mechanism. Double bolt locking. Shackle grommet. Flow through water hole. 2 nickel plated brass keys with personal security card for key copies.
 Cuerpo de latón monobloque. Arco de acero inoxidable. Mecanismo de pasadores. Doble cierre mediante pestillos. Junta de estanqueidad. Orificio de circulación de agua. 2 llaves de latón niquelado con título de propiedad que permite la reproducción de las llaves en la fábrica.

Finition/Finish/Acabado

Laiton poli
Polished brass
 Latón pulido

Version/Option/Versión

Possibilité de clés supplémentaires sur numéro.. Possibilité de cadenas sur numéro imposé et sur même combinaison. Possibilité d'organigramme compatible avec système Adriatic.
Extra keys and extra padlocks possible under requested number. Master key system Adriatic.

Possibilité de llaves suplementarias sobre número. Candado con número impuesto y con la misma combinación. Posibilidad de organigrama compatible con el sistema Adriatic.

Utilisation/Use/Utilización

Industrie
Industry
 Industria



X 2



Goup.

	049400	049600	049402
40	40	60	40
39	39	48	39
16	16	20	16
22	22	34	60
22	22	34	22
6	6	10	6
Goup.	6	6	6

Designation	Boite	Colis.	Prix	Sachet	Colis.	Prix	Brochable					Colis.	Prix
							France	Euro 1	Euro 2	Euro 3	Euro 4		
Cadenas ADRIATIC • 40 mm	00049400	10	-	00949400	10	-	-	-	-	-	-	-	-
Cadenas ADRIATIC • 40 mm anse 1/2 haute	00049402	10	-	00949402	10	-	-	-	-	-	-	-	-
Cadenas ADRIATIC • 60 mm	00049600 NS	10	-	00949600	10	-	-	-	-	-	-	-	-

NS Non stocké/Non-stored/Producto no estocado - Sur stock Europe Zone 1 et Zone 2, nous consulter pour délai d'approvisionnement - E Epuisement/Stock depletion/Agotamiento del stock

Cadenas de sûreté / NAUTIC RESIST



NIVEAU DE SÛRETÉ



GARANTIE



Acier cémenté
nickelé

Laiton

Description/Description/Descripción

Corps laiton monobloc. Anse acier cémenté nickelé. Mécanisme à goupilles. 3 clés laiton.

Compact brass body. Hardened nickel plated steel shackle. Pin mechanism. 3 brass keys.

Cuerpo de latón monobloque. Arco de acero cementado niquelado. Mecanismo de pasadores. 3 llaves de latón.

Finition/Finish/Acabado

Laiton poli

Polished brass

Latón pulido

Version/Option/Versión

55 mm HG pour organigramme. Clés supplémentaires sur numéro. Clé prisonnière en option pour 45 - 55 mm (Le cadenas doit être fermé pour reprendre la clé). Cadenas sur numéro imposé et sur même combinaison.

55 mm HG for master keyed alike. Extra keys under requested number possible.

Captive key (the padlock must be closed to remove the key). Delivery of padlocks under requested number and keyed alike.

55 mm HG para organigrama. Llaves suplementarias sobre número. (el candado debe estar cerrado para retirar la llave). Candado con número impuesto y con la misma combinación.

Utilisation/Use/Utilización

Intérieur

Indoor

Interior



X 3

	35mm	45mm	55mm	65mm
	35	45	55	65
	25	25	32	32
	17	17	23,5	23,5
	20	29	33	43
	19	26	32	40
	5	6	8	9
Goup.	4	4	5	5

Designation	Boite	Colis.	Prix	Sachet	Colis.	Prix	Brochable					Colis.	Prix
							France	Euro 1	Euro 2	Euro 3	Euro 4		
Cadenas NAUTIC 35 mm	00068351	10	-	00968351	10	-	-	-	-	-	-	-	-
Cadenas NAUTIC 45 mm	00068451	10	-	00968451	10	-	00168451	00193445 NS	00192445 NS	00194445 NS	-	10	-
Cadenas NAUTIC 55 mm	00068551	10	-	00968551	10	-	00168551	00193446 NS	00192446 NS	00194446 NS	-	10	-
Cadenas NAUTIC HG 55 mm	00068553	10	-	00968553	10	-	-	-	-	-	-	-	-
Cadenas NAUTIC 65 mm	00068651	10	-	00968651	5	-	00168651	-	-	-	-	10	-
Cadenas NAUTIC 80 mm	00068801	10	-	00968801	5	-	00268801	-	-	-	-	10	-

NS Non stocké/Non-stored/Producto no estocado - S Sur stock Europe Zone 1 et Zone 2, nous consulter pour délai d'approvisionnement - E Epuisement/Stock depletion/Agotamiento del stock

Cadenas de sûreté / NAUTIC RESIST



NIVEAU DE SÉCURITÉ



GARANTIE



Laiton

Laiton



Description/Description/Descripción

Corps laiton monobloc. Anse laiton.
Mécanisme à goupilles. 3 clés laiton.
Compact brass body. Brass shackle. Pin mechanism. 3 brass keys.

Cuerpo de latón monobloque. Arco de latón. Mecanismo de pasadores. 3 llaves de latón.

Finition/Finish/Acabado

Laiton poli / Polished brass / Latón pulido

Version/Option/Versión

55 mm HG pour organigramme. Clés supplémentaires sur numéro. Clé prisonnière en option pour 45 - 55 mm. (Le cadenas doit être fermé pour reprendre la clé). Cadenas sur numéro imposé et sur même combinaison.

55 mm HG for master keyed alike. Extra keys under requested number possible. (the padlock must be closed to remove the key). Delivery of padlocks under requested number and keyed alike.

55 mm HG para organigrama. Llaves suplementarias sobre número. (el candado debe estar cerrado para retirar la llave). Candado con número impuesto y con la misma combinación.

Utilisation/Use/Utilización

Extérieur, anti-corrosion

Outdoor, Weather proof

Exterior, Anticorrosión



X 3



Goup.

	ANSE HAUTE					
	35mm	45mm	55mm	65mm	45mm	55mm
	35	45	55	65	45	55
	25	25	32	32	25	32
	17	17	23,5	23,5	17	23,5
	20	29	33	43	150	148
	19	26	32	40	26	32
	5	6	8	9	6	8
	4	4	5	5	5	5

Designation	Boite	Colis.	Prix	Sachet	Colis.	Prix	Brochable					Colis.	Prix
							France	Euro 1	Euro 2	Euro 3	Euro 4		
Cadenas NAUTIC 35 mm	00068352	10	-	-	-	-	-	-	-	-	-	-	-
Cadenas NAUTIC 45 mm	00068452	10	-	-	-	-	00168452	-	-	-	-	10	-
Cadenas NAUTIC 45 mm anse haute	00068456	10	-	-	-	-	-	-	-	-	-	-	-
Cadenas NAUTIC 55 mm	00068552	10	-	00968552	20	-	00168552	-	-	00194996	-	10	-
Cadenas NAUTIC HG 55 mm	00068554	10	-	-	-	-	-	-	-	-	-	-	-
Cadenas NAUTIC 55 mm anse haute	00068556	10	-	-	-	-	-	-	-	-	-	-	-
Cadenas NAUTIC 65 mm	00068652	10	-	-	-	-	00168652	-	-	-	-	10	-
Cadenas NAUTIC 68 mm	00068802	10	-	-	-	-	-	-	-	-	-	-	-

⚠ Non stocké/Non-stored/Producto no estocado - 📍 Sur stock Europe Zone 1 et Zone 2, nous consulter pour délai d'approvisionnement - 📦 Epuisement/Stock depletion/Agotamiento del stock

Cadenas de sûreté / NAUTIC RESIST



NIVEAU DE SÉCURITÉ



GARANTIE



X 3



Acier cémenté
nickelé gainé

Description/Description/Descripción

Corps laiton monobloc. Anse acier cémenté nickelé gainé. Mécanisme à goupilles. 3 clés laiton.
Compact brass body. Hardened nickel plated steel shackle protected by a PVC. Pin mechanism. 3 brass keys.

Cuerpo de latón monobloque. Arco de acero cementado niquelado con revestimiento de PVC. Mecanismo de pasadores. 3 llaves de latón.

Finition/Finish/Acabado

Laiton poli
Polished brass
Latón pulido

Utilisation/Use/Utilización

Chantier
Construction sites
Obras de construcción

Corps laiton

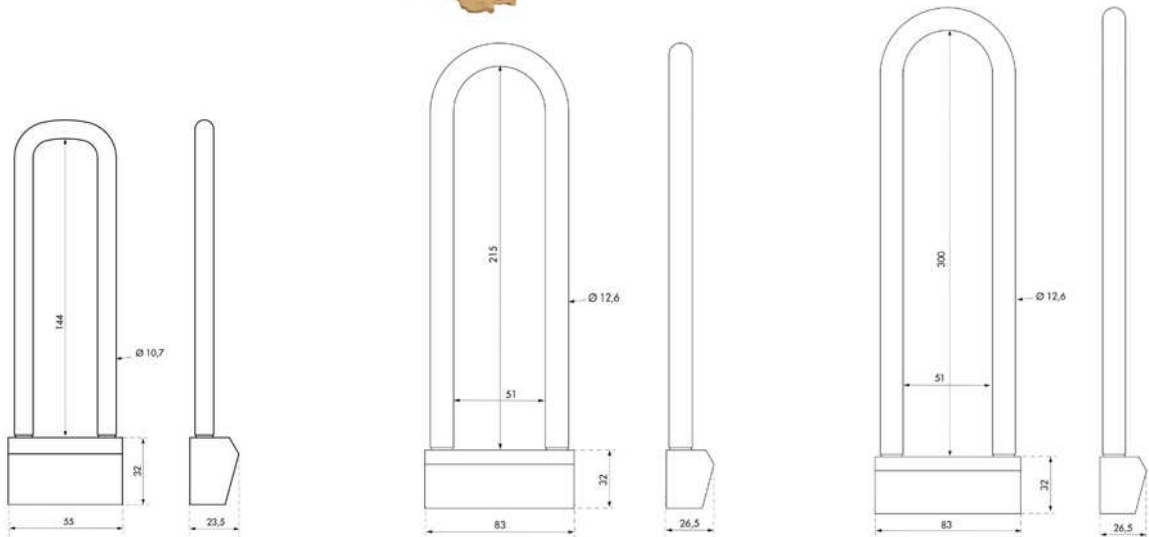

Designation	Boite	Colis.	Prix	Sachet	Colis.	Prix	Brochable					Colis.	Prix
							France	Euro 1	Euro 2	Euro 3	Euro 4		
Cadenas NAUTIC 55mm anse haute 145 acier gainée - 3 clés	00068557	10	-	-	-	-	-	-	-	-	-	-	-
Cadenas NAUTIC 80mm anse haute 215 acier gainée - 3 clés	00060803	10	-	-	-	-	-	-	-	-	-	-	-
Cadenas NAUTIC 80mm anse haute 300 acier gainée - 3 clés	00060804	10	-	-	-	-	-	-	-	-	-	-	-

⚠ Non stocké/Non-stored/Producto no estocado - 📦 Sur stock Europe Zone 1 et Zone 2, nous consulter pour délai d'approvisionnement - 🇪🇺 Epuisement/Stock depletion/Agotamiento del stock

Cadenas de sûreté / 510 - 520 - 530 RESIST



NIVEAU DE SÉCURITÉ



GARANTIE



Acier cémenté

Laiton



Description/Description/Descripción

Corps laiton monobloc. Anse acier cémenté nickelé interchangeable. Mécanisme à goupilles, protection contre le perçage et le crochetage par 2 goupilles en acier traité. Double verrouillage par billes. Bloc de sûreté interchangeable. 2 clés.

One piece brass body Interchangeable nickel-plated case-hardened steel shackle. Pins mechanism. Protection against drilling and picking by 2 pins in treated steel. Double locking with beads. Interchangeable safety block. 2 keys.
Cuerpo de latón monobloque arco de acero cementado niquelado intercambiable. Mecanismo con pasadores, protección contra la perforación y el forzamiento mediante 2 pasadores de acero tratado. Doble bloqueo con bolas. Bloque de seguridad intercambiable. 2 llaves.

Finition/Finish/Acabado

Laiton poli
Polished brass
Latón pulido

Version/Option/Versión

Possibilité MV / mise sur numéro / Mise sur passe

Delivery of padlocks under requested number and keyed alike.

Candado con número impuesto y con la misma combinación

Utilisation/Use/Utilización

Chantier
Construction sites
Obras de construcción



X 2



	40mm	45mm	50mm
	40	45	50
	46	46	46
	18	18,7	18,7
	19	23,4	20
	22	20	20
	7,5	8,5	9,5
Goup.	6	6	6

Designation	Boite	Colis.	Prix	Sachet	Colis.	Prix	Brochable					Colis.	Prix
							France	Euro 1	Euro 2	Euro 3	Euro 4		
Cadenas 510 • 40 mm	00002510	10	-	-	-	-	00202510	-	-	00294570	-	-	-
Cadenas 520 • 45 mm	00002520	10	-	-	-	-	00202520	-	-	-	-	-	-
Cadenas 530 • 50 mm	00002530	10	-	-	-	-	00202530	-	-	-	-	-	-

Non stocké/Non-stored/Producto no estocado - Sur stock Europe Zone 1 et Zone 2, nous consulter pour délai d'approvisionnement - Epuisement/Stock depletion/Agotamiento del stock



Designation	Boite	Colis.	Prix	Sachet	Colis.	Prix	Brochable					Colis.	Prix
							France	Euro 1	Euro 2	Euro 3	Euro 4		
ANSE ACIER MOLYBDENE 7,93 X 25 X 17 POUR REF: 002510	00040906	1	-	-	-	-	-	-	-	-	-	-	-
ANSE ACIER MOLYBDENE7,93 X 50 X 17 POUR REF: 002510	00040907	1	-	-	-	-	-	-	-	-	-	-	-
ANSE ACIER MOLYBDENE7,93 X 75 X 17 POUR REF: 002510	00040908	1	-	-	-	-	-	-	-	-	-	-	-
ANSE ACIER MOLYBDENE7,93 X 102 X 17 POUR REF: 002510	00040909	1	-	-	-	-	-	-	-	-	-	-	-
ANSE ACIER MOLYBDENE8,8 X 25 X 18 POUR REF: 002520	00040910	1	-	-	-	-	-	-	-	-	-	-	-
ANSE ACIER MOLYBDENE8,8 X 50 X 18 POUR REF: 002520	00040911	1	-	-	-	-	-	-	-	-	-	-	-
ANSE ACIER MOLYBDENE8,8 X 75 X 18 POUR REF: 002520	00040912	1	-	-	-	-	-	-	-	-	-	-	-
ANSE ACIER MOLYBDENE8,8 X 102 X 18 POUR REF: 002520	00040913	1	-	-	-	-	-	-	-	-	-	-	-
ANSE ACIER MOLYBDENE 9,5 X 19 X 20 POUR REF: 002530/096510	00040914	1	-	-	-	-	-	-	-	-	-	-	-
ANSE ACIER MOLYBDENE 9,5 X 25 X 20 POUR REF: 002530/096510	00040915	1	-	-	-	-	-	-	-	-	-	-	-
ANSE ACIER MOLYBDENE 9,5 X 38 X 20 POUR REF: 002530/096510	00040916	1	-	-	-	-	-	-	-	-	-	-	-
ANSE ACIER MOLYBDENE 9,5 X 50 X 20 POUR REF: 002530/096510	00040917	1	-	-	-	-	-	-	-	-	-	-	-



NIVEAU DE SÉCURITÉ



GARANTIE



Designation	Boite	Colis.	Prix	Sachet	Colis.	Prix	Brochable					Colis.	Prix
							France	Euro 1	Euro 2	Euro 3	Euro 4		
ANSE ACIER MOLYBDENE 9,5 X 76 X 20 POUR REF: 002530/096510	00040918	1	-	-	-	-	-	-	-	-	-	-	-
ANSE ACIER MOLYBDENE 9,5 X 102 X 20 POUR REF: 002530/096510	00040919	1	-	-	-	-	-	-	-	-	-	-	-
ANSE ACIER MOLYBDENE 11 X 26 X 31 POUR REF: 096512	00040920	1	-	-	-	-	-	-	-	-	-	-	-
ANSE ACIER MOLYBDENE 11 X 50 X 31 POUR REF: 096512	00040921	1	-	-	-	-	-	-	-	-	-	-	-
ANSE ACIER MOLYBDENE 11 X 76 X 31 POUR REF: 096512	00040922	1	-	-	-	-	-	-	-	-	-	-	-
ANSE INOX 7,93 X 19 X 20 POUR REF: 096509	00040926	1	-	-	-	-	-	-	-	-	-	-	-
ANSE INOX 7,93 X 25 X 20 POUR REF: 096509	00040927	1	-	-	-	-	-	-	-	-	-	-	-
ANSE INOX 7,93 X 38 X 20 POUR REF: 096509	00040928	1	-	-	-	-	-	-	-	-	-	-	-
ANSE INOX 7,93 X 50 X 20 POUR REF: 096509	00040929	1	-	-	-	-	-	-	-	-	-	-	-
ANSE INOX 7,93 X 76 X 20 POUR REF: 096509	00040930	1	-	-	-	-	-	-	-	-	-	-	-
ANSE INOX 7,93 X 102 X 20 POUR REF: 096509	00040931	1	-	-	-	-	-	-	-	-	-	-	-
ANSE INOX 7,93 X 25 X 17 POUR REF: 002510	00040932	1	-	-	-	-	-	-	-	-	-	-	-
ANSE INOX 7,93 X 50 X 17 POUR REF: 002510	00040933	1	-	-	-	-	-	-	-	-	-	-	-
ANSE INOX 7,93 X 75 X 17 POUR REF: 002510	00040934	1	-	-	-	-	-	-	-	-	-	-	-
ANSE INOX 7,93 X 102 X 17 POUR REF: 002510	00040935	1	-	-	-	-	-	-	-	-	-	-	-
ANSE INOX 8,8 X 25 X 18 POUR REF: 002520	00040936	1	-	-	-	-	-	-	-	-	-	-	-
ANSE INOX 8,8 X 50 X 18 POUR REF: 002520	00040937	1	-	-	-	-	-	-	-	-	-	-	-
ANSE INOX 8,8 X 75 X 18 POUR REF: 002520	00040938	1	-	-	-	-	-	-	-	-	-	-	-
ANSE INOX 8,8 X 102 X 18 POUR REF: 002520	00040939	1	-	-	-	-	-	-	-	-	-	-	-
ANSE INOX 9,5 X 19 X 20 POUR REF: 002530/096510	00040940	1	-	-	-	-	-	-	-	-	-	-	-
ANSE INOX 9,5 X 25 X 20 POUR REF: 002530/096510	00040941	1	-	-	-	-	-	-	-	-	-	-	-
ANSE INOX 9,5 X 38 X 20 POUR REF: 002530/096510	00040942	1	-	-	-	-	-	-	-	-	-	-	-
ANSE INOX 9,5 X 50 X 20 POUR REF: 002530/096510	00040943	1	-	-	-	-	-	-	-	-	-	-	-
ANSE INOX 9,5 X 76 X 20 POUR REF: 002530/096510	00040944	1	-	-	-	-	-	-	-	-	-	-	-
ANSE INOX 9,5 X 102 X 20 POUR REF: 002530/096510	00040945	1	-	-	-	-	-	-	-	-	-	-	-

☐ Non stocké/Non-stored/Producto no estocado - ☑ Sur stock Europe Zone 1 et Zone 2, nous consulter pour délai d'approvisionnement - ☒ Epuisement/Stock depletion/Agotamiento del stock



NIVEAU DE SÛRETÉ



GARANTIE



Acier cémenté
nickelé

Laiton



Description/Description/Descripción

Corps laiton monobloc. Anse acier cémenté nickelé. Mécanisme à goupilles, protection contre le perçage et le crochetage par 2 goupilles en acier traité. Protecteur d'anse. Double verrouillage par billes. Bloc de sûreté interchangeable. 2 clés.

One piece brass body Case-hardened nickel-plated steel shackle. Pins mechanism. Protection against drilling and picking by 2 pins in treated steel. Shackle protector. Double locking with beads. Interchangeable safety block. 2 keys.
Cuerpo de latón monobloque Arco de acero cementado niquelado. Mecanismo con pasadores, protección contra la perforación y el forzamiento mediante 2 pasadores de acero tratado. Protector de arco. Doble bloqueo con bolas. Bloque de seguridad intercambiable. 2 llaves.



X 2

Finition/Finish/Acabado

Laiton poli
Polished brass
Latón pulido

Version/Option/Versión

Possibilité MV / mise sur numéro / Mise sur passe

Delivery of padlocks under requested number and keyed alike.

Candado con número impuesto y con la misma combinación

Utilisation/Use/Utilización

Chantier
Construction sites
Obras de construcción

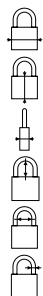

Goup.

	002511	002531	002541
40	40	50	60
72	72	78	85
18	18	18,7	19
19	19	25	25
22	22	20	31
7,5	7,5	9,5	11
Goup.	6	6	6



Designation	Boite	Colis.	Prix	Sachet	Colis.	Prix	France	Euro 1	Euro 2	Euro 3	Euro 4	Colis.	Prix
Cadenas 510P anse protégée 40 mm	00002511	10	-	-	-	-	00202511	-	-	00294232	-	10	-
Cadenas 520P anse protégée 50 mm	00002531	10	-	-	-	-	00202531	-	-	00294233	-	10	-
Cadenas 530P anse protégée 60 mm	00002541	10	-	-	-	-	00202541	-	-	00294234	-	10	-

Cadenas de sûreté / TREK RESIST



NIVEAU DE SÉCURITÉ



GARANTIE



Acier
Molybdène

Laiton



Description/Description/Descripción

Corps laiton monobloc. Anse acier au molybdène. Mécanisme à goupilles. Double verrouillage par billes. Haute résistance contre l'arrachement, la coupe et le sciage. Trou d'écoulement d'eau. 2 clés laiton.

Brass body. Hardened molybdenum shackle. Pin mechanism. Double ball locking. Flow through water hole. 2 brass keys.

Cuerpo de latón. Arco de acero al molibdeno. Mecanismo de pasadores. Doble cierre por bolas. Orificio de circulación de agua. 2 llaves de latón.

Finition/Finish/Acabado

Laiton

Brass

Latón

Version/Option/Versión

40 mm - 45 mm - 50 mm

40 mm - 45 mm - 50 mm

40 mm - 45 mm - 50 mm

Utilisation/Use/Utilización

Extérieur

Outdoor

Exterior



X 2



	295040	215045	225050
	40	45	50
	46	46	46
	19	19	19
	25	25	25
	19	19	19
	6	8	10
Goup	6	6	6

Designation	Boite	Colis.	Prix	Sachet	Colis.	Prix	Brochable					Colis.	Prix
							France	Euro 1	Euro 2	Euro 3	Euro 4		
Cadenas RAID ADVENTURE 40 mm	-	-	-	-	-	-	00295040	00193643 NS	00192643 NS	00194643	-	10	-
Cadenas RAID ADVENTURE 45 mm	-	-	-	-	-	-	00215045	00193644 NS	00192644 NS	00194644	-	10	-
Cadenas RAID ADVENTURE 50 mm	-	-	-	-	-	-	00225050	00193645 NS	00192645 NS	00194645	-	10	-

NS Non stocké/Non-stored/Producto no estocado - Sur stock Europe Zone 1 et Zone 2, nous consulter pour délai d'approvisionnement - E Epuisement/Stock depletion/Agotamiento del stock

Cadenas de sûreté / AMAZONE RESIST



NIVEAU DE SÉCURITÉ



GARANTIE



Laiton

Laiton



Description/Description/Descripción

Corps à lamelles laiton. Anse laiton.
Mécanisme à goupilles. Double
verrouillage par billes. 2 clés laiton
nickelé.

*Laminated Brass body. Brass shackle. Pin
mechanism. Double stainless steel ball
locking. 2 nickel plated brass keys.*

Cuerpo de laminas de latón. Arco de
latón. Mecanismo de pasadores. Doble
cierre por bolas de acero inoxidable. 2
llaves de latón niquelado.

Finition/Finish/Acabado

Laiton

Brass

Latón

Version/Option/Versión

40 mm - 40 mm à combinaison
modifiable -50 mm

40 mm - 40 mm Resettable combination
-50 mm

40 mm - 40 mm Combinación
modificable - 50 mm

Utilisation/Use/Utilización

Extérieur

Outdoor

Exterior



X 2



00240040

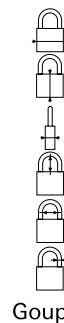

Goup

	280240	240040	280250
	40	40	50
	36	37	39
	22	22	26
	22	25	26
	20	20	24
	6	6	9
Goup	5	-	5

Designation	Boite	Colis.	Prix	Sachet	Colis.	Prix	Brochable				Colis.	Prix	
							France	Euro 1	Euro 2	Euro 3			Euro 4
Cadenas GREEN ADVENTURE 40 mm	-	-	-	-	-	-	00280240	-	00192646 NS	00194646	-	10	-
Cadenas GREEN ADVENTURE 40 mm modif.	-	-	-	-	-	-	00240040	00193648 NS	00192648 NS	00194648	-	10	-
Cadenas GREEN ADVENTURE 50 mm	-	-	-	-	-	-	00280250	00193647 NS	00192647 NS	00194647	-	10	-

NS Non stocké/Non-stored/Producto no estocado - Sur stock Europe Zone 1 et Zone 2, nous consulter pour délai d'approvisionnement - Epuisement/Stock depletion/Agotamiento del stock

Cadenas de sûreté / MACH 3 RESIST



NIVEAU DE SÉCURITÉ



GARANTIE

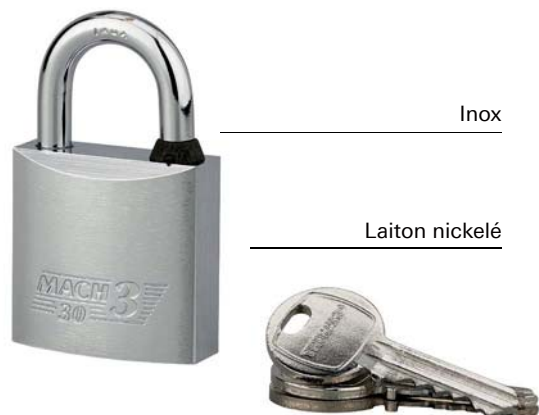

Inox

Laiton nickelé

Description/Description/Descripción

Corps en laiton nickelé monobloc. Anse en acier inoxydable. Mécanisme à goupilles. Double verrouillage par pènes. Joint d'étanchéité. Trou d'écoulement d'eau. 3 clés acier nickelé.

Nickel plated brass body. Stainless steel shackle. Pin mechanism. Double bolt locking. Shackle grommet. Flow through water hole. 3 nickel plated steel keys.

Cuerpo de latón niquelado. Arco de acero inoxidable. Mecanismo de pasadores. Doble anclaje mediante pestillos. Junta de estanqueidad. Orificio de circulación de agua. 3 llaves de acero niquelado.

Finition/Finish/Acabado

Nickelé

Nickel plated

Niquelado

Versión/Option/Versión

Anse haute pour taille 40 mm. Possibilité de clés supplémentaires sur numéro. Cadenas sur numéro imposé et sur même combinaison. Possibilité d'organigramme compatible avec système HG5 (à partir du 40mm), 2 ou 3 clés.

Long shackle for size 40 mm. Extra keys and extra padlocks possible under requested number. Master keyed system available (as from 40 mm). 2 or 3 keys.

Arco alto para tamaño 40 mm. Posibilidad de llaves suplementarias sobre número. Candado con número impuesto y con la misma combinación. Posibilidad de organigrama. 2 or 3 llaves.

Utilisation/Use/Utilización

Industrie

Industry

Industria

094317 094357 094417 094457 094517 094418



Goup.

30	35	40	45	50	40
29	29	39	39	42	39
14	14	16	16	16	16
15	25	22	25	29	128
15	18,5	22	25	29	22
5	5	6	7	8	6
4	4	5	5	5	5

Designation	Boite	Colis.	Prix	Sachet	Colis.	Prix	Brochable					Colis.	Prix
							France	Euro 1	Euro 2	Euro 3	Euro 4		
MACH 3 • 30 mm	00094317	10	-	-	-	-	00194317	-	-	-	-	10	-
MACH 3 • 35 mm	00094357	10	-	-	-	-	00194357	-	-	-	-	10	-
MACH 3 • 40 mm	00094417	10	-	-	-	-	00194417	-	-	-	-	10	-
MACH 3 • 40 mm anse haute	00094418	10	-	-	-	-	00294418	-	-	00294574	-	10	-
MACH 3 • 45 mm	00094457	10	-	-	-	-	00194457	-	-	-	-	10	-
MACH 3 • 50 mm	00094517	10	-	-	-	-	00194517	-	-	-	-	10	-
Jeu de 3 cadenas MACH 3 • 30 mm 6 clés	-	-	-	-	-	-	00294337	-	-	-	-	5	-

Non stocké/Non-stored/Producto no estocado - Sur stock Europe Zone 1 et Zone 2, nous consulter pour délai d'approvisionnement - Epuement/Stock depletion/Agotamiento del stock

Cadenas de sûreté / SKIPPER RESIST



NIVEAU DE SÉCURITÉ



GARANTIE



Inox

Inox

Description/Description/Descripción

Corps inox. Anse inox. Mécanisme à goupilles. Double verrouillage par pènes. Trou d'écoulement d'eau. 2 clés laiton nickelé.

Stainless steel body. Stainless steel shackle. Pin mechanism. Double bolt locking. Flow through water hole. 2 nickel plated brass keys.

Cuerpo de acero inoxidable. Arco de acero inoxidable. Mecanismo de pasadores. Doble anclaje mediante pestillos. Orificio de circulación de agua. 2 llaves de latón niquelado.

Finition/Finish/Acabado

Inox brossé

Polished stainless steel

Acero inoxidable cepillado

Versión/Option/Versión

Simple ancrage pour taille 30mm.

Simple locking 30 mm.

Simple anclaje 30 mm.

Utilisation/Use/Utilización

Marine

Weather proof

Marina



X 2

	280301	280401	280501
	30	40	50
	29	35	43
	12	15	17
	17	21	26
	15	21	25
	4	5	6

Designation	Boite	Colis.	Prix	Sachet	Colis.	Prix	Brochable					Colis.	Prix
							France	Euro 1	Euro 2	Euro 3	Euro 4		
Cadenas BLUE ADVENTURE 30 mm	-	-	-	00980301	10	-	00280301	-	00192640	00194640	-	10	-
Cadenas BLUE ADVENTURE 40 mm	-	-	-	00980401	10	-	00280401	-	00192641	00194641	-	10	-
Cadenas BLUE ADVENTURE 50 mm	-	-	-	00980501	10	-	00280501	00193642	00192642	00194642	-	10	-

Non stocké/Non-stored/Producto no estocado - Sur stock Europe Zone 1 et Zone 2, nous consulter pour délai d'approvisionnement - Epuisement/Stock depletion/Agotamiento del stock

Cadenas de sûreté / MARINOX RESIST



NIVEAU DE SÉCURITÉ



GARANTIE

Anse inox protégée contre la casse, idéal pour le milieu marin



Inox

Inox

Description/Description/Descripción

Corps inox avec protecteur d'anse épaulé. Anse inox. Mécanisme à goupilles. Double verrouillage par billes. 2 clés acier nickelé.
Stainless steel body with raised guard. Stainless steel shackle. Pin mechanism. Double ball locking. 2 nickel plated steel keys.

Cuerpo de acero inoxidable. con protector de arco reforzado. Arco de acero inoxidable. Mecanismo de pasadores. Doble cierre por bolas. 2 llaves de acero niquelado.

Finition/Finish/Acabado

Inox brossé

Polished stainless steel

Acero inoxidable cepillado

Version/Option/Versión

Clés supplémentaires sur modèle. Sans fabrication sur numéro imposé. Cadenas sur même combinaison pour dimension 50 mm.

Extra keys with requested model. Without supplying under request number. Keyed alike padlocks available for size 50 mm.

Llaves suplementarias sobre modelo.

Sin fabricación con número impuesto.

Candado con la misma combinación para tamaños 50 mm.

Utilisation/Use/Utilización

Extérieur, anti-corrosion

Outdoor, Weather proof

Exterior, Anticorrosión



X 2

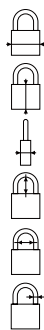

Goup.

	40 mm	50 mm	60 mm
	50	60	76
	15	23	19
	18	22	37
	20	19	28
	7	9,5	10
Goup.	3	3	4

Designation	Boite	Colis.	Prix	Sachet	Colis.	Prix	Brochable					Colis.	Prix
							France	Euro 1	Euro 2	Euro 3	Euro 4		
Cadenas MARINOX 40 mm	00096402	5	-	-	-	-	00196402	00193059 NS	00192059 NS	00194059	-	10	-
Cadenas MARINOX 50 mm	00096502	5	-	00996502	10	-	00196502	00193060 NS	00192060 NS	00194060	-	10	-
Cadenas MARINOX 60 mm	00096602	5	-	-	-	-	00196602	00193706 NS	00192706 NS	00194706	-	5	-

NS Non stocké/Non-stored/Producto no estocado - S Sur stock Europe Zone 1 et Zone 2, nous consulter pour délai d'approvisionnement - E Epuisement/Stock depletion/Agotamiento del stock

Cadenas de sûreté / PROTECTOR RESIST



NIVEAU DE SÛRETÉ



GARANTIE



Molybdène

Acier



00093710



00093712

Description/Description/Descripción

Corps en acier. Anse en acier au molybdène. Double verrouillage par billes. Haute résistance contre l'arrachement, le crochetage, le perçage et la coupe. Mécanisme à goupilles. 2 clés *Steel lock body. Hardened molybdenum shackle. Double ball locking. High resistance against tearing, picking, drilling and cutting. Pin mechanism. 2 keys.* Cuerpo de acero. Arco de acero al molibdeno. Doble cierre por bolas. Alta resistencia contra el arrancamiento, forzamiento, perforación y el corte. Mecanismo de pasadores. 2 llaves. **Finition/Finish/Acabado**

Noir

Black

Negro

Utilisation/Use/Utilización

Chantier

Construction sites

Obras de construcción



X 2

	44 mm	50 mm	63 mm	70 mm	ANSE 1/2 HAUTE 50 mm	ANSE HAUTE 44 mm
	44	50	63	70	50	44
	47	47	52	60	47	47
	27	30	31	34	30	27
	26	27	27	30	50	76
	19	19	31	29	19	19
	6,35	9,5	11,1	14	9,5	6,35
Goup.	6	6	6	6	6	6

Designation	Boite	Colis.	Prix	Sachet	Colis.	Prix	Brochable				Colis.	Prix	
							France	Euro 1	Euro 2	Euro 3			Euro 4
Cadenas PROTECTOR 44 mm	00093707	5	-	-	-	-	00313927	00393707 NS	00392707 NS	00394707	-	5	-
Cadenas PROTECTOR 44 mm anse haute	00093708	5	-	-	-	-	00313928	00393708 NS	00392708 NS	00394708	-	5	-
Cadenas PROTECTOR 50 mm	00093709	5	-	-	-	-	00313929	00393709 NS	00392709 NS	00394709	-	5	-
Cadenas PROTECTOR 50 mm anse 1/2 haute	00093712	5	-	-	-	-	00313932	00393712 NS	00392712 NS	00394712	-	5	-
Cadenas PROTECTOR 63 mm	00093710	5	-	-	-	-	00313930	00393710 NS	00392710 NS	00394710	-	5	-
Cadenas PROTECTOR 70 mm	00093711	5	-	-	-	-	00313931	00393711 NS	00392711 NS	00394711	-	5	-

NS Non stocké/Non-stored/Producto no estocado - ☐ Sur stock Europe Zone 1 et Zone 2, nous consulter pour délai d'approvisionnement - ☒ Epuisement/Stock depletion/Agotamiento del stock

Cadenas de sûreté / 710 - 720 - 720P - S900R RESIST



NIVEAU DE SÉCURITÉ



GARANTIE



Molybdène

Acier cémenté

00096509



00096512



00096511



Description/Description/Descripción
Corps acier cémenté avec traitement contre la corrosion. Anse molybdène interchangeable. Mécanisme à goupilles. Double verrouillage par billes. Protection par platine acier traité contre le perçage. Bloc de sûreté interchangeable. 2 clés.

Case-hardened steel body with rust-proof treatment. Interchangeable molybdenum shackle. Pins mechanism. Double locking with beads. Protected by a steel plate treated against drilling. Interchangeable safety block. 2 keys.

Cuerpo de acero cementado con tratamiento contra la corrosión. Arco de molibdeno intercambiable. Mecanismo de pasadores. Doble bloqueo con bolas. Protección con platina de acero tratado contra la perforación. Bloque de seguridad intercambiable. 2 llaves.

Finition/Finish/Acabado

Laqué noir / Black laquered / Lacado negro

Version/Option/Versión

Possibilité MV / mise sur numéro / Mise sur passe

Delivery of padlocks under requested number and keyed alike.

Candado con número impuesto y con la misma combinación

Utilisation/Use/Utilización

Chantier / Construction sites

Obras de construcción



X 2

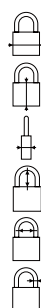

Goup.

	096509	096510	096511	096512
	46	54	54	63,5
	49	49	80	57
	28	30	30	27
	25	25	27	27
	20	20	20	23
	8	9,5	9,5	11
	6	6	6	6

Designation	Boite	Colis.	Prix	Sachet	Colis.	Prix	Brochable					Colis.	Prix
							France	Euro 1	Euro 2	Euro 3	Euro 4		
Cadenas 710 • 46 mm	00096509	10	-	-	-	-	00296509	-	-	-	-	10	-
Cadenas 720 • 54 mm	00096510	10	-	-	-	-	00296510	-	-	-	-	10	-
Cadenas 720P • 54 mm	00096511	10	-	-	-	-	00296511	-	-	-	-	10	-
Cadenas S900R • 63,5 mm	00096512	10	-	-	-	-	00296512	-	-	00294578	-	10	-

⚠ Non stocké/Non-stored/Producto no estocado - 📦 Sur stock Europe Zone 1 et Zone 2, nous consulter pour délai d'approvisionnement - 📦 Epuisement/Stock depletion/Agotamiento del stock





NIVEAU DE SÉCURITÉ



GARANTIE



Designation	Boite	Colis.	Prix	Sachet	Colis.	Prix	Brochable					Colis.	Prix
							France	Euro 1	Euro 2	Euro 3	Euro 4		
ANSE ACIER MOLYBDENE 7,93 X 19 X 20 POUR REF:096509	00040900	1	-	-	-	-	-	-	-	-	-	-	-
ANSE ACIER MOLYBDENE 7,93 X 25 X 20 POUR REF:096509	00040901	1	-	-	-	-	-	-	-	-	-	-	-
ANSE ACIER MOLYBDENE 7,93 X 38 X 20 POUR REF:096509	00040902	1	-	-	-	-	-	-	-	-	-	-	-
ANSE ACIER MOLYBDENE 7,93 X 50 X 20 POUR REF:096509	00040903	1	-	-	-	-	-	-	-	-	-	-	-
ANSE ACIER MOLYBDENE 7,93 X 76 X 20 POUR REF:096509	00040904	1	-	-	-	-	-	-	-	-	-	-	-
ANSE ACIER MOLYBDENE 7,93 X 102 X 20 POUR REF:096509	00040905	1	-	-	-	-	-	-	-	-	-	-	-
ANSE ACIER MOLYBDENE 9,5 X 19 X 20 POUR REF: 002530/096510	00040914	1	-	-	-	-	-	-	-	-	-	-	-
ANSE ACIER MOLYBDENE 9,5 X 25 X 20 POUR REF: 002530/096510	00040915	1	-	-	-	-	-	-	-	-	-	-	-
ANSE ACIER MOLYBDENE 9,5 X 38 X 20 POUR REF: 002530/096510	00040916	1	-	-	-	-	-	-	-	-	-	-	-
ANSE ACIER MOLYBDENE 9,5 X 50 X 20 POUR REF: 002530/096510	00040917	1	-	-	-	-	-	-	-	-	-	-	-



NIVEAU DE SÉCURITÉ



GARANTIE



Designation	Boite	Colis.	Prix	Sachet	Colis.	Prix	Brochable					Colis.	Prix
							France	Euro 1	Euro 2	Euro 3	Euro 4		
ANSE ACIER MOLYBDENE 9,5 X 76 X 20 POUR REF: 002530/096510	00040918	1	-	-	-	-	-	-	-	-	-	-	-
ANSE ACIER MOLYBDENE 9,5 X 102 X 20 POUR REF: 002530/096510	00040919	1	-	-	-	-	-	-	-	-	-	-	-
ANSE ACIER MOLYBDENE 11 X 26 X 31 POUR REF: 096512	00040920	1	-	-	-	-	-	-	-	-	-	-	-
ANSE ACIER MOLYBDENE 11 X 50 X 31 POUR REF: 096512	00040921	1	-	-	-	-	-	-	-	-	-	-	-
ANSE ACIER MOLYBDENE 11 X 76 X 31 POUR REF: 096512	00040922	1	-	-	-	-	-	-	-	-	-	-	-
ANSE INOX 7,93 X 19 X 20 POUR REF: 096509	00040926	1	-	-	-	-	-	-	-	-	-	-	-
ANSE INOX 7,93 X 25 X 20 POUR REF: 096509	00040927	1	-	-	-	-	-	-	-	-	-	-	-
ANSE INOX 7,93 X 38 X 20 POUR REF: 096509	00040928	1	-	-	-	-	-	-	-	-	-	-	-
ANSE INOX 7,93 X 50 X 20 POUR REF: 096509	00040929	1	-	-	-	-	-	-	-	-	-	-	-
ANSE INOX 7,93 X 76 X 20 POUR REF: 096509	00040930	1	-	-	-	-	-	-	-	-	-	-	-
ANSE INOX 7,93 X 102 X 20 POUR REF: 096509	00040931	1	-	-	-	-	-	-	-	-	-	-	-
ANSE INOX 9,5 X 19 X 20 POUR REF: 002530/096510	00040940	1	-	-	-	-	-	-	-	-	-	-	-
ANSE INOX 9,5 X 25 X 20 POUR REF: 002530/096510	00040941	1	-	-	-	-	-	-	-	-	-	-	-
ANSE INOX 9,5 X 38 X 20 POUR REF: 002530/096510	00040942	1	-	-	-	-	-	-	-	-	-	-	-
ANSE INOX 9,5 X 50 X 20 POUR REF: 002530/096510	00040943	1	-	-	-	-	-	-	-	-	-	-	-
ANSE INOX 9,5 X 76 X 20 POUR REF: 002530/096510	00040944	1	-	-	-	-	-	-	-	-	-	-	-
ANSE INOX 9,5 X 102 X 20 POUR REF: 002530/096510	00040945	1	-	-	-	-	-	-	-	-	-	-	-
ANSE INOX 11 X 19 X 20 POUR REF: 096512	00040946	1	-	-	-	-	-	-	-	-	-	-	-
ANSE INOX 11 X 25 X 20 POUR REF: 096512	00040947	1	-	-	-	-	-	-	-	-	-	-	-
ANSE INOX 11 X 38 X 20 POUR REF: 096512	00040948	1	-	-	-	-	-	-	-	-	-	-	-
ANSE INOX 11 X 50 X 20 POUR REF: 096512	00040949	1	-	-	-	-	-	-	-	-	-	-	-
ANSE INOX 11 X 76 X 20 POUR REF: 096512	00040950	1	-	-	-	-	-	-	-	-	-	-	-

Cadenas de sûreté / DOCKER RESIST



NIVEAU DE SÉCURITÉ



GARANTIE

Cadenas blindé anti-coupe avec protection de lanse et double verrouillage par billes inox.



Acier cémenté gainé PVC

Acier gainé PVC



Description/Description/Descripción

Corps à lamelles acier zingué protégé par coque PVC. Anse acier cémenté nickelé gainée PVC. Protecteur d'anse en alliage. Double verrouillage par billes inox. Mécanisme à goupilles. 2 clés laiton nickelé. *Laminated zinc plated steel body, protected by PVC cover. Hardened nickel plated steel shackle PVC protected. Protected shackle by raised guard. Pin mechanism. Double stainless steel ball locking. 2 nickel plated brass keys.*

Cuerpo de láminas de acero cincado protegido con carenado de PVC. Arco de acero cementado niquelado con revestimiento de PVC. Protector de arco de aleación. Doble cierre por bolas de acero inoxidable. Mecanismo de pasadores. 2 llaves de latón niquelado.

Finition/Finish/Acabado

Couleurs assorties / Assorted colors Colores surtidos

Version/Option/Versión

Clés supplémentaires sur modèle. Sans fabrication sur numéro imposé. Cadenas sur même combinaison.

Extra keys with requested model. Without supplying under request number. Keyed alike padlocks available.

Llaves suplementarias sobre modelo. Sin fabricación con número impuesto. Candado con la misma combinación.

Utilisation/Use/Utilización

Chantier / Construction sites bras de construction



X 2

	45 mm	55 mm	70 mm
	45	55	70
	47	84	98
	28	31	36
	18	23	30
	18	22	29
	8,1	11	13,7
Goup.	5	5	5

Designation	Boite	Colis.	Prix	Sachet	Colis.	Prix	Brochable					Colis.	Prix
							France	Euro 1	Euro 2	Euro 3	Euro 4		
Cadenas DOCKER 45 mm	00012802	5	-	-	-	-	00212802	-	-	-	-	6	-
Cadenas DOCKER 55 mm	00012803	5	-	-	-	-	00212803	-	00292400 	00294400	-	6	-
Cadenas DOCKER 65 mm	00012804	5	-	-	-	-	00212804	-	-	00294589	-	6	-

Non stocké/Non-stored/Producto no estocado - Sur stock Europe Zone 1 et Zone 2, nous consulter pour délai d'approvisionnement - Epuisement/Stock depletion/Agotamiento del stock

Cadenas de sûreté / LAND BLINDE RESIST



NIVEAU DE SÛRETÉ



GARANTIE



Land 80 avec blindage pour une sécurité accrue.



Acier chromé

Acier cémenté



Description/Description/Descripción

Corps acier monobloc. Blindage acier cémenté et protection contre le perçage. Anse acier chromé. Mécanisme à goupilles. LE CADENAS DOIT ÊTRE FERMÉ POUR REPRENDRE LA CLÉ. 3 clés acier nickelé. Compact steel body. Hardened steel shell and anti drilling protection Chrome plated steel shackle. Pin mechanism. THE PADLOCK MUST BE CLOSED TO REMOVE THE KEY. 3 nickel plated steel keys.

Cuerpo de acero monobloque. Blindaje de acero cementado y protección contra el taladrado Arco de acero cromado. Mecanismo de pasadores. EL CANDADO DEBE ESTAR CERRADO PARA RETIRAR LA LLAVE. 3 llaves de acero niquelado.

Finition/Finish/Acabado

Chromé / Chrome plated / Cromado

Version/Option/Versión

296405 - Corps laiton. Corps laiton avec double passage d'anse, anse inox 2 clés. Clés supplémentaires sur modèle. Sans fabrication sur le numéro imposé. Cadenas sur même combinaison.

294405 - Brass body. Brass body with double passing shackle 2 keys. Extra keys with requested model. Without supplying under request number. Keyed alike padlocks available.

294405 - Cuerpo de latón. Cuerpo de latón con doble paso de arco, 2 llaves. Llaves suplementarias sobre modelo. Sin fabricación con número impuesto. Candado con la misma combinación

Utilisation/Use/Utilización

Chantier / Construction sites

Obras de construcción



X 3



00096505



60 mm 80 mm 90 mm double anse 80 mm double anse 90 mm

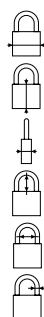

Goup.

61	84	94	80	90
61	61	70	57	75
24	26	28	26,5	29,8
12	20	25	10	20
21	29	46	14/14	18/18
10	12	14	10	11
5	5	5	5	5

Designation	Boite	Colis.	Prix	Sachet	Colis.	Prix	Brochable					Colis.	Prix
							France	Euro 1	Euro 2	Euro 3	Euro 4		
Cadenas LAND blindé 60 mm	00096503	5	-	-	-	-	-	-	-	-	-	-	-
Cadenas LAND blindé 80 mm	00096501	5	-	-	-	-	00296501	00293399 NS	00292399 NS	00294399	-	5	-
Cadenas LAND blindé 90 mm	00096504	5	-	-	-	-	-	-	-	-	-	-	-
Cadenas LAND blindé 90 mm laiton 2 clés	-	-	-	-	-	-	00296405	00293405	00292405 NS	00294405	-	5	-
Cadenas LAND blindé 80 mm double anse	00096505	5	-	-	-	-	00296505	00293505	00292505 NS	00294505 NS	-	5	-
Cadenas LAND blindé 90 mm double anse	00096506	5	-	-	-	-	-	-	-	-	-	-	-

NS Non stocké/Non-stored/Producto no estocado - S Sur stock Europe Zone 1 et Zone 2, nous consulter pour délai d'approvisionnement - E Epuisement/Stock depletion/Agotamiento del stock

Cadenas / LAND BLINDE CP RESIST



NIVEAU DE SÉCURITÉ



GARANTIE



X 3

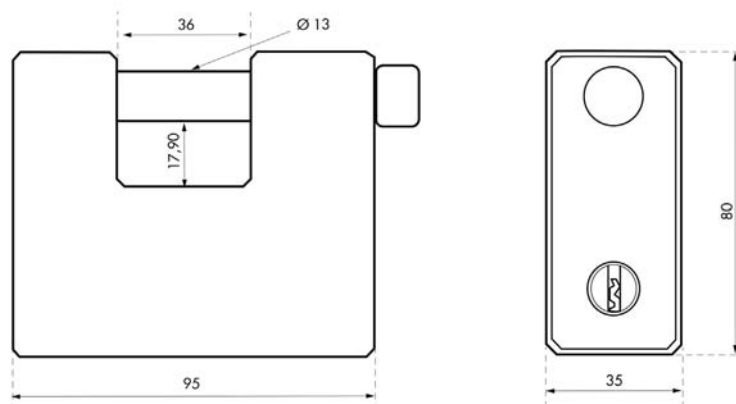

Description/Description/Descripción

Corps acier cémenté trempé. Anse acier cémenté trempé. Verrouillage par bille. Haute résistance contre le perçage, la coupe et le sciage. Fourni avec accessoires de montage du cylindre. A équiper d'un cylindre profi lé 30x10mm (non fourni).

Solid hardened and tempered steel body. Solid hardened and tempered steel shackle. Ball locking. High resistance to drilling, cutting and sawing. Provided with driver and retaining sleeve. Use cylinder 30x10 mm (not included).

Cuerpo de acero cementado templado. Arco de acero cementado templado. Bloqueo con bola. Alta resistencia contra el perforación, el corte y el aserrado. Suministrado con accesorios de montaje del cilindro. Para cilindro perfilado europeo 30x10 mm (no incluido).

Finition/Finish/Acabado

Nickel satin.

Nickel satin.

Níquel satinado

Utilisation/Use/Utilización

Industrie

Industry

Industria

Designation	Boite	Colis.	Prix	Sachet	Colis.	Prix	Brochable					Colis.	Prix
							France	Euro 1	Euro 2	Euro 3	Euro 4		
Cadenas LAND blindé 95mm pour cylindre profilé	00089945	5	-	-	-	-	-	-	-	-	-	-	-

⚠ Non stocké/Non-stored/Producto no estocado - 📦 Sur stock Europe Zone 1 et Zone 2, nous consulter pour délai d'approvisionnement - 📦 Epuisement/Stock depletion/Agotamiento del stock

Cadenas de sûreté / CARGO RESIST



NIVEAU DE SÉCURITÉ



GARANTIE

Cadenas pour organigramme
et usage industriel. Modèle
breveté protégé.



Description/Description/Descripción

Corps laiton monobloc. Anse acier inoxydable. Mécanisme à goupilles. 2 clés.
Brass body. Stainless steel shackle. Pin mechanism. 2 keys.

Cuerpo de latón. Arco de acero inoxidable. Mecanismo de pasadores. 2 llaves.

Finition/Finish/Acabado

Laiton poli
Polished brass
Latón pulido

Versión/Option/Versión

Possibilité de clés supplémentaires sur numéro. Cadenas sur numéro imposé et sur même combinaison. Possibilité d'organigramme compatible avec système HG5 - ADRIATIC - TRANSIT 2.

Extra keys and extra padlocks possible under requested number. Master keyed system available HG5 - ADRIATIC - TRANSIT 2.

Posibilidad de llaves suplementarias sobre número. Candado con número impuesto y con la misma combinación. Posibilidad de organigrama HG5 - ADRIATIC - TRANSIT 2

Utilisation/Use/Utilización

Industrie
Industry
Industria



X 2

	70 mm	85 mm
	73	85
	45	60
	16	20
	25	30
	20	30
	8	10
Goup.	5	5

Designation	Boite	Colis.	Prix	Sachet	Colis.	Prix	Brochable					Colis.	Prix
							France	Euro 1	Euro 2	Euro 3	Euro 4		
Cadenas CARGO 70 mm HG5	00078870	10	-	00978870	5	-	-	-	-	-	-	-	-
Cadenas CARGO 70 mm ADRIATIC	00078871	10	-	00978871	5	-	-	-	-	-	-	-	-
Cadenas CARGO 70 mm TRANSIT 2	00078872	10	-	00978872	5	-	-	-	-	-	-	-	-
Cadenas CARGO 85 mm HG5	00078885	10	-	00978885	5	-	-	-	-	-	-	-	-
Cadenas CARGO 85 mm ADRIATIC	00078886	10	-	00978886	5	-	-	-	-	-	-	-	-
Cadenas CARGO 85 mm TRANSIT 2	00078887	10	-	00978887	5	-	-	-	-	-	-	-	-

Non stocké/Non-stored/Producto no estocado - Sur stock Europe Zone 1 et Zone 2, nous consulter pour délai d'approvisionnement - Epuement/Stock depletion/Agotamiento del stock

Cadenas de sûreté / TRANSIT 2 RESIST



NIVEAU DE SÛRETÉ



GARANTIE



Inox

Laiton



Clés réversibles et carte de propriété pour la reproduction de clés.

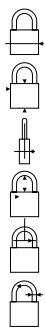

Goup.

	094441	094641	094442
	40	60	40
	39	48	39
	16	20	16
	22	34	60
	22	34	22
	6	10	6
Goup.	8	8	8

Description/Description/Descripción

Corps laiton monobloc. Anse acier inoxydable. Mécanisme à goupilles. Double verrouillage par pènes. Joint d'étanchéité. Trou d'écoulement d'eau. 2 clés laiton nickelé avec carte de propriété permettant la reproduction des clés en usine.

Compact brass body. Stainless steel shackle. Pin mechanism. Double bolt locking. Shackle grommet. Flow through water hole. 2 nickel plated brass keys with personal security card for key copies.

Cuerpo de latón monobloque. Arco de acero inoxidable. Mecanismo de pasadores. Doble cierre mediante pestillos. Junta de estanqueidad. Orificio de circulación de agua. 2 llaves de latón niquelado con título de propiedad que permite la reproducción de las llaves en la fábrica.

Finition/Finish/Acabado

Laiton poli
Polished brass

Latón pulido

Version/Option/Versión

Anse 1/2 haute pour taille 40 mm. Possibilité de clés supplémentaires sur numéro. Possibilité de cadenas sur numéro imposé et sur même combinaison. Possibilité d'organigramme.

1/2 Long shackle size 40 mm. Extra keys and extra padlocks possible under requested number. Master keyed system available.

Arco semialto para tamaño 40 mm.

Possibilité de llaves suplementarias sobre número. Candado con número impuesto y con la misma combinación. Posibilidad de organigrama.

Utilisation/Use/Utilización

Industrie

Industry

Industria



X 2

Designation	Boite	Colis.	Prix	Sachet	Colis.	Prix	Brochable					Colis.	Prix
							France	Euro 1	Euro 2	Euro 3	Euro 4		
Cadenas TRANSIT 2 • 40 mm	00094441	10	-	-	-	-	-	-	-	-	-	-	-
Cadenas TRANSIT 2 • 40 mm anse 1/2 haute	00094442	10	-	-	-	-	-	-	-	-	-	-	-
Cadenas TRANSIT 2 • 60 mm	00094641	10	-	-	-	-	-	-	-	-	-	-	-

⚠ Non stocké/Non-stored/Producto no estocado - 📦 Sur stock Europe Zone 1 et Zone 2, nous consulter pour délai d'approvisionnement - 📦 Epuisement/Stock depletion/Agotamiento del stock

Cadenas de sûreté / INOX RESIST



NIVEAU DE SÉCURITÉ



GARANTIE

Double verrouillage par billes et système clé prisonnière.



Description/Description/Descripción

Corps inox. Anse inox. Mécanisme à goupilles. Double verrouillage par billes inox. Clé « prisonnière » : Le cadenas doit être fermé pour reprendre la clé. 2 clés plates réversibles laiton nickelé avec carte de propriété, permettant la reproduction des clés exclusivement en usine.

Stainless steel case. Stainless steel shackle. Pin mechanism. Double stainless steel ball locking. The padlock must be closed to remove the key. 2 nickel plated brass reversible keys with owner card allowing key duplication in factory.

Cuerpo de acero inoxidable. Arco de acero inoxidable. Mecanismo de pasadores. Doble cierre por bolas de acero inoxidable. El candado tiene que estar cerrado para recoger la llave. 2 llaves de latón niquelado reversibles con tarjeta de propiedad para la reproducción de las llaves en fábrica.

Finition/Finish/Acabado

Inox brossé

Polished stainless steel
Acero inoxidable cepillado

Utilisation/Use/Utilización

Industrie. Organigramme.
Industry. Masterkeying system.
Industria. Organigrama.



X 2



	090404	090405	090406
	40	50	60
	39	45	50
	16	16	20
	25	37	49
	22	29	34
	6	6	10
Goup.	6	6	6



Designation	Boite	Colis.	Prix	Sachet	Colis.	Prix	Brochable					Colis.	Prix
							France	Euro 1	Euro 2	Euro 3	Euro 4		
Cadenas INOX 40 mm	00090404	5	-	-	-	-	-	-	-	-	-	-	-
Cadenas INOX 50 mm	00090405	5	-	-	-	-	-	-	-	-	-	-	-
Cadenas INOX 60 mm	00090406	5	-	-	-	-	-	-	-	-	-	-	-

⚠ Non stocké/Non-stored/Producto no estocado - 📄 Sur stock Europe Zone 1 et Zone 2, nous consulter pour délai d'approvisionnement - 📦 Epuisement/Stock depletion/Agotamiento del stock

Cadenas de sûreté / RB RESIST



NIVEAU DE SÉCURITÉ



GARANTIE



CODE
MODIFIABLE

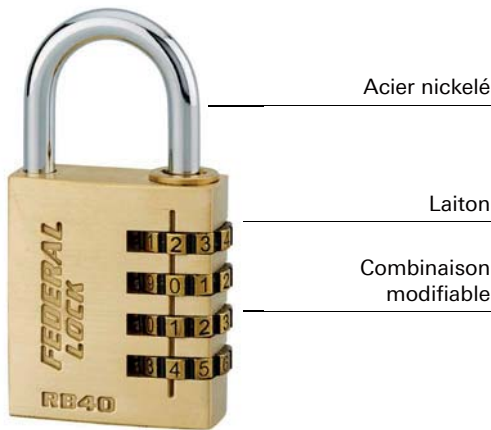

Description/Description/Descripción

Corps laiton monobloc. Anse acier nickelé. Mécanisme à viroles. Combinaison modifiable (10 000 combinaisons possibles).

Compact brass body. Nickel plated steel shackle. Dial mechanism. Resettable combination (10 000 combinations available).

Cuerpo de latón monobloque. Arco de acero niquelado. Mecanismo con virolas. Combinación modificable (10 000 combinaciones posibles).

Finition/Finish/Acabado

Laiton poli

Polished brass

Latón pulido

Utilisation/Use/Utilización

Chantier

Construction sites

Obras de construcción



	30 mm	40 mm
	30	40
	36	45
	13	16
	24	25
	14	22
	4,8	6

Designation	Boite	Colis.	Prix	Sachet	Colis.	Prix	Brochable					Colis.	Prix
							France	Euro 1	Euro 2	Euro 3	Euro 4		
Cadenas RB 30 mm	00013946	10	-	00913946	10	-	00113946	00193713 NS	00192713 NS	00194713	-	6	-
Cadenas RB 40 mm	00013947	10	-	00913947	10	-	00113947	00193714 NS	00192714 NS	00194714	-	6	-

NS Non stocké/Non-stored/Producto no estocado - ☑ Sur stock Europe Zone 1 et Zone 2, nous consulter pour délai d'approvisionnement - E Epuisement/Stock depletion/Agotamiento del stock

Cadenas de sûreté / TANKER 2 RESIST



NIVEAU DE SÉCURITÉ



GARANTIE



CODE
MODIFIABLE



Inox A2

Laiton

Combinaison
modifiable

00090803

Description/Description/Descripción

Corps laiton. Anse acier inoxydable A2. Mécanisme à 4 viroles. Combinaison modifiable par clé. 10 000 combinaisons possibles.

Brass body. Stainless steel shackle A2. Dial mechanism. Resettable combination. 10 000 combinations available.

Cuerpo de latón. Arco de acero inoxidable A2. Mecanismo con virolas. Combinación modificable. 10.000 combinaciones posibles.

Finition/Finish/Acabado

Poli

Polished

Pulido

Version/Option/Versión

Anse 1/2 haute.

1/2 long shackle.

Arco semi alto.

Utilisation/Use/Utilización

Chantier

Construction sites

Obras de construcción

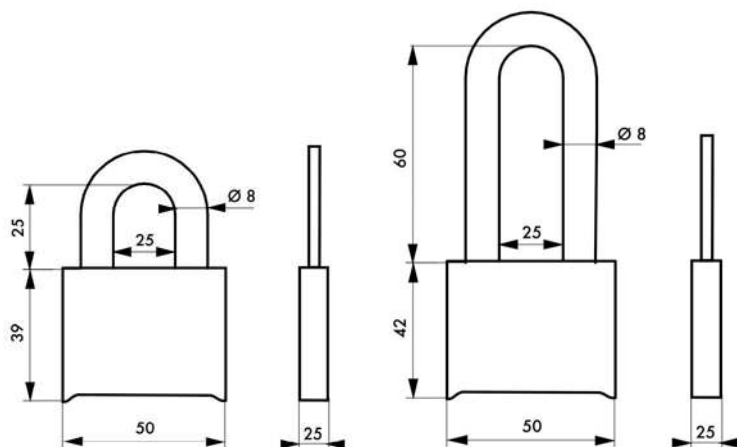

00090804

Designation	Boite	Colis.	Prix	Sachet	Colis.	Prix	Brochable					Colis.	Prix
							France	Euro 1	Euro 2	Euro 3	Euro 4		
Cadenas TANKER 2 à combinaison modifiable	00090803	10	-	00990803	10	-	-	-	-	-	-	-	-
Cadenas TANKER 2 à combinaison modifiable anse 1/2 haute	00090804	10	-	00990804	10	-	-	-	-	-	-	-	-

⚠ Non stocké/Non-stored/Producto no estocado - 📍 Sur stock Europe Zone 1 et Zone 2, nous consulter pour délai d'approvisionnement - ⚠ Epuement/Stock depletion/Agotamiento del stock

Cadenas de sûreté / SR - SRH - SRP RESIST



NIVEAU DE SÉCURITÉ



GARANTIE



CODE MODIFIABLE



00090805



00090807

Description/Description/Descripción

Corps en acier. Anse en acier au molybdène. Double verrouillage par billes. Haute résistance contre l'arrachement, le crochetage, le perçage et la coupe. Combinaison modifiable à 4 viroles. *Steel lock body. Hardened molybdenum shackle. Double ball locking. High resistance against tearing, picking, drilling and cutting. 4 Dial, resettable combination.*

Cuerpo de acero. Arco de acero al molibdeno. Doble cierre por bolas. Alta resistencia contra el arrancamiento, forzamiento, perforación y el corte. 4 viroles, combinación modificable.

Finition/Finish/Acabado

Noir
Black
Negro

Version/Option/Versión

Anse demi haute. Anse épaulée.
Demi long shackle. Protected shackle.
Arco semi alto. Protector de arco.

Utilisation/Use/Utilización

Chantier
Construction sites
Obras de construcción

090805 090806 090807

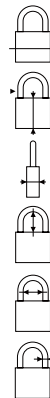

	62	62	62
	54	54	77
	34	34	34
	25	50	25
	22	22	22
	11	11	11

Designation	Boite	Colis.	Prix	Sachet	Colis.	Prix	Brochable				Colis.	Prix	
							France	Euro 1	Euro 2	Euro 3			Euro 4
Cadenas SR 60 mm à combinaison modifiable	00090805	1	-	-	-	-	00290805	00293998 NS	00292998 NS	00294998	-	5	-
Cadenas SRH 60 mm à combinaison modifiable	00090806	1	-	-	-	-	00290806	00293999 NS	00292999 NS	00294999	-	5	-
Cadenas SRP 60 mm à combinaison modifiable	00090807	1	-	-	-	-	00290807	00293300 NS	00292300 NS	00294300	-	5	-

NS Non stocké/Non-stored/Producto no estocado - Sur stock Europe Zone 1 et Zone 2, nous consulter pour délai d'approvisionnement - Epuisement/Stock depletion/Agotamiento del stock

Antivol / TWISTY

MOBILITE



NIVEAU DE SÉCURITÉ



GARANTIE



Acier gainé
PVC

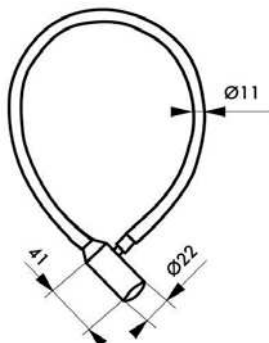

Description/Description/Descripción

Câble acier Ø 5 mm, longueur 0,50 m. Gainé PVC. Mécanisme à goupilles. 2 clés nickelées.

Steel cable Ø 5 mm, length 0,50 m. PVC sheathed. Pin mechanism. 2 nickel plated keys.

Cable de acero Ø 5 mm, longitud 0,50 m. Revestimiento de PVC. Mecanismo de pasadores. 2 llaves niqueladas.

Finition/Finish/Acabado

Couleurs assorties

Assorted colours

Colores surtidos

Utilisation/Use/Utilización

Cycles

Bicycles

Bicicletas



X 2

Designation	Boite	Colis.	Prix	Sachet	Colis.	Prix	Brochable					Colis.	Prix
							France	Euro 1	Euro 2	Euro 3	Euro 4		
ANTIVOL Ø 5 long. 0,50 m 2 clés	-	-	-	00901017	30	-	00301017	00392067	00392067	00392067	-	10	-
Lot de 3 ANTIVOLS Ø 5 long. 0,50 m 6 clés identiques	-	-	-	-	-	-	00331017	00331017	00331017	00331017	-	10	-

Antivol / TWISTY

MOBILITE



NIVEAU DE SÉCURITÉ



GARANTIE



Acier gainé
PVC

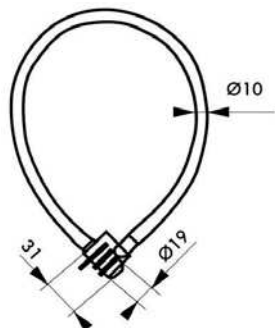

Combinaison fixe

Description/Description/Descripción

Câble acier Ø 5 mm, longueur 0,50 m. Gainé PVC. Mécanisme à combinaison à 3 viroles.

Cable steel Ø 5 mm, length 0,50 m.

PVC sheathed. Mechanism with 3 dial combination

Cable de acero Ø 5 mm, longitud 0,50 m.

Revestimiento de PVC. Mecanismo de combinación con 3 viroles.

Finition/Finish/Acabado

Couleurs assorties

Assorted colours

Colores surtidos

Utilisation/Use/Utilización

Cycles

Bicycles

Bicicletas



CODE
FIXE

Designation	Boite	Colis.	Prix	Sachet	Colis.	Prix	Brochable					Colis.	Prix
							France	Euro 1	Euro 2	Euro 3	Euro 4		
ANTIVOL Ø 5 long. 0,50 m combi. fixe	-	-	-	00901016	10	-	00301016	00392068	00392068	00392068	00395068	10	-

Ⓜ Non stocké/Non-stored/Producto no estocado - Ⓜ Sur stock Europe Zone 1 et Zone 2, nous consulter pour délai d'approvisionnement - Ⓜ Epuïsement/Stock depletion/Agotamiento del stock

Antivol / TWISTY

MOBILITE

Antivol simple à ranger grâce à sa spirale.



NIVEAU DE SÉCURITÉ



GARANTIE

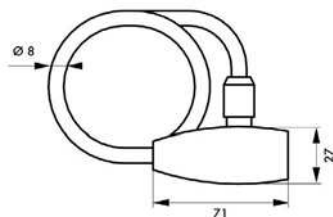

Longueur de câble : 1,50 m

Description/Description/Descripción

Câble acier gainé PVC. Ø 8 mm, longueur 1,50 m. Gainé PVC. Mécanisme à goupilles. Support de fixation 2 clés laiton nickelé.

PVC sheathed cable. Pin mechanism. Fixing device 2 nickel plated brass keys.

Cable de acero con revestimiento de PVC. Mecanismo de pasadores. Soporte de fijación. 2 llaves latón niquelado

Finition/Finish/Acabado

Couleurs assorties

Assorted colours

Colores surtidos

Utilisation/Use/Utilización

Cycles

Bicycles

Bicicletas



X 2

Designation

Designation	Boite	Colis.	Prix	Sachet	Colis.	Prix	Brochable					Colis.	Prix
							France	Euro 1	Euro 2	Euro 3	Euro 4		
ANTIVOL à câble Ø 8 long. 1,50 m avec support 2 clés	-	-	-	-	-	-	00303501	00392069	00392069	00392069	00395069	10	-
Lot de 3 ANTIVOLS à câble Ø 8 long. 1,50 m avec support 6 clés identiques	-	-	-	-	-	-	00333501	00333501	00333501	00333501	-	10	-

Antivol / TWISTY

MOBILITE

Acier gainé PVC



NIVEAU DE SÉCURITÉ



GARANTIE

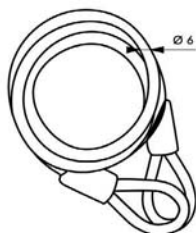

Longueur de câble 1,80 m

Description/Description/Descripción

Câble acier gainé PVC. Mécanisme à goupilles. Support de fixation 2 clés laiton nickelé.

PVC sheathed cable. Pin mechanism. Fixing device 2 nickel plated brass keys.

Cable de acero con revestimiento de PVC. Mecanismo de pasadores. Soporte de fijación. 2 llaves latón niquelado.

Mecanismo de pasadores. Soporte de fijación. 2 llaves latón niquelado.

Finition/Finish/Acabado

Noir

Black

Negro

Utilisation/Use/Utilización

Cycles

Bicycles

Bicicletas



X 2

Designation

Designation	Boite	Colis.	Prix	Sachet	Colis.	Prix	Brochable					Colis.	Prix
							France	Euro 1	Euro 2	Euro 3	Euro 4		
ANTIVOL à câble Ø 12 long. 1,80 m avec support 2 clés	-	-	-	-	-	-	00300345	-	00300345	-	-	10	-
Câble Ø 6 long. 1,80 m	-	-	-	00900346	30	-	00200346	-	00200346	-	-	10	-

Ⓝ Non stocké/Non-stored/Producto no estocado - Ⓜ Sur stock Europe Zone 1 et Zone 2, nous consulter pour délai d'approvisionnement - Ⓜ Epuisement/Stock depletion/Agotamiento del stock

Antivol / UP

MOBILITE



NIVEAU DE SÉCURITÉ



GARANTIE



Description/Description/Descripción
Corps alliage gainé PVC. Anse acier cémenté gainé PVC. Mécanisme à 5 goupilles. 2 clés plates en acier nickelé.

PVC sheathed alloy moulded body. PVC sheathed steel shackle. 5 pin mechanism. 2 nickel plated steel keys.

Cuerpo de aleación con revestimiento de PVC. Arco de acero cementado con revestimiento de PVC. Mecanismo de 5 pasadores. 2 llaves de acero niquelado.

Finition/Finish/Acabado

PVC noir
black PVC
PVC negro

Utilisation/Use/Utilización

Cycles
Bicycles
Bicicletas



X 2



Designation	Boite	Colis.	Prix	Sachet	Colis.	Prix	Brochable					Colis.	Prix
							France	Euro 1	Euro 2	Euro 3	Euro 4		
Antivol U anse acier cémenté gainée Ø 10 larg: 70 mm, Haut : 300 mm	-	-	-	-	-	-	00518880	00592070	00592070	00592070	00595070	10	-

Antivol / LOOPS

MOBILITE



NIVEAU DE SÉCURITÉ



GARANTIE

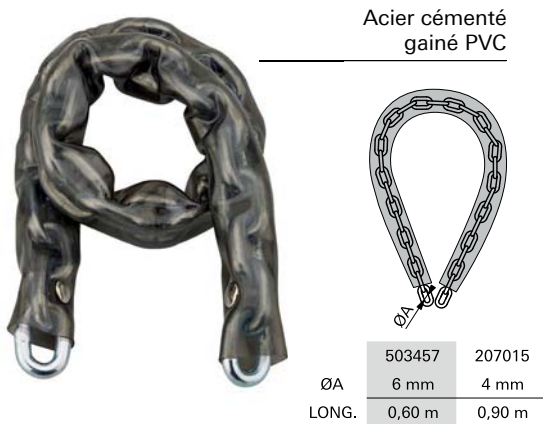

Description/Description/Descripción

Câble acier, gainé PVC

Steel cable, PVC sheathed.

Cable acero con revestimiento de PVC

Finition/Finish/Acabado

Couleurs assorties

Assorted colours

Colores surtidos

Utilisation/Use/Utilización

Cycles - Abris de jardin

Bicycles - Garden shelter

Bicicletas - Refugios de jardin

Designation	Boite	Colis.	Prix	Sachet	Colis.	Prix	Brochable					Colis.	Prix
							France	Euro 1	Euro 2	Euro 3	Euro 4		
CHAÎNE gainée PVC Ø 6 long. 0,60 m	-	-	-	00903456	30	-	00503457	-	00592458	-	-	5	-
CHAÎNE gainée PVC Ø 6 long. 0,90 m	-	-	-	00903458	10	-	00503458	-	00592459	-	-	5	-
CHAÎNE gainée PVC Ø 4 long. 0,90 m avec cadenas 40mm anse inox 2 clés	-	-	-	-	-	-	00207015	-	-	00207015	-	5	-

Ⓜ Non stocké/Non-stored/Producto no estocado - Ⓜ Sur stock Europe Zone 1 et Zone 2, nous consulter pour délai d'approvisionnement - Ⓜ Epuïsement/Stock depletion/Agotamiento del stock

Antivol / TWISTY

MOBILITE



NIVEAU DE SÉCURITÉ



GARANTIE

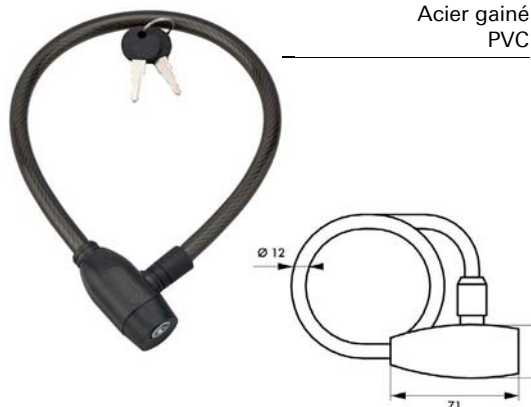

Description/Description/Descripción

Câble acier gainé PVC. Mécanisme à goupilles. 2 clés laiton nickelé. *PVC sheathed cable. Pin mechanism. 2 nickel plated brass keys.*

Cable de acero con revestimiento de PVC. Mecanismo de pasadores. 2 llaves latón niquelado.

Finition/Finish/Acabado

Noir
Black
Negro

Utilisation/Use/Utilización

Cycles
Bicycles
Bicicletas



X 2

Designation	Boite	Colis.	Prix	Sachet	Colis.	Prix	Brochable					Colis.	Prix
							France	Euro 1	Euro 2	Euro 3	Euro 4		
ANTIVOL à câble Ø 12 long. 0,60 m 2 clés	-	-	-	-	-	-	00301118	00301118	00301118	-	-	10	-

Antivol / SOFTY

MOBILITE

Revêtement silicone pour protéger le vélo d'éventuelles rayures



NIVEAU DE SÉCURITÉ



GARANTIE

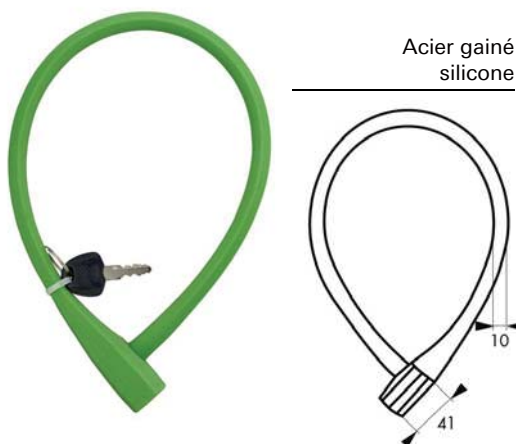

Description/Description/Descripción

Câble acier gainé silicone. Mécanisme à goupilles. 2 clés acier nickelé. *Silicone sheathed cable. Pin mechanism. 2 nickel plated steel keys.*

Cable de acero con revestimiento de silicona. Mecanismo de pasadores. 2 llaves acero niquelado.

Finition/Finish/Acabado

Couleurs assorties.
Assorted colors.
Colores surtidos.

Utilisation/Use/Utilización

Cycles
Bicycles
Bicicletas



X 2

Designation	Boite	Colis.	Prix	Sachet	Colis.	Prix	Brochable					Colis.	Prix
							France	Euro 1	Euro 2	Euro 3	Euro 4		
ANTIVOL à câble Ø 10 long. 0,60 m 2 clés	-	-	-	-	-	-	00301121	00301121	00301121	00301121	-	10	-

⚠ Non stocké/Non-stored/Producto no estocado - 📦 Sur stock Europe Zone 1 et Zone 2, nous consulter pour délai d'approvisionnement - 📦 Epuisement/Stock depletion/Agotamiento del stock

Antivol / SOFTY

MOBILITE



NIVEAU DE SÉCURITÉ



GARANTIE

Revêtement silicone pour protéger le vélo d'éventuelles rayures

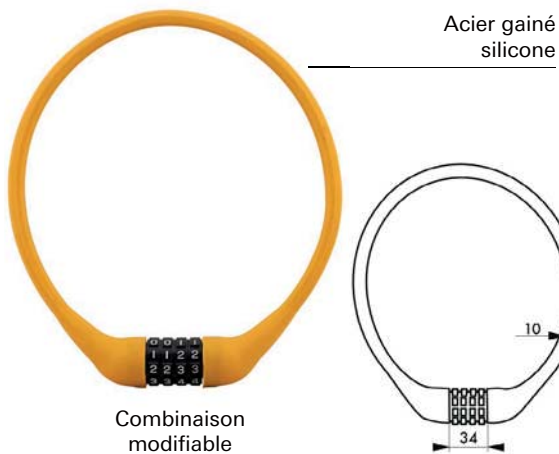

Acier gainé silicone

Combinaison modifiable

Description/Description/Descripción
Câble acier gainé silicone. Mécanisme à goupilles. Mécanisme à 4 viroles à combinaison modifiable.

Silicone sheathed cable. Pin mechanism. 4 dials mechanism and resettable combination.

Cable de acero con revestimiento de silicona. Mecanismo de pasadores. Mecanismo de 4 virolas con combinación modifi cable.

Finition/Finish/Acabado

Couleurs assorties.

Assorted colors

Colores surtidos.

Utilisation/Use/Utilización

Cycles

Bicycles

Bicicletas



CODE MODIFIABLE



Designation	Boite	Colis.	Prix	Sachet	Colis.	Prix	Brochable					Colis.	Prix
							France	Euro 1	Euro 2	Euro 3	Euro 4		
ANTIVOL à câble Ø 10 long. 0,60 m à combinaison modifiable	-	-	-	-	-	-	00301122	00301122	00301122	00301122	-	10	-

Antivol / TWISTY

MOBILITE



NIVEAU DE SÉCURITÉ



GARANTIE



Acier gainé PVC

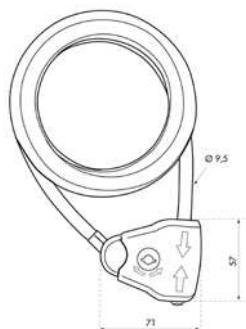

Description/Description/Descripción

Câble acier gainé PVC

Steel cable PVC sheathed.

Cable acero con revestimiento de PVC

Finition/Finish/Acabado

Noir

Black

Negro

Version/Option/Versión

310180 - Ajustable, anse inox 2 clés

310180 - Adjustable, 2 keys.

310180 - Ajustable, 2 llaves.

Utilisation/Use/Utilización

Cycles - Abris de jardin

Bicycles - Garden shelter

Bicicletas - Refugios de jardin

Designation	Boite	Colis.	Prix	Sachet	Colis.	Prix	Brochable					Colis.	Prix
							France	Euro 1	Euro 2	Euro 3	Euro 4		
CABLE Ø 10 long. 1,80 m ajustable, 2 clés	-	-	-	00910180	-	-	00310180	00310180	00310180	00310180	-	10	-

⚠ Non stocké/Non-stored/Producto no estocado - 📍 Sur stock Europe Zone 1 et Zone 2, nous consulter pour délai d'approvisionnement - ⚠ Epuement/Stock depletion/Agotamiento del stock

Antivol / TWISTY

MOBILITE



NIVEAU DE SÉCURITÉ



GARANTIE



Acier gainé
PVC

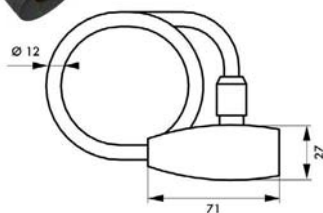

Longueur de câble : 1,80 m

Description/Description/Descripción

Câble acier gainé PVC. Mécanisme à goupilles. Support de fixation. 2 clés laiton nickelé.

PVC sheathed cable. Pin mechanism. Fixing device. 2 nickel plated brass keys.

Cable de acero con revestimiento de PVC.

Mecanismo de pasadores. Soporte de fijación. 2 llaves latón niquelado.

Finition/Finish/Acabado

Noir

Black

Negro

Utilisation/Use/Utilización

Cycles

Bicycles

Bicicletas



X 2

Designation	Boite	Colis.	Prix	Sachet	Colis.	Prix	Brochable					Colis.	Prix
							France	Euro 1	Euro 2	Euro 3	Euro 4		
ANTIVOL à câble Ø 12 long. 1,80 m avec support 2 clés	-	-	-	-	-	-	00300336	00300336	00300336	00300336	-	10	-

Antivol / SCORP

MOBILITE

Antivol avec une résistance accrue
grâce au blindage du câble.



NIVEAU DE SÉCURITÉ



GARANTIE



Acier gainé
PVC

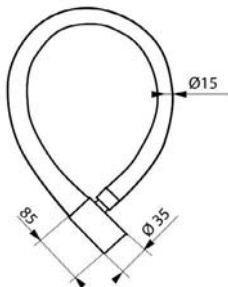

Longueur de câble : 0,85 m

Description/Description/Descripción

Câble acier, gainé PVC. 500601 - câble blindé Mécanisme à disques avec cache de protection. 2 clés plates en acier nickelé.

Steel cable with PVC sheathed. 500601 - reinforced cable. Disc mechanism with protective cover. 2 nickel plated steel keys.

Cable de acero revestimiento de PVC.

500601 - cable blindado. Mecanismo de discos con tapa de protección. 2 llaves de acero niquelado.

Finition/Finish/Acabado

Noir / Black / Negro

Utilisation/Use/Utilización

Cycles - Motos - Barrières

Bicycles - Motorcycles - Fences

Bicicletas - Motos - Barreras



X 2

Designation	Boite	Colis.	Prix	Sachet	Colis.	Prix	Brochable					Colis.	Prix
							France	Euro 1	Euro 2	Euro 3	Euro 4		
ANTIVOL MOTO câble Ø 15 long. 0,85 m	-	-	-	-	-	-	00500223	00592072	00592072	00592072	-	5	-
ANTIVOL MOTO câble blindé Ø 18 long. 0,85 m	-	-	-	-	-	-	00500601	00500601	00500601	-	-	5	-

Ⓜ Non stocké/Non-stored/Producto no estocado - ☑ Sur stock Europe Zone 1 et Zone 2, nous consulter pour délai d'approvisionnement - ☒ Epuisement/Stock depletion/Agotamiento del stock

Antivol / TWISTY

MOBILITE



NIVEAU DE SÉCURITÉ



GARANTIE



Acier gainé
PVC

Combinaison
modifiable

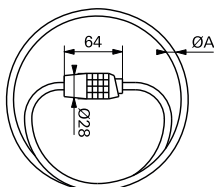

	391007	391008
ØA	10mm	10 mm
LONG.	0,65 m	1,80 m

Description/Description/Descripción
Câble gainé PVC. Mécanisme à 4 viroles à combinaison modifiable, 10 000 combinaisons possibles. 391008 - Support de fixation.

PVC sheathed cable. 4 dials mechanism and resettable combinations, 10 000 possible combinations. 391008 - Fixing device.
Cable con revestimiento de PVC. Mecanismo de 4 virolas con combinación modifiable, 10.000 combinaciones posibles. 391008 - Soporte de fijación.

Finition/Finish/Acabado

Noir / Black / Negro

Utilisation/Use/Utilización

Cycles / Bicycles / Bicicletas



CODE
MODIFIABLE



Designation	Boite	Colis.	Prix	Sachet	Colis.	Prix	Brochable					Colis.	Prix
							France	Euro 1	Euro 2	Euro 3	Euro 4		
ANTIVOL à câble Ø 10 long. 0,65 m à combinaison modifiable	-	-	-	-	-	-	00391007	00391007	00391007	-	-	10	-
ANTIVOL à câble Ø 10 long. 1,80 m à combinaison modifiable avec support	-	-	-	-	-	-	00391008	00392071	00392071	00392071	00395071 ^{NS}	10	-

Antivol / TWISTY

MOBILITE



NIVEAU DE SÉCURITÉ



GARANTIE



Acier gainé PVC

Combinaison
modifiable

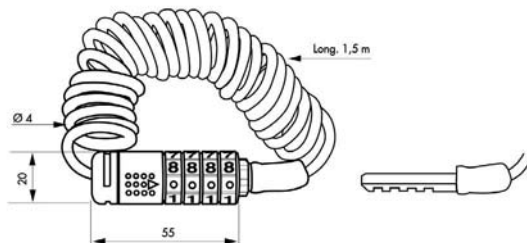

Description/Description/Descripción

Câble acier gainé PVC. Mécanisme à 4 viroles à combinaison modifiable. 10 000 combinaisons possibles.

Steel PVC sheathed cable. 4 dials mechanism and resettable combinations. 10 000 possible combinations.

Cable de acero con revestimiento de PVC. Mecanismo de 4 virolas con combinación modifiable. 10 000 combinaciones posibles.

Finition/Finish/Acabado

Noir / Black / Negro

Utilisation/Use/Utilización

Cycles - Trotinette électrique

Bicycles - Electric scooter

Bicicletas - Electric scooter



CODE
MODIFIABLE

Designation	Boite	Colis.	Prix	Sachet	Colis.	Prix	Brochable					Colis.	Prix
							France	Euro 1	Euro 2	Euro 3	Euro 4		
ANTIVOL à câble Ø 4 long. 1,50 m à combinaison modifiable	-	-	-	-	-	-	00277999	00293279	00292279	00294279	-	5	-

^{NS} Non stocké/Non-stored/Producto no estocado - Sur stock Europe Zone 1 et Zone 2, nous consulter pour délai d'approvisionnement - Epuisement/Stock depletion/Agotamiento del stock

Antivol / TWISTY

MOBILITE



NIVEAU DE SÉCURITÉ



GARANTIE



Acier gainé
PVC

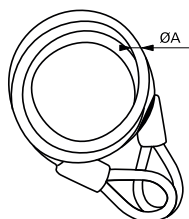

	510120	308200	308600	308120
ØA	10 mm	8 mm	8 mm	8 mm
LONG.	1,20 m	2,00 m	6,00 m	12,00 m

Description/Description/Descripción

Câble acier gainé PVC

Steel cable PVC sheathed.

Cable acero con revestimiento de PVC

Finition/Finish/Acabado

Noir / Black / Negro

Version/Option/Versión

310180 - Ajustable, anse inox 2 clés

310180 - Adjustable, 2 keys.

310180 - Ajustable, 2 llaves.

Utilisation/Use/Utilización

Cycles - Abris de jardin

Bicycles - Garden shelter

Bicicletas - Refugios de jardin

Designation	Boite	Colis.	Prix	Sachet	Colis.	Prix	Brochable					Colis.	Prix
							France	Euro 1	Euro 2	Euro 3	Euro 4		
CABLE Ø 10 long. 1,20 m	-	-	-	00910120	20	-	00510120	00510120	00510120	-	-	10	-
CABLE Ø 8 long. 2,00 m	-	-	-	00908200	20	-	00308200	00308200	00308200	00308200	-	10	-
CABLE Ø 8 long. 6,00 m	-	-	-	00908600	20	-	00308600	00308600	00308600	00308600	00308600	10	-
CABLE Ø 8 long. 12,00 m	-	-	-	00908120	20	-	00308120	00308120	00308120	00308120	00308120	10	-

Antivol / UP

MOBILITE



NIVEAU DE SÉCURITÉ



GARANTIE



Acier gainé
PVC

combinaison
modifiable

Acier gainé
PVC

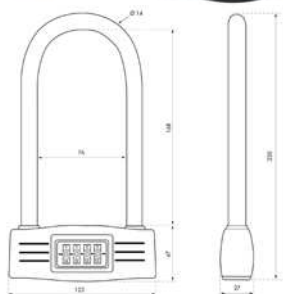

Description/Description/Descripción

Corps alliage gainé PVC. Anse acier cémenté gainé PVC. Mécanisme à 4 viroles à combinaison modifiable. Câble acier, gainé PVC, avec boucles serties.

PVC sheathed alloy moulded body. PVC sheathed steel shackle. 4 dials mechanism and resettable combinations. Steel cable, PVC sheathed.

Cuerpo de aleación con revestimiento de PVC. Arco de acero cementado con revestimiento de PVC. Mecanismo de 4 virolas con combinación modifiable cable. Cable acero con revestimiento de PVC.

Finition/Finish/Acabado

PVC noir / Black PVC / PVC Negro

Utilisation/Use/Utilización

Cycles / Bicycles / Bicicletas



CODE
MODIFIABLE

Designation	Boite	Colis.	Prix	Sachet	Colis.	Prix	Brochable					Colis.	Prix
							France	Euro 1	Euro 2	Euro 3	Euro 4		
Antivol U à combinaison avec câble Ø12mm x120cm	-	-	-	-	-	-	00580420	00580420	00580420	00580420	-	5	-

⚠ Non stocké/Non-stored/Producto no estocado - 📦 Sur stock Europe Zone 1 et Zone 2, nous consulter pour délai d'approvisionnement - 📦 Epuisement/Stock depletion/Agotamiento del stock

Antivol / TWISTY

MOBILITE



NIVEAU DE SÉCURITÉ



GARANTIE



CODE MODIFIABLE

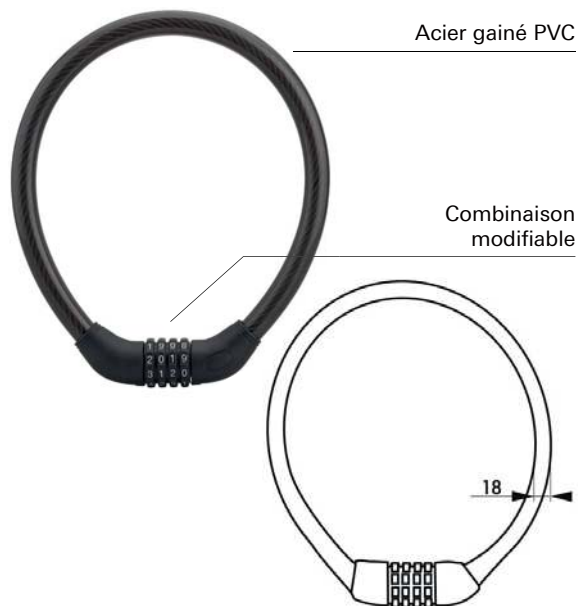

Acier gainé PVC

Combinaison modifiable

Description/Description/Descripción

Câble acier gainé PVC. Mécanisme à 4 viroles à combinaison modifiable.

Steel PVC sheathed cable. 4 dials mechanism and resettable combinations.

Cable de acero con revestimiento de PVC. Mecanismo de 4 virolas con combinación modifiable.

Finition/Finish/Acabado

Noir

Black

Negro

Utilisation/Use/Utilización

Cycles

Bicycles

Bicicletas

Designation	Boîte	Colis.	Prix	Sachet	Colis.	Prix	Brochable					Colis.	Prix
							France	Euro 1	Euro 2	Euro 3	Euro 4		
ANTIVOL à câble Ø 18 long. 0,60 m	-	-	-	-	-	-	00391010	-	-	-	-	10	-

Antivol / SCORP

MOBILITE



NIVEAU DE SÉCURITÉ



GARANTIE



X 2



Cable blindé gainé PVC

Description/Description/Descripción

Câble blindé gainé PVC. Mécanisme à goupilles. 2 clés réversibles. Reinforced cable with PVC sheathed. Pin mechanism. 2 reversible keys.

Cable de acero revestimiento de PVC. Mecanismo de pasadores. 2 llaves reversibles.

Finition/Finish/Acabado

Noir

Black

Negro

Utilisation/Use/Utilización

Cycles

Bicycles

Bicicletas

Longueur de câble : 1 m

Designation	Boîte	Colis.	Prix	Sachet	Colis.	Prix	Brochable					Colis.	Prix
							France	Euro 1	Euro 2	Euro 3	Euro 4		
Antivol câble blindé Ø 18 long. 0,85 m	-	-	-	-	-	-	00500602	-	-	-	-	5	-

Antivol / LOOPS

MOBILITE



NIVEAU DE SÉCURITÉ



GARANTIE



Acier cémenté
gainé PVC

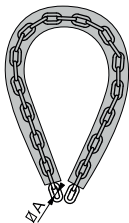

	508558	508560	563457
ØA	8 mm	8 mm	6 mm
LONG.	0,90 m	1,20 m	0,60 m

Description/Description/Descripción

Chaîne acier cémenté zingué. Gaine PVC
Hardened zinc plated steel chain. PVC sheathed
Cadena de acero cementado cincado. Con
revestimiento de PVC

Finition/Finish/Acabado

PVC / PVC / PVC

Version/Option/Versión

563457 avec cadenas Mach 2 de 45 mm

563457 with padlock Mach2 45 mm

563457 – con candado Mach2 de 45 mm

Utilisation/Use/Utilización

Cycles - Barrières

Bicycles - Fences

Bicicletas - Barreras

Designation	Boite	Colis.	Prix	Sachet	Colis.	Prix	Brochable					Colis.	Prix
							France	Euro 1	Euro 2	Euro 3	Euro 4		
CHAÎNE gainée PVC Ø 8 long. 0,90 m	-	-	-	00908558	10	-	00508558	-	00592460 NS	-	-	5	-
CHAÎNE gainée PVC Ø 8 long. 1,20 m	-	-	-	00908560	10	-	00508560	-	00508560	-	-	5	-
CHAÎNE gainée PVC Ø 6 long. 0,60 m cadenas 45mm anse inox 2 clés	-	-	-	-	-	-	00563457	-	-	-	-	5	-

Antivol / UP

MOBILITE



NIVEAU DE SÉCURITÉ



GARANTIE



Acier gainé PVC

Acier gainé
PVC

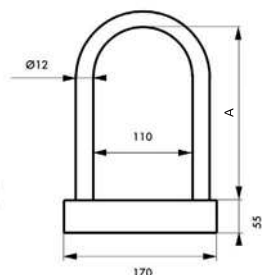

Hauteur : 245 mm

	580245	580320
A	195	255

Description/Description/Descripción

Corps acier zingué gainé PVC. Anse
acier cémenté nickelé gainé PVC. Double
verrouillage de l'anse. Mécanisme à disques.
2 clés plates en acier nickelé. Zinc plated
steel body PVC sheathed. Hardened nickel
plated steel shackle PVC sheathed. Double
locking. Disc mechanism. 2 nickel plated
steel keys.

Cuerpo de acero cincado con revestimiento
de PVC. Arco de acero cementado niquelado
con revestimiento de PVC. Doble cierre del
arco. Mecanismo de discos. 2 llaves de
acero niquelado.

Finition/Finish/Acabado

PVC bicolore / Bicolor PVC / PVC bicolor

Utilisation/Use/Utilización

Motos / Motobikes / Motos



X 2

Designation	Boite	Colis.	Prix	Sachet	Colis.	Prix	Brochable					Colis.	Prix
							France	Euro 1	Euro 2	Euro 3	Euro 4		
Antivol U gainée Ø 12 large : 170 mm - Haut : 245 mm	-	-	-	-	-	-	00580245	00580245	00580245	-	00580245 NS	5	-
Antivol U gainée Ø 12 large : 170 mm - Haut : 320 mm	-	-	-	-	-	-	00580320	00580320	00580320	-	-	5	-

NS Non stocké/Non-stored/Producto no estocado - ☐ Sur stock Europe Zone 1 et Zone 2, nous consulter pour délai d'approvisionnement - E Epuisement/Stock depletion/Agotamiento del stock

Antivol / BLOCK

MOBILITE



NIVEAU DE SÉCURITÉ



GARANTIE

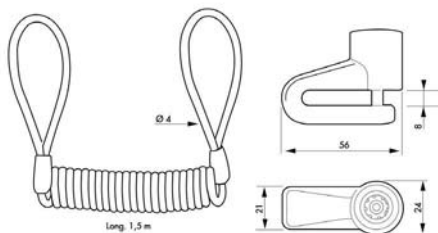

X 2

Description/Description/Descripción

Câble acier gainé PVC. Corps en alliage moulé. Mécanisme de sûreté à clé tubulaire. 2 clés tubulaires en laiton nickelé.

Steel PVC sheathed cable. Moulded alloy body. Safety mechanism with tubular keys. 2 nickel plated brass tubular keys.

Cable de acero con revestimiento de PVC. Cuerpo de aleación moldeada. Mecanismo de seguridad con llave tubular. 2 llaves tubulares de latón niquelado

Finition/Finish/Acabado

Laqué noir

Black lacquered

Lacado negro

Utilisation/Use/Utilización

Montage sur disque de frein

Fitted on disk-break

Montaje en disco de freno

Designation	Boite	Colis.	Prix	Sachet	Colis.	Prix	Brochable					Colis.	Prix
							France	Euro 1	Euro 2	Euro 3	Euro 4		
ANTIVOL SCOOTER Ø 4 mm avec câble long. 1,50m 2 clés	-	-	-	-	-	-	00277998	00293278	00292278	00294278	-	5	-

Antivol / BLOCK

MOBILITE



Antivol très efficace, pour scooter et moto.



NIVEAU DE SÉCURITÉ



GARANTIE

	Ø 5,5	Ø 10
A	58	55
B	75	98
C	49	80
D	30	35
ØE	5,5	10
F	7	9

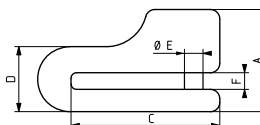
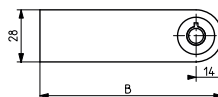

X 2

Description/Description/Descripción

Corps en alliage moulé. Mécanisme de sûreté à clé tubulaire. anse inox 2 clés tubulaires en laiton nickelé. *Moulded alloy body. Safety mechanism with tubular keys. 2 nickel plated brass tubular keys.*

Cuerpo de aleación moldeada. Mecanismo de seguridad con llave tubular. 2 llaves tubulares de latón niquelado

Finition/Finish/Acabado

Laqué jaune - rouge / *Yellow - red lacquered* / Lacado amarillo - rojo

Versión/Option/Versión

263607 - avec câble, mécanisme à disques, anse inox 2 clés. *263607 - with cable, discs mechanism, 2 keys.* 263607 - con cable, mecanismo de discos, 2 llaves.

Utilisation/Use/Utilización

Montage sur disque de frein : Ø 5,5 mm pour scooter - Ø 10 mm pour moto. *Fitted on disk-break : Ø 5,5 mm for scooter - Ø 10 mm for motorcycle.* / Montaje en disco de freno : Ø 5,5 mm para scooter - Ø 10 mm para moto.

Designation	Boite	Colis.	Prix	Sachet	Colis.	Prix	Brochable					Colis.	Prix
							France	Euro 1	Euro 2	Euro 3	Euro 4		
ANTIVOL SCOOTER Ø 5,5 mm	-	-	-	-	-	-	00263606	00293074 NS	00292074 NS	00294074	00295074 NS	5	-
ANTIVOL MOTO Ø 10 mm	-	-	-	-	-	-	00263610	00293073 NS	00292073 NS	00294073	-	5	-
ANTIVOL SCOOTER Ø 5,5 mm avec câble 2 clés à disque	-	-	-	-	-	-	00263607	00293075 NS	00292075 NS	00294075	-	5	-

Antivol / TWISTY MOBILITE



NIVEAU DE SÉCURITÉ



GARANTIE



Acier gainé PVC

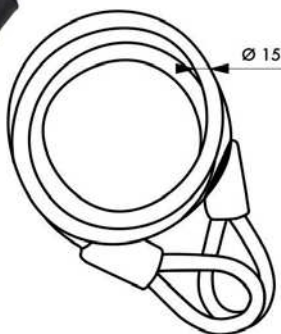

Description/Description/Descripción

Câble acier, gainé PVC
Steel cable, PVC sheathed.
Cable acero con revestimiento de PVC

Finition/Finish/Acabado

Couleurs assorties
Assorted colours
Colores surtidos

Utilisation/Use/Utilización

Cycles - Abris de jardin
Bicycles - Garden shelter
Bicicletas - Refugios de jardin

Longueur de câble 1,80 m

Designation	Boite	Colis.	Prix	Sachet	Colis.	Prix	Brochable					Colis.	Prix
							France	Euro 1	Euro 2	Euro 3	Euro 4		
CABLE Ø 15 long. 1,80 m	-	-	-	00915180	7	-	00515180	00592075	00592075	00592075	-	10	-

Antivol / STUNT MOBILITE



NIVEAU DE SÉCURITÉ



GARANTIE



Acier gainé PVC

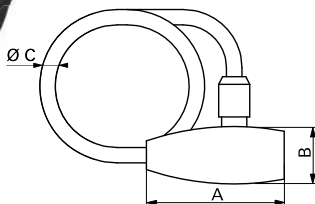

Description/Description/Descripción

Câble acier cémenté gainé PVC. 2 clés réversibles.
Case-hardened steel cable coated in PVC.
2 reversible keys.

Cable de acero cementado con funda PVC. 2 llaves reversibles.

Finition/Finish/Acabado

Noir
Black
Negro

Utilisation/Use/Utilización

Cycles - Motos - Barrières
Bicycles - Motorcycles - Fences
Bicicletas - Motos - Barreras



X 2

	000624	000625	000626
A	70,8mm	79,8mm	89,3mm
B	33mm	35mm	14,5mm
Ø C	12mm	18mm	25mm
LONG.	0,8m	1m	1,5m

Designation	Boite	Colis.	Prix	Sachet	Colis.	Prix	Brochable					Colis.	Prix
							France	Euro 1	Euro 2	Euro 3	Euro 4		
Antivol Stunt câble Ø12 long. 0,8 m	-	-	-	-	-	-	00500624	00500624	00500624	00500624	00500624	5	-
Antivol Stunt câble Ø18 long. 1,00 m	-	-	-	-	-	-	00500625	00500625	00500625	00500625	00500625	5	-
Antivol Stunt câble Ø25 long. 1,50 m	-	-	-	-	-	-	00500626	00500626	00500626	00500626	00500626	5	-

Ⓜ Non stocké/Non-stored/Producto no estocado - Ⓜ Sur stock Europe Zone 1 et Zone 2, nous consulter pour délai d'approvisionnement - Ⓜ Epuisement/Stock depletion/Agotamiento del stock

Antivol / SCORP

MOBILITE



NIVEAU DE SÉCURITÉ



GARANTIE



Acier gainé PVC

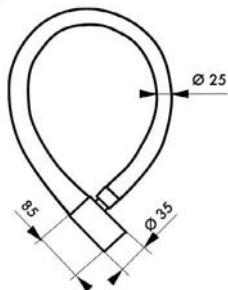

Longueur de câble : 0,85 m

Description/Description/Descripción

Câble acier, gainé PVC. Mécanisme à disques avec cache de protection. 2 clés plates en acier nickelé.

Steel cable with PVC sheath. Disc mechanism with protective cover. 2 nickel plated steel keys.

Cable de acero revestimiento de PVC.

Mecanismo de discos con tapa de protección. 2 llaves de acero niquelado.

Finition/Finish/Acabado

Noir

Black

Negro

Utilisation/Use/Utilización

Cycles - Motos - Barrières

Bicycles - Motorcycles - Fences

Bicicletas - Motos - Barreras



X 2

Designation	Boite	Colis.	Prix	Sachet	Colis.	Prix	Brochable					Colis.	Prix
							France	Euro 1	Euro 2	Euro 3	Euro 4		
ANTIVOL câble Ø 25 long. 0,85 m	-	-	-	-	-	-	00700267	00700267	00700267	-	-	5	-
ANTIVOL câble Ø 25 long. 1,00 m	-	-	-	-	-	-	00700268	00700268	00700268	-	-	5	-

Antivol / UP

MOBILITE



NIVEAU DE SÉCURITÉ



GARANTIE



Acier gainé PVC

Acier gainé PVC

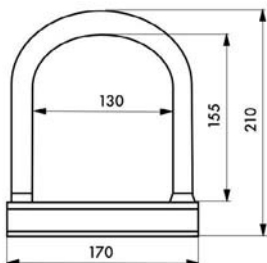

Description/Description/Descripción

Corps acier. Anse acier cémenté gainé PVC. Mécanisme à goupilles anti perçage. 3 clés sécurité en laiton nickelé (1 clé à LED).

Steel body. PVC sheathed steel shackle. Anti-drill pin mechanism. 3 nickel plated brass security keys (1 key with LED).

Cuerpo de acero. Arco de acero cementado con revestimiento de PVC. Mecanismo de pasadores antiladrado. 3 llaves seguridad de latón niquelado (1 llave con LED).

Finition/Finish/Acabado

Nickelé

Nickel plated.

Niquelado.

Utilisation/Use/Utilización

Cycles

Bicycles

Bicicletas



X 3

Designation	Boite	Colis.	Prix	Sachet	Colis.	Prix	Brochable					Colis.	Prix
							France	Euro 1	Euro 2	Euro 3	Euro 4		
Antivol U anse acier gainée Ø 16 larg: 170 mm, Haut : 210 mm	-	-	-	-	-	-	00580210	-	-	-	-	5	-

Non stocké/Non-stored/Producto no estocado - Sur stock Europe Zone 1 et Zone 2, nous consulter pour délai d'approvisionnement - Epuement/Stock depletion/Agotamiento del stock

Antivol / ZEBRA

MOBILITE



NIVEAU DE SÉCURITÉ



GARANTIE



Acier gainé PVC

Description/Description/Descripción

Antivol pliable. Support de fixation inclus. 3 clés réversibles (avec 1 clé à LED).

Folding anti-theft device. Fitting support included. 3 reversible keys (1 key with LED).

Antirrobo plegable. Soporte de fijación incluido. 3 llaves reversibles (1 llave con LED).

Finition/Finish/Acabado

Noir / Black / Negro

Versión/Option/Versión

A combinaison modifiable 4 viroles

Resettable combinations 4 dials mechanism

Combinación modifiable 4 virolas

Utilisation/Use/Utilización

Cycles / Bicycles / Bicicletas



X 3

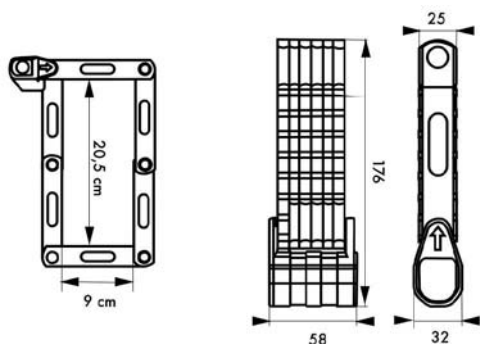

Designation	Boite	Colis.	Prix	Sachet	Colis.	Prix	Brochable					Colis.	Prix
							France	Euro 1	Euro 2	Euro 3	Euro 4		
Antivol Zebra à clé	-	-	-	-	-	-	00500620	00500620	00500620	00500620	00500620	5	-

Antivol / ZEBRA

MOBILITE



NIVEAU DE SÉCURITÉ



GARANTIE



Acier gainé PVC

Combinaison modifiable

Description/Description/Descripción

Antivol pliable. Support de fixation inclus. Mécanisme à combinaison à 4 viroles.

Folding anti-theft device. Fitting support included. Mechanism with 4 dial combination.

Antirrobo plegable. Soporte de fijación incluido. Mecanismo de combinación con 4 virolas.

Finition/Finish/Acabado

Noir / Black / Negro

Versión/Option/Versión

A clé

With key

Con llave

Utilisation/Use/Utilización

Cycles / Bicycles / Bicicletas



CODE MODIFIABLE

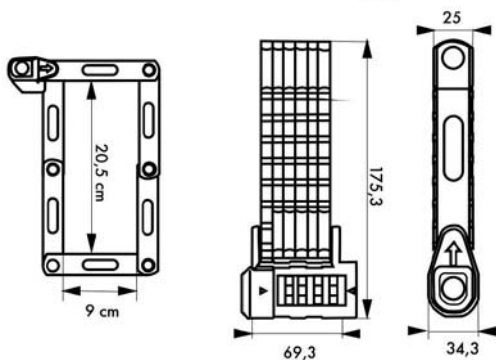

Designation	Boite	Colis.	Prix	Sachet	Colis.	Prix	Brochable					Colis.	Prix
							France	Euro 1	Euro 2	Euro 3	Euro 4		
Antivol Zebra à combinaison modifiable	-	-	-	-	-	-	00500621	00500621	00500621	00500621	00500621	5	-

Antivol / BIKER

MOBILITE

Acier gainé
PVC



NIVEAU DE SÉCURITÉ



GARANTIE

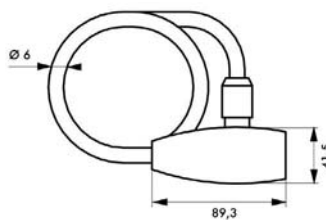

Longueur de câble : 0,9 m



X 2

Description/Description/Descripción

Chaîne acier cémenté gainée nylon. 2 clés réversibles.
Case-hardened steel chain coated in nylon. 2 reversible keys.

Cadena de acero cementado con funda nailon. 2 llaves reversibles.

Finition/Finish/Acabado

Noir - bande réfléchissante / Black - high visibility strip

Negro - banda reflectante

Version/Option/Versión

A combinaison modifiable 5 viroles

Resettable combinations 5 dials mechanism

Combinación modificable 5 virolas

Utilisation/Use/Utilización

Cycles - Motos - Barrières

Bicycles - Motorcycles - Fences

Bicicletas - Motos - Barreras

Designation	Boite	Colis.	Prix	Sachet	Colis.	Prix	Brochable					Colis.	Prix
							France	Euro 1	Euro 2	Euro 3	Euro 4		
Antivol BIKER chaîne Carré 6 long.0,9 m	-	-	-	-	-	-	00500623	00500623	00500623	00500623	00500623	5	-
Antivol BIKER chaîne Carré 6 long.0,9 m à combinaison modifiable	-	-	-	-	-	-	00500622	00500622	00500622	00500622	00500622	5	-

Antivol / SCORP

MOBILITE



NIVEAU DE SÉCURITÉ



GARANTIE



Acier gainé PVC

Antivol avec une résistance accrue grâce au blindage du câble.

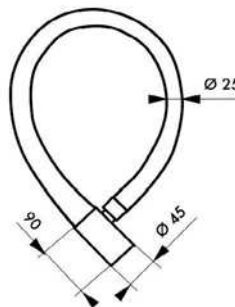

Longueur de câble : 0,85 m



X 2

Description/Description/Descripción

Câble blindé Ø 25 mm, gainé PVC. Mécanisme à disques avec cache de protection. 2 clés plates en acier nickelé.

Cable blindé Ø 25 mm, gainé PVC. Mécanisme à disques avec cache de protection. anse inox 2 clés plates en acier nickelé.

Cable de acero Ø 25 revestimiento de PVC. Mecanismo

de discos con tapa de protección. 2 llaves de acero niquelado.

Finition/Finish/Acabado

Noir / Black / Negro

Utilisation/Use/Utilización

Cycles - Motos - Barrières

Bicycles - Motorcycles - Fences

Bicicletas - Motos - Barreras

Designation	Boite	Colis.	Prix	Sachet	Colis.	Prix	Brochable					Colis.	Prix
							France	Euro 1	Euro 2	Euro 3	Euro 4		
ANTIVOL MOTO cable blindé Ø 25 long. 0,85 m	-	-	-	-	-	-	00703600	-	00703600	-	-	5	-
ANTIVOL MOTO cable blindé Ø 25 long. 1,20 m	-	-	-	-	-	-	00703700	-	00703700	-	-	5	-

Non stocké/Non-stored/Producto no estocado - Sur stock Europe Zone 1 et Zone 2, nous consulter pour délai d'approvisionnement - Epuement/Stock depletion/Agotamiento del stock

Antivol / LOOPS

MOBILITE



NIVEAU DE SÉCURITÉ



GARANTIE



Acier cémenté
gainé PVC

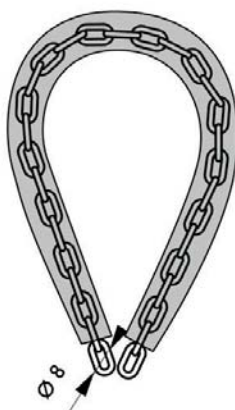

Description/Description/Descripción

Chaîne acier cémenté zingué. Gaine PVC
Hardened zinc plated steel chain. PVC sheathed

Cadena de acero cementado cincado. Con revestimiento de PVC

Finition/Finish/Acabado

PVC / PVC / PVC

Utilisation/Use/Utilización

Cycles - Barrières

Bicycles - Fences

Bicicletas - Barreras



X 3

Longueur de chaîne : 0,90 m

Designation	Boite	Colis.	Prix	Sachet	Colis.	Prix	Brochable					Colis.	Prix
							France	Euro 1	Euro 2	Euro 3	Euro 4		
CHAÎNE MOTO gainée PVC Ø 8 long. 0,90 m cadenas 3 clés	-	-	-	-	-	-	00568558	-	-	-	-	5	-

Antivol / LOOPS

MOBILITE



NIVEAU DE SÉCURITÉ



GARANTIE



Acier gainé nylon



Description/Description/Descripción

Chaîne acier cémenté zingué Carré 10 mm.
Gaine nylon. Avec cadenas, 2 clés

Case hardened zinc plated steel chain. Square 10 mm. Nylon sheath. With padlock, 2 keys

Cadena de acero cementado. cincado. Cuadrado 10 mm. Revestimiento de nylon.

Con candado , 2 llaves

Finition/Finish/Acabado

Noir / Black / Negro

Utilisation/Use/Utilización

Cycles - Motos - Barrières

Bicycles - Motorcycles - Fences

Bicicletas - Motos - Barreras



X 2

Longueur de chaîne : 0,90 m

Designation	Boite	Colis.	Prix	Sachet	Colis.	Prix	Brochable					Colis.	Prix
							France	Euro 1	Euro 2	Euro 3	Euro 4		
CHAÎNE gainée nylon 0,90 m 2 clés	-	-	-	-	-	-	00594461	00594461	00594461	00594461	00594461	5	-

⚠ Non stocké/Non-stored/Producto no estocado - 📦 Sur stock Europe Zone 1 et Zone 2, nous consulter pour délai d'approvisionnement - 📦 Epuisement/Stock depletion/Agotamiento del stock

Antivol / LOOPS

MOBILITE



NIVEAU DE SÉCURITÉ



GARANTIE

Acier gainé nylon

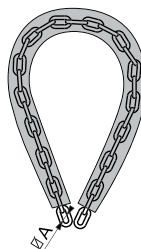

	745412	745415	745425	745315
ØA	10 mm	10 mm	10 mm	10 mm
LONG.	1,20 m	1,50 m	1,50 m	1,50 m

Description/Description/Descripción

Chaîne acier cimenté zingué Carré 10 mm. Gaine nylon.
Case hardened zinc plated steel chain Square 10 mm.
Nylon sheath.

Cadena de acero cementado cincado. Cuadrado 10 mm.
Revestimiento de nylon

Finition/Finish/Acabado

Noir / Black / Negro

Version/Option/Versión

745425 - avec cadenas de 60 mm, anse inox 2 clés, avec protection d'anse. 745315 - mécanisme à disques avec cache de protection, anse inox 2 clés.

745425 with 60 mm protected padlock, 2 keys. 745315 disc mechanism with protective cover

745425 con candado de 60 mm, arco protegido, 2 llaves. 745315 mecanismo de discos con tapa de protección

Utilisation/Use/Utilización

Cycles - Motos - Barrières

Bicycles - Motorcycles - Fences

Bicicletas - Motos - Barreras

Designation	Boîte	Colis.	Prix	Sachet	Colis.	Prix	Brochable					Colis.	Prix
							France	Euro 1	Euro 2	Euro 3	Euro 4		
CHAÎNE gainée nylon 1,20 m	-	-	-	00945412	5	-	00745412	00792077	00792077	00792077	-	5	-
CHAÎNE gainée nylon 1,50 m	-	-	-	00945415	5	-	00745415	00745415	-	00745415	-	5	-
CHAÎNE gainée nylon 1,50 m cadenas anse inox 2 clés	-	-	-	-	-	-	00745425	00792076	00792076	00792076	00795076	5	-
ANTIVOL chaîne gainée nylon 1,50 m anse inox 2 clés	-	-	-	-	-	-	00745315	00745315	00745315	00745315	-	5	-

Antivol / TÊTE D'ATTELAGE

MOBILITE

Acier zingué

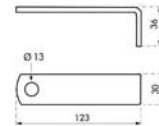
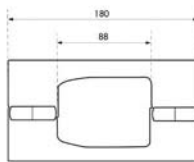
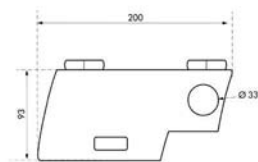

Antivol pour tête d'attelage remorque non attelée



GARANTIE

Description/Description/Descripción

Corps acier zingué. Possibilité de verrouillage par cadenas anse Ø 12 mm maxi.

Zinc plated steel body. Can be locked by a padlock with a Ø 12 mm shackle maximum

Cuerpo de acero cincado. Posibilidad de bloquear por candado con arco de Ø 12 mm máximo.

Finition/Finish/Acabado

Zingué / Zinc plated / Cincado

Utilisation/Use/Utilización

Antivol pour tête d'attelage remorque non attelée.

Antitheft for coupling head, non-coupled trailer

Antirrobo para cabezal de enganche, remorque en posición no acoplada.

Designation	Boîte	Colis.	Prix	Sachet	Colis.	Prix	Brochable					Colis.	Prix
							France	Euro 1	Euro 2	Euro 3	Euro 4		
Antivol tête d'attelage remorque cadenasable	00071031	1	-	-	-	-	00571031	-	-	00594031	-	5	-

Ⓜ Non stocké/Non-stored/Producto no estocado - Ⓜ Sur stock Europe Zone 1 et Zone 2, nous consulter pour délai d'approvisionnement - Ⓜ Epuisement/Stock depletion/Agotamiento del stock

Porte cadenas / ŒILLET ECO



GARANTIE

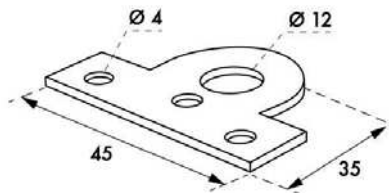

Description/Description/Descripción

Platine acier. Fixation par 3 vis (non fournies).
Steel plate. Fixing by 3 screws (not supplied).
Placa de acero. Montaje con 3 tornillos (no suministrados).

Finition/Finish/Acabado

Zingué
Zinc plated
Cincado

Version/Option/Versión

Conditionnement «Blister» x 4pièces
Blister pack x 4 pieces
Blister x 4 unidades

Designation	Boite	Colis.	Prix	Sachet	Colis.	Prix	Brochable					Colis.	Prix
							France	Euro 1	Euro 2	Euro 3	Euro 4		
Œillet porte cadenas	-	-	-	00987630	1	-	00187630	-	-	-	-	4	-

Porte cadenas / A PATTES ECO



GARANTIE

Ce porte cadenas peut se souder sur une porte métallique.

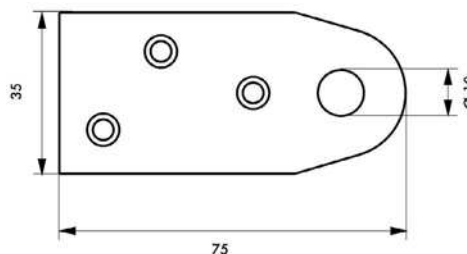

Description/Description/Descripción

Acier cémenté
Hardened steel
Acero cementado

Finition/Finish/Acabado

Zingué
Zinc plated
Cincado

Utilisation/Use/Utilización

Fermeture de coffres. Portes. Pose en feuillure.
Closing for safe. Doors. Suit on rebate door.
Cierre de cajas. Puertas. Instalación en galce

Designation	Boite	Colis.	Prix	Sachet	Colis.	Prix	Brochable					Colis.	Prix
							France	Euro 1	Euro 2	Euro 3	Euro 4		
PATTES acier cémenté zingué 2 pièces	00006912	10	-	00906912	20	-	00106912	00193202 NS	00192202 NS	00194202	-	10	-

NS Non stocké/Non-stored/Producto no estocado - S Sur stock Europe Zone 1 et Zone 2, nous consulter pour délai d'approvisionnement - E Epuisement/Stock depletion/Agotamiento del stock

Porte cadenas / A RECouvreMENT

ECO

Les vis de ce porte cadenas sont protégées en position cadenassée.

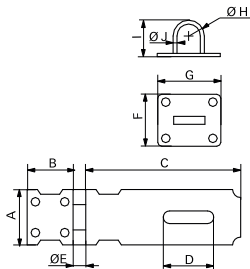

	75 mm	100 mm	125 mm	150 mm
A	28	35	42	42
B	21	30	40	40
C	70	96	120	145
D	24	32	34	34
E	7	8	10	10
F	27	33	38	38
G	32	40	45	45
ØH	12	15	20	20
I	20	23	28	28
ØJ	5	5	6	6



GARANTIE



Description/Description/Descripción

Acier. Recouvrement des vis en position fermée.

Steel. Screws covered in closed condition

Acero. Recubrimiento de los tornillos en posición cerrada.

Finition/Finish/Acabado

Zingué / Zinc plated / Cincado

Version/Option/Versión

Porte-cadenas 100 mm avec cadenas 40 mm

Hasp 100 mm with padlock 40 mm

Portacandados de 100 mm con candado de 40 mm

Utilisation/Use/Utilización

Fermeture de coffres. Portes. / Closing for safe. Doors

Cierre de cajas Puertas

Designation	Boite	Colis.	Prix	Sachet	Colis.	Prix	Brochable					Colis.	Prix
							France	Euro 1	Euro 2	Euro 3	Euro 4		
PORTE-CADENAS acier zingué 75 mm	00002139	10	-	00902139	20	-	00202139	00293430 NS	00292430 NS	-	-	10	-
PORTE-CADENAS acier zingué 100 mm	00002140	10	-	00902140	20	-	00202140	00293431 NS	00292431 NS	-	-	10	-
PORTE-CADENAS acier zingué 125 mm	00002150	10	-	00902150	20	-	00202150	00293062 NS	00292062 NS	00294062	-	10	-
PORTE-CADENAS acier zingué 150 mm	00002160	10	-	00902160	20	-	00202160	00293063 NS	00292063 NS	00294063	-	10	-
KIT PORTE-CADENAS zingué 100 mm cadenas 40mm 2 clés	-	-	-	-	-	-	00216035	00293066	00292066	00294066	-	10	-

Porte cadenas / A RECouvreMENT

ECO

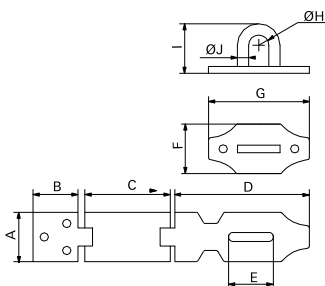

	100	120	140
A	22	22	30
B	20	20	33
C	40	40	50
D	60	80	85
E	20	20	30
F	22	22	30
G	45	45	55
ØH	9	9	14
I	22	22	28
ØJ	2	5	6



GARANTIE

Description/Description/Descripción

Acier embouti. Recouvrement des vis en position fermée.

Pressed steel. Screws covered in closed condition.

Acero embutido. Recubrimiento de los tornillos en posición cerrada

Finition/Finish/Acabado

Laqué noir / Black lacquered / Lacado negro

Utilisation/Use/Utilización

Fermeture de coffres. Portes.

Closing for safe. Doors

Cierre de cajas. Puertas.

Designation	Boite	Colis.	Prix	Sachet	Colis.	Prix	Brochable					Colis.	Prix
							France	Euro 1	Euro 2	Euro 3	Euro 4		
PORTE-CADENAS recouvrement acier 100 mm	00044100	10	-	00944100	20	-	00144100	00193061 NS	00192061 NS	00194061	-	10	-
PORTE-CADENAS recouvrement acier 120 mm	00044120	10	-	00944120	20	-	00144120	00193299 NS	00192229 NS	00194229	-	10	-
PORTE-CADENAS recouvrement acier 140 mm	00044140	10	-	00944140	20	-	00144140	00193230 NS	00192230 NS	00194230	-	10	-

NS Non stocké/Non-stored/Producto no estocado - S Sur stock Europe Zone 1 et Zone 2, nous consulter pour délai d'approvisionnement - E Epuisement/Stock depletion/Agotamiento del stock

Porte cadenas / A RECOUVREMENT PROTECT

Porte cadenas a finition decorative et pose facile.

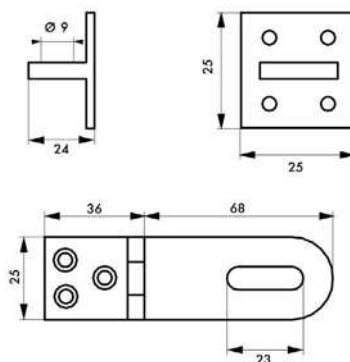

GARANTIE

Description/Description/Descripción

Aluminium. Recouvrement des vis en position fermée.
Aluminium. Screws covered in closed condition.
Aluminio. Recubrimiento de los tornillos en posición cerrada.

Finition/Finish/Acabado

Finition laiton
Brass finish
Acabado en laton

Version/Option/Versión

Chromé
Chrome plated
Cromado

Utilisation/Use/Utilización

Fermeture de coffres. Portes.
Closing for safe. Doors
Cierre de cajas Puertas

Designation	Boite	Colis.	Prix	Sachet	Colis.	Prix	Brochable					Colis.	Prix
							France	Euro 1	Euro 2	Euro 3	Euro 4		
PORTE-CADENAS finition laiton	-	-	-	00945300	20	-	00145300	00193065 NS	00192065 NS	00194065	-	10	-
PORTE-CADENAS finition chromé	-	-	-	00945301	20	-	00145301	00193066 NS	00192066 NS	00194066	-	10	-

Porte cadenas / RENFORCE PROTECT

Haute protection pour ce porte cadenas spécialement conçu contre l'arrachement.

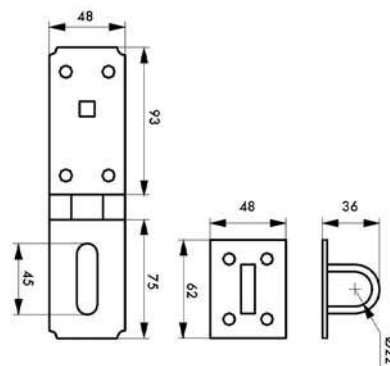

GARANTIE

Description/Description/Descripción

Acier. Fixation par boulon TRCC traversant.
Steel. Security with head square neck bolt.
Seguridad mediante perno TRC pasante

Finition/Finish/Acabado

Zingué / Zinc plated / Cincado

Utilisation/Use/Utilización

Fermeture de coffres. Portes épaisseur 30 à 50 mm.
Closing for safe. Doors thickness 30 to 50 mm.
Cierre de cajas. Puertas de un espesor de 30 a 50 mm.

Designation	Boite	Colis.	Prix	Sachet	Colis.	Prix	Brochable					Colis.	Prix
							France	Euro 1	Euro 2	Euro 3	Euro 4		
PORTE-CADENAS renforcé 90 mm	-	-	-	00901970	20	-	00201970	00293064 NS	00292064 NS	00294064	-	10	-
PORTE-CADENAS renforcé 90 mm avec cadenas 40 mm	-	-	-	-	-	-	-	00293065 NS	00292065 NS	00294065	-	10	-

NS Non stocké/Non-stored/Producto no estocado - M Sur stock Europe Zone 1 et Zone 2, nous consulter pour délai d'approvisionnement - E Epuisement/Stock depletion/Agotamiento del stock

Porte cadenas / A RECOUVREMENT RESIST

Haute protection pour ce porte cadenas adaptable sur les portes coulissantes et les portes décalées.

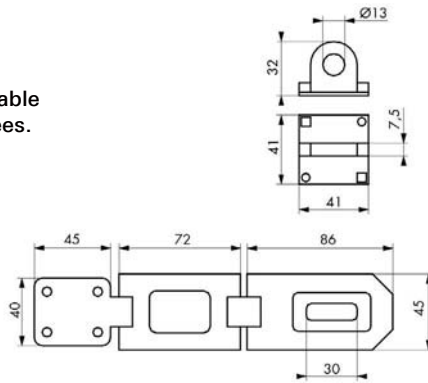

10
ans

GARANTIE



Description/Description/Descripción

Acier renforcé cimenté. Recouvrement des vis en position fermée
Hardened steel. Screws covered in closed condition
Acero reforzado cementado. Recubrimiento de los tornillos en posición cerrada

Finition/Finish/Acabado

Nickelé. / *Nickel plated.* / Niquelado.
Utilisation/Use/Utilización
Protection renforcée pour tous types de fermetures.
Heavy duty security for tough uses.
Protección reforzada para todo tipo de cierres.

Designation	Boîte	Colis.	Prix	Sachet	Colis.	Prix	Brochable					Colis.	Prix
							France	Euro 1	Euro 2	Euro 3	Euro 4		
PORTE-CADENAS 160 mm	-	-	-	00910750	20	-	00210750	00293401 NSI	00292401 NSI	00294401	-	10	-
PORTE-CADENAS 200 mm	-	-	-	00910850	20	-	00210850	00293402 NSI	00292402 NSI	00294408	-	10	-

Porte cadenas / POUR GRILLE RESIST

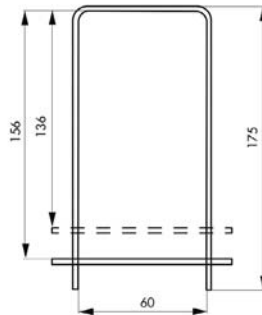
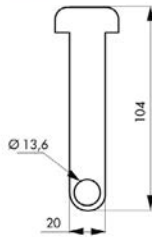

10
ans

GARANTIE

Description/Description/Descripción

Acier cimenté. Verrouillage ajustable.
Hardened steel. Adjustable locking.
Acero cementado. Bloqueo ajustable.

Utilisation/Use/Utilización

Protection pour tous types de grilles
Heavy duty security for tough uses
Protección reforzada para todo tipo de cierres

Finition/Finish/Acabado

Zingué / *Zinc coated* / Cincado

Designation	Boîte	Colis.	Prix	Sachet	Colis.	Prix	Brochable					Colis.	Prix
							France	Euro 1	Euro 2	Euro 3	Euro 4		
PORTE-CADENAS pour grille	00013899	1	-	00913899	5	-	00413899	00493899 NSI	00492899 NSI	00494899	-	-	-

NS Non stocké/Non-stored/Producto no estocado - S Sur stock Europe Zone 1 et Zone 2, nous consulter pour délai d'approvisionnement - E Epuisement/Stock depletion/Agotamiento del stock

Porte cadenas Renforcé / A RECouvreMENT RESIST

10
ans

GARANTIE

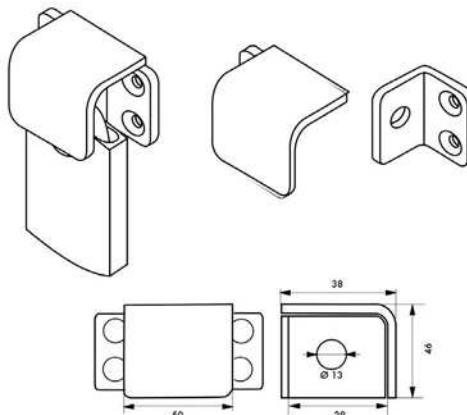

Description/Description/Descripción

Acier renforcé cémenté. Recouvrement des vis en position fermée.

Hardened steel. Screws covered in closed condition.
Acero reforzado cementado. Recubrimiento de los tornillos en posición cerrada

Finition/Finish/Acabado

Noir / Black / Negro

Utilisation/Use/Utilización

Protection renforcée pour tous types de fermetures
Heavy duty security for tough uses
Protección reforzada para todo tipo de cierres

Designation	Boite	Colis.	Prix	Sachet	Colis.	Prix	Brochable					Colis.	Prix
							France	Euro 1	Euro 2	Euro 3	Euro 4		
PORTE-CADENAS renforcé	00013927	1	-	-	-	-	-	-	-	-	-	-	-
Porte-cadenas pour porte coulissante Ouverture à gauche	00013928	1	-	-	-	-	-	-	-	-	-	-	-

Porte cadenas Renforcé / A RECouvreMENT RESIST

10
ans

GARANTIE

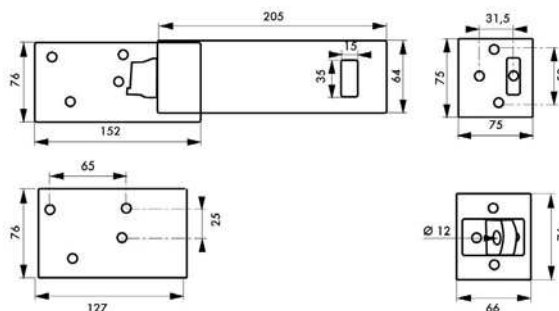

Description/Description/Descripción

Acier renforcé cémenté. Recouvrement des vis en position fermée.

Hardened steel. Screws covered in closed condition.
Acero reforzado cementado. Recubrimiento de los tornillos en posición cerrada

Finition/Finish/Acabado

Noir / Black / Negro

Utilisation/Use/Utilización

Protection renforcée pour tous types de fermetures
Heavy duty security for tough uses
Protección reforzada para todo tipo de cierres

Designation	Boite	Colis.	Prix	Sachet	Colis.	Prix	Brochable					Colis.	Prix
							France	Euro 1	Euro 2	Euro 3	Euro 4		
PORTE-CADENAS renforcé	-	-	-	-	-	-	00413909	00413309	00413309	00413309	-	1	-

Porte cadenas / RENFORCE RESIST

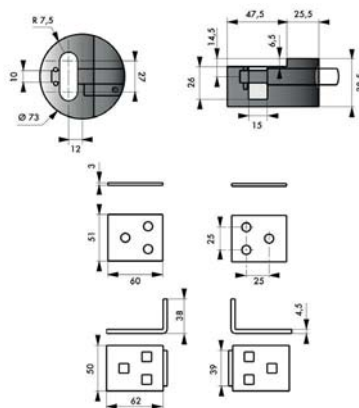

GARANTIE



Description/Description/Descripción

Porte-cadenas acier cémenté. Montage par vis TRCC et contre plaque. Cadenas acier cémenté nickelé. Mécanisme à goupilles interchangeable. 2 clés. *Hardened steel hasp. Head square neck bolts fixing with strengthening plate. Hardened nickel plated steel padlock with rekeyable brass cylinder. 2 keys.* Portacandados de acero cementado. Montaje mediante tornillos TRC y contraplaca. Candado de acero cementado niquelado. Mecanismo de pasadores

Finition/Finish/Acabado

Chromé / Nickel plated / Latón pulido

Version/Option/Versión

Avec ou sans cadenas 040350 - avec vis TRCC de 60 mm.

With or without padlock 040350 - with Head square neck bolts fixing 60 mm

Con o sin candado 040350 - con tornillos TRC 60 mm

Utilisation/Use/Utilización

Protection renforcée pour tous types de fermetures

Heavy duty security for tough uses

Protección reforzada para todo tipo de cierres

Designation	Boite	Colis.	Prix	Sachet	Colis.	Prix	Brochable					Colis.	Prix
							France	Euro 1	Euro 2	Euro 3	Euro 4		
KIT PORTE-CADENAS + CADENAS Ø 73 mm - 2 clés	00040350	10	-	-	-	-	00240350	00293406 NS	00292406 NS	00294406	-	2	-
PORTE-CADENAS	00030350	10	-	-	-	-	00230350	00293403 NS	00292403 NS	00294403	-	10	-

Boite à clé / A COMBINAISON PROTECT

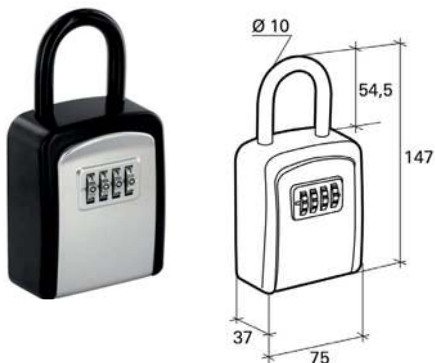

NIVEAU DE SÉCURITÉ



GARANTIE

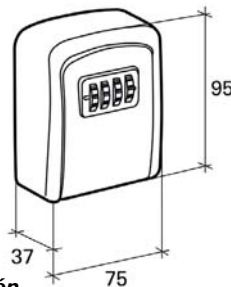

CODE MODIFIABLE

Description/Description/Descripción

Corps alliage moulé. Mécanisme à 4 viroles. Combinaison modifiable. *Moulded alloy body. Mechanism with 4 dials. Resettable combination*

Cuerpo de aleación moldeado. Mecanismo de 4 virolas. Combinación modifi cable.

Finition/Finish/Acabado

Noir - gris / Black - grey / Negro - gris.

Version/Option/Versión

Avec anse

With shackle

Con arco.

Utilisation/Use/Utilización

Stockage de clés / Key storage.

Almacenamiento de llaves.

Designation	Boite	Colis.	Prix	Sachet	Colis.	Prix	Brochable					Colis.	Prix
							France	Euro 1	Euro 2	Euro 3	Euro 4		
Boite à clé avec anse à combinaison	00071035	1	-	-	-	-	00371035	00393295 NS	00392295 NS	00394295	-	5	-
Boite à clé à combinaison	00071036	1	-	-	-	-	00371036	00393296 NS	00392296 NS	00394296	-	5	-

NS Non stocké/Non-stored/Producto no estocado - Sur stock Europe Zone 1 et Zone 2, nous consulter pour délai d'approvisionnement - E Epuisement/Stock depletion/Agotamiento del stock

Boite à clé / A COMBINAISON PROTECT



NIVEAU DE SÉCURITÉ



GARANTIE



CODE MODIFIABLE

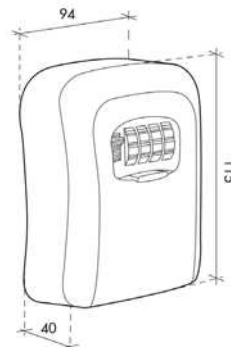

Description/Description/Descripción

Corps alliage moulé. Mécanisme à 4 viroles.
Combinaison modifiable.
Moulded alloy body. Mechanism with 4 dials. Resettable combination
Cuerpo de aleación moldeado. Mecanismo de 4 virolas.
Combinación modifi cable.

Finition/Finish/Acabado

Noir / Black / Negro
Utilisation/Use/Utilización
Stockage de clés
Key storage.
Almacenamiento de llaves.

Designation	Boite	Colis.	Prix	Sachet	Colis.	Prix	Brochable					Colis.	Prix
							France	Euro 1	Euro 2	Euro 3	Euro 4		
Boite à clé murale à combinaison	00071029	1	-	-	-	-	00371029	00393293 NS	00392293 NS	00394293	-	5	-

Boite à clé / A COMBINAISON PROTECT

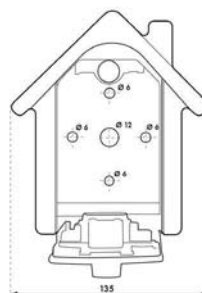
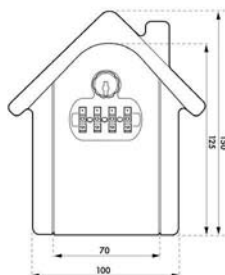

NIVEAU DE SÉCURITÉ



GARANTIE



CODE MODIFIABLE

Description/Description/Descripción

Coprs alliage moulé. Mécanisme à 4 viroles.
Combinaison modifiable. Ouverture par bouton tournant.
2 clés de secours.
Moulded alloy body. Mechanism with 4 dials. Resettable combination. Opening by turning knob. 2 emergency keys.
Cuerpo de aleación. Mecanismo de 4 virolas.
Combinación modifi cable. Apertura mediante un pomo.
2 llaves de emergencia.

Finition/Finish/Acabado

Noir satiné
Black satin
Negro satinado
Utilisation/Use/Utilización
Stockage de clés
Key storage.
Almacenamiento de llaves.

Designation	Boite	Colis.	Prix	Sachet	Colis.	Prix	Brochable					Colis.	Prix
							France	Euro 1	Euro 2	Euro 3	Euro 4		
Boite à clés «maison»	00071037	20	-	-	-	-	-	-	-	-	-	-	-

Boite à clé / A COMBINAISON PROTECT



NIVEAU DE SÉCURITÉ



GARANTIE



CODE
MODIFIABLE

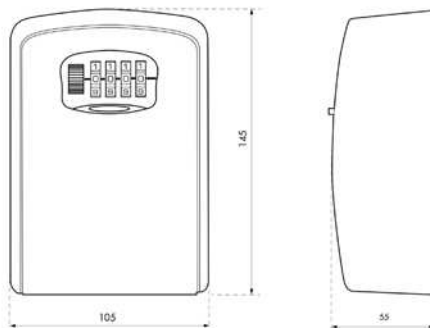

Description/Description/Descripción

Corps alliage moulé. Mécanisme à 4 viroles.
Combinaison modifiable. Joint d'étanchéité.
Moulded alloy body. Mechanism with 4 dials. Resettable combination. Tightness seal.
Cuerpo de aleación moldeado. Mecanismo de 4 virolas.
Combinación modifi cable. Junta de estanqueidad.

Finition/NoirBlack

Finition/ / Finish/ / Acabado
Utilisation/Use/Utilización
Stockage de clés
Key storage.
Almacenamiento de llaves.

Designation	Boite	Colis.	Prix	Sachet	Colis.	Prix	Brochable					Colis.	Prix
							France	Euro 1	Euro 2	Euro 3	Euro 4		
Boite à clé murale combinaison modifi able GM	00071030	1	-	-	-	-	00371030	00393638 NSI	00392638 NSI	00394638	-	5	-

Boite à clé / A COMBINAISON PROTECT



NIVEAU DE SÉCURITÉ



GARANTIE



CODE
MODIFIABLE

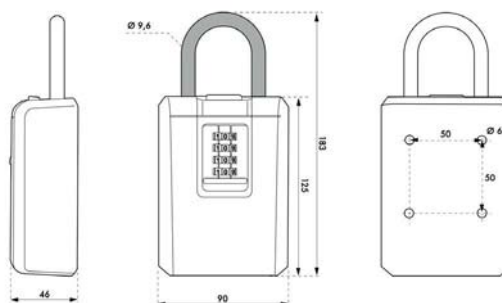

Description/Description/Descripción

Corps alliage moulé. Mécanisme à 4 viroles.
Combinaison modifiable. Fixation murale ou utilisation possible avec anse acier amovible.
Moulded alloy body. 4 dials mechanism. Resettable combination. Wall mounting or use with removable steel shackle.
Cuerpo de aleación. Mecanismo de 4 virolas.
Combinación modifi cable. montaje en la pared o uso con arco de acero extraíble

Finition/Finish/Acabado

Noir - gris
Black - grey
Negro - gris.
Utilisation/Use/Utilización
Stockage de clés
Key storage.
Almacenamiento de llaves.

Designation	Boite	Colis.	Prix	Sachet	Colis.	Prix	Brochable					Colis.	Prix
							France	Euro 1	Euro 2	Euro 3	Euro 4		
Boite à clés modulable à combinaison	00071038	20	-	-	-	-	00471038	-	-	-	-	1	-

NSI Non stocké/Non-stored/Producto no estocado - Sur stock Europe Zone 1 et Zone 2, nous consulter pour délai d'approvisionnement - E Epuisement/Stock depletion/Agotamiento del stock

Coffret de sécurité / A CABLE PROTECT

Coffret idéal pour stocker
en toute sécurité

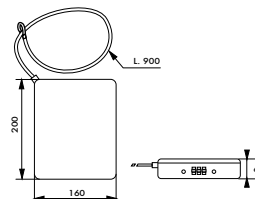

Description/Description/Descripción

Corps acier embouti. Mécanisme à 3 viroles.
Combinaison modifiable. Résistant à l'eau.
Pressed steel body. Mechanism with 3 dials. Resettable combination. Water resistant.
Caja de acero embutido. Mecanismo de 3 virolas.
Combinación modificable. Resistente al agua.

Finition/Finish/Acabado

Noir mat / Black matt / Negro mate

Utilisation/Use/Utilización

Mise en sécurité des clés, argent, passeport, ...
Safe storage keys, money, passport, ...
Puesta en seguridad de llaves, dinero, pasaporte, ...

Designation	Boite	Colis.	Prix	Sachet	Colis.	Prix	Brochable					Colis.	Prix
							France	Euro 1	Euro 2	Euro 3	Euro 4		
Coffret de sécurité à combinaison modifiable avec câble	00071027	1	-	-	-	-	00371027	00393027 NS	00392027 NS	00394027	-	-	-

Boite à clé / A COMBINAISON PROTECT



	071005	071006	071019
	75	75	75
	130	130	130
	47	47	47
	42	-	-
	40	-	-
	10	-	-



Description/Description/Descripción

Corps alliage moulé. Mécanisme à 4 viroles.
Combinaison modifiable. Joint d'étanchéité.
Moulded alloy body. Mechanism with 4 dials. Resettable combination. Tightness seal.
Cuerpo de aleación moldeado. Mecanismo de 4 virolas.
Combinación modificable. Junta de estanqueidad.

Finition/Finish/Acabado

Noir / Black / Negro

Option/Versión

Fixation murale, avec anse, avec câble.
Wall fitted, with shackle and cable.
Fijación a la pared, con arco, con cable.
Utilisation/Use/Utilización
Stockage de clés
Use Key storage
Almacenamiento de llaves

Designation	Boite	Colis.	Prix	Sachet	Colis.	Prix	Brochable					Colis.	Prix
							France	Euro 1	Euro 2	Euro 3	Euro 4		
Boîte à clé avec anse - à combinaison	00071005	1	-	-	-	-	00471005	00493307 NS	00492307 NS	00494307	-	5	-
Boîte à clé murale à combinaison	00071006	1	-	-	-	-	00371006	00393292 NS	00393292 NS	00394292	-	5	-
Boîte à clé à câble à combinaison	00071019	1	-	-	-	-	00471019	00493306 NS	00492306 NS	00494306	-	5	-

Boîte à clé / A ENCASTRER PROTECT



NIVEAU DE SÉCURITÉ



GARANTIE



Boîte à clé équipée d'un cylindre à clé plate réversible

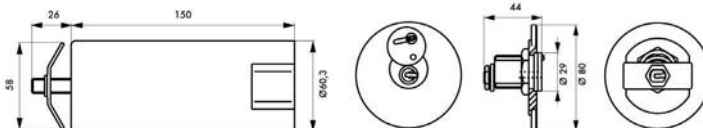

Description/Description/Descripción

Cylindre laiton. Mécanisme à 6 goupilles et filtres. Couvercle laiton. Cache entrée laiton à fermeture automatique. Tube inox. Mécanisme protégé contre le vandalisme. 2 clés.

Brass cylinder. Mechanism with 6 pins and filters. Brass cover. Automatically closing brass scutcheon. Stainless steel tube. Vandal-resistant mechanism. 2 keys.

Cilindro de latón. Mecanismo de 6 pasadores y filtros.

Tapa de latón. Tapa de entrada de latón con cierre automático. Mecanismo protegido contra el vandalismo. 2 llaves.

Finition/Finish/Acabado

Poli, chromé / Polished, chromium plated / Pulido, cromado

Utilisation/Use/Utilización

Boîte à clés tubulaire démontable

Removable tubular key case

Caja de llaves tubular desmontable

Designation	Boîte	Colis.	Prix	Sachet	Colis.	Prix	Brochable					Colis.	Prix
							France	Euro 1	Euro 2	Euro 3	Euro 4		
Boîte à clé à encastrer	00012231	1	-	-	-	-	-	-	-	-	-	-	-

Boîte à clé / CP PROTECT



NIVEAU DE SÉCURITÉ



GARANTIE



Boîte à clé avec cylindre interchangeable, possibilité d'installation en s'entrouvant

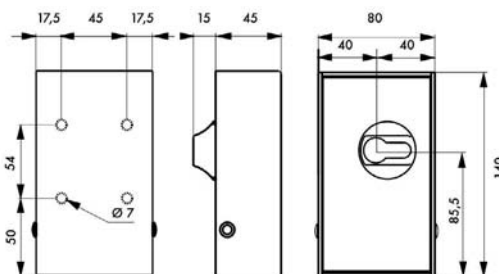

Description/Description/Descripción

Coffre cambré en acier zingué. Couvercle abattant. 2 accroches clés. 1/2 cylindre profilé européen. 30 x 10 mm, non livré.

Raised case made of zinc plated steel. Pivoting cover. 2 keys hangers. European profile cylinder 30x10mm, not supplied.

Aja curvada de acero cincado. Tapa abatible. 2 ganchos de llave. Medio cilindro perfilado europeo de 30 x 10 mm, no suministrado.

Finition/Finish/Acabado

Laqué epoxy blanc

White epoxy lacquered

Lacado epoxy blanco

Utilisation/Use/Utilización

Mise en sécurité des clés

Safe storage Key

Puesta en seguridad de llaves

Designation	Boîte	Colis.	Prix	Sachet	Colis.	Prix	Brochable					Colis.	Prix
							France	Euro 1	Euro 2	Euro 3	Euro 4		
Boîte à clé à cylindre profilé	00012232	1	-	-	-	-	-	-	-	-	-	-	-

Câble de sécurité / ORDI PROTECT

DISPONIBLE JUSQU'À
ÉPUISEMENT DES STOCKS



GARANTIE



CODE
MODIFIABLE

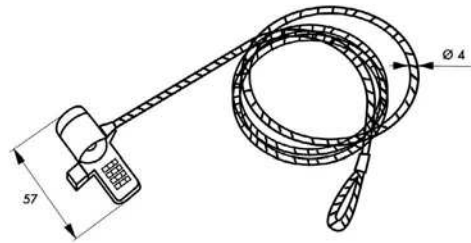
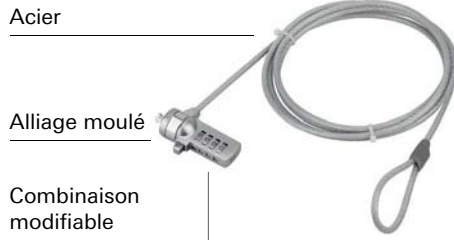

Longueur de câble : 1m 80

Description/Description/Descripción

Corps alliage moulé. Câble acier Ø 4 mm long. 1,80m gainé PVC. Mécanisme à 4 viroles. Combinaison modifiable.

Moulded alloy body. Steel cable Ø 4 mm length 1,80 m protected by a PVC shell. 4 dial mechanism. Resettable combination.

Cuerpo de aleación moldeada. Cable de acero Ø 4 mm longitud 1,80 m con revestimiento de PVC. Mecanismo con 4 virolas. Combinación modificable.

Finition/Finish/Acabado

Nickelé satin

Satin nickel

Niquel satinado

Utilisation/Use/Utilización

Antivol pour ordinateur portable

Laptop lock

El robo del ordenador portátil

Designation	Boite	Colis.	Prix	Sachet	Colis.	Prix	Brochable					Colis.	Prix
							France	Euro 1	Euro 2	Euro 3	Euro 4		
Câble antivol ORDI pour ordinateur portable long. 1,80 m combinaison modifiable	-	-	-	-	-	-	00371004 E	00393291 E NS	00392291 E NS	00394291 E	00395291 E NS	10	-

Suppléments / POUR CADENAS

Designation	Boite	Colis.	Prix	Sachet	Colis.	Prix	Brochable					Colis.	Prix
							France	Euro 1	Euro 2	Euro 3	Euro 4		
LUBRIFIANT poudre graphite 95 ml pour cylindre	00096005	10	-	00996005	20	-	00296005	00293177	00292177	00294177	-	10	-
Bloc de sûreté sur numéro pour cadenas à billes	00096004	1	-	-	-	-	-	-	-	-	-	-	-
Supplément pour entr'ouverture (pour quantité < 50 pièces)	00063001	-	-	-	-	-	-	-	-	-	-	-	-
Supplément pour entr'ouverture hors standard (pour quantité < 50 pièces)	00063991	-	-	-	-	-	-	-	-	-	-	-	-
Supplément pour numéro imposé (pour quantité < 50 pièces)	00063091	-	-	-	-	-	-	-	-	-	-	-	-
*Minoration pour clé non fournie (prix net par clé)	00063003	-	-	-	-	-	-	-	-	-	-	-	-
Supplément pour gravure cadenas	00063013	-	-	-	-	-	-	-	-	-	-	-	-
Supplément pour combinaisons ouvrant sur passe-partout cadenas MACH 3 / FEDERAL	00063004	-	-	-	-	-	-	-	-	-	-	-	-
Clé passe-partout cadenas SM/ FEDERAL	00063005	-	-	-	-	-	-	-	-	-	-	-	-
Numérotage du N° de clé sur corps de cadenas	00063006	-	-	-	-	-	-	-	-	-	-	-	-
Numérotage du corps sur code	00063007	-	-	-	-	-	-	-	-	-	-	-	-
Numérotage de la clé sur code	00063008	-	-	-	-	-	-	-	-	-	-	-	-
Supplément pour anse laiton ou inox sur cadenas SM	00063009	-	-	-	-	-	-	-	-	-	-	-	-
Supplément pour mise sur passe-général cadenas TRANSIT 2	00094003	-	-	-	-	-	-	-	-	-	-	-	-
Supplément clé prisonnière pour cadenas NAUTIC 55-65-80	00068003	-	-	-	-	-	-	-	-	-	-	-	-



DANGER

**DO NOT
OPERATE**

2 1/2"-5"
(63mm-127mm)

This Lockout Device May
Only be Removed by:

Name: _____
Dept: _____
Expected Completion: _____

DANGER
VERROUILLÉ
NE PAS
ENLEVER

Cette étiquette
This tag
Esta etiqueta solo debe ser retirada por:

Nom / Name / Nombre: **POCLET**
Dépt / Dept / Departamento: **MAINTENANCE**
Valable jusqu'au / Valid until / Válido hasta: **14/09/17**

Industrie et consignation







CADENAS INDUSTRIE	179	CADENAS DE CONSIGNATION	184
CONSIGNATION GROUPE DE PERSONNES	200	BOÎTE DE CONSIGNATION	203
CONSIGNATION ÉLECTRIQUE	204	CONSIGNATION ORGANES DE COMMANDES	214
CONSIGNATION POUR FLUIDES	217	CONSIGNATION PNEUMATIQUE	223
CONSIGNATION MÉCANIQUE	224	STOCKAGE	227
SAC DE TRANSPORT	230	ETIQUETTE DE CONSIGNATION	
KIT	236	BOÎTE À CLÉS	242
SCELLÉ	243		

*Sommaire détaillé par produit
page suivante*











Industrie et consignation



CADENAS INDUSTRIE

Cadenas d'artillerie		179
407 CP à cylindre profilé		181
CP à cylindre profilé		182
740 - 740 P		183
741 - 740 P		183

CADENAS DE CONSIGNATION

Cadenas corps laiton anse inox		184
Corps ABS acier inox / nylon		185
Corps ABS anse inox / nylon		189
Corps ABS acier inox / nylon		191
Corps ABS câble inox		192
Corps ABS câble acier		193
Anneau de clé		196
Bumper pour cadenas		198
Coque pour cadenas		199

















CONSIGNATION GROUPE DE PERSONNES

Mâchoire acier inoxydable		200
Mâchoire aluminium		201
Mâchoire nylon		202





BOÎTE DE CONSIGNATION

Boîte de collecte de clés		203
---------------------------	---	-----





CONSIGNATION ÉLECTRIQUE





Verrouillage Mini disjoncteur 11 mm		204
Verrouillage Mini disjoncteur 12,7 mm		204
Verrouillage universel		205
Verrouillage universel 2 positions		206
Verrouillage double		206
Verrouillage mini disjoncteur 20 mm		207
Verrouillage interrupteur 220/280V		207
Verrouillage à levier moyen		208
Verrouillage pour levier 10 à 17 mm		208
Verrouillage ajustable		209
Verrouillage à levier large		210
Boîtier moulé 3 trous		210
Verrouillage interrupteur 380/600V		211
Verrouillage disjoncteur à bascule		211
Consignation de section		212
Verrouillage disjoncteur magnéto-thermique PM		213

CONSIGNATION ORGANES DE COMMANDES

Bloque bouton		214
Consignation arrêt d'urgence		215
Sac de consignation		216
Consignation de prise		216

CONSIGNATION POUR FLUIDES





Consignation de vanne à volant		217
Consignation de vanne ajustable		218
Consignation de vanne 1/4 de tour		218
Consignation de vanne 1/4 de tour métal		219

Consignation de vanne 1/4 de tour PP		219
Consignation de vanne 1/4 de tour		220
Consignation de vanne papillon		221
Consignation universelle pour vanne		221
Consignation de vanne de gaz		222

CONSIGNATION PNEUMATIQUE

Consignation 4 cadenas		223
Consignation nylon		223

CONSIGNATION MÉCANIQUE

Cable ajustable 0,295 m		224
Cable ajustable 0,60 m		225
Cable ajustable 1,80 m		225
Cable ajustable 2 m		225
Cable ajustable 4 m		226

STOCKAGE

Armoire pour cadenas		227
Armoire de consignation		228
Station de stockage		229

SAC DE TRANSPORT

Sac de transport		230
Trousse de transport		230
Sac banane		230
Sac		230
Sac banane		230
Ratelier de transport		231

ETIQUETTE DE CONSIGNATION

Etiquette plastifiée 3 langues		234
Etiquette PP		234
Support tag échaffaudage		235





KIT

Kit maintenance électrique	236
Kit cadenas	240
Kit maintenance plomberie	241

BOÎTE À CLÉS

Boîte à clé de secours		242
------------------------	---	-----

SCELLÉ

Plomb scellé		243
Plomb scellé cadenas		244
Scellé métallique		245
Scellé métallique lockseal		247





GARANTIE



X 1



00010290



00012290



Description/Description/Descripción

Corps laiton massif. Anse acier zingué. Condamnation par triangle. 1 Clé (sauf conditionnement boîte, livré sans clé).

Solid brass body. Zinc plated steel shackle. Closing by triangle. 1 Key (excluding packaging box, delivered without key).

Cuerpo de latón macizo. Arco de acero cincado. Condenación por triángulo. 1 Llave (excepto caja de embalaje entrega sin llave).

Finition/Finish/Acabado

Laiton
Brass
Latón

Version/Option/Versión

Anse laiton. Talon droit ou coudé. Vis triangle. Vis demi-lune. Vis carré.

Brass shackle. Straight or bended heel. Triangular screw. Semi-round screw. Square screw.

Arco de latón. Talón recto o acodado. Tornillo triángulo. Tornillo media luna. Tornillo cuadrado.

Utilisation/Use/Utilización

Intérieur : anse acier. Extérieur : anse laiton.

Indoor: steel shackle. Outdoor: brass shackle.

Interior : arco de acero. Exterior : arco de latón.

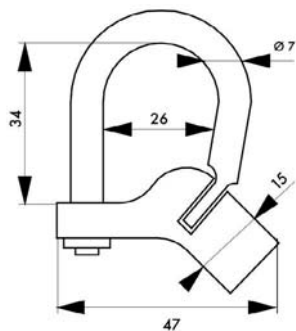

00010290

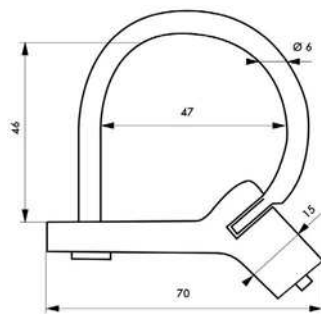

00012290

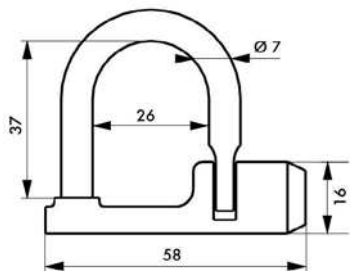

00010390

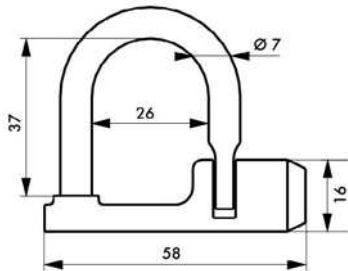

00011390

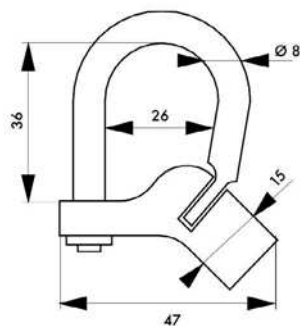

00011290

Designation	Boite	Colis.	Prix	Sachet	Colis.	Prix	Brochable					Colis.	Prix
							France	Euro 1	Euro 2	Euro 3	Euro 4		
CADENAS 29 à talon coudé anse acier triangle 5 mm	00010290	10	-	00910290	10	-	00110290	-	-	-	-	10	-
CADENAS 129 à talon coudé anse acier vis demi-lune	00010291	10	-	-	-	-	-	-	-	-	-	-	-
CADENAS 329 à talon droit anse acier triangle 5 mm	00010390	10	-	-	-	-	-	-	-	-	-	-	-
CADENAS 29 C à talon coudé anse laiton triangle 5 mm	00011290	10	-	-	-	-	-	-	-	-	-	-	-
CADENAS 129 C à talon coudé anse laiton vis demi-lune	00011291	10	-	-	-	-	-	-	-	-	-	-	-
CADENAS 329 C à talon droit anse laiton triangle 5 mm	00011390	10	-	-	-	-	-	-	-	-	-	-	-
CADENAS 629 C GM à talon coudé anse laiton triangle 5 mm	00012290	10	-	-	-	-	-	-	-	-	-	-	-
CLÉ pour cadenas triangulaire 5 mm	00010000	10	-	-	-	-	-	-	-	-	-	-	-
CLÉ pour cadenas demi-lune	00010001	10	-	-	-	-	-	-	-	-	-	-	-
CLÉ pour cadenas carré	00010002	10	-	-	-	-	-	-	-	-	-	-	-
CLÉ triangle 4 mm	00010004	10	-	-	-	-	-	-	-	-	-	-	-
CLÉ triangle 9 mm laiton	00013923	10	-	-	-	-	-	-	-	-	-	-	-
CLÉ triangle 11 mm laiton	00013924	10	-	-	-	-	-	-	-	-	-	-	-
CLÉ triangle 14 mm laiton	00013925	10	-	-	-	-	-	-	-	-	-	-	-

☒ Non stocké/Non-stored/Productos no estocados - ☑ Sur stock Europe Zone 1 et Zone 2, nous consulter pour délai d'approvisionnement - ☒ Epuement/Stock depletion/Agotamiento del stock

Cadenas d'ARTILLERIE

ECO



GARANTIE



X 1

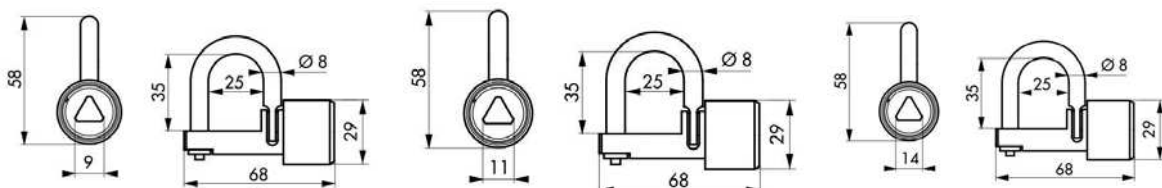

Description/Description/Descripción

Corps laiton massif. Anse laiton. Condamnation par triangle. Livré sans clé

Solid brass body. Brass shackle. Closing by triangle. Cuerpo de latón macizo. Arco de latón. Condenación por triángulo.

Finition/Finish/Acabado

Laiton

Brass

Latón

Utilisation/Use/Utilización

Extérieur

Outdoor

Exterior

Designation	Boite	Colis.	Prix	Sachet	Colis.	Prix	Brochable					Colis.	Prix
							France	Euro 1	Euro 2	Euro 3	Euro 4		
CADENAS talon droit anse laiton triangle 9 mm	00011394	10	-	-	-	-	-	-	-	-	-	-	-
CADENAS talon droit anse laiton triangle 11 mm	00011395	10	-	-	-	-	-	-	-	-	-	-	-
CADENAS talon droit anse laiton triangle 14 mm	00011396	10	-	-	-	-	-	-	-	-	-	-	-
CLÉ triangle 9 mm	00013923	10	-	-	-	-	-	-	-	-	-	-	-
CLÉ triangle 11 mm	00013924	10	-	-	-	-	-	-	-	-	-	-	-
CLÉ triangle 14 mm	00013925	10	-	-	-	-	-	-	-	-	-	-	-

⚠ Non stocké/Non-stored/Producto no estocado - 📦 Sur stock Europe Zone 1 et Zone 2, nous consulter pour délai d'approvisionnement - 📦 Epuisement/Stock depletion/Agotamiento del stock



GARANTIE

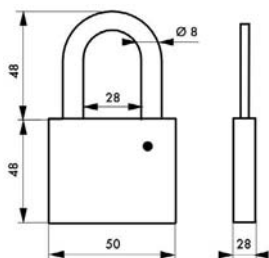

Description/Description/Descripción

Corps laiton. Anse acier cémenté. Verrouillage par le panneton du cylindre. Trou d'écoulement d'eau. Fourni avec accessoires de montage du cylindre. A équiper d'un cylindre profilé 30x10 à panneton orientable (non fourni).
 Compact brass body. Stainless steel shackle. Locking by driver cam. Safety device against drawing. Anti corrosion. Flow through water hole. Provided with driver and retaining sleeve. Use an adjustable drive cam cylinder 30x10 mm (not included).

Cuerpo de latón macizo. Arco de acero cementado. Bloqueo por la paletón del cilindro. Orificio de circulación de agua. Suministrado con accesorios de montaje del cilindro. Para cilindro perfilado europeo 30x10 mm ajustable (no incluido).

Finition/Finish/Acabado

Laiton
 Brass
 Latón pulido

Utilisation/Use/Utilización

Industrie
 Industry
 Industria

Designation	Boite	Colis.	Prix	Sachet	Colis.	Prix	Brochable					Colis.	Prix
							France	Euro 1	Euro 2	Euro 3	Euro 4		
CADENAS CP 50mm - sans cylindre	00099407	1	-	-	-	-	-	-	-	-	-	-	-

Non stocké/Non-stored/Producto no estocado - Sur stock Europe Zone 1 et Zone 2, nous consulter pour délai d'approvisionnement - Epuement/Stock depletion/Agotamiento del stock



GARANTIE

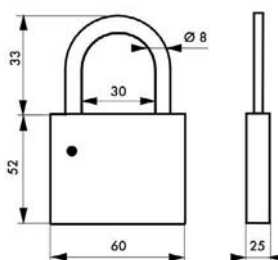

Description/Description/Descripción

Corps laiton. Anse inox. Verrouillage par le panneton du cylindre. Haute résistance contre l'arrachement. Anti-corrosion. Trou d'écoulement d'eau. Fourni avec accessoires de montage du cylindre. A équiper d'un cylindre profilé 30x10mm à panneton orientable (non fourni).

Compact brass body. Stainless steel shackle. Locking by driver cam. Safety device against drawing. Anti corrosion. Flow through water hole. Provided with driver and retaining sleeve. Use an adjustable drive cam cylinder 30x10 mm (not included).

Cuerpo de latón macizo. Arco de acero inoxidable. Bloqueo por la paletón del cilindro. Alta resistencia contra el arrancamiento. Anti corrosión. Orificio de circulación de agua. Suministrado con accesorios de montaje del cilindro. Para cilindro perfilado europeo 30x10 mm ajustable (no incluido).

Finition/Finish/Acabado

Laiton
Brass
Latón pulido

Utilisation/Use/Utilización

Industrie
Industry
Industria

Designation	Boite	Colis.	Prix	Sachet	Colis.	Prix	Brochable					Colis.	Prix
							France	Euro 1	Euro 2	Euro 3	Euro 4		
CADENAS CP anse inox sans cylindre	00099601 NS	1	-	-	-	-	-	-	-	-	-	-	-
Cadenas CP anse haute inox sans cyl. E	00099602 NS	1	-	-	-	-	-	-	-	-	-	-	-
1/2 CYLINDRE 30 x10 mm nickelé panneton orientable 4 clés	00018739 NS	1	-	-	-	-	-	-	-	-	-	-	-



GARANTIE

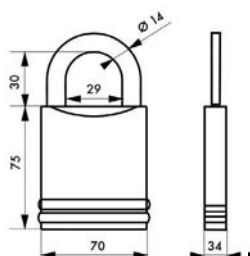

Description/Description/Descripción

Corps acier cémenté + traitement PVD (procédé de métallisation contre la corrosion). Anse molybdène + traitement PVD. A équiper d'un cylindre profilé européen Atlantic ou Atlantic M 38x10mm avec panneton orientable à 7H.

Case-hardened steel body + PVD treatment (steel rust-proof treatment) Molybdenum shackle + PVD treatment. To be fitted with a profiled European cylinder Atlantic or Atlantic M with orientable bit 38x10mm at 7H.

Cuerpo de acero cementado + tratamiento PVD (procedimiento de metalización contra la corrosión). Arco de molibdeno + tratamiento PVD. Equipar con un cilindro de perfil europeo Atlantic o Atlantic M con paletón orientable 38x10 mm 7H.

Finition/Finish/Acabado

Nickel satin

Nickel satin

Níquel satinado

Utilisation/Use/Utilización

Chantier

Construction sites

Obras de construcción

Designation	Boite	Colis.	Prix	Sachet	Colis.	Prix	Brochable					Colis.	Prix
							France	Euro 1	Euro 2	Euro 3	Euro 4		
CADENAS 740 sans cylindre	00099740	10	-	-	-	-	-	-	-	-	-	-	-
CADENAS 740P sans cylindre	00099741	10	-	-	-	-	-	-	-	-	-	-	-

Cadenas de CONSIGNATION RESIST



GARANTIE



X 1



Laiton



Laiton

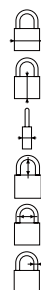

Goup.

006422	006460
007422	007460
40	40
42	42
16	16
22	60
22	22
5	5
5	5

Description/Description/Descripción

Corps laiton monobloc. Anse acier inoxydable.
Mécanisme à goupilles. Double ancrage par billes. Trou d'écoulement d'eau. Clé « prisonnière » : Le cadenas doit être fermé pour reprendre la clé. 1 clé laiton.

Compact brass body. Stainless steel shackle. Pin mechanism. Double bolt locking. Flow through water hole. The padlock must be closed to remove the key. 1 brass key.

Cuerpo de latón monobloque. Arco de acero inoxidable. Mecanismo de pasadores. Doble anclaje mediante pestillos. Orificio de circulación de agua. El candado tiene que estar cerrado para recoger la llave. 1 llave de latón.

Finition/Finish/Acabado

Laiton poli
Polished brass
Latón pulido

Version/Option/Versión

Avec bumper
With bumper
Con bumper

Utilisation/Use/Utilización

Consignation
Safety lock-out
Consignación

Designation	Boite	Colis.	Prix	Sachet	Colis.	Prix	Brochable					Colis.	Prix
							France	Euro 1	Euro 2	Euro 3	Euro 4		
CADENAS 40 mm anse inox Ø 5	00006422 NS	10	-	-	-	-	-	-	-	-	-	-	-
CADENAS 40 mm anse 1/2 haute inox Ø 5	00006460 NS	10	-	-	-	-	-	-	-	-	-	-	-
CADENAS 40 mm avec bumper anse inox Ø 5	00007422 NS	10	-	-	-	-	-	-	-	-	-	-	-
CADENAS 40 mm avec bumper anse 1/2 haute inox Ø 5	00007460 NS	10	-	-	-	-	-	-	-	-	-	-	-

NS Non stocké/Non-stored/Producto no estocado - ☑ Sur stock Europe Zone 1 et Zone 2, nous consulter pour délai d'approvisionnement - ☒ Epuisement/Stock depletion/Agotamiento del stock

Cadenas de CONSIGNATION RESIST



GARANTIE



X 1



Références :
005338-005525
005538-005576
005376

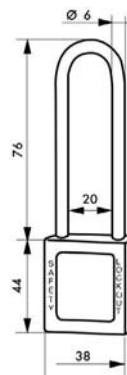
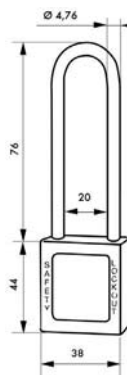
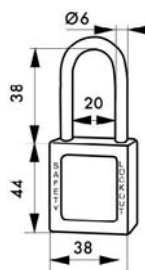
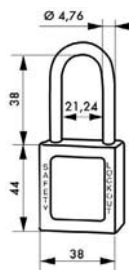
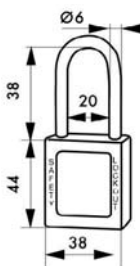
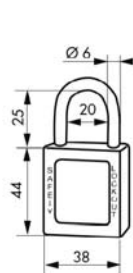

Description/Description/Descripción

Corps ABS non conducteur. Anse acier inoxydable.

Mécanisme à goupilles. Double ancrage. Clé « prisonnière » : le cadenas doit être fermé pour reprendre la clé. 1 clé laiton. Livré avec un jeu d'étiquettes.

Non-conductive ABS lock body. Stainless steel shackle.

Pin mechanism. Double locking. The padlock must be closed to remove the key. 1 brass key. Supplied with a set of labels.

Cuerpo ABS no conductor. Arco de acero inoxidable.

Mecanismo de pasadores. Doble anclaje. Llave "detenida": El candado tiene que estar cerrado para recoger la llave. 1 llave de latón. Entregado con un conjunto de etiquetas.

Finition/Finish/Acabado

Rouge, orange, jaune, vert, Bleu, noir, violet, blanc, marron

Red, orange, yellow, green, blue, black, Purple, white, brown

Rojo, naranja, amarillo, Verde, azul, negro, Púrpura, blanco, marrón

Version/Option/Versión

Anse nylon protection diélectrique, anti-étincelles.

Cadenas sur même combinaison. Mise sur passe (PG, PGPP). Clé libre (sur demande). Option : sans retenue de clé et fermeture automatique.

Nylon shackle : Dielectric protection, anti-sparking

Arco de nilón protección dieléctrica anti chispas

Utilisation/Use/Utilización

Cadenas résistant aux chocs, à la chaleur, à la corrosion. Idéal pour les applications électriques.

Impact, heat and corrosion resistance. Idéal for electrical applications

Impacto, calor y resistencia a la corrosión. Ideal para las aplicaciones eléctricas

Designation	Boite	Colis.	Prix	Sachet	Colis.	Prix	Brochable					Colis.	Prix
							France	Euro 1	Euro 2	Euro 3	Euro 4		
CADENAS 25 mm anse inox Ø 6 ROUGE	005525RD 	1	-	-	-	-	-	-	-	-	-	-	-
CADENAS 25 mm anse inox Ø 6 ORANGE	005525OR 	1	-	-	-	-	-	-	-	-	-	-	-
CADENAS 25 mm anse inox Ø 6 JAUNE	005525YL 	1	-	-	-	-	-	-	-	-	-	-	-

Non stocké/Non-stored/Producto no estocado - Sur stock Europe Zone 1 et Zone 2, nous consulter pour délai d'approvisionnement - Epuisement/Stock depletion/Agotamiento del stock

Cadenas de CONSIGNATION

RESIST

Designation	Boite	Colis.	Prix	Sachet	Colis.	Prix	Brochable					Colis.	Prix
							France	Euro 1	Euro 2	Euro 3	Euro 4		
CADENAS 25 mm anse inox Ø 6 VERT	005525GN NS	1	-	-	-	-	-	-	-	-	-	-	-
CADENAS 25 mm anse inox Ø 6 BLEU	005525BL NS	1	-	-	-	-	-	-	-	-	-	-	-
CADENAS 25 mm anse inox Ø 6 NOIR	005525BK NS	1	-	-	-	-	-	-	-	-	-	-	-
CADENAS 25 mm anse inox Ø 6 VIOLET	005525VT NS	1	-	-	-	-	-	-	-	-	-	-	-
CADENAS 25 mm anse inox Ø 6 BLANC	005525WT NS	1	-	-	-	-	-	-	-	-	-	-	-
CADENAS 25 mm anse inox Ø 6 MARRON	005525BN NS	1	-	-	-	-	-	-	-	-	-	-	-
CADENAS 38 mm anse nylon Ø 6 ROUGE	005238RD NS	1	-	-	-	-	-	-	-	-	-	-	-
CADENAS 38 mm anse nylon Ø 6 ORANGE	005238OR NS	1	-	-	-	-	-	-	-	-	-	-	-
CADENAS 38 mm anse nylon Ø 6 JAUNE	005238YL NS	1	-	-	-	-	-	-	-	-	-	-	-
CADENAS 38 mm anse nylon Ø 6 VERT	005238GN NS	1	-	-	-	-	-	-	-	-	-	-	-
CADENAS 38 mm anse nylon Ø 6 BLEU	005238BL NS	1	-	-	-	-	-	-	-	-	-	-	-
CADENAS 38 mm anse nylon Ø 6 NOIR	005238BK NS	1	-	-	-	-	-	-	-	-	-	-	-
CADENAS 38 mm anse nylon Ø 6 VIOLET	005238VT NS	1	-	-	-	-	-	-	-	-	-	-	-
CADENAS 38 mm anse nylon Ø 6 BLANC	005238WT NS	1	-	-	-	-	-	-	-	-	-	-	-
CADENAS 38 mm anse nylon Ø 6 MARRON	005238BN NS	1	-	-	-	-	-	-	-	-	-	-	-
CADENAS 38 mm anse inox Ø 4,76 ROUGE	005338RD NS	1	-	-	-	-	-	-	-	-	-	-	-
CADENAS 38 mm anse inox Ø 4,76 ORANGE	005338OR NS	1	-	-	-	-	-	-	-	-	-	-	-
CADENAS 38 mm anse inox Ø 4,76 JAUNE	005338YL NS	1	-	-	-	-	-	-	-	-	-	-	-
CADENAS 38 mm anse inox Ø 4,76 VERT	005338GN NS	1	-	-	-	-	-	-	-	-	-	-	-
CADENAS 38 mm anse inox Ø 4,76 BLEU	005338BL NS	1	-	-	-	-	-	-	-	-	-	-	-
CADENAS 38 mm anse inox Ø 4,76 NOIR	005338BK NS	1	-	-	-	-	-	-	-	-	-	-	-
CADENAS 38 mm anse inox Ø 4,76 VIOLET	005338VT NS	1	-	-	-	-	-	-	-	-	-	-	-
CADENAS 38 mm anse inox Ø 4,76 BLANC	005338WT NS	1	-	-	-	-	-	-	-	-	-	-	-
CADENAS 38 mm anse inox Ø 4,76 MARRON	005338BN NS	1	-	-	-	-	-	-	-	-	-	-	-
CADENAS 38 mm anse inox Ø 6 ROUGE	005538RD NS	1	-	-	-	-	-	-	-	-	-	-	-
CADENAS 38 mm anse inox Ø 6 ORANGE	005538OR NS	1	-	-	-	-	-	-	-	-	-	-	-
CADENAS 38 mm anse inox Ø 6 JAUNE	005538YL NS	1	-	-	-	-	-	-	-	-	-	-	-

NS Non stocké/Non-stored/Producto no estocado - ☑ Sur stock Europe Zone 1 et Zone 2, nous consulter pour délai d'approvisionnement - ☒ Epuisement/Stock depletion/Agotamiento del stock

Cadenas de CONSIGNATION

RESIST



Designation	Boite	Colis.	Prix	Sachet	Colis.	Prix	Brochable					Colis.	Prix
							France	Euro 1	Euro 2	Euro 3	Euro 4		
CADENAS 38 mm anse inox Ø 6 VERT	005538GN NS	1	-	-	-	-	-	-	-	-	-	-	-
CADENAS 38 mm anse inox Ø 6 BLEU	005538BL NS	1	-	-	-	-	-	-	-	-	-	-	-
CADENAS 38 mm anse inox Ø 6 NOIR	005538BK NS	1	-	-	-	-	-	-	-	-	-	-	-
CADENAS 38 mm anse inox Ø 6 VIOLET	005538VT NS	1	-	-	-	-	-	-	-	-	-	-	-
CADENAS 38 mm anse inox Ø 6 BLANC	005538WT NS	1	-	-	-	-	-	-	-	-	-	-	-
CADENAS 38 mm anse inox Ø 6 MARRON	005538BN NS	1	-	-	-	-	-	-	-	-	-	-	-
CADENAS 38 mm anse haute inox Ø 4,76 ROUGE	005376RD NS	1	-	-	-	-	-	-	-	-	-	-	-
CADENAS 38 mm anse haute inox Ø 4,76 ORANGE	005376OR NS	1	-	-	-	-	-	-	-	-	-	-	-
CADENAS 38 mm anse haute inox Ø 4,76 JAUNE	005376YL NS	1	-	-	-	-	-	-	-	-	-	-	-
CADENAS 38 mm anse haute inox Ø 4,76 VERT	005376GN NS	1	-	-	-	-	-	-	-	-	-	-	-
CADENAS 38 mm anse haute inox Ø 4,76 BLEU	005376BL NS	1	-	-	-	-	-	-	-	-	-	-	-
CADENAS 38 mm anse haute inox Ø 4,76 NOIR	005376BK NS	1	-	-	-	-	-	-	-	-	-	-	-
CADENAS 38 mm anse haute inox Ø 4,76 VIOLET	005376VT NS	1	-	-	-	-	-	-	-	-	-	-	-
CADENAS 38 mm anse haute inox Ø 4,76 BLANC	005376WT NS	1	-	-	-	-	-	-	-	-	-	-	-
CADENAS 38 mm anse haute inox Ø 4,76 MARRON	005376BN NS	1	-	-	-	-	-	-	-	-	-	-	-
CADENAS 38 mm anse haute inox Ø 6 ROUGE	005576RD NS	1	-	-	-	-	-	-	-	-	-	-	-
CADENAS 38 mm anse haute inox Ø 6 ORANGE	005576OR NS	1	-	-	-	-	-	-	-	-	-	-	-
CADENAS 38 mm anse haute inox Ø 6 JAUNE	005576YL NS	1	-	-	-	-	-	-	-	-	-	-	-
CADENAS 38 mm anse haute inox Ø 6 VERT	005576GN NS	1	-	-	-	-	-	-	-	-	-	-	-
CADENAS 38 mm anse haute inox Ø 6 BLEU	005576BL NS	1	-	-	-	-	-	-	-	-	-	-	-
CADENAS 38 mm anse haute inox Ø 6 noir	005576BK NS	1	-	-	-	-	-	-	-	-	-	-	-
CADENAS 38 mm anse haute inox Ø 6 VIOLET	005576VT NS	1	-	-	-	-	-	-	-	-	-	-	-
CADENAS 38 mm anse haute inox Ø 6 BLANC	005576WT NS	1	-	-	-	-	-	-	-	-	-	-	-
CADENAS 38 mm anse haute inox Ø 6 MARRON	005576BN NS	1	-	-	-	-	-	-	-	-	-	-	-
Lot d'étiquettes pour 50 cadenas FR/GB/ES	00091317 NS	1	-	-	-	-	-	-	-	-	-	-	-
Lot d'étiquettes pour 50 cadenas GB/PL/RU	00091318 NS	1	-	-	-	-	-	-	-	-	-	-	-
Lot d'étiquettes pour 50 cadenas GB/RO/HU	00091319 NS	1	-	-	-	-	-	-	-	-	-	-	-

NS Non stocké/Non-stored/Producto no estocado - Sur stock Europe Zone 1 et Zone 2, nous consulter pour délai d'approvisionnement - E Epuisement/Stock depletion/Agotamiento del stock

Cadenas de CONSIGNATION RESIST



GARANTIE



X 1

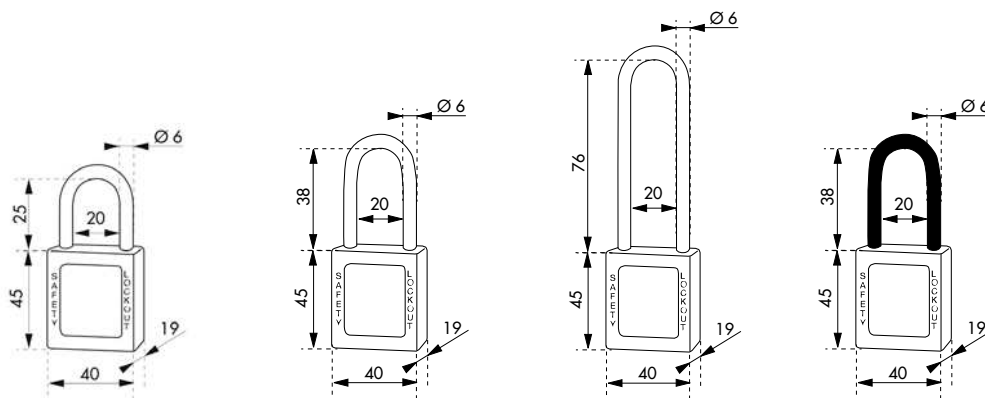

Description/Description/Descripción

Corps ABS non conducteur. Anse acier trempé.
Mécanisme à goupilles. Double ancrage. Clé
« prisonnière » : le cadenas doit être fermé pour
repandre la clé. 1 clé. Livré avec un jeu d'étiquettes.
*Non-conductive ABS lock body. Nickel plated steel
shackle. Pin mechanism. Double locking. The padlock must
be closed to remove the key. 1 key. Supplied with a set of
labels.*

Cuerpo ABS no conductor. Arco de acero templado.
Mecanismo de pasadores. Doble anclaje. Llave
"detenida": El candado tiene que estar cerrado para
recoger la llave. 1 llave. Entregado con un conjunto de
etiquetas.

Finition/Finish/Acabado

Rouge, orange, jaune, vert, bleu, noir
Red, orange, yellow, green, blue, black
Rojo, naranja, amarillo, verde, azul, negro

Version/Option/Versión

Anse nylon protection diélectrique, anti-étincelles.
Cadenas sur même combinaison.

Nylon shackle: Dielectric protection, anti-sparking
Arco de nilón protección dieléctrica anti chispas

Utilisation/Use/Utilización

Cadenas résistant aux chocs, à la chaleur, à la corrosion.
Idéal pour les applications électriques.

*Impact, heat and corrosion resistance. Idéal for electrical
applications*

Impacto, calor y resistencia a la corrosión. Ideal para las
aplicaciones eléctricas

Cadenas de CONSIGNATION

RESIST

Designation	Boite	Colis.	Prix	Sachet	Colis.	Prix	Brochable					Colis.	Prix
							France	Euro 1	Euro 2	Euro 3	Euro 4		
CADENAS 40 mm anse acier Ø 6 X 25 mm ROUGE	00091170	1	-	-	-	-	-	-	-	-	-	-	-
CADENAS 40 mm anse acier Ø 6 X 25 mm ORANGE	00091171	1	-	-	-	-	-	-	-	-	-	-	-
CADENAS 40 mm anse acier Ø 6 X 25 mm JAUNE	00091172	1	-	-	-	-	-	-	-	-	-	-	-
CADENAS 40 mm anse acier Ø 6 X 25 mm VERT	00091173	1	-	-	-	-	-	-	-	-	-	-	-
CADENAS 40 mm anse acier Ø 6 X 25 mm BLEU	00091174	1	-	-	-	-	-	-	-	-	-	-	-
CADENAS 40 mm anse acier Ø 6 X 25 mm NOIR	00091175	1	-	-	-	-	-	-	-	-	-	-	-
CADENAS 40 mm anse acier Ø 6 X 76 mm ROUGE	00091240	1	-	-	-	-	-	-	-	-	-	-	-
CADENAS 40 mm anse acier Ø 6 X 76 mm ORANGE	00091241	1	-	-	-	-	-	-	-	-	-	-	-
CADENAS 40 mm anse acier Ø 6 X 76 mm JAUNE	00091242	1	-	-	-	-	-	-	-	-	-	-	-
CADENAS 40 mm anse acier Ø 6 X 76 mm VERT	00091243	1	-	-	-	-	-	-	-	-	-	-	-
CADENAS 40 mm anse acier Ø 6 X 76 mm BLEU	00091244	1	-	-	-	-	-	-	-	-	-	-	-
CADENAS 40 mm anse acier Ø 6 X 76 mm NOIR	00091245	1	-	-	-	-	-	-	-	-	-	-	-
CADENAS 40 mm anse acier Ø 6 X 38 mm ROUGE	00091260	1	-	-	-	-	-	-	-	-	-	-	-
CADENAS 40 mm anse acier Ø 6 X 38 mm ORANGE	00091261	1	-	-	-	-	-	-	-	-	-	-	-
CADENAS 40 mm anse acier Ø 6 X 38 mm JAUNE	00091262	1	-	-	-	-	-	-	-	-	-	-	-
CADENAS 40 mm anse acier Ø 6 X 38 mm VERT	00091263	1	-	-	-	-	-	-	-	-	-	-	-
CADENAS 40 mm anse acier Ø 6 X 38 mm BLEU	00091264	1	-	-	-	-	-	-	-	-	-	-	-
CADENAS 40 mm anse acier Ø 6 X 38 mm NOIR	00091265	1	-	-	-	-	-	-	-	-	-	-	-
CADENAS 40 mm anse nylon Ø 6 X 38 mm ROUGE	00091270	1	-	-	-	-	-	-	-	-	-	-	-
CADENAS 40 mm anse nylon Ø 6 X 38 mm ORANGE	00091271	1	-	-	-	-	-	-	-	-	-	-	-
CADENAS 40 mm anse nylon Ø 6 X 38 mm JAUNE	00091272	1	-	-	-	-	-	-	-	-	-	-	-
CADENAS 40 mm anse nylon Ø 6 X 38 mm VERT	00091273	1	-	-	-	-	-	-	-	-	-	-	-
CADENAS 40 mm anse nylon Ø 6 X 38 mm BLEU	00091274	1	-	-	-	-	-	-	-	-	-	-	-
CADENAS 40 mm anse nylon Ø 6 X 38 mm NOIR	00091275	1	-	-	-	-	-	-	-	-	-	-	-
Lot d'étiquettes pour 50 cadenas FR/GB/ES	00091317	1	-	-	-	-	-	-	-	-	-	-	-
Lot d'étiquettes pour 50 cadenas GB/PL/RU	00091318	1	-	-	-	-	-	-	-	-	-	-	-
Lot d'étiquettes pour 50 cadenas GB/RO/HU	00091319	1	-	-	-	-	-	-	-	-	-	-	-

☐ Non stocké/Non-stored/Producto no estocado - ☑ Sur stock Europe Zone 1 et Zone 2, nous consulter pour délai d'approvisionnement - ⓘ Epuisement/Stock depletion/Agotamiento del stock



Cadenas de CONSIGNATION RESIST



GARANTIE



X 1



Références :
005790-005715
005624



005790BL



005624RD

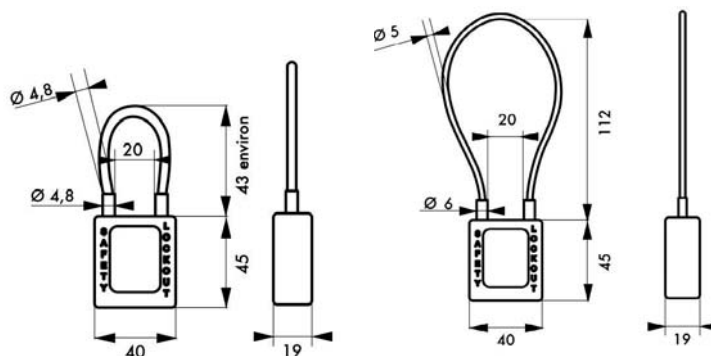

Description/Description/Descripción

Corps ABS non conducteur. Anse acier inoxydable. Mécanisme à goupilles. Double ancrage. Clé « prisonnière » : le cadenas doit être fermé pour reprendre la clé. 1 clé laiton. Livré avec un jeu d'étiquettes.

Non-conductive ABS lock body . Stainless steel shackle. Pin mechanism. Double locking. The padlock must be closed to remove the key. 1 brass key. Supplied with a set of labels.

Cuerpo ABS no conductor. Arco de acero inoxidable. Mecanismo de pasadores. Doble anclaje. Llave "detenida": El candado tiene que estar cerrado para recoger la llave. 1 llave de latón. Entregado con un conjunto de etiquetas.

Finition/Finish/Acabado

Rouge, orange, jaune, vert, Bleu, noir, violet, blanc, marron

Red, orange, yellow, green, blue, black, Purple, white, brown

Rojo, naranja, amarillo, Verde, azul, negro, Púrpura, blanco, marrón

Version/Option/Versión

Anse nylon protection diélectrique, anti-étincelles. Cadenas sur même combinaison. Mise sur passe (PG, PGPP). Clé libre (sur demande). Option : sans retenue de clé et fermeture automatique.

Nylon shackle : Dielectric protection, anti-sparking Arco de nilón protección dieléctrica anti chispas

Utilisation/Use/Utilización

Cadenas résistant aux chocs, à la chaleur, à la corrosion. Idéal pour les applications électriques. La flexibilité du câble permet la condamnation d'appareils sur lesquels une anse standard n'est pas adaptée.

Impact, heat and corrosion resistance. Idéal for electrical applications. The flexibility of the cable allows the devices on which a conviction standard shackle is not suitable.

Impacto, calor y resistencia a la corrosion. Ideal para las aplicaciones eléctricas. La flexibilidad del cable permite la condena de los dispositivos sobre los cuales un arco estándar no está adaptado.



Designation	Boite	Colis.	Prix	Sachet	Colis.	Prix	Brochable					Colis.	Prix
							France	Euro 1	Euro 2	Euro 3	Euro 4		
CADENAS 40 mm câble inox gainé Ø 4,76 X 90 mm - 1 clé ROUGE	005790RD NS	1	-	-	-	-	-	-	-	-	-	-	-
CADENAS 40 mm câble inox gainé Ø 4,76 X 90 mm - 1 clé ORANGE	005790OR NS	1	-	-	-	-	-	-	-	-	-	-	-
CADENAS 40 mm câble inox gainé Ø 4,76 X 90 mm - 1 clé JAUNE	005790YL NS	1	-	-	-	-	-	-	-	-	-	-	-
CADENAS 40 mm câble inox gainé Ø 4,76 X 90 mm - 1 clé VERT	005790GN NS	1	-	-	-	-	-	-	-	-	-	-	-
CADENAS 40 mm câble inox gainé Ø 4,76 X 90 mm - 1 clé BLEU	005790BL NS	1	-	-	-	-	-	-	-	-	-	-	-
CADENAS 40 mm câble inox gainé Ø 4,76 X 90 mm - 1 clé NOIR	005790BK NS	1	-	-	-	-	-	-	-	-	-	-	-
CADENAS 40 mm câble inox gainé Ø 4,76 X 90 mm - 1 clé VIOLET	005790VT NS	1	-	-	-	-	-	-	-	-	-	-	-
CADENAS 40 mm câble inox gainé Ø 4,76 X 90 mm - 1 clé BLANC	005790WT NS	1	-	-	-	-	-	-	-	-	-	-	-
CADENAS 40 mm câble inox gainé Ø 4,76 X 90 mm - 1 clé MARRON	005790BN NS	1	-	-	-	-	-	-	-	-	-	-	-
CADENAS 40 mm câble inox gainé Ø 4,76 X 150 mm - 1 clé ROUGE	005715RD NS	1	-	-	-	-	-	-	-	-	-	-	-
CADENAS 40 mm câble inox gainé Ø 4,76 X 150 mm - 1 clé ORANGE	005715OR NS	1	-	-	-	-	-	-	-	-	-	-	-
CADENAS 40 mm câble inox gainé Ø 4,76 X 150 mm - 1 clé JAUNE	005715YL NS	1	-	-	-	-	-	-	-	-	-	-	-
CADENAS 40 mm câble inox gainé Ø 4,76 X 150 mm - 1 clé VERT	005715GN NS	1	-	-	-	-	-	-	-	-	-	-	-
CADENAS 40 mm câble inox gainé Ø 4,76 X 150 mm - 1 clé BLEU	005715BL NS	1	-	-	-	-	-	-	-	-	-	-	-
CADENAS 40 mm câble inox gainé Ø 4,76 X 150 mm - 1 clé NOIR	005715BK NS	1	-	-	-	-	-	-	-	-	-	-	-
CADENAS 40 mm câble inox gainé Ø 4,76 X 150 - 1 clé VIOLET	005715VT NS	1	-	-	-	-	-	-	-	-	-	-	-
CADENAS 40 mm câble inox gainé Ø 4,76 X 150 mm - 1 clé BLANC	005715WT NS	1	-	-	-	-	-	-	-	-	-	-	-
CADENAS 40 mm câble inox gainé Ø 4,76 X 150 mm - 1 clé BROWN	005715BN NS	1	-	-	-	-	-	-	-	-	-	-	-
CADENAS 40 mm câble inox gainé Ø 6 X 150 mm - 1 clé ROUGE	005615RD NS	1	-	-	-	-	-	-	-	-	-	-	-
CADENAS 40 mm câble inox gainé Ø 6 X 150 mm - 1 clé ORANGE	005615OR NS	1	-	-	-	-	-	-	-	-	-	-	-
CADENAS 40 mm câble inox gainé Ø 6 X 150 mm - 1 clé JAUNE	005615YL NS	1	-	-	-	-	-	-	-	-	-	-	-
CADENAS 40 mm câble inox gainé Ø 6 X 150 mm - 1 clé VERT	005615GN NS	1	-	-	-	-	-	-	-	-	-	-	-
CADENAS 40 mm câble inox gainé Ø 6 X 150 mm - 1 clé BLEU	005615BL NS	1	-	-	-	-	-	-	-	-	-	-	-
CADENAS 40 mm câble inox gainé Ø 6 X 150 mm - 1 clé NOIR	005615BK NS	1	-	-	-	-	-	-	-	-	-	-	-
CADENAS 40 mm câble inox gainé Ø 6 X 150 mm - 1 clé VIOLET	005615VT NS	1	-	-	-	-	-	-	-	-	-	-	-
CADENAS 40 mm câble inox gainé Ø 6 X 150 mm - 1 clé BLANC	005615WT NS	1	-	-	-	-	-	-	-	-	-	-	-
CADENAS 40 mm câble inox gainé Ø 6 X 150 mm - 1 clé MARRON	005615BN NS	1	-	-	-	-	-	-	-	-	-	-	-
CADENAS 40 mm câble inox gainé Ø 6 X 240 mm - 1 clé ROUGE	005624RD NS	1	-	-	-	-	-	-	-	-	-	-	-
CADENAS 40 mm câble inox gainé Ø 6 X 240 mm - 1 clé ORANGE	005624OR NS	1	-	-	-	-	-	-	-	-	-	-	-
CADENAS 40 mm câble inox gainé Ø 6 X 240 mm - 1 clé JAUNE	005624YL NS	1	-	-	-	-	-	-	-	-	-	-	-
CADENAS 40 mm câble inox gainé Ø 6 X 240 mm - 1 clé VERT	005624GN NS	1	-	-	-	-	-	-	-	-	-	-	-
CADENAS 40 mm câble inox gainé Ø 6 X 240 mm - 1 clé BLEU	005624BL NS	1	-	-	-	-	-	-	-	-	-	-	-

NS Non stocké/Non-stored/Productos no estocado - Sur stock Europe Zone 1 et Zone 2, nous consulter pour délai d'approvisionnement - E Epuement/Stock depletion/Agotamiento del stock

Designation	Boite	Colis.	Prix	Sachet	Colis.	Prix	Brochable				Colis.	Prix
							France	Euro 1	Euro 2	Euro 3		
CADENAS 40 mm câble inox gainé Ø 6 X 240 mm - 1 clé NOIR	005624BK NS	1	-	-	-	-	-	-	-	-	-	-
CADENAS 40 mm câble inox gainé Ø 6 X 240 mm - 1 clé VIOLET	005624VT NS	1	-	-	-	-	-	-	-	-	-	-
CADENAS 40 mm câble inox gainé Ø 6 X 240 mm - 1 clé BLANC	005624WT NS	1	-	-	-	-	-	-	-	-	-	-
CADENAS 40 mm câble inox gainé Ø 6 X 240 mm - 1 clé MARRON	005624BN NS	1	-	-	-	-	-	-	-	-	-	-
CADENAS 38 mm câble inox gainé Ø 6 X 1500mm - 1 clé NOIR	0056150BK NS	1	-	-	-	-	-	-	-	-	-	-
CADENAS 38 mm câble inox gainé Ø 6 X 1500mm - 1 clé BLEU	0056150BL NS	1	-	-	-	-	-	-	-	-	-	-
CADENAS 38 mm câble inox gainé Ø 6 X 1500mm - 1 clé MARRON	0056150BN NS	1	-	-	-	-	-	-	-	-	-	-
CADENAS 38 mm câble inox gainé Ø 6 X 1500mm - 1 clé VERT	0056150GN NS	1	-	-	-	-	-	-	-	-	-	-
CADENAS 38 mm câble inox gainé Ø 6 X 1500mm - 1 clé ORANGE	0056150OR NS	1	-	-	-	-	-	-	-	-	-	-
CADENAS 38 mm câble inox gainé Ø 6 X 1500mm - 1 clé ROUGE	0056150RD NS	1	-	-	-	-	-	-	-	-	-	-
CADENAS 38 mm câble inox gainé Ø 6 X 1500mm - 1 clé VIOLET	0056150VT NS	1	-	-	-	-	-	-	-	-	-	-
CADENAS 38 mm câble inox gainé Ø 6 X 1500mm - 1 clé BLANC	0056150WT NS	1	-	-	-	-	-	-	-	-	-	-
CADENAS 38 mm câble inox gainé Ø 6 X 1500mm - 1 clé JAUNE	0056150YL NS	1	-	-	-	-	-	-	-	-	-	-
CADENAS 38 mm câble inox gainé Ø 6 X 1800mm - 1 clé BLEU	0056180BL NS	1	-	-	-	-	-	-	-	-	-	-
CADENAS 38 mm câble inox gainé Ø 6 X 1800mm - 1 clé MARRON	0056180BN NS	1	-	-	-	-	-	-	-	-	-	-
CADENAS 38 mm câble inox gainé Ø 6 X 1800mm - 1 clé VERT	0056180GN NS	1	-	-	-	-	-	-	-	-	-	-
CADENAS 38 mm câble inox gainé Ø 6 X 1800mm - 1 clé ORANGE	0056180OR NS	1	-	-	-	-	-	-	-	-	-	-
CADENAS 38 mm câble inox gainé Ø 6 X 1800mm - 1 clé ROUGE	0056180RD NS	1	-	-	-	-	-	-	-	-	-	-
CADENAS 38 mm câble inox gainé Ø 6 X 1800mm - 1 clé VIOLET	0056180VT NS	1	-	-	-	-	-	-	-	-	-	-
CADENAS 38 mm câble inox gainé Ø 6 X 1800mm - 1 clé BLANC	0056180WT NS	1	-	-	-	-	-	-	-	-	-	-
CADENAS 38 mm câble inox gainé Ø 6 X 1800mm - 1 clé JAUNE	0056180YL NS	1	-	-	-	-	-	-	-	-	-	-
CADENAS 38 mm câble inox gainé Ø 6 X 1800mm - 1 clé NOIR	0056180bk	1	-	-	-	-	-	-	-	-	-	-



005615WT



Cadenas à câble de CONSIGNATION - 40mm RESIST



GARANTIE



X 1

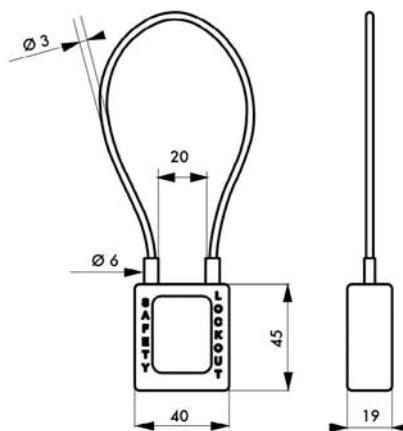

Description/Description/Descripción

Corps ABS non conducteur. Câble acier. Mécanisme à goupilles. 1 clé. Livré avec un jeu d'étiquettes.

Non-conductive ABS lock body. Steel cable. Pin mechanism. 1 key. Supplied with a set of labels.

Cuerpo ABS no conductor. Cable de acero. Mecanismo de pasadores. 1 llave. Entregado con un conjunto de etiquetas.

Finition/Finish/Acabado

Rouge

Red

Rojo

Utilisation/Use/Utilización

Cadenas résistant aux chocs, à la chaleur, à la corrosion. Idéal pour les applications électriques. La flexibilité du câble permet la condamnation d'appareils sur lesquels une anse standard n'est pas adaptée.

Impact, heat and corrosion resistance. Idéal for electrical applications. The flexibility of the cable allows the devices on which a conviction standard shackle is not suitable.

Impacto, calor y resistencia a la corrosión. Ideal para las aplicaciones eléctricas. La flexibilidad del cable permite la condena de los dispositivos sobre los cuales un arco estándar no está adaptado.

Designation	Boîte	Colis.	Prix	Sachet	Colis.	Prix	Brochable					Colis.	Prix
							France	Euro 1	Euro 2	Euro 3	Euro 4		
CADENAS 40 mm câble acier Ø 3 X 150 mm - 1 clé	00091305	1	-	-	-	-	-	-	-	-	-	-	-
CADENAS 40 mm câble acier Ø 3 X 240 mm - 1 clé	00091355 [E] [NS]	1	-	-	-	-	-	-	-	-	-	-	-
CADENAS 40 mm câble acier Ø 3 X 90 - 1 clé	00091356 [E] [NS]	1	-	-	-	-	-	-	-	-	-	-	-

[NS] Non stocké/Non-stored/Producto no estocado - [E] Sur stock Europe Zone 1 et Zone 2, nous consulter pour délai d'approvisionnement - [E] Epuisement/Stock depletion/Agotamiento del stock

CODIFICATIONS CADENAS THIRARD

MATIÈRE DU CORPS							TYPE D'ANSE (MM)
Corps ABS : 5							2: Nylon Ø 6"
Corps laiton : 6							6: Câble Gainé Ø 6"
Corps laiton + bumper : 7							3: Inox Ø 4,76"
							7: Câble Gainé Ø 4,76"
							4: Inox Ø 5"
							8: Nylon Ø 4,76"
							5: Inox Ø 6"
							HAUTEUR D'ANSE CADENAS ABS valeur en mm (25/38/76)
							LONGUEUR CABLE CADENAS ABS valeur en mm (90/150/240)
							HAUTEUR D'ANSE CADENAS LAITON valeur en mm (22/60)
							COULEUR DU CADENAS ABS
							RD: Rouge
							BK: Noir
							OR: Orange
							VT: Violet
							YL: Jaune
							WT: Blanc
							GN: Vert
							BN: Marron
							BL: Bleu
							COULEUR DE LA COQUE POUR CADENAS LAITON
							RD: Rouge
							BK: Noir
							OR: Orange
							BL: Bleu
							YL: Jaune
							GY: Gris
							GN: Vert

Clé prisonnière : 00						
Fermeture Automatique : FA***						

Exemple :

00 00 5 3 38 RD



- * sur cadenas ABS uniquement
- ** sur cadenas LAITON uniquement
- *** non disponible pour câble gainé Ø 6

PERSONNALISATION LASER CADENAS ABS

FICHER À ENVOYER EN FORMAT (.DXF) OU (.PDF).

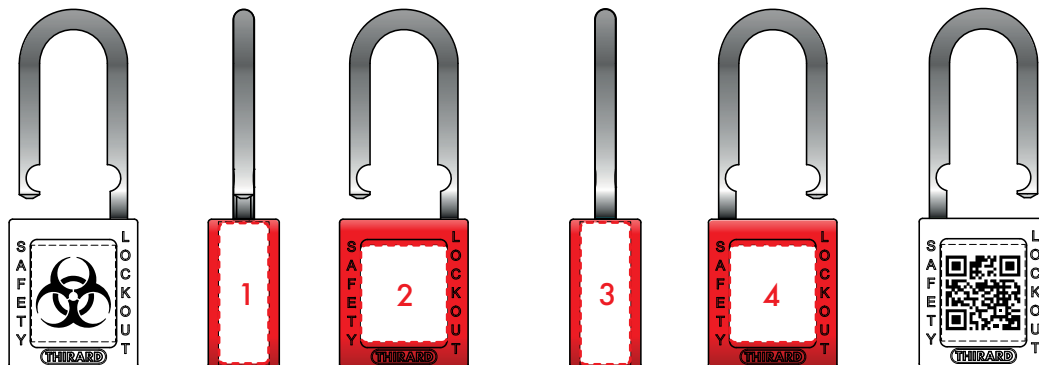

ZONE 0

Gravure du code de la clé et du cadenas (aussi gravé sur la clé).

ZONE 1 & 3

Emplacement pour graver nom ou code
Capacité de marquage:
12 caractères par ligne sur 2 lignes

ZONE 2 & 4 (25mmx32mm)

Emplacement pour graver des logos, repères, noms, codes d'identification, etc...
Capacité de marquage:
8 caractères par ligne sur 5 lignes.



PERSONNALISATION LASER COQUES ABS

FICHER À ENVOYER EN FORMAT (.DXF) OU (.PDF).

ZONE 1

Gravure du code de la clé et du cadenas (aussi gravé sur la clé).

ZONE 3

Emplacement pour graver nom ou code
Capacité de marquage:
14 caractères par ligne sur 2 lignes

ZONE 2 & 4

Emplacement pour graver des logos, repères, noms, codes d'identification, etc...
Capacité de marquage:
8 caractères par ligne sur 5 lignes.

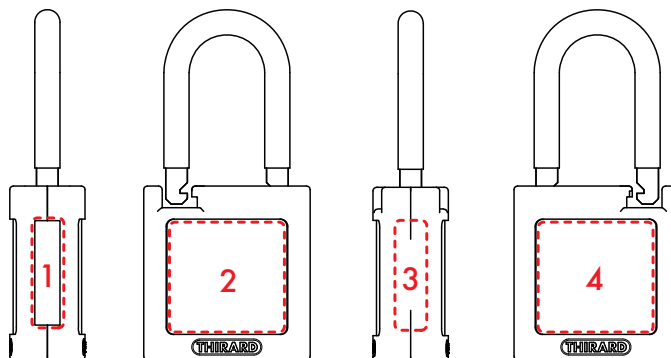



GARANTIE

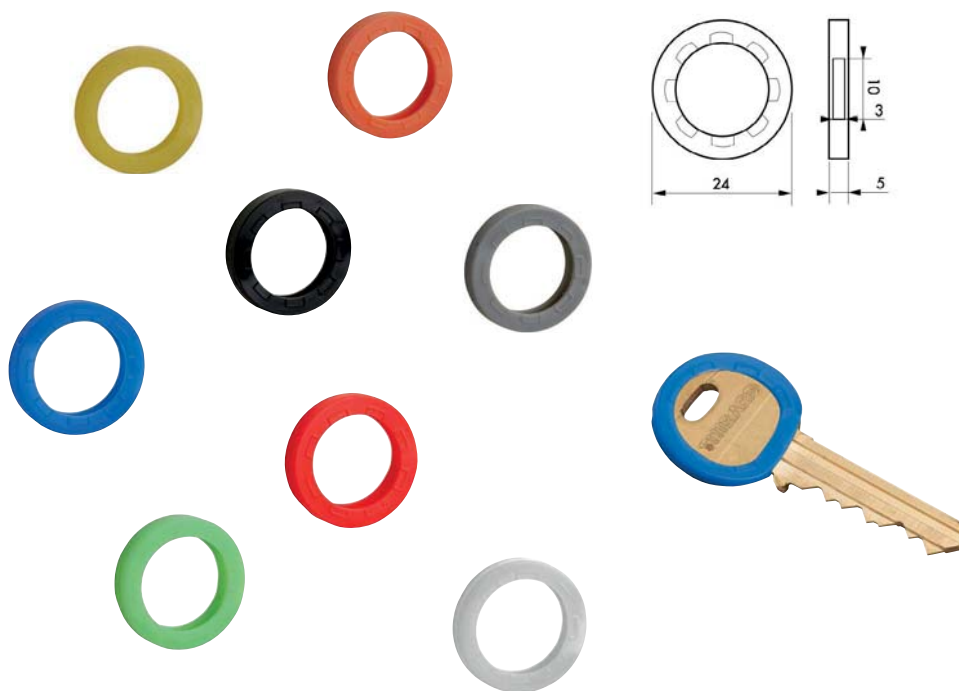

Description/Description/Descripción

Anneau de clé PVC.

PVC key ring.

Anillo PVC.

Finition/Finish/Acabado

Jaune, gris, noir, bleu, rouge, vert, blanc, orange.

Yellow, grey, black, blue, red, green, white, orange.

Amarillo, gris, negro, azul, rojo, verde, blanco, naranja.

Utilisation/Use/Utilización

Identification de clé.

Key identification.

Identificación de la llave.

Designation	Boite	Colis.	Prix	Sachet	Colis.	Prix	Brochable					Colis.	Prix
							France	Euro 1	Euro 2	Euro 3	Euro 4		
ANNEAU DE CLE jaune	00098310	10	-	-	-	-	-	-	-	-	-	-	-
ANNEAU DE CLE gris	00098311	10	-	-	-	-	-	-	-	-	-	-	-
ANNEAU DE CLE noir	00098312	10	-	-	-	-	-	-	-	-	-	-	-
ANNEAU DE CLE bleu	00098313	10	-	-	-	-	-	-	-	-	-	-	-
ANNEAU DE CLE rouge	00098314	10	-	-	-	-	-	-	-	-	-	-	-
ANNEAU DE CLE vert	00098315	10	-	-	-	-	-	-	-	-	-	-	-
ANNEAU DE CLE blanc	00098316	10	-	-	-	-	-	-	-	-	-	-	-
ANNEAU DE CLE orange	00098317	10	-	-	-	-	-	-	-	-	-	-	-

6 ANNEAUX DE CLE GM

ECO



GARANTIE

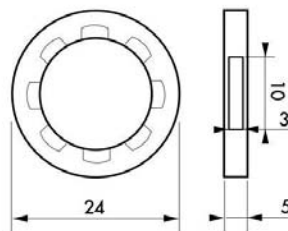

Description/Description/Descripción

Anneau de clé PVC.

PVC key ring.

Anillo PVC.

Finition/Finish/Acabado

Noir, bleu, vert, rouge, jaune, orange

Black, blue, green, red, yellow, orange

Negro, azul, verde, rojo, amarillon naranja

Utilisation/Use/Utilización

Identification de clé.

Key identification.

Identificación de la llave.

Designation	Boite	Colis.	Prix	Sachet	Colis.	Prix	Brochable					Colis.	Prix
							France	Euro 1	Euro 2	Euro 3	Euro 4		
ANNEAU DE CLE jaune	-	-	-	-	-	-	00198320	-	-	00194328	-	10	-

☒ Non stocké/Non-stored/Producto no estocado - ☑ Sur stock Europe Zone 1 et Zone 2, nous consulter pour délai d'approvisionnement - ☒ Epuisement/Stock depletion/Agotamiento del stock

Accessoires de cadenas de consignation / BUMPER pour cadenas de consignation

ECO



GARANTIE



Description/Description/Descripción

Caoutchouc

Rubber

Caucho

Finition/Finish/Acabado

Noir

Black

Negro

Utilisation/Use/Utilización

Pour cadenas de consignation : 005238 - 005338 - 005538 - 005376 - 005576 - 005790 - 005715 - 005615 - 005624

Available to consignment padlocks : 005238 - 005338 - 005538 - 005376 - 005576 - 005790 - 005715 - 005615 - 005624

Para candados de consignación : 005238 - 005338 - 005538 - 005376 - 005576 - 005790 - 005715 - 005615 - 005624

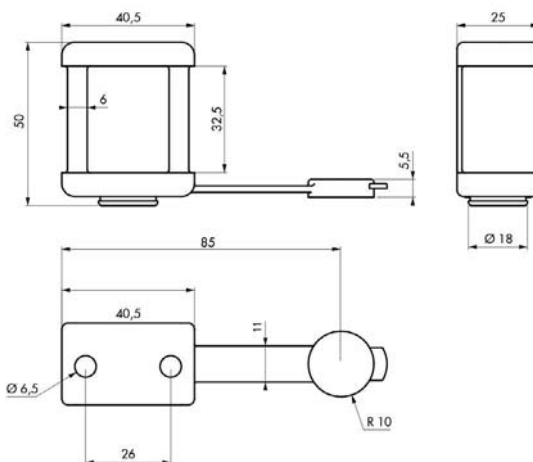

Designation	Boite	Colis.	Prix	Sachet	Colis.	Prix	Brochable					Colis.	Prix
							France	Euro 1	Euro 2	Euro 3	Euro 4		
BUMPER pour cadenas de CONSIGNATION	00009691	1	-	-	-	-	-	-	-	-	-	-	-

⚠ Non stocké/Non-stored/Producto no estocado - 📦 Sur stock Europe Zone 1 et Zone 2, nous consulter pour délai d'approvisionnement - 📦 Epuisement/Stock depletion/Agotamiento del stock

Accessoire de cadenas de CONSIGNATION RESIST



GARANTIE



exemple d'utilisation

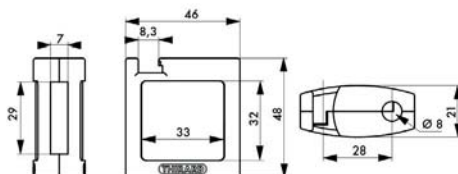

Description/Description/Descripción

Corps ABS.

ABS shell.

Cuerpo ABS.

Finition/Finish/Acabado

Gris, rouge, orange, jaune, vert, bleu, noir

Grey, red, orange, yellow, green, blue, black.

Gris, rojo, naranja, amarillo, verde, azul, negro.

Utilisation/Use/Utilización

Pour cadenas MACH3 standard et de consignation sans bumper

For standard and lock-out MACH3 padlock without bumper

Para el candado MACH3 estándar y de consignación sin bumper

Designation	Boite	Colis.	Prix	Sachet	Colis.	Prix	Brochable					Colis.	Prix
							France	Euro 1	Euro 2	Euro 3	Euro 4		
Ensemble coque ABS AV + AR grise pour cadenas M3 - 40 mm	00084713	1	-	-	-	-	-	-	-	-	-	-	-
Ensemble coque ABS AV + AR rouge pour cadenas M3 - 40 mm	00084714	1	-	-	-	-	-	-	-	-	-	-	-
Ensemble coque ABS AV + AR orange pour cadenas M3 - 40 mm	00084715	1	-	-	-	-	-	-	-	-	-	-	-
Ensemble coque ABS AV + AR jaune pour cadenas M3 - 40 mm	00084716	1	-	-	-	-	-	-	-	-	-	-	-
Ensemble coque ABS AV + AR verte pour cadenas M3 - 40 mm	00084717	1	-	-	-	-	-	-	-	-	-	-	-
Ensemble coque ABS AV + AR bleue pour cadenas M3 - 40 mm	00084718	1	-	-	-	-	-	-	-	-	-	-	-
Ensemble coque ABS AV + AR noire pour cadenas M3 - 40 mm	00084719	1	-	-	-	-	-	-	-	-	-	-	-

Non stocké/Non-stored/Producto no estocado - Sur stock Europe Zone 1 et Zone 2, nous consulter pour délai d'approvisionnement - Epuement/Stock depletion/Agotamiento del stock

Mâchoire de CONSIGNATION RESIST



GARANTIE



00091192

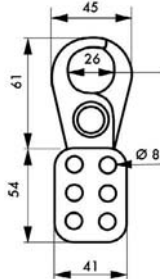

00091191

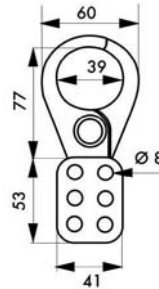

00091304

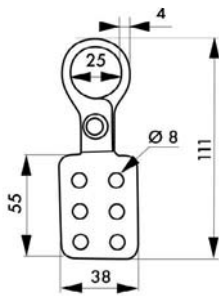
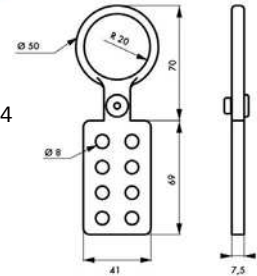

00091231

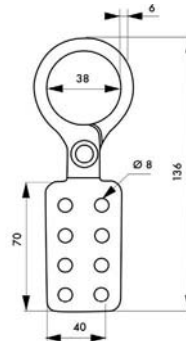

00091232



Description/Description/Descripción

Acier inoxydable isolé par coque ABS. Condamnation par 6 cadenas. La mâchoire ne peut pas être ouverte avant que tous les cadenas ne soient retirés.
Stainless steel, insulation resin. Can be locked by 6 padlocks. Control cannot be turned on until last worker's padlock is removed.

Acero inoxidable aislado por caja ABS. Condenación por 6 candados. El control no se puede poner en marcha hasta que se haya quitado la pinza.

Finition/Finish/Acabado

Rouge / Red / Rojo

Utilisation/Use/Utilización

Possibilité pour plusieurs personnes de condamner / travailler simultanément. Idéal pour les applications électriques.

Lockout by multiple workers at each lockout point. Idéal for electrical applications.

Possibilidad para varias personas de condenar/trabajar simultáneamente. Ideal para las aplicaciones eléctricas.

Designation	Boite	Colis.	Prix	Sachet	Colis.	Prix	Brochable					Colis.	Prix
							France	Euro 1	Euro 2	Euro 3	Euro 4		
MÂCHOIRE acier inoxydable isolé Ø intérieur 39 mm pour 6 cadenas	00091191	1	-	-	-	-	-	-	-	-	-	-	-
MÂCHOIRE acier inoxydable isolé Ø intérieur 26 mm pour 6 cadenas	00091192	1	-	-	-	-	-	-	-	-	-	-	-
MÂCHOIRE aluminium isolée Ø 4 mm 6 trous - Ø intérieur 25 mm	00091231	1	-	-	-	-	-	-	-	-	-	-	-
MÂCHOIRE aluminium isolée Ø 6 mm 8 trous - Ø intérieur 38 mm	00091232	1	-	-	-	-	-	-	-	-	-	-	-
MÂCHOIRE aluminium isolé Ø intérieur 39 mm pour 8 cadenas	00091304	1	-	-	-	-	-	-	-	-	-	-	-

⚠ Non stocké/Non-stored/Producto no estocado - 📦 Sur stock Europe Zone 1 et Zone 2, nous consulter pour délai d'approvisionnement - 📦 Epuisement/Stock depletion/Agotamiento del stock

Mâchoire de CONSIGNATION RESIST



GARANTIE

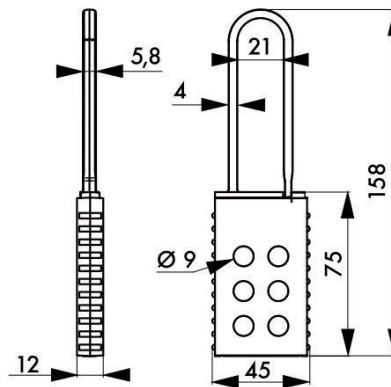

Description/Description/Descripción

Condamnación por cadenas. La mâchoire ne peut pas être ouverte avant que tous les cadenas ne soient retirés. Can be locked by padlocks. Control cannot be turned on until last worker's padlock is removed.

Condenación por candados. El control no se puede poner en marcha hasta que se haya quitado la pinza.

Finition/Finish/Acabado

Rouge, gris

Red, grey

Rojo, gris

Version/Option/Versión

Aluminium (ref : 091302). Aluminium (ref : 0 91194) avec étiquette informative. Corps et anse nylon (ref : 091193) non conducteur, protection diélectrique, anti-étincelles.

Aluminium (ref :091302). Aluminium (ref. 091194) with identification label. Non-conductive body (ref : 091193) diélectric protection, anti-sparking

Aluminio (ref. 091302). Aluminio (ref. 091194) con etiqueta informativa. Cuerpo y arco de nylon (ref. 091193) no conductor, protección dieléctrica, anti chispas.

Utilisation/Use/Utilización

Possibilité pour plusieurs personnes de condamner / travailler simultanément. Idéal pour les applications électriques.

Lockout by multiple workers at each lockout point. Idéal for electrical applications.

Posibilidad para viarias personas de condenar/trabajar simultáneamente. Ideal para las aplicaciones eléctricas.

Designation	Boîte	Colis.	Prix	Sachet	Colis.	Prix	Brochable					Colis.	Prix
							France	Euro 1	Euro 2	Euro 3	Euro 4		
MORAILLON en nylon pour 6 cadenas	00091193	1	-	-	-	-	-	-	-	-	-	-	-

Non stocké/Non-stored/Producto no estocado - Sur stock Europe Zone 1 et Zone 2, nous consulter pour délai d'approvisionnement - Epuement/Stock depletion/Agotamiento del stock

Mâchoire de CONSIGNATION RESIST



GARANTIE



00091233



00091234

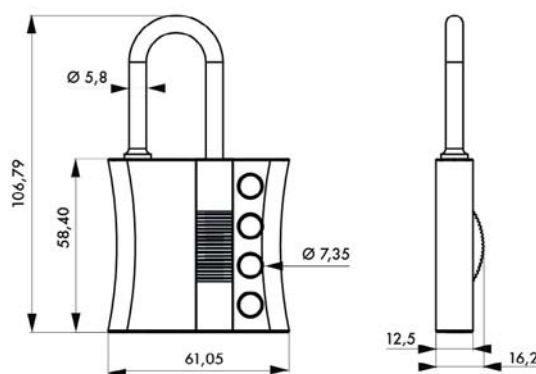
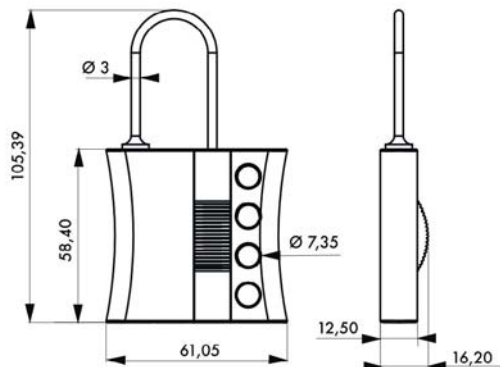

Description/Description/Descripción

Nylon isolé par coque ABS. Condamnation par cadenas. La mâchoire ne peut pas être ouverte avant que tous les cadenas ne soient retirés.

Nylon, insulation resin. Can be locked by padlocks. Control cannot be turned on until last worker's padlock is removed.

Nilón aislado por caja ABS. Condenación por candados. El control no se puede poner en marcha hasta que se haya quitado la pinza.

Finition/Finish/Acabado

Jaune.

Yellow.

Amarillo.

Utilisation/Use/Utilización

Possibilité pour plusieurs personnes de condamner / travailler simultanément. Idéal pour les applications électriques.

Lockout by multiple workers at each lockout point. Idéal for electrical applications.

Posibilidad para varias personas de condenar/trabajar simultáneamente. Ideal para las aplicaciones eléctricas.

Designation	Boite	Colis.	Prix	Sachet	Colis.	Prix	Brochable					Colis.	Prix
							France	Euro 1	Euro 2	Euro 3	Euro 4		
MÂCHOIRE nylon PP Ø 3mm isolée 4 trous	00091233	1	-	-	-	-	-	-	-	-	-	-	-
MÂCHOIRE nylon PP Ø 6mm isolée 4 trous	00091234	1	-	-	-	-	-	-	-	-	-	-	-

⚠ Non stocké/Non-stored/Producto no estocado - 📦 Sur stock Europe Zone 1 et Zone 2, nous consulter pour délai d'approvisionnement - 📦 Epuisement/Stock depletion/Agotamiento del stock

Mâchoire de CONSIGNATION RESIST

00091194

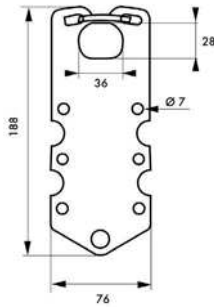

00091302



GARANTIE



Description/Description/Descripción

Condamnation par cadenas. La mâchoire ne peut pas être ouverte avant que tous les cadenas ne soient retirés. Can be locked by padlocks. Control cannot be turned on until last worker's padlock is removed.

Condenación por candados. El control no se puede poner en marcha hasta que se haya quitado la pinza.

Finition/Finish/Acabado

Rouge, gris

Red, grey

Rojo, gris

Versión/Option/Versión

Aluminium (ref : 091302). Aluminium (ref : 0 91194) avec étiquette informative. Corps et anse nylon (ref : 091193) non conducteur, protection diélectrique, anti-étincelles.

Aluminium (ref :091302). Aluminium (ref. 091194) with identification label. Non-conductive body (ref : 091193) diélectric protection, anti-sparking Aluminium (ref. 091302). Aluminio (ref. 091194) con etiqueta informativa. Cuerpo y arco de nilón (ref. 091193) no conductor, protección diélectrica, anti chispas.

Utilisation/Use/Utilización

Possibilité pour plusieurs personnes de condamner / travailler simultanément. Idéal pour les applications électriques.

Lockout by multiple workers at each lockout point. Idéal for electrical applications.

Simultaneidade para viarias personas de condenar/trabajar simultaneamente. Ideal para las aplicaciones eléctricas.

Designation	Boîte	Colis.	Prix	Sachet	Colis.	Prix	Brochable					Colis.	Prix
							France	Euro 1	Euro 2	Euro 3	Euro 4		
MÂCHOIRE en aluminium Ø 36 x 28 pour 6 cadenas	00091194	1	-	-	-	-	-	-	-	-	-	-	-
MORAILLON en aluminium pour 4 cadenas	00091302	1	-	-	-	-	-	-	-	-	-	-	-

BOITE DE COLLECTE DE CLES RESIST



exemple d'utilisation

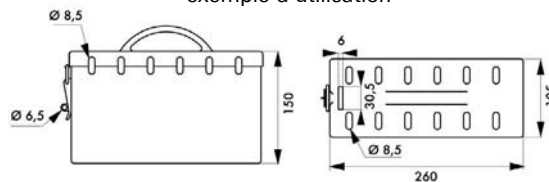

GARANTIE

Description/Description/Descripción

Acier. Condamnation par cadenas.

Steel. Can be locked by padlocks

Acero. Condenación

Finition/Finish/Acabado

Rouge / Red / Rojo

Utilisation/Use/Utilización

Collecte de clés lors des opérations de consignation.

Collection of keys during consignment operations.

Asegure sus llaves en el cuadro de bloqueo.

Designation	Boîte	Colis.	Prix	Sachet	Colis.	Prix	Brochable					Colis.	Prix
							France	Euro 1	Euro 2	Euro 3	Euro 4		
BOÎTE de collecte de clés	00091287	1	-	-	-	-	-	-	-	-	-	-	-

Consignation de DISJONCTEUR RESIST

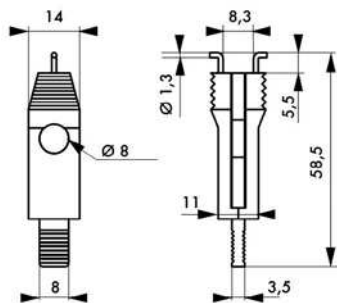

GARANTIE



Description/Description/Descripción

Nylon armé. S'adapte aux disjoncteurs munis d'interrupteur à bascule. Verrouillage par cadenas. Pour mini disjoncteur 11mm

Super nylon body. For miniature circuit breaker. Locking by padlock. For mini circuit breaker 11mm.

Nilón armado. Se adapta a los disyuntores dotados de interruptor con báscula. Bloqueo por candado. Para mini disyuntor 11mm

Finition/Finish/Acabado

Rouge / Red / Rojo

Utilisation/Use/Utilización

Consignation de disjoncteurs

Electrical lockout device

Consignación de disyuntores

Designation	Boite	Colis.	Prix	Sachet	Colis.	Prix	Brochable					Colis.	Prix
							France	Euro 1	Euro 2	Euro 3	Euro 4		
VERROUILLAGE mini disjoncteur 11 mm	00091180	1	-	-	-	-	-	-	-	-	-	-	-

Consignation de DISJONCTEUR RESIST

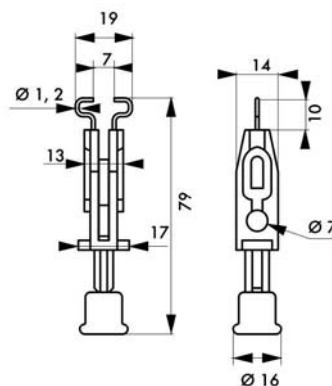

GARANTIE



Description/Description/Descripción

Nylon armé. S'adapte aux disjoncteurs munis d'interrupteur à bascule. Verrouillage par cadenas. nylon body. For miniature circuit breaker. Locking by padlock.

armado. Se adapta a los disyuntores dotados de interruptor con báscula. Bloqueo por candado.

Finition/Finish/Acabado

Rouge / Red / Rojo

Versión/Option/Versión

mini disjoncteur 11mm (091180). Pour mini disjoncteur 20 mm (091181). Pour mini disjoncteur 12,7 mm maxi (091313).

mini circuit breaker 11mm (091180). For mini circuit breaker 20mm (091181). For mini circuit breaker 12,7mm maxi (091313).

mini disyuntor 11mm (091180). Para mini disyuntor 20mm (091181). Para mini disyuntor 12,7mm maxi (091313).

Utilisation/Use/Utilización

Consignation de disjoncteurs

Electrical lockout device

Consignación de disyuntores

Designation	Boite	Colis.	Prix	Sachet	Colis.	Prix	Brochable					Colis.	Prix
							France	Euro 1	Euro 2	Euro 3	Euro 4		
VERROUILLAGE mini disjoncteur 12,7 mm maxi	00091313	1	-	-	-	-	-	-	-	-	-	-	-

⚠ Non stocké/Non-stored/Producto no estocado - 📦 Sur stock Europe Zone 1 et Zone 2, nous consulter pour délai d'approvisionnement - 📦 Epuisement/Stock depletion/Agotamiento del stock

Consignation de DISJONCTEUR RESIST



GARANTIE



Références :
091312



00091228



00091312

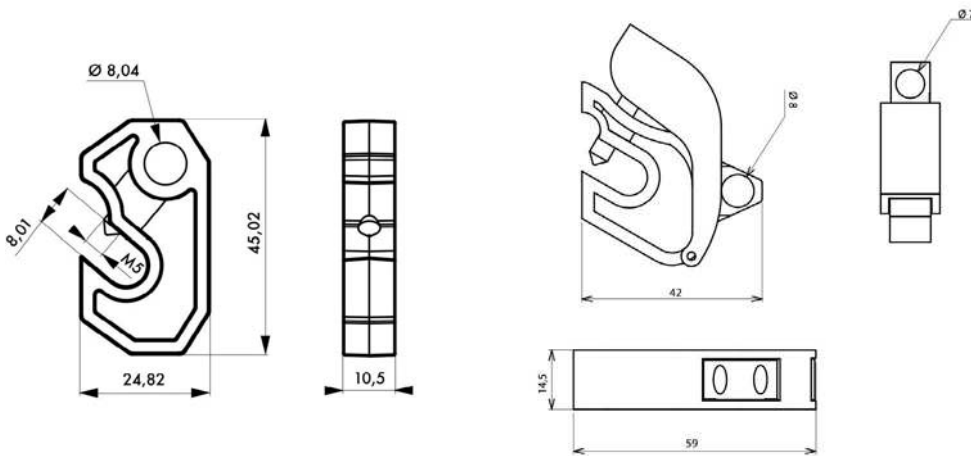

Description/Description/Descripción

Nylon armé. S'adapte aux disjoncteurs munis d'interrupteur à bascule. Verrouillage par cadenas.

Super nylon body. For miniature circuit breaker. Locking by padlock.

Nilón armado. Se adapta a los disyuntors dotados de interruptor con báscula. Bloqueo por candado.

Finition/Finish/Acabado

Rouge.

Red.

Rojo.

Utilisation/Use/Utilización

Consignation de disjoncteurs

Electrical lockout device

Consignación de disyuntors



Designation	Boite	Colis.	Prix	Sachet	Colis.	Prix	Brochable					Colis.	Prix
							France	Euro 1	Euro 2	Euro 3	Euro 4		
Petit VERROUILLAGE de disjoncteur universel à visser	00091228	1	-	-	-	-	-	-	-	-	-	-	-
VERROUILLAGE disjoncteur universel	00091312	1	-	-	-	-	-	-	-	-	-	-	-

Non stocké/Non-stored/Producto no estocado - Sur stock Europe Zone 1 et Zone 2, nous consulter pour délai d'approvisionnement - Epuement/Stock depletion/Agotamiento del stock

Consignation de DISJONCTEUR RESIST



GARANTIE

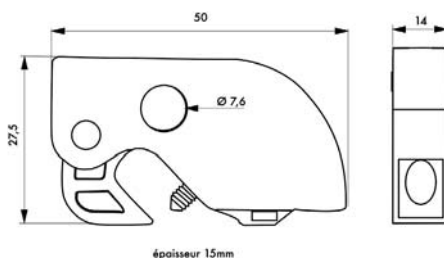

Description/Description/Descripción

Nylon armé. S'adapte aux disjoncteurs munis d'interrupteur à bascule. Verrouillage par cadenas.
Super nylon body. For miniature circuit breaker. Locking by padlock.

Nilón armado. Se adapta a los disyuntore dotados de interruptor con báscula. Bloqueo por candado.

Finition/Finish/Acabado

Rouge / Red / Rojo

Utilisation/Use/Utilización

Consignation de disjoncteurs

Electrical lockout device

Consignación de disyuntore

Designation	Boite	Colis.	Prix	Sachet	Colis.	Prix	Brochable					Colis.	Prix
							France	Euro 1	Euro 2	Euro 3	Euro 4		
Petit VERROUILLAGE de disjoncteur universel 2 positions	00091255	1	-	-	-	-	-	-	-	-	-	-	-

Consignation de DISJONCTEUR RESIST



GARANTIE

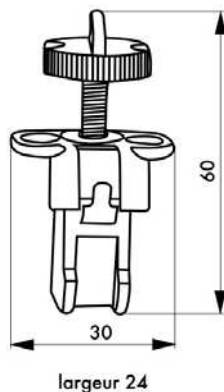

Description/Description/Descripción

Nylon armé. S'adapte aux disjoncteurs munis d'interrupteur à bascule. Verrouillage par cadenas.
Super nylon body. For miniature circuit breaker. Locking by padlock.

Nilón armado. Se adapta a los disyuntore dotados de interruptor con báscula. Bloqueo por candado.

Finition/Finish/Acabado

Rouge.

Red.

Rojo.

Utilisation/Use/Utilización

Consignation de disjoncteurs à bascule

Electrical lockout device for miniature circuit breaker.

Consignación de disyuntore otados de interruptor con báscula.

Designation	Boite	Colis.	Prix	Sachet	Colis.	Prix	Brochable					Colis.	Prix
							France	Euro 1	Euro 2	Euro 3	Euro 4		
VERROUILLAGE mini disjoncteur double	00091254	1	-	-	-	-	-	-	-	-	-	-	-

⚠ Non stocké/Non-stored/Producto no estocado - 📦 Sur stock Europe Zone 1 et Zone 2, nous consulter pour délai d'approvisionnement - 📦 Epuisement/Stock depletion/Agotamiento del stock

Consignation de DISJONCTEUR RESIST

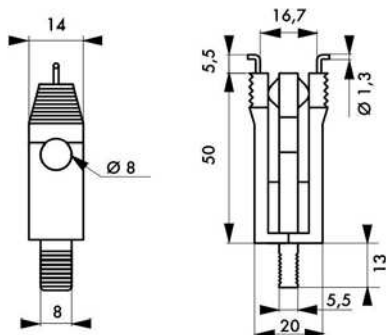

GARANTIE



Description/Description/Descripción

Nylon armé. S'adapte aux disjoncteurs munis d'interrupteur à bascule. Verrouillage par cadenas.
Super nylon body. For miniature circuit breaker. Locking by padlock.
Nilón armado. Se adapta a los disyuntors dotados de interruptor con báscula. Bloqueo por candado.

Finition/Finish/Acabado

Rouge / Red / Rojo
Utilisation/Use/Utilización
Consignation de disjoncteurs
Electrical lockout device
Consignación de disyuntors

Designation	Boite	Colis.	Prix	Sachet	Colis.	Prix	Brochable					Colis.	Prix
							France	Euro 1	Euro 2	Euro 3	Euro 4		
VERROUILLAGE mini disjoncteur 20 mm	00091181	1	-	-	-	-	-	-	-	-	-	-	-

Consignation de DISJONCTEUR RESIST

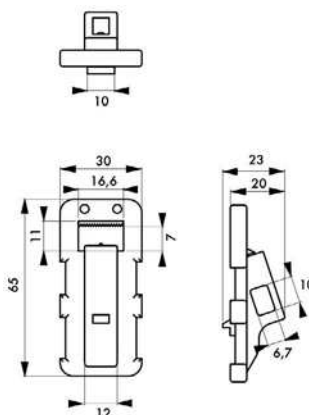

GARANTIE

Description/Description/Descripción

Nylon armé. S'adapte aux disjoncteurs munis d'interrupteur. Ajustable. Verrouillage par cadenas.
Super nylon body. For miniature circuit breaker with switch. Adjustable. Locking by padlock.
Nilón armado. Se adapta a los disyuntors dotados de conmutador. Ajustable. Bloqueo por candado.

For switch 220/380 V, lever 16.6 mm maximum width and 7 mm (091182). For switch 380/600 V, lever 41 mm maximum width and 15,8 mm (091183).
Para conmutador 220/380 V, palanca de 16,6 mm de anchura máxima y 7 mm (091182). Para conmutador 380/600 V, palanca de 41 mm de anchura máxima y 15,8 mm (091183).

Finition/Finish/Acabado

Rouge / Red / Rojo

Versión/Option/Versión

Pour interrupteur 220 / 380 V, levier 16,6 mm de largeur maxi et 7 mm d'épaisseur (091182). Pour interrupteur 380 / 600 V, levier 41 mm de largeur maxi et 15,8 mm d'épaisseur (091183).

Utilisation/Use/Utilización

Consignation de disjoncteurs
Electrical lockout device
Consignación de disyuntors

Designation	Boite	Colis.	Prix	Sachet	Colis.	Prix	Brochable					Colis.	Prix
							France	Euro 1	Euro 2	Euro 3	Euro 4		
VERROUILLAGE disjoncteur	00091182	1	-	-	-	-	-	-	-	-	-	-	-

Consignation de DISJONCTEUR RESIST

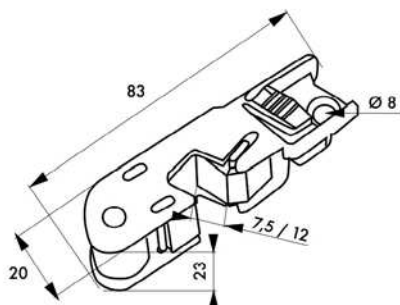

GARANTIE

Description/Description/Descripción

Nylon armé. S'adapte aux disjoncteurs munis d'interrupteur à bascule. Verrouillage par cadenas. Fixation Grip.

Super nylon body. For miniature circuit breaker. Locking by padlock. Grip fixing.

Nilón armado. Se adapta a los disyuntore dotados de interruptor con báscula. Bloqueo por candado. Fijación Grip.

Finition/Finish/Acabado

Rouge / Red / Rojo

Utilisation/Use/Utilización

Consignation de disjoncteurs

Electrical lockout device

Consignación de disyuntore

Designation	Boite	Colis.	Prix	Sachet	Colis.	Prix	Brochable					Colis.	Prix
							France	Euro 1	Euro 2	Euro 3	Euro 4		
VERROUILLAGE disjoncteur à levier moyen	00091256	1	-	-	-	-	-	-	-	-	-	-	-

Consignation de DISJONCTEUR RESIST

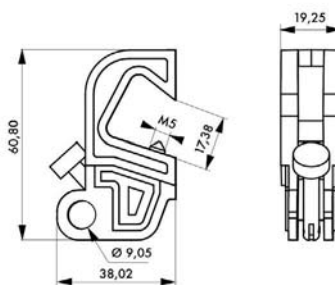

GARANTIE

Description/Description/Descripción

Nylon armé. S'adapte aux disjoncteurs munis d'interrupteur à bascule. Verrouillage par cadenas.

Super nylon body. For miniature circuit breaker. Locking by padlock.

Nilón armado. Se adapta a los disyuntore dotados de interruptor con báscula. Bloqueo por candado.

Finition/Finish/Acabado

Rouge / Red / Rojo

Utilisation/Use/Utilización

Consignation de disjoncteurs

Electrical lockout device

Consignación de disyuntore

Designation	Boite	Colis.	Prix	Sachet	Colis.	Prix	Brochable					Colis.	Prix
							France	Euro 1	Euro 2	Euro 3	Euro 4		
VERROUILLAGE mini disjoncteur universel à molette pour levier de 10 à 17mm	00091229	1	-	-	-	-	-	-	-	-	-	-	-

⚠ Non stocké/Non-stored/Producto no estocado - 📦 Sur stock Europe Zone 1 et Zone 2, nous consulter pour délai d'approvisionnement - 📦 Epuisement/Stock depletion/Agotamiento del stock

Consignation de DISJONCTEUR RESIST



GARANTIE

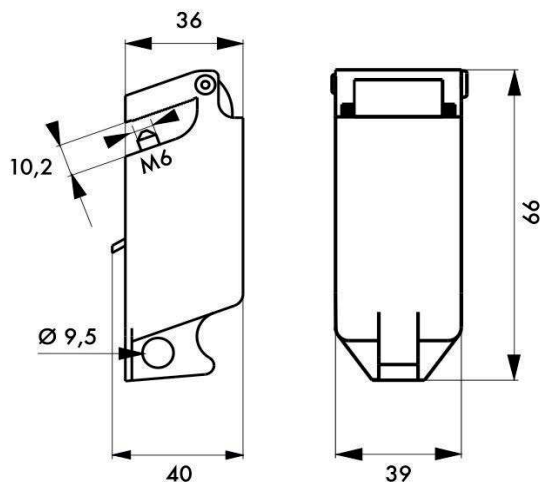

Description/Description/Descripción

Nylon armé. S'adapte aux disjoncteurs munis d'interrupteur à bascule. Verrouillage par cadenas.
Super nylon body. For miniature circuit breaker. Locking by padlock.

Nilón armado. Se adapta a los disyuntores dotados de interruptor con báscula. Bloqueo por candado.

Finition/Finish/Acabado

Rouge

Red

Rojo

Utilisation/Use/Utilización

Consignation de disjoncteurs

Electrical lockout device

Consignación de disyuntores

Designation	Boite	Colis.	Prix	Sachet	Colis.	Prix	Brochable					Colis.	Prix
							France	Euro 1	Euro 2	Euro 3	Euro 4		
VERROUILLAGE ajustable pour disjoncteur à levier	00091281	1	-	-	-	-	-	-	-	-	-	-	-

Consignation de DISJONCTEUR RESIST

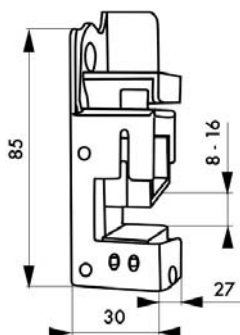

GARANTIE

Description/Description/Descripción

Nylon armé. S'adapte aux disjoncteurs munis d'interrupteur à bascule. Verrouillage par cadenas. Fixation Grip.

Super nylon body. For miniature circuit breaker. Locking by padlock. Grip fixing.

Nilón armado. Se adapta a los disyuntors dotados de interruptor con báscula. Bloqueo por candado. Fijación Grip.

Finition/Finish/Acabado

Rouge / Red / Rojo

Utilisation/Use/Utilización

Consignation de disjoncteurs

Electrical lockout device

Consignación de disyuntors

Designation	Boite	Colis.	Prix	Sachet	Colis.	Prix	Brochable					Colis.	Prix
							France	Euro 1	Euro 2	Euro 3	Euro 4		
VERROUILLAGE disjoncteur à levier large	00091257	1	-	-	-	-	-	-	-	-	-	-	-

Consignation de DISJONCTEUR RESIST

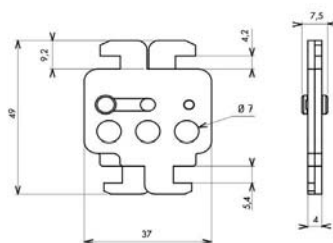

GARANTIE

Description/Description/Descripción

Corps acier traité contre la corrosion. S'adapte aux disjoncteurs munis d'interrupteur à bascule. Verrouillage par cadenas.

Steel body with rust-proof treatment. For miniature circuit breaker. Locking by padlock.

Cuerpo de acero con tratamiento contra la corrosión. Se adapta a los disyuntors dotados de interruptor con báscula. Bloqueo por candado.

Finition/Finish/Acabado

Noir / Black / Negro

Utilisation/Use/Utilización

Consignation de disjoncteurs

Electrical lockout device

Consignación de disyuntors

Designation	Boite	Colis.	Prix	Sachet	Colis.	Prix	Brochable					Colis.	Prix
							France	Euro 1	Euro 2	Euro 3	Euro 4		
Double VERROUILLAGE disjoncteur boitiers moulés 3 trous	00091230	1	-	-	-	-	-	-	-	-	-	-	

⚠ Non stocké/Non-stored/Producto no estocado - ☑ Sur stock Europe Zone 1 et Zone 2, nous consulter pour délai d'approvisionnement - ☑ Epuisement/Stock depletion/Agotamiento del stock

Consignation de DISJONCTEUR RESIST

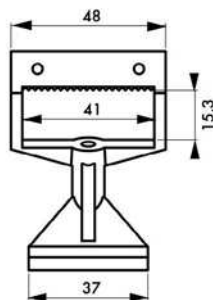
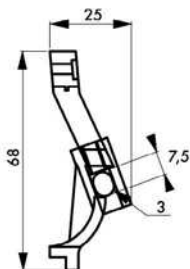

GARANTIE



Description/Description/Descripción

Nylon armé. S'adapte aux disjoncteurs munis d'interrupteur. Ajustable. Verrouillage par cadenas. Pour interrupteur 380 / 600 V, levier 41 mm de largeur maxi et 15,8 mm d'épaisseur.

Super nylon body. For miniature circuit breaker with switch. Adjustable. Locking by padlock. For switch 380/600 V, lever 41 mm maximum width and 15,8 mm. Nilón armado. Se adapta a los disyuntors dotados de conmutador. Ajustable. Bloqueo por candado. Para conmutador 380/600 V, palanca de 41 mm de anchura máxima y 15,8 mm.

Finition/Finish/Acabado

Rouge / Red / Rojo

Version/

Utilisation/Use/Utilización

Consignation de disjoncteurs

Electrical lockout device

Consignación de disyuntors

Designation	Boite	Colis.	Prix	Sachet	Colis.	Prix	Brochable					Colis.	Prix
							France	Euro 1	Euro 2	Euro 3	Euro 4		
VERROUILLAGE disjoncteur	00091183	1	-	-	-	-	-	-	-	-	-	-	-

Consignation de DISJONCTEUR RESIST

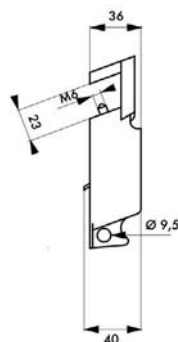
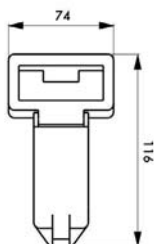

GARANTIE

Description/Description/Descripción

S'adapte aux disjoncteurs munis d'interrupteur à bascule. Verrouillage par cadenas.

For circuit breaker. Locking by padlock. Se adapta a los disyuntors dotados de interruptor con báscula. Bloqueo por candado.

Finition/Finish/Acabado

Rouge / Red / Rojo

Version/Option/Versión

Ajustable pour disjoncteur à levier largeur maxi 55 mm, hauteur maxi 22 mm.

For circuit breaker. Adjustable for maximum width 55 mm, maximum height 22 mm.

Ajustable para disyuntor a palanca de anchura máxima de 55 mm, la altura máxima de 22 mm.

Utilisation/Use/

Consignation de disjoncteurs 380 / 600V

Electrical lockout device 380 / 600V

Designation	Boite	Colis.	Prix	Sachet	Colis.	Prix	Brochable					Colis.	Prix
							France	Euro 1	Euro 2	Euro 3	Euro 4		
VERROUILLAGE ajustable pour disjoncteur à bascule	00091326	1	-	-	-	-	-	-	-	-	-	-	-

Consignation de SECTIONNEUR RESIST



GARANTIE

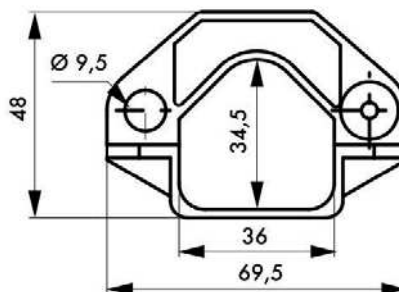
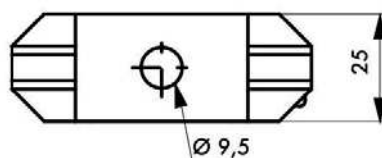

Description/Description/Descripción

Nylon armé. S'adapte aux leviers de sectionneur.
Ensemble de 2 dispositifs pour levier de sectionneur (rouge + vert pour visualiser les positions ON et OFF) Ø 30 mm maxi. Verrouillage par cadenas.
Super nylon body. For electrical cabinet switch. Ø 30 mm max. Locking by padlock.
Nilón armado. Se adapta a la palanca del interruptor. Ø 30 mm max. Bloqueo por candado.

Finition/Finish/Acabado

Rouge - vert

Red - green

Rojo - verde

Utilisation/Use/Utilización

Consignation de disjoncteurs

Electrical lockout device

Consignación de disyuntores

Designation	Boite	Colis.	Prix	Sachet	Colis.	Prix	Brochable					Colis.	Prix
							France	Euro 1	Euro 2	Euro 3	Euro 4		
CONSIGNATION de sectionneur (2 pièces)	00091327	1	-	-	-	-	-	-	-	-	-	-	-

⚠ Non stocké/Non-stored/Producto no estocado - 📦 Sur stock Europe Zone 1 et Zone 2, nous consulter pour délai d'approvisionnement - 📦 Epuisement/Stock depletion/Agotamiento del stock

Consignation de DISJONCTEUR MAGNÉTO-THERMIQUE RESIST



GARANTIE



00091259



00091258

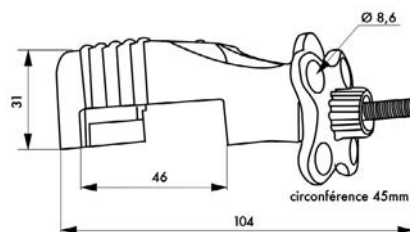
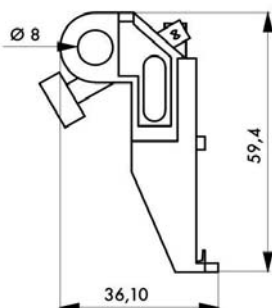
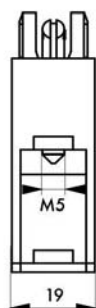

Description/Description/Descripción

Nylon armé. S'adapte aux disjoncteurs munis d'interrupteur à bascule. Verrouillage par cadenas.
Super nylon body. For miniature circuit breaker. Locking by padlock.

Nilón armado. Se adapta a los disyuntors dotados de interruptor con báscula. Bloqueo por candado.

Finition/Finish/Acabado

Rouge.

Red.

Rojo.

Utilisation/Use/Utilización

Consignation de disjoncteurs

Electrical lockout device

Consignación de disyuntors



Designation	Boite	Colis.	Prix	Sachet	Colis.	Prix	Brochable					Colis.	Prix
							France	Euro 1	Euro 2	Euro 3	Euro 4		
VERROUILLAGE disjoncteur magnéto-thermique GM	00091258	1	-	-	-	-	-	-	-	-	-	-	-
VERROUILLAGE disjoncteur magnéto-thermique PM	00091259	1	-	-	-	-	-	-	-	-	-	-	-

Non stocké/Non-stored/Producto no estocado - Sur stock Europe Zone 1 et Zone 2, nous consulter pour délai d'approvisionnement - Epuement/Stock depletion/Agotamiento del stock

BLOQUE BOUTON RESIST



10
ans

GARANTIE



00091276

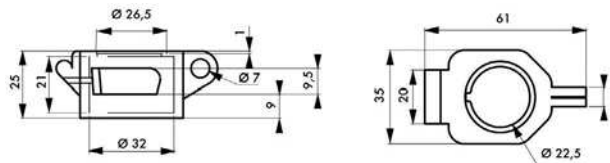

00091284

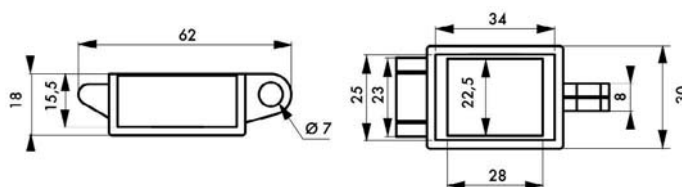

00091285

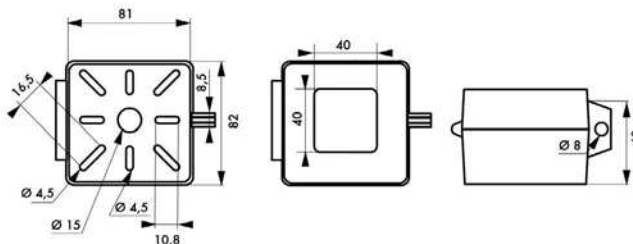

Description/Description/Descripción

Corps en résine transparente. Se fixe sur un bouton.
Transparent glass resin body. Can be fixed on the button.
Cuerpo de resina transparente. Se fija en un botón.

Finition/Finish/Acabado

Translucide
Translucent
Translucido

Utilisation/Use/Utilización

Possibilité de maintenir un équipement hors d'usage,
pendant des opérations de maintenance/réparation.
Possibility of keeping equipment out of use, during
maintenance/repair operations.

Posibilidad de mantener un equipo fuera de uso, durante
operaciones de mantenimiento/repación.

Designation	Boite	Colis.	Prix	Sachet	Colis.	Prix	Brochable					Colis.	Prix
							France	Euro 1	Euro 2	Euro 3	Euro 4		
BLOQUE BOUTON poussoir rond	00091276	1	-	-	-	-	-	-	-	-	-	-	-
BLOQUE BOUTON poussoir rectangulaire	00091284	1	-	-	-	-	-	-	-	-	-	-	-
BLOQUE BOUTON carré	00091285	1	-	-	-	-	-	-	-	-	-	-	-

⚠ Non stocké/Non-stored/Producto no estocado - ☑ Sur stock Europe Zone 1 et Zone 2, nous consulter pour délai d'approvisionnement - ☒ Epuisement/Stock depletion/Agotamiento del stock

Consignation BOUTON ROTATIF ET ARRÊT D'URGENCE RESIST



GARANTIE



00091282

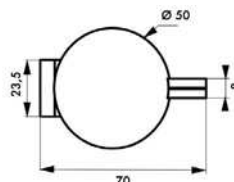
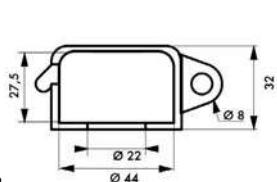

00091283

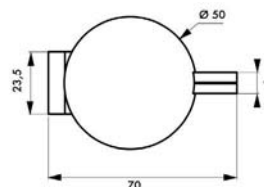
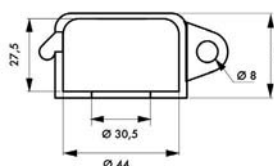

00091354

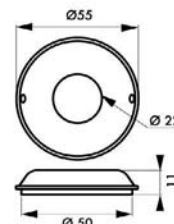
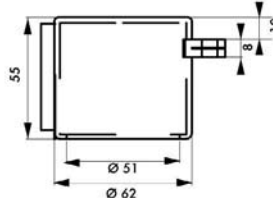
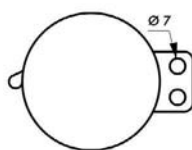

00091360

Description/Description/Descripción

Corps en résine transparente. Se fixe sur un bouton.
Transparent glass resin body. Can be fixed on the button.
Cuerpo de resina transparente. Se fija en un botón.

Finition/Finish/Acabado

Translucide. Cloche amovible (091354).
Translucent. Removable accessory (091354)
Translucido. Accesorio extraíble (091354).

Utilisation/Use/Utilización

Possibilité de maintenir un équipement hors d'usage, pendant des opérations de maintenance/réparation.
Possibility of keeping equipment out of use, during maintenance/repair operations.
Posibilidad de mantener un equipo fuera de uso, durante operaciones de mantenimiento/reparación.

Designation	Boite	Colis.	Prix	Sachet	Colis.	Prix	Brochable					Colis.	Prix
							France	Euro 1	Euro 2	Euro 3	Euro 4		
CONSIGNATION arrêt d'urgence Ø 22 mm	00091282	1	-	-	-	-	-	-	-	-	-	-	-
CONSIGNATION arrêt d'urgence Ø 30,5 mm	00091283	1	-	-	-	-	-	-	-	-	-	-	-
CONSIGNATION arrêt d'urgence amovible Ø 22 mm	00091354	1	-	-	-	-	-	-	-	-	-	-	-
Lot de 5 embases Ø 22 mm	00091360	1	-	-	-	-	-	-	-	-	-	-	-
Lot de 5 embases Ø 30,5 mm	00091361	1	-	-	-	-	-	-	-	-	-	-	-

Non stocké/Non-stored/Producto no estocado - Sur stock Europe Zone 1 et Zone 2, nous consulter pour délai d'approvisionnement - Epuement/Stock depletion/Agotamiento del stock

SAC DE CONSIGNATION DE TELECOMMANDE RESIST



GARANTIE



Description/Description/Descripción

Nylon / Nylon / Nylon

Finition/Finish/Acabado

Rouge / Red / Rojo

Utilisation/Use/Utilización

Télécommande de grue, pont roulant, prises de grande taille.

Locks out electrical connectors and remote controls.

Condenación de mando a distancia de gruas, puente-

Condamnación grúa

Designation	Boite	Colis.	Prix	Sachet	Colis.	Prix	Brochable					Colis.	Prix
							France	Euro 1	Euro 2	Euro 3	Euro 4		
Sac de consignation 450 mm	00091311	1	-	-	-	-	-	-	-	-	-	-	-

Consignation de PRISE RESIST



GARANTIE



00091279

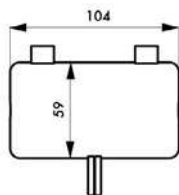
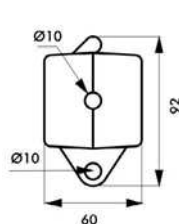

00091286

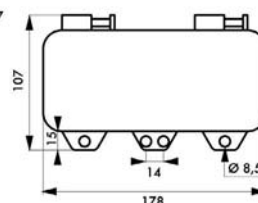
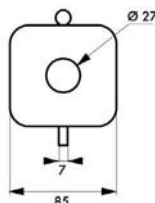

Designation	Boite	Colis.	Prix	Sachet	Colis.	Prix	Brochable					Colis.	Prix
							France	Euro 1	Euro 2	Euro 3	Euro 4		
CONSIGNATION pour prise 220V, VERROUILLAGE par 1 cadenas	00091279	1	-	-	-	-	-	-	-	-	-	-	-
CONSIGNATION pour prise 380V, VERROUILLAGE par 4 cadenas	00091286	1	-	-	-	-	-	-	-	-	-	-	-

⚠ Non stocké/Non-stored/Producto no estocado - ☑ Sur stock Europe Zone 1 et Zone 2, nous consulter pour délai d'approvisionnement - ☑ Epuisement/Stock depletion/Agotamiento del stock

Consignation de VANNE RESIST



GARANTIE



00091186

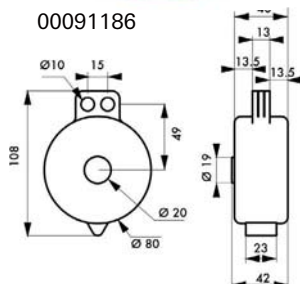

00091187

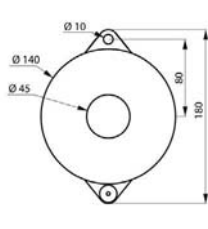

00091188

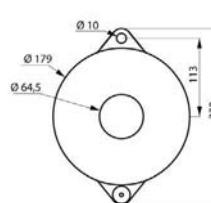

Références :
091186-091190



00091189

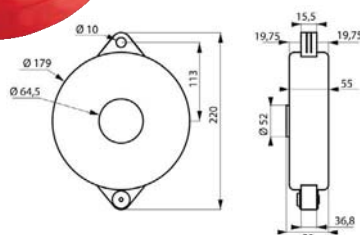

00091190

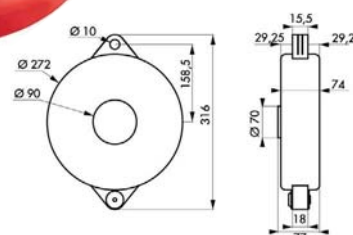

Description/Description/Descripción

Corps polypropylène non conducteur, protection diélectrique. Résistant à la chaleur, au froid, à l'abrasion, et aux produits chimiques. Verrouillage par cadenas. Pour vanne à volant.

Non-conductive polypropylene body. Dielectric protection. Impact, heat, corrosion and chemical resistance. Locking by padlock. For rotation valve.

Cuerpo polipropileno no conductor, protección dieléctrica. Resiste al calor, al frío, a la abrasión y a los productos químicos. Bloqueo por candado. Para válvula con volantes

Finition/Finish/Acabado

Rouge / Red / Rojo

Versión/Option/Versión

Disponible en 5 dimensions

5 sizes available

Disponible en 5 dimensions

Utilisation/Use/Utilización

Possibilité de maintenir un équipement hors d'usage, pendant des opérations de maintenance/réparation.

Possibility of keeping equipment out of use, during maintenance/repair operations.

Posibilidad de mantener un equipo fuera de uso, durante operaciones de mantenimiento/reparación.

Designation	Boite	Colis.	Prix	Sachet	Colis.	Prix	Brochable					Colis.	Prix
							France	Euro 1	Euro 2	Euro 3	Euro 4		
CONSIGNATION de vanne Ø 25 / 63 mm	00091186	1	-	-	-	-	-	-	-	-	-	-	-
CONSIGNATION de vanne Ø 63 / 127 mm	00091187	1	-	-	-	-	-	-	-	-	-	-	-
CONSIGNATION de vanne Ø 127 / 165 mm	00091188	1	-	-	-	-	-	-	-	-	-	-	-
CONSIGNATION de vanne Ø 165 / 254 mm	00091189	1	-	-	-	-	-	-	-	-	-	-	-
CONSIGNATION de vanne Ø 254 / 330 mm	00091190	1	-	-	-	-	-	-	-	-	-	-	-

Non stocké/Non-stored/Producto no estocado - Sur stock Europe Zone 1 et Zone 2, nous consulter pour délai d'approvisionnement - Epuisement/Stock depletion/Agotamiento del stock

Consignation de VANNE RESIST



GARANTIE

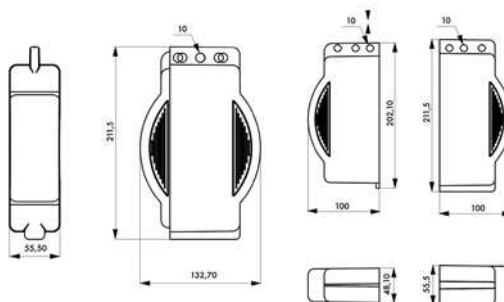

Description/Description/Descripción

Corps polypropylène non conducteur, protection diélectrique. Résistant à la chaleur, au froid, à l'abrasion, et aux produits chimiques. Verrouillage par cadenas. Pour vanne à volant.

Non-conductive polypropylene body. Dielectric protection. Impact, heat, corrosion and chemical resistance. Locking by padlock. For rotation valve.

Cuerpo polipropileno no conductor, protección dieléctrica. Resiste al calor, al frío, a la abrasión y a los productos químicos. Bloqueo por candado. Para válvula con volantes

Finition/Finish/Acabado

Rouge / Red / Rojo

Utilisation/Use/Utilización

Possibilité de maintenir un équipement hors d'usage, pendant des opérations de maintenance/réparation.

Possibility of keeping equipment out of use, during maintenance/repair operations.

Possibilidad de mantener un equipo fuera de uso, durante operaciones de mantenimiento/repación.

Designation	Boite	Colis.	Prix	Sachet	Colis.	Prix	Brochable					Colis.	Prix
							France	Euro 1	Euro 2	Euro 3	Euro 4		
CONSIGNATION de vanne ajustable Ø 25 / 165mm	00091237	1	-	-	-	-	-	-	-	-	-	-	-

Consignation de VANNE RESIST



GARANTIE

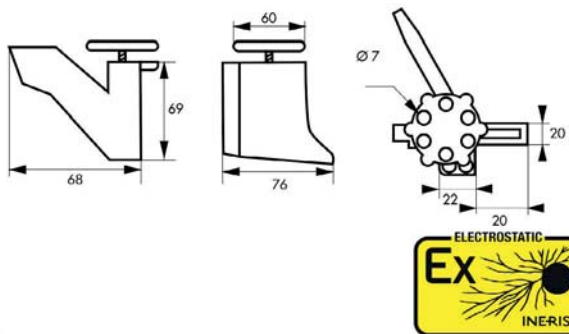

Références :
091326

Description/Description/Descripción

Corps polypropylène non conducteur. Pour vanne 1/4 de tour, plat largeur mini 15 mm, également 30 mm. Résistant à la chaleur, au froid, à l'abrasion, et aux produits chimiques. Verrouillage par cadenas.

Non-conductive polypropylene body. For ball valve 1/4 turn, handle width mini 15 mm, also 30 mm. Impact, heat, corrosion and chemical resistance. Locking by padlock.

Cuerpo polipropileno no conductor. Para válvula con 1/4 vuelta, manejar ancho 15 mm, también 30 mm. Resiste al calor, al frío, a la abrasión y a los productos químicos. Bloqueo por candado.

Finition/Finish/Acabado

Rouge / Red / Rojo

Utilisation/Use/Utilización

Possibilité de maintenir un équipement hors d'usage, pendant des opérations de maintenance/réparation.

Possibility of keeping equipment out of use, during maintenance/repair operations.

Possibilidad de mantener un equipo fuera de uso, durante operaciones de mantenimiento/repación.

Designation	Boite	Colis.	Prix	Sachet	Colis.	Prix	Brochable					Colis.	Prix
							France	Euro 1	Euro 2	Euro 3	Euro 4		
CONSIGNATION de vanne 1/4 de tour	00091197	1	-	-	-	-	-	-	-	-	-	-	

Consignation de VANNE RESIST

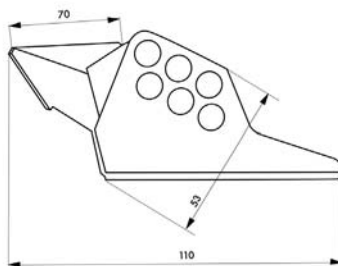

GARANTIE



Description/Description/Descripción

Corps acier peint. Résistance thermique. Verrouillage par cadenas. Pour vanne 1/4 de tour, plat largeur mini 20 mm, ajustable.

Steel body. Heat resistance. Locking by padlock. For ball valve 1/4 turn, handle width mini 20 mm, adjustable.

Cuerpo de acero. Calor resistencia. Bloqueo por candado. Para válvula con 1/4 vuelta, manejar ancho 20 mm, ajustable.

Finition/Finish/Acabado

Rouge / Red / Rojo

Utilisation/Use/Utilización

Possibilité de maintenir un équipement hors d'usage, pendant des opérations de maintenance/réparation.

Possibility of keeping equipment out of use, during maintenance/repair operations.

Posibilidad de mantener un equipo fuera de uso, durante operaciones de mantenimiento/reparación.

Designation	Boite	Colis.	Prix	Sachet	Colis.	Prix	Brochable					Colis.	Prix
							France	Euro 1	Euro 2	Euro 3	Euro 4		
CONSIGNATION vanne 1/4 de tour métal (1/4» à 1»)	00091238	1	-	-	-	-	-	-	-	-	-	-	-

Consignation de VANNE RESIST

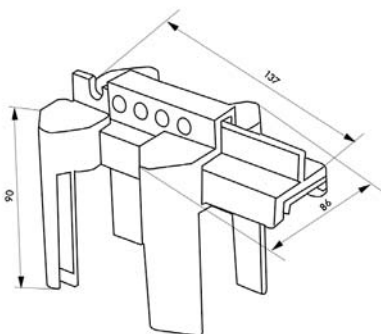

GARANTIE

Description/Description/Descripción

Corps polypropylène non conducteur. Pour vanne 1/4 de tour, plat largeur mini 15 mm à 30 mm. Résistant à la chaleur, au froid, à l'abrasion, et aux produits chimiques. Verrouillage par cadenas.

Non-conductive polypropylene body. For ball valve 1/4 turn, handle width mini 15 mm to 30 mm. Impact, heat, corrosion and chemical resistance. Locking by padlock.

Cuerpo polipropileno no conductor. Para válvula con 1/4 vuelta, manejar ancho de 15 mm a 30 mm. Resiste al calor, al frío, a la abrasión y a los productos químicos. Bloqueo por candado.

Finition/Finish/Acabado

Rouge / Red / Rojo

Utilisation/Use/Utilización

Possibilité de maintenir un équipement hors d'usage, pendant des opérations de maintenance/réparation.

Possibility of keeping equipment out of use, during maintenance/repair operations.

Posibilidad de mantener un equipo fuera de uso, durante operaciones de mantenimiento/reparación.

Designation	Boite	Colis.	Prix	Sachet	Colis.	Prix	Brochable					Colis.	Prix
							France	Euro 1	Euro 2	Euro 3	Euro 4		
CONSIGNATION vanne 1/4 de tour PP (1/2» à 2 1/2»)	00091239	1	-	-	-	-	-	-	-	-	-	-	

Non stocké/Non-stored/Producto no estocado - Sur stock Europe Zone 1 et Zone 2, nous consulter pour délai d'approvisionnement - Epuisement/Stock depletion/Agotamiento del stock

Consignation de VANNE RESIST

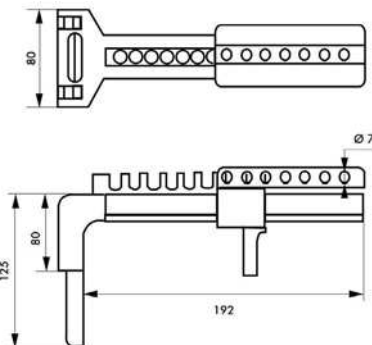

GARANTIE



Description/Description/Descripción

Corps polypropylène non conducteur. Résistant à la chaleur, au froid, à l'abrasion, et aux produits chimiques. Verrouillage par cadenas.

Non-conductive polypropylene body. Impact, heat, corrosion and chemical resistance. Locking by padlock.
Cuerpo polipropileno no conductor. Resiste al calor, al frío, a la abrasión y a los productos químicos. Bloqueo por candado.

Finition/Finish/Acabado

Rouge / Red / Rojo

Utilisation/Use/Utilización

Possibilité de maintenir un équipement hors d'usage, pendant des opérations de maintenance/réparation.
Possibility of keeping equipment out of use, during maintenance/repair operations.

Possibilidad de mantener un equipo fuera de uso, durante operaciones de mantenimiento/repación.

Designation	Boite	Colis.	Prix	Sachet	Colis.	Prix	Brochable					Colis.	Prix
							France	Euro 1	Euro 2	Euro 3	Euro 4		
CONSIGNATION de vanne 1/4 de tour	00091184	1	-	-	-	-	-	-	-	-	-	-	-

Consignation de VANNE RESIST

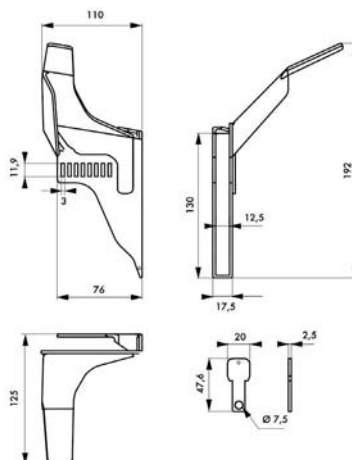

GARANTIE

Description/Description/Descripción

Corps acier peint. Résistance thermique. Verrouillage par cadenas. Pour vanne 1/4 de tour, plat largeur mini 20 mm, ajustable.

Steel body. Heat resistance. Locking by padlock. For ball valve 1/4 turn, handle width mini 20 mm, adjustable.
Cuerpo de acero. Calor resistencia. Bloqueo por candado. Para válvula con 1/4 vuelta, manejar ancho 20 mm, ajustable.

Finition/Finish/Acabado

Rouge / Red / Rojo

Utilisation/Use/Utilización

Possibilité de maintenir un équipement hors d'usage, pendant des opérations de maintenance/réparation.
Possibility of keeping equipment out of use, during maintenance/repair operations.

Possibilidad de mantener un equipo fuera de uso, durante operaciones de mantenimiento/repación.

Designation	Boite	Colis.	Prix	Sachet	Colis.	Prix	Brochable					Colis.	Prix
							France	Euro 1	Euro 2	Euro 3	Euro 4		
CONSIGNATION de vanne 1/4 de tour	00091196	1	-	-	-	-	-	-	-	-	-	-	

Consignation de VANNE RESIST

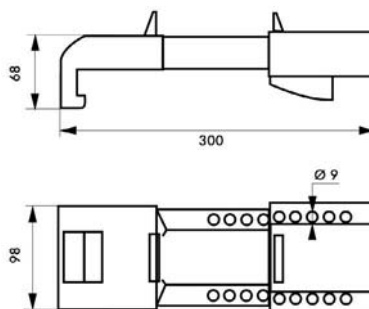

GARANTIE



Description/Description/Descripción

Corps polypropylène non conducteur. Résistant à la chaleur, au froid, à l'abrasion, et aux produits chimiques. Verrouillage par cadenas.

Non-conductive polypropylene body. Impact, heat, corrosion and chemical resistance. Locking by padlock.
Cuerpo polipropileno no conductor. Resiste al calor, al frío, a la abrasión y a los productos químicos. Bloqueo por candado.

Finition/Finish/Acabado

Rouge / Red / Rojo

Utilisation/Use/Utilización

Possibilité de maintenir un équipement hors d'usage, pendant des opérations de maintenance/réparation.
Possibility of keeping equipment out of use, during maintenance/repair operations.

Possibilidad de mantener un equipo fuera de uso, durante operaciones de mantenimiento/reparación.

Designation	Boite	Colis.	Prix	Sachet	Colis.	Prix	Brochable					Colis.	Prix
							France	Euro 1	Euro 2	Euro 3	Euro 4		
CONSIGNATION de vanne papillon	00091185	1	-	-	-	-	-	-	-	-	-	-	-

Consignation Universelle pour VANNE RESIST

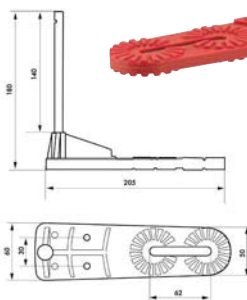
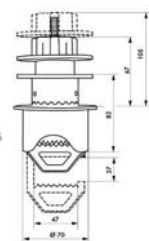

GARANTIE

Description/Description/Descripción

Corps polypropylène non conducteur. Résistant à la chaleur, au froid, à l'abrasion, et aux produits chimiques. Verrouillage par cadenas.

Non-conductive polypropylene body. Impact, heat, corrosion and chemical resistance. Locking by padlock.
Cuerpo polipropileno no conductor. Resiste al calor, al frío, a la abrasión y a los productos químicos. Bloqueo por candado.

Finition/Finish/Acabado

Rouge / Red / Rojo

Utilisation/Use/Utilización

Possibilité de maintenir un équipement hors d'usage, pendant des opérations de maintenance/réparation.
Possibility of keeping equipment out of use, during maintenance/repair operations.

Possibilidad de mantener un equipo fuera de uso, durante operaciones de mantenimiento/reparación.

Designation	Boite	Colis.	Prix	Sachet	Colis.	Prix	Brochable					Colis.	Prix
							France	Euro 1	Euro 2	Euro 3	Euro 4		
CÂBLE inox gainé PVC long. 2,50 m pour consignation universelle pour vanne	00091195	1	-	-	-	-	-	-	-	-	-	-	-
CORPS pour consignation universelle pour vanne	00091198	1	-	-	-	-	-	-	-	-	-	-	-
BRAS pour consignation universelle pour vanne	00091199	1	-	-	-	-	-	-	-	-	-	-	-

Ⓜ Non stocké/Non-stored/Producto no estocado - Ⓜ Sur stock Europe Zone 1 et Zone 2, nous consulter pour délai d'approvisionnement - Ⓜ Epuïsement/Stock depletion/Agotamiento del stock

Consignation BOUTEILLE DE GAZ RESIST



GARANTIE

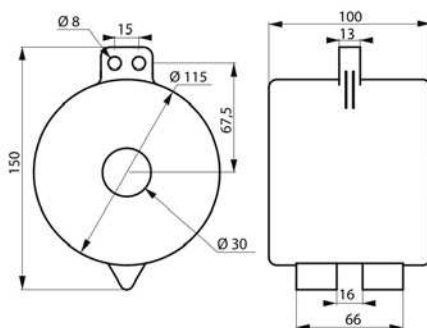

Description/Description/Descripción

Corps polypropylène non conducteur, protection diélectrique. Résistant à la chaleur, au froid, à l'abrasion, et aux produits chimiques. Verrouillage par cadenas.

Non-conductive polypropylene body. Dielectric protection. Impact, heat, corrosion and chemical resistance. Locking by padlock.

Cuerpo polipropileno no conductor, protección dieléctrica. Resiste al calor, al frío, a la abrasión y a los productos químicos. Bloqueo por candado.

Finition/Finish/Acabado

Rouge

Red

Rojo

Utilisation/Use/Utilización

Possibilité de maintenir un équipement hors d'usage, pendant des opérations de maintenance/réparation.

Possibility of keeping equipment out of use, during maintenance/repair operations.

Posibilidad de mantener un equipo fuera de uso, durante operaciones de mantenimiento/repación.

Designation	Boite	Colis.	Prix	Sachet	Colis.	Prix	Brochable					Colis.	Prix
							France	Euro 1	Euro 2	Euro 3	Euro 4		
CONSIGNATION de vanne de gaz sous pression	00091280	1	-	-	-	-	-	-	-	-	-	-	-

⚠ Non stocké/Non-stored/Producto no estocado - 📦 Sur stock Europe Zone 1 et Zone 2, nous consulter pour délai d'approvisionnement - 📦 Epuisement/Stock depletion/Agotamiento del stock

Consignation PNEUMATIQUE RESIST

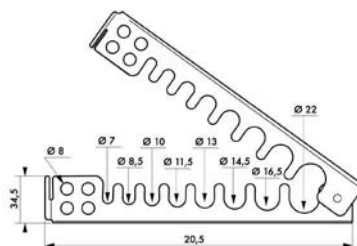

GARANTIE



Description/Description/Descripción

Acier inoxydable. Condamnation par 4 cadenas. Pour raccord Ø 19mm ,15,5mm,13,5mm,12mm, 10,5mm, 9,5mm, 8mm, 6,5mm

Stainless steel. Can be locked by 4 padlocks. Available with connection of Ø 19mm, 15,5mm, 13,5mm, 12mm, 10,5mm, 9,5mm, 8mm, 6,5 mm

Acero de inoxidable. Condenación por 4 candados. Para conexión Ø 19mm ,15,5mm,13,5mm,12mm, 10,5mm, 9,5mm, 8mm, 6,5mm

Finition/Finish/Acabado

Inox / Stainless steel / Inoxydable

Utilisation/Use/Utilización

S'adapte à tous types de raccord pneumatique pour empêcher le rebranchement à une source d'air sous pression.

Fits all kinds of pneumatic fitting to prevent reconnection to a pressurized air source.

Se adapta a todo tipo de accesorio neumático para evitar la reconexión a una fuente de aire a presión.

Designation	Boite	Colis.	Prix	Sachet	Colis.	Prix	Brochable					Colis.	Prix
							France	Euro 1	Euro 2	Euro 3	Euro 4		
CONSIGNATION raccords pneumatique	00091328	1	-	-	-	-	-	-	-	-	-	-	-

Consignation PNEUMATIQUE RESIST



GARANTIE

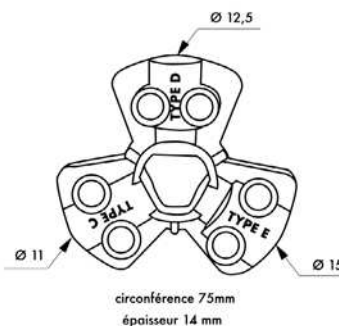

Description/Description/Descripción

Thermoplastique. Verrouillage par cadenas. Pour raccord pneumatique.

Thermoplastic. Locking by padlock. For pneumatic connection.

Termoplástico. Bloqueo por candado. Para conexión neumática.

Finition/Finish/Acabado

Rouge. / Red. / Rojo.

Utilisation/Use/Utilización

Possibilité de maintenir un équipement hors d'usage, pendant des opérations de maintenance/réparation.

Possibility of keeping equipment out of use, during maintenance/repair operations.

Posibilidad de mantener un equipo fuera de uso, durante operaciones de mantenimiento/reparación.

Designation	Boite	Colis.	Prix	Sachet	Colis.	Prix	Brochable					Colis.	Prix
							France	Euro 1	Euro 2	Euro 3	Euro 4		
CONSIGNATION raccords pneumatique nylon	00091236	1	-	-	-	-	-	-	-	-	-	-	-

Non stocké/Non-stored/Producto no estocado - Sur stock Europe Zone 1 et Zone 2, nous consulter pour délai d'approvisionnement - Epuïsement/Stock depletion/Agotamiento del stock

CÂBLE de consignation RESIST



GARANTIE

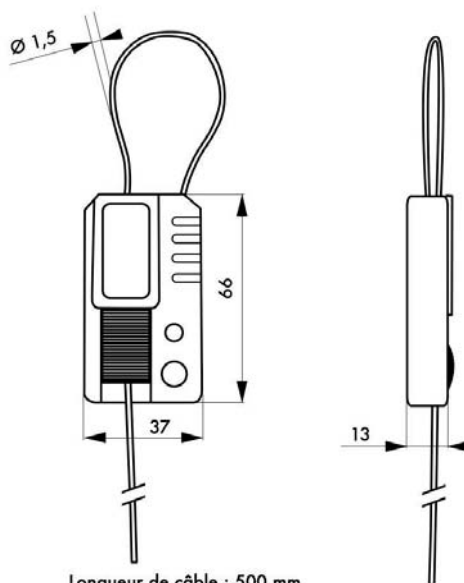

Longueur de câble : 500 mm

Description/Description/Descripción

Corps nylon. Câble acier tressé inoxydable isolé non conducteur. Longueur ajustable. Condamnation par cadenas. Le câble ne peut pas être enlever avant que les cadenas ne soient retirés.

Nylon body. Stainless steel cable with insulated cover. Adjustable length. Can be locked by padlocks. Control cannot be turned on until last worker's padlock is removed.

Cuerpo de nylon. Cable de acero inoxidable con cubierta aislante. Longitud ajustable. Puede cerrarse con candados. No se puede abrir hasta que no se hayan retirado todos los candados.

Finition/Finish/Acabado

Rouge.

Red.

Rojo.

Utilisation/Use/Utilización

Câble ajustable pour consigner simultanément plusieurs vannes, disjoncteurs.

Adjustable cable lockout for multiple valves, circuit breaker.

Bloqueo de cable ajustable para diversas válvulas y disyuntores.

Designation	Boite	Colis.	Prix	Sachet	Colis.	Prix	Brochable					Colis.	Prix
							France	Euro 1	Euro 2	Euro 3	Euro 4		
Mini câble de consignation Ø 1,5 x 500mm	00091235	1	-	-	-	-	-	-	-	-	-	-	-

⚠ Non stocké/Non-stored/Producto no estocado - 📦 Sur stock Europe Zone 1 et Zone 2, nous consulter pour délai d'approvisionnement - 🇪🇺 Epuisement/Stock depletion/Agotamiento del stock

CÂBLE de consignation RESIST



GARANTIE



Références :
091278

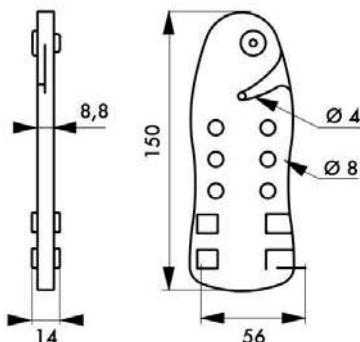
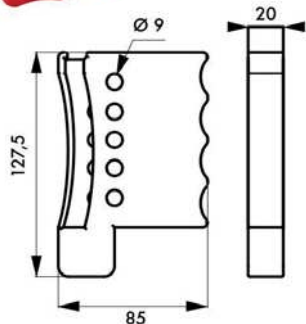

Description/Description/Descripción

Corps nylon. Câble acier tressé inoxydable isolé non conducteur. Longueur ajustable. Condamnation par cadenas. La mâchoire ne peut pas être ouverte avant que tous les cadenas ne soient retirés.

Nylon body. Stainless steel cable with insulated cover. Adjustable length. Can be locked by padlocks. Control cannot be turned on until last worker's padlock is removed.

Cuerpo de nylon. Cable de acero inoxidable con cubierta aislante. Longitud ajustable. Puede cerrarse con candados. No se puede abrir la mordaza hasta que no se hayan retirado todos los candados.

Finition/Finish/Acabado

Rouge

Red

Rojo

Version/Option/Versión

091278 / 091308 Condamnation par 5 cadenas.

Disponible en longueurs personnalisées sur demande. 091277 Condamnation par 6 cadenas.

091278/091308 Can be locked by 5 padlocks. Available in custom lengths on request. 091277 Can be locked by 6 padlocks.

091278/091308 Puede cerrarse con 5 candados.

Disponible en la costumbre longitudes bajo pedido. 091277 Puede cerrarse con 6 candados.

Utilisation/Use/Utilización

Câble ajustable pour consigner simultanément plusieurs vannes, disjoncteurs.

Adjustable cable lockout for multiple valves, circuit breaker.

Bloqueo de cable ajustable para diversas válvulas y disyuntores.

Designation	Boite	Colis.	Prix	Sachet	Colis.	Prix	Brochable					Colis.	Prix
							France	Euro 1	Euro 2	Euro 3	Euro 4		
CÂBLE de consignation ajustable Ø 4 mm longueur 2,00 m	00091277	1	-	-	-	-	-	-	-	-	-	-	-
CÂBLE de consignation ajustable Ø 3 mm longueur 1,80 m	00091278	1	-	-	-	-	-	-	-	-	-	-	-
CÂBLE de consignation ajustable Ø 3 mm longueur 0,60 m	00091308	1	-	-	-	-	-	-	-	-	-	-	-

Ⓜ Non stocké/Non-stored/Producto no estocado - 📦 Sur stock Europe Zone 1 et Zone 2, nous consulter pour délai d'approvisionnement - 📦 Epuisement/Stock depletion/Agotamiento del stock

Câble de consignation RESIST



GARANTIE



Description/Description/Descripción

Corps nylon. Câble acier tressé inoxydable isolé non conducteur. Longueur ajustable et blocage en position par rotation de la mollette. Condamnation par cadenas. La mâchoire ne peut pas être ouverte avant que tous les cadenas ne soient retirés.

Nylon body. Stainless steel cable with insulated cover. Adjustable length. Can be locked by padlocks. Control cannot be turned on until last worker's padlock is removed.

Cuerpo de nylon. Cable de acero inoxidable con cubierta aislante. Longitud ajustable. Puede cerrarse con candados. No se puede abrir la mordaza hasta que no se hayan retirado todos los candados.

Finition/Finish/Acabado

Rouge

Red

Rojo

Utilisation/Use/Utilización

Câble ajustable pour consigner simultanément plusieurs vannes, disjoncteurs .

Adjustable cable lockout for multiple valves, circuit breaker.

Bloqueo de cable ajustable para diversas válvulas y disyuntores.

Designation	Boite	Colis.	Prix	Sachet	Colis.	Prix	Brochable					Colis.	Prix
							France	Euro 1	Euro 2	Euro 3	Euro 4		
CÂBLE de consignation ajustable Ø 6 mm longueur 2,00 m	00091250	1	-	-	-	-	-	-	-	-	-	-	-

⚠ Non stocké/Non-stored/Producto no estocado - 📦 Sur stock Europe Zone 1 et Zone 2, nous consulter pour délai d'approvisionnement - 📦 Epuisement/Stock depletion/Agotamiento del stock

ARMOIRES DE STOCKAGE RESIST



GARANTIE



Références :
091290-091291



00091288



00091290

exemple
d'utilisation

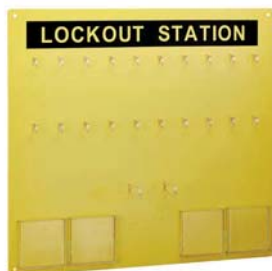

00091289



00091291

exemple
d'utilisation

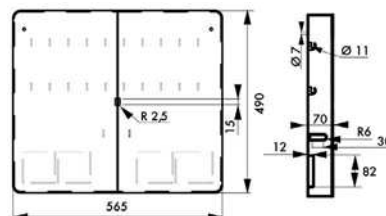
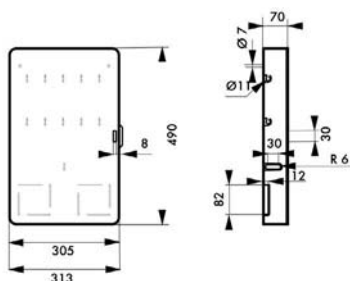

Description/Description/Descripción

ABS. Verrouillage par cadenas (091290/091291). Fixation murale.

ABS. Locking by padlock (091290/091291).

ABS. Bloqueo por candado (091290/091291). Montajes para pared.

Finition/Finish/Acabado

Jaune
yellow
amarillo

Version/Option/Versión

Capacité 10 ou 20 cadenas. Avec ou sans porte.

Capacity 10 or 20 padlocks. With or without door.

Capacidad 10 o 20 candados. Con o sin puerta.

Utilisation/Use/Utilización

Stockage de cadenas, mâchoire et étiquettes.

Storage

Para almacenar

Designation	Boite	Colis.	Prix	Sachet	Colis.	Prix	Brochable					Colis.	Prix
							France	Euro 1	Euro 2	Euro 3	Euro 4		
ARMOIRE sans porte 10 cadenas	00091288	1	-	-	-	-	-	-	-	-	-	-	-
ARMOIRE sans porte 20 cadenas	00091289	1	-	-	-	-	-	-	-	-	-	-	-
ARMOIRE avec porte 10 cadenas	00091290	1	-	-	-	-	-	-	-	-	-	-	-
ARMOIRE avec porte 20 cadenas	00091291	1	-	-	-	-	-	-	-	-	-	-	-

Non stocké/Non-stored/Producto no estocado - Sur stock Europe Zone 1 et Zone 2, nous consulter pour délai d'approvisionnement - Epuisement/Stock depletion/Agotamiento del stock

ARMOIRES DE STOCKAGE RESIST



GARANTIE



00091248



exemple
d'utilisation

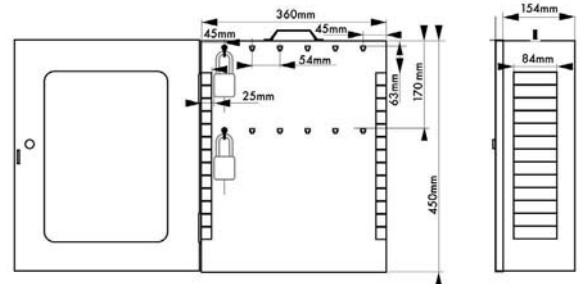

00091249



exemple
d'utilisation

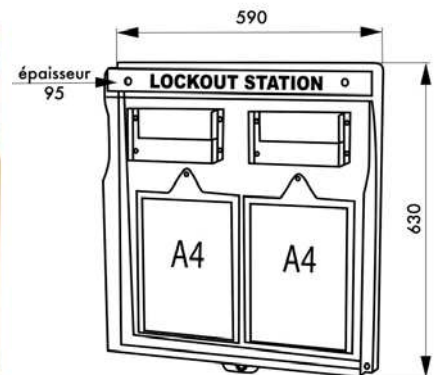

Description/Description/Descripción

Corps ABS. Verrouillage par cadenas. Fixation murale.
ABS body. Locking by padlock. Wall fixing.
Cuerpo ABS. Bloqueo por candado. Montajes para pared.

Finition/Finish/Acabado

Jaune.
Yellow.
Amarillo.

Utilisation/Use/Utilización

Stockage de cadenas, mâchoire et étiquettes.
Storage
Para almacenar

Designation	Boite	Colis.	Prix	Sachet	Colis.	Prix	Brochable					Colis.	Prix
							France	Euro 1	Euro 2	Euro 3	Euro 4		
ARMOIRE de consignation H450mm x L360mm x P155mm	00091248	1	-	-	-	-	-	-	-	-	-	-	-
ARMOIRE de consignation H630mm x L585mm x P100mm	00091249	1	-	-	-	-	-	-	-	-	-	-	-

⚠ Non stocké/Non-stored/Producto no estocado - 📦 Sur stock Europe Zone 1 et Zone 2, nous consulter pour délai d'approvisionnement - 📦 Epuisement/Stock depletion/Agotamiento del stock

STATION DE STOCKAGE CADENAS RESIST



GARANTIE



00091292

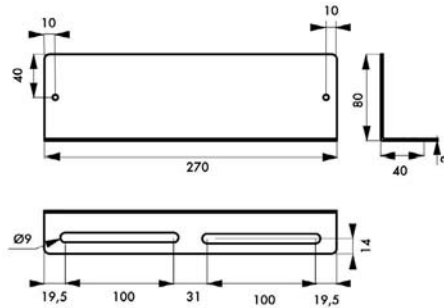

00091293

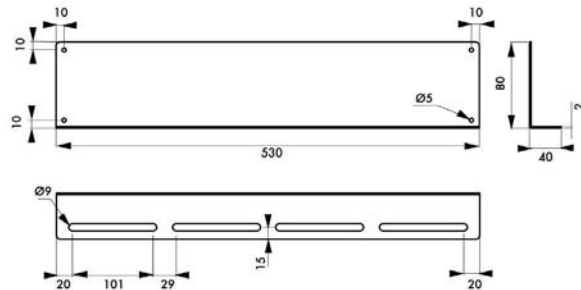

Description/Description/Descripción

Acier

Steel

Acero

Finition/Finish/Acabado

Rouge

Red

Rojo

Utilisation/Use/Utilización

Support de stockage mural pour cadenas

Storage padlocks

Soporte para almacenar candados

Designation	Boite	Colis.	Prix	Sachet	Colis.	Prix	Brochable					Colis.	Prix
							France	Euro 1	Euro 2	Euro 3	Euro 4		
STATION de stockage 10 cadenas long. 270 mm	00091292	1	-	-	-	-	-	-	-	-	-	-	-
STATION de stockage 20 cadenas long. 530 mm	00091293	1	-	-	-	-	-	-	-	-	-	-	-

⚠ Non stocké/Non-stored/Producto no estocado - 📦 Sur stock Europe Zone 1 et Zone 2, nous consulter pour délai d'approvisionnement - ⚠ Epuisement/Stock depletion/Agotamiento del stock

SAC DE TRANSPORT RESIST



GARANTIE



Description/Description/Descripción

Nylon

Nylon

Nylon

Finition/Finish/Acabado

Rouge

Red

Rojo

Utilisation/Use/Utilización

Transport de matériel pour équipe de maintenance

Carrying case for maintenance staff

Maletín de transporte para el personal de servicio

Designation	Boite	Colis.	Prix	Sachet	Colis.	Prix	Brochable					Colis.	Prix
							France	Euro 1	Euro 2	Euro 3	Euro 4		
Sac de transport	00091295	1	-	-	-	-	-	-	-	-	-	-	-
Trousse de transport	00091357	1	-	-	-	-	-	-	-	-	-	-	-
Sac banane - 3 compartiments	00091358	1	-	-	-	-	-	-	-	-	-	-	-
Sacoche de transport avec compartiments	00091359	1	-	-	-	-	-	-	-	-	-	-	-
Sac banane - 3 compartiments	00091294	1	-	-	-	-	-	-	-	-	-	-	-

⚠ Non stocké/Non-stored/Producto no estocado - ☑ Sur stock Europe Zone 1 et Zone 2, nous consulter pour délai d'approvisionnement - ☒ Epuisement/Stock depletion/Agotamiento del stock

RATELIER DE TRANSPORT RESIST



GARANTIE



exemple
d'utilisation

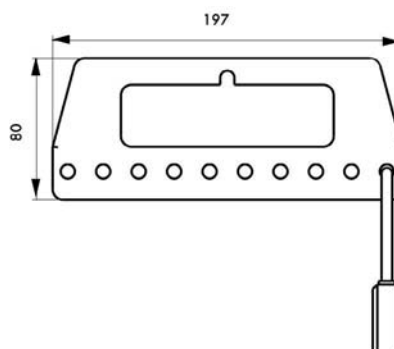

10 cadenas
029990



20 cadenas
029991

Description/Description/Descripción

Ratelier PVC. Livré sans cadenas.
PVC. Delivered without padlocks.
PVC. Entregado sin candado.

Utilisation/Use/Utilización

Transport et stockage
Carrying and stocking
Transporta y stock

Designation	Boite	Colis.	Prix	Sachet	Colis.	Prix	Brochable					Colis.	Prix
							France	Euro 1	Euro 2	Euro 3	Euro 4		
RATELIER pour 10 cadenas	00029990	1	-	-	-	-	-	-	-	-	-	-	-
RATELIER pour 20 cadenas	00029991	1	-	-	-	-	-	-	-	-	-	-	-

⚠ Non stocké/Non-stored/Producto no estocado - 📦 Sur stock Europe Zone 1 et Zone 2, nous consulter pour délai d'approvisionnement - ⚠ Epuisement/Stock depletion/Agotamiento del stock

RATELIER DE TRANSPORT RESIST



GARANTIE

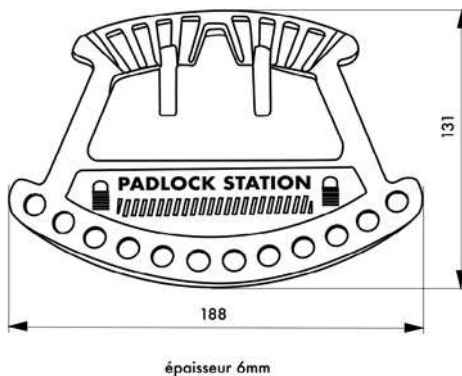

Description/Description/Descripción

Corps ABS non conducteur. Capacité 12 cadenas.
 Non-conductive ABS body. Capacity 12 padlocks.
 Cuerpo ABS no conductor. Capacidad 12 candados.

Finition/Finish/Acabado

Rouge.
 Red.
 Rojo.

Utilisation/Use/Utilización

Transport et stockage
 Carrying and stocking
 Transporta y stock

Designation	Boite	Colis.	Prix	Sachet	Colis.	Prix	Brochable					Colis.	Prix
							France	Euro 1	Euro 2	Euro 3	Euro 4		
RATELIER portatif nylon pour 12 cadenas	00091247	1	-	-	-	-	-	-	-	-	-	-	-

NS Non stocké/Non-stored/Producto no estocado - ☑ Sur stock Europe Zone 1 et Zone 2, nous consulter pour délai d'approvisionnement - E Epuisement/Stock depletion/Agotamiento del stock

ETIQUETTES de consignation

ECO



GARANTIE



Références :
091130-091131
091132-091133
091134-091135
091337

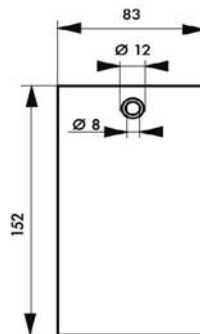

Description/Description/Descripción

Plastifiée, résistante à l'eau, à la graisse et aux salissures. Personnalizable (Nom, date ...). Avec œillet Ø 8mm.

Plastic sealed body tags, water and grease resistant. Customise (Name, date ...). 8mm diameter grommet.

Plastificada, resistente al agua, a la grasa y a la suciedad. Personalizable (Nombre, fecha...). Con ojete diámetro de 8mm

Finition/Finish/Acabado

Polyester. Polypropylène PP

Polyester. Polypropylene PP

Poliéster. Polypropylene PP

Utilisation/Use/Utilización

Etiquette d'identification visuelle lors d'une intervention sur un équipement.

Safety identification tag.

Etiqueta de identificación visual durante una intervención en un equipo.

Designation	Boite	Colis.	Prix	Sachet	Colis.	Prix	Brochable					Colis.	Prix
							France	Euro 1	Euro 2	Euro 3	Euro 4		
Lot de 10 étiquettes "Danger- Ne pas fermer" langue FR/GB/ES	00091130	1	-	-	-	-	-	-	-	-	-	-	-
Lot de 10 étiquettes "Danger - Ne pas toucher" langue FR/GB/ES	00091131	1	-	-	-	-	-	-	-	-	-	-	-
Lot de 10 étiquettes "Danger- Ne pas ouvrir" langue FR/GB/ES	00091132	1	-	-	-	-	-	-	-	-	-	-	-
Lot de 10 étiquettes "Danger- Ne pas mettre en marche en cours d'entretien" langue FR/GB/ES	00091133	1	-	-	-	-	-	-	-	-	-	-	-

Non stocké/Non-stored/Producto no estocado - Sur stock Europe Zone 1 et Zone 2, nous consulter pour délai d'approvisionnement - Epuement/Stock depletion/Agotamiento del stock

Designation	Boite	Colis.	Prix	Sachet	Colis.	Prix	Brochable					Colis.	Prix
							France	Euro 1	Euro 2	Euro 3	Euro 4		
Lot de 10 étiquettes "Danger- Défense d'enclencher" langue FR/GB/ES	00091134	1	-	-	-	-	-	-	-	-	-	-	-
Lot de 10 étiquettes "Danger- Hors service" langue FR/GB/ES	00091135	1	-	-	-	-	-	-	-	-	-	-	-
Lot de 10 étiquettes "Danger- Ne pas fermer" langue GB/PL/RU	00091296	1	-	-	-	-	-	-	-	-	-	-	-
Lot de 10 étiquettes "Danger - Ne pas toucher" langue GB/PL/RU	00091297	1	-	-	-	-	-	-	-	-	-	-	-
Lot de 10 étiquettes "Danger- Ne pas ouvrir" langue GB/PL/RU	00091298	1	-	-	-	-	-	-	-	-	-	-	-
Lot de 10 étiquettes "Danger- Ne pas mettre en marche en cours d'entretien" langue GB/PL/RU	00091299	1	-	-	-	-	-	-	-	-	-	-	-
Lot de 10 étiquettes "Danger- Défense d'enclencher" langue GB/PL/RU	00091300	1	-	-	-	-	-	-	-	-	-	-	-
Lot de 10 étiquettes "Danger- Hors service" langue GB/PL/RU	00091301	1	-	-	-	-	-	-	-	-	-	-	-
Lot de 10 étiquettes "Danger- Ne pas fermer" langue GB/RO/HU	00091330	1	-	-	-	-	-	-	-	-	-	-	-
Lot de 10 étiquettes "Danger - Ne pas toucher" langue GB/RO/HU	00091331	1	-	-	-	-	-	-	-	-	-	-	-
Lot de 10 étiquettes "Danger- Ne pas ouvrir" langue GB/RO/HU	00091332	1	-	-	-	-	-	-	-	-	-	-	-
Lot de 10 étiquettes "Danger- Ne pas mettre en marche en cours d'entretien" langue GB/RO/HU	00091333	1	-	-	-	-	-	-	-	-	-	-	-
Lot de 10 étiquettes "Danger- Défense d'enclencher" langue GB/RO/HU	00091334	1	-	-	-	-	-	-	-	-	-	-	-
Lot de 10 étiquettes "Danger- Hors service" langue GB/RO/HU	00091335	1	-	-	-	-	-	-	-	-	-	-	-
Lot de 5 étiquettes "Danger- Ne pas toucher" en polypropylène PP langue FR/GB/ES	00091337	1	-	-	-	-	-	-	-	-	-	-	-
Lot de 5 étiquettes "Danger- Ne pas toucher" en polypropylène PP langue GB/PL/RU	00091343	1	-	-	-	-	-	-	-	-	-	-	-
Lot de 5 étiquettes "Danger - Ne pas mettre en marche en cours d'entretien" en polypropylène PP langue GB/PL/RU	00091345	1	-	-	-	-	-	-	-	-	-	-	-
Lot de 5 étiquettes "Danger- Ne pas toucher" en polypropylène PP langue GB/RO/HU	00091349	1	-	-	-	-	-	-	-	-	-	-	-

Non stocké/Non-stored/Producto no estocado - Sur stock Europe Zone 1 et Zone 2, nous consulter pour délai d'approvisionnement - Epuisement/Stock depletion/Agotamiento del stock

ETIQUETTES de consignation RESIST



GARANTIE

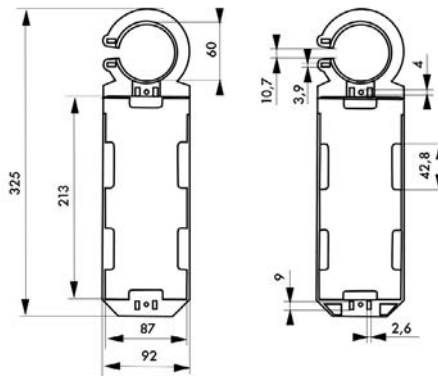

épaisseur 6mm

Description/Description/Descripción

Support ABS haute résistance.

High resistance ABS holder.

Soporte ABS alta resistencia.

Finition/Finish/Acabado

Étiquette verte : échaffaudage sécurisé peut être utilisé.

Étiquette jaune : échaffaudage en maintenance. Étiquette

rouge : interdiction d'utiliser l'échaffaudage.

Green label : secured scaffold, can be used. Yellow label

: scaffold under maintenance. Red label : the use of the scaffold is prohibited.

Etiqueta verde : andamio seguro, puede ser utilizado.

Etiqueta amarilla : andamio en mantenimiento. Etiqueta

roja : prohibición de utilizar el andamio.

Utilisation/Use/Utilización

Consignation d'échaffaudage .

Lock-out system for scaffolding.

Consignación de andamio.

Designation	Boîte	Colis.	Prix	Sachet	Colis.	Prix	Brochable					Colis.	Prix
							France	Euro 1	Euro 2	Euro 3	Euro 4		
Support Tag Echaffaudage avec étiquette 92 x 325mm	00091246	1	-	-	-	-	-	-	-	-	-	-	-

☒ Non stocké/Non-stored/Producto no estocado - ☑ Sur stock Europe Zone 1 et Zone 2, nous consulter pour délai d'approvisionnement - ☒ Epuisement/Stock depletion/Agotamiento del stock

Consignation / KIT MAINTENANCE ELECTRIQUE RESIST



10
ans

GARANTIE



Description/Description/Descripción

Nylon

Nylon

Nylon

Finition/Finish/Acabado

Rouge

Red

Rojo

Utilisation/Use/Utilización

Transport de matériel pour équipe de maintenance

Carrying case for maintenance staff

Maletin de transporte para el personal de servicio

Designation

KIT DE MAINTENANCE ELECTRIQUE

2 cadenas de CONSIGNATION 38 mm rouge, anse nylon Ø 6 mm, 1 clé, s'entrouvrant - MV5238RD

1 cadenas de CONSIGNATION 38 mm rouge, anse inox Ø 4,76 mm, 1 clé, s'en- trouvrant - MV5338RD

1 MÂCHOIRE de CONSIGNATION aluminium rouge pour 8 cadenas - 091304

1 ver- rouillage de mini disjonc- teur 11 mm nylon rouge - 091180

1 VERROUILLAGE de disjoncteur Universel nylon rouge - 091312

1 verrouillage de mini disjoncteur 12,7 mm maxi nylon rouge - 091313

1 VERROUILLAGE ajustable pour disjoncteur à levier - 091281

1 câble de CONSIGNATION ajustable gainé Ø 3 mm long. 1,80 m - 091278

1 lot de 10 étiquettes «DEFENSE D'EN- CLENCHE» - 091134

1 sac banane 3 compartiments - 091294

Boite	Colis.	Prix
00091362	1	-

⚠ Non stocké/Non-stored/Producto no estocado - 📦 Sur stock Europe Zone 1 et Zone 2, nous consulter pour délai d'approvisionnement - 📦 Epuisement/Stock depletion/Agotamiento del stock

Consignation / KIT MAINTENANCE ÉLECTRIQUE RESIST



GARANTIE



Références :
091312

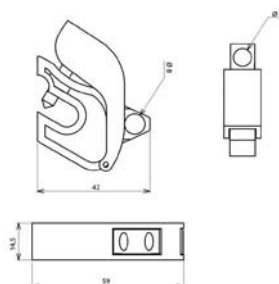

Utilisation/Use/Utilización

Transport de matériel pour équipe de maintenance

Carrying case for maintenance staff

Maletín de transporte para el personal de servicio

Designation

KIT DE MAINTENANCE ELECTRIQUE N°1 «le VERROUILLAGE universel»
5 VERROUILLAGEs de disjoncteur Universel nylon rouge - 091312

Boite	Colis.	Prix
00291151	1	-

Consignation / KIT MAINTENANCE ÉLECTRIQUE RESIST



GARANTIE



Références :
091312-091180
091313-091281



Utilisation/Use/Utilización

Transport de matériel pour équipe de maintenance

Carrying case for maintenance staff

Maletín de transporte para el personal de servicio

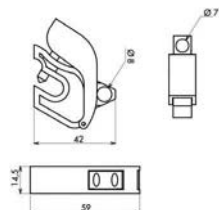

00091312

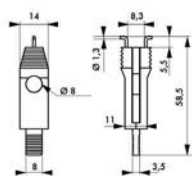

00091180

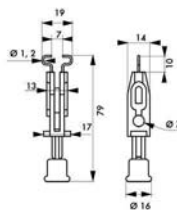

00091313

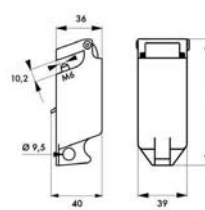

00091281

Designation

KIT DE MAINTENANCE ELECTRIQUE N°2 «l'indispensable de l'électricien»
1 VERROUILLAGE de disjoncteur Universel nylon rouge - 091312
1 VERROUILLAGE de mini disjoncteur 11 mm nylon rouge - 091180
1 VERROUILLAGE de mini disjoncteur 12,7 mm maxi nylon rouge - 091313
1 VERROUILLAGE ajustable pour disjoncteur à levier - 091281

Boite	Colis.	Prix
00291152	1	-

Consignation / KIT MAINTENANCE ÉLECTRIQUE RESIST



10
ans

GARANTIE

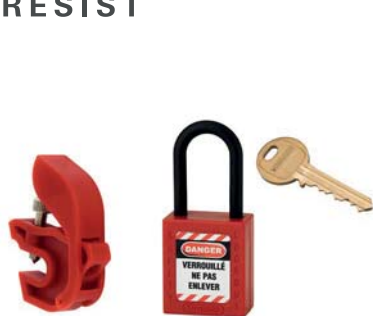

00091312

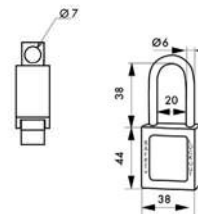

005238RD

Utilisation/Use/Utilización

Transport de matériel pour équipe de maintenance

Carrying case for maintenance staff

Maletín de transporte para el personal de servicio

Designation

KIT DE MAINTENANCE ELECTRIQUE N°3 «la base de la CONSIGNATION électrique»

1 VERROUILLAGE de disjoncteur Universel nylon rouge - 091312

1 cadenas de CONSIGNATION 38 mm rouge, anse nylon Ø 6 mm

1 clé - 005238RD 1 étiquette «DEFENSE D'ENCLENCHER»- 091128

Boite	Colis.	Prix
00291153	1	-

Consignation / KIT MAINTENANCE ÉLECTRIQUE RESIST



10
ans

GARANTIE

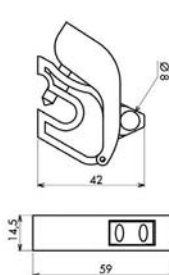

00091312

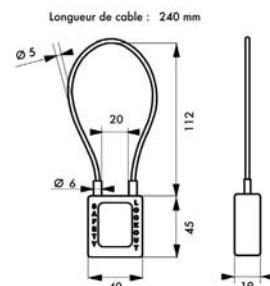
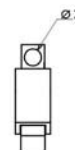

005624RD

Utilisation/Use/Utilización

Transport de matériel pour équipe de maintenance

Carrying case for maintenance staff

Maletín de transporte para el personal de servicio

Designation

KIT DE MAINTENANCE ELECTRIQUE N°4 «l'indispensable de l'électricien»

1 VERROUILLAGE de disjoncteur Universel nylon rouge - 091312

1 cadenas de CONSIGNATION 38 mm rouge, câble inox gainé Ø 6x240 mm

1 clé - 005624RD 1 étiquette «DEFENSE D'ENCLENCHER»- 091128

Boite	Colis.	Prix
00291154	1	-

⚠ Non stocké/Non-stored/Producto no estocado - 📦 Sur stock Europe Zone 1 et Zone 2, nous consulter pour délai d'approvisionnement - 📦 Epuisement/Stock depletion/Agotamiento del stock

Consignation / KIT MAINTENANCE ÉLECTRIQUE RESIST



GARANTIE

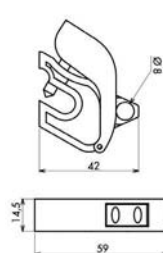

00091312

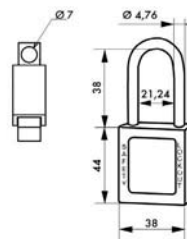

005338RD

Utilisation/Use/Utilización

Transport de matériel pour équipe de maintenance

Carrying case for maintenance staff

Maletín de transporte para el personal de servicio

Designation

KIT DE MAINTENANCE ELECTRIQUE N°5 «la base de la CONSIGNATION électrique»

1 VERROUILLAGE de disjoncteur Universel nylon rouge - 091312

1 cadenas de CONSIGNATION 38 mm rouge, anse inox Ø 4,76 mm

1 clé - 005338RD 1 étiquette «DEFENSE D'ENCLANCHER»- 091128

Boite	Colis.	Prix
00291155	1	-

Consignation / KIT MAINTENANCE ÉLECTRIQUE RESIST



GARANTIE



Ouverture par même clé

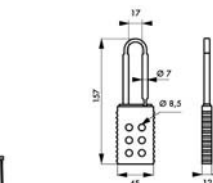

00091193

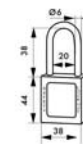

MV5238RD

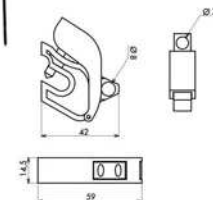

00091312

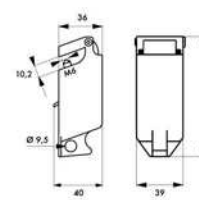

00091281

Utilisation/Use/Utilización

Transport de matériel pour équipe de maintenance

Carrying case for maintenance staff

Maletín de transporte para el personal de servicio

Designation

KIT DE MAINTENANCE ELECTRIQUE N°6 «l'essentiel de l'électricien»

1 VERROUILLAGE de disjoncteur Universel nylon rouge - 091312

1 VERROUILLAGE ajustable pour disjoncteur à levier - 091281

1 Morillon en nylon pour 6 cadenas - 091193

2 cadenas de CONSIGNATION 38 mm rouge, anse nylon Ø 6 mm

1 clé, s'ouvrant - MV5238RD 2 étiquettes «DEFENSE D'ENCLANCHER»- 091128

1 Trousse de transport - 091357

Boite	Colis.	Prix
00591156	1	-

Consignation / KIT CADENAS RESIST



GARANTIE



Références :
00291156



Ouverture par même clé

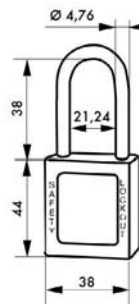

Utilisation/Use/Utilización

Transport de matériel pour équipe de maintenance

Carrying case for maintenance staff

Maletín de transporte para el personal de servicio

Designation

KIT DE CONSIGNATION CADENAS ANSE INOX

3 cadenas de CONSIGNATION 38 mm rouge, anse inox Ø 4,76 mm, 1 clé - MV005338RD

Boite	Colis.	Prix
00291156	1	-

Consignation / KIT CADENAS RESIST



GARANTIE



Ouverture par même clé

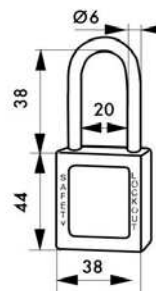

Utilisation/Use/Utilización

Transport de matériel pour équipe de maintenance

Carrying case for maintenance staff

Maletín de transporte para el personal de servicio

Designation

KIT DE CONSIGNATION CADENAS ANSE NYLON

3 cadenas de CONSIGNATION 38 mm rouge, anse nylon Ø 6 mm, 1 clé - MV005238RD

Boite	Colis.	Prix
00291158	1	-

⚠ Non stocké/Non-stored/Producto no estocado - 📦 Sur stock Europe Zone 1 et Zone 2, nous consulter pour délai d'approvisionnement - ⚠ Epuisement/Stock depletion/Agotamiento del stock

Consignation / KIT MAINTENANCE PLOMBERIE RESIST



GARANTIE

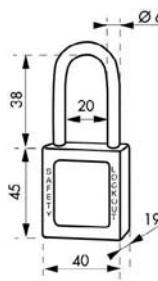
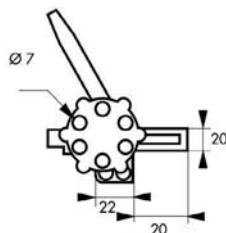
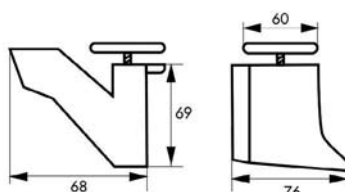

Description/Description/Descripción

Corps polypropylène non conducteur. Pour vanne 1/4 de tour, plat largeur mini 15 mm, également 30 mm. Résistant à la chaleur, au froid, à l'usure, et aux produits chimiques. Verrouillage par cadenas.

Non-conductive polypropylene body. For ball valve, handle width mini 15 mm, also 30 mm. Impact, heat, corrosion and chemical resistance. Locking by padlock.

Cuerpo polipropileno no conductor. Para válvula con media vuelta, manejar ancho 15 mm, también 30 mm. Resiste al calor, al frío, a la abrasión y a los productos químicos. Bloqueo por candado.

Finition/Finish/Acabado

Rouge

Red

Rojo

Utilisation/Use/Utilización

Possibilité de maintenir un équipement en position ouverte ou fermée pendant des opérations de maintenance / réparation.

Protection against accidental valve opening.

Posibilidad de mantener un equipo fuera de uso, durante operaciones de mantenimiento/repelación.

Designation

KIT DE MAINTENANCE PLOMBERIE «la base de la CONSIGNATION plomberie »
1 CONSIGNATION de vanne 1/4 de tour - 091197
1 cadenas de CONSIGNATION 40 mm anse acier Ø 6 X 38 mm
1 clé - 0091262 1 étiquette «HORS SERVICE»- 091129

Boite	Colis.	Prix
00391159	1	-

⊗ Non stocké/Non-stored/Producto no estocado - ⊗ Sur stock Europe Zone 1 et Zone 2, nous consulter pour délai d'approvisionnement - ⊗ Epuement/Stock depletion/Agotamiento del stock

BOITE A CLÉ DE SECOURS

ECO



GARANTIE



X 2

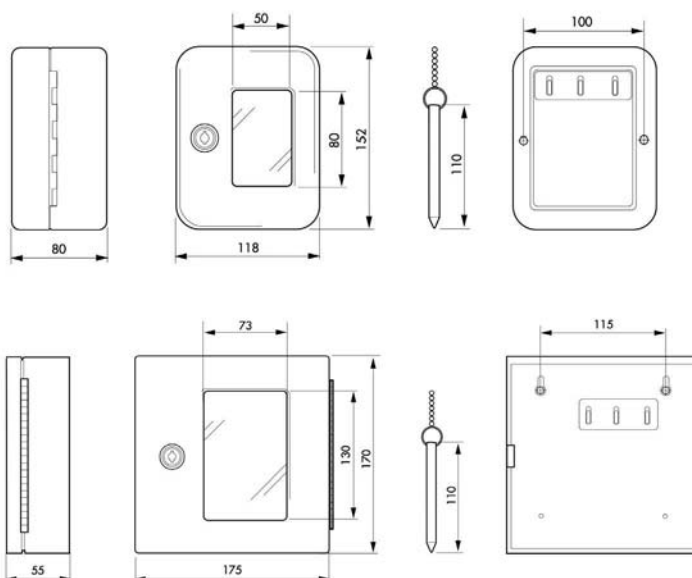

Description/Description/Descripción

Coffre acier. Vitre interchangeable. Chainette avec marteau brise glace. 3 crochets. Fermeture par batteuse avec 2 clés. Fixation murale (accessoires fournis).

Steel case. Removable glass. With chain and glass breaker hammer. 3 hooks. Locking thanks to Cam-Lock with 2 keys. Wall mounting (accessories supplied).

Carcasa de chapa de acero. Con vidrio intercambiable y martillon conectado con cadena. 3 ganchos. Cierre por cerradura con leva con 2 llaves. Instalación en la pared. (accesorios suministrados).

Finition/Finish/Acabado

Laqué epoxy Rouge. RAL 3002

Red epoxy lacquered. RAL 3002

Lacado epoxy rojo. Ral 3002

Designation	Boite	Colis.	Prix	Sachet	Colis.	Prix	Brochable					Colis.	Prix
							France	Euro 1	Euro 2	Euro 3	Euro 4		
BOITE À CLÉ DE SECOURS murale - 2 clés - 152 x 118 x 80 mm	00012236	1	-	-	-	-	-	-	-	-	-	-	-
BOITE À CLÉS DE SECOURS murale - 2 clés - 170 x 175 x 55 mm	00012237	1	-	-	-	-	-	-	-	-	-	-	-

⚠ Non stocké/Non-stored/Producto no estocado - 📦 Sur stock Europe Zone 1 et Zone 2, nous consulter pour délai d'approvisionnement - 📦 Epuisement/Stock depletion/Agotamiento del stock

Plomb scellé PLASTIQUE RESIST



GARANTIE

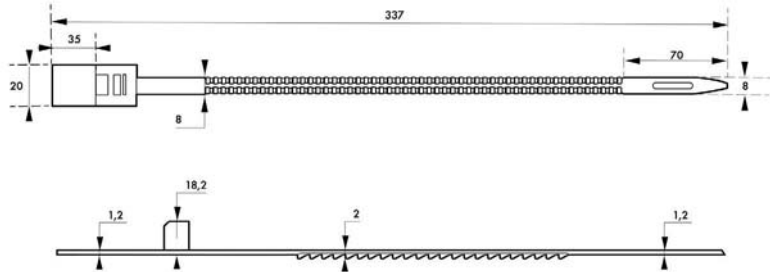
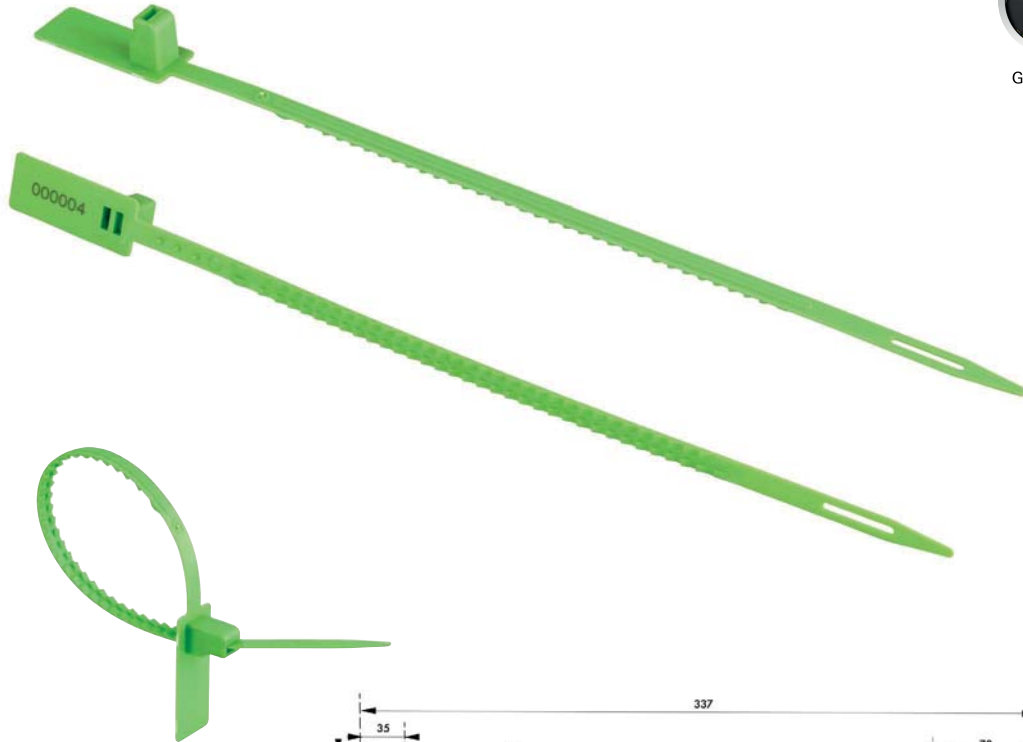

Description/Description/Descripción

Polypropylène, système de fermeture cranté à serrage progressif.

Polypropylene, locking system with progressive tightening.

Polipropileno, con sistema de muescas de apriete progresivo.

Finition/Finish/Acabado

Couleurs assorties : Bleu, rouge, vert.

Assorted colors: Blue, red, green.

Colores surtidos: Azul, rojo, verde.

Version/Option/Versión

Possibilité de personnalisation (nous consulter).

Possibility of personalisation (on request).

Possibilidad de personalización (consultar).

Designation	Boite	Colis.	Prix	Sachet	Colis.	Prix	Brochable					Colis.	Prix
							France	Euro 1	Euro 2	Euro 3	Euro 4		
PLOMB scellé plastique 345mm - sachet de 100 pièces	-	-	-	00991390	10	-	-	-	-	-	-	-	-

Ⓜ Non stocké/Non-stored/Producto no estocado - ☑ Sur stock Europe Zone 1 et Zone 2, nous consulter pour délai d'approvisionnement - ☒ Epuisement/Stock depletion/Agotamiento del stock

Plomb scellé CADENAS RESIST



GARANTIE

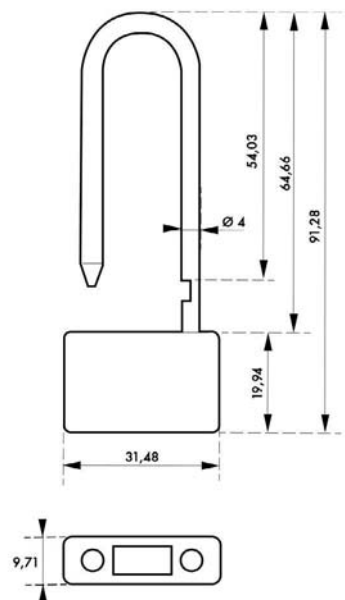

Description/Description/Descripción

Corps ABS. Anse acier galvanisé. Résistant à la corrosion.

ABS body. Galvanized steel shackle. Corrosion resistant.

Cuerpo de ABS. Arco de acero galvanizado. Resistente a la corrosión.

Finition/Finish/Acabado

Couleurs assorties.

Assorted colors.

Colores surtidos.

Version/Option/Versión

Possibilité de personnalisation (nous consulter).

Possibility of personalisation (on request).

Posibilidad de personalización (consultar).

Utilisation/Use/Utilización

Tous types de conteneurs, portes, services postaux etc...

All types of containers, doors, postal services etc...

Todo tipo de contenedores, puertas, servicios postales, etc..

Designation	Boite	Colis.	Prix	Sachet	Colis.	Prix	Brochable					Colis.	Prix
							France	Euro 1	Euro 2	Euro 3	Euro 4		
PLOMB scellé cadenas	00091392	100	-	-	-	-	-	-	-	-	-	-	-

⚠ Non stocké/Non-stored/Producto no estocado - 📦 Sur stock Europe Zone 1 et Zone 2, nous consulter pour délai d'approvisionnement - 📦 Epuisement/Stock depletion/Agotamiento del stock

Scellé MÉTALLIQUE RESIST



GARANTIE

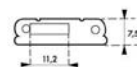
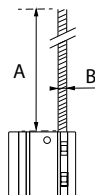
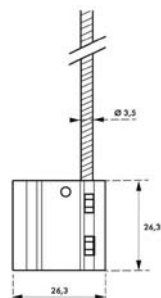
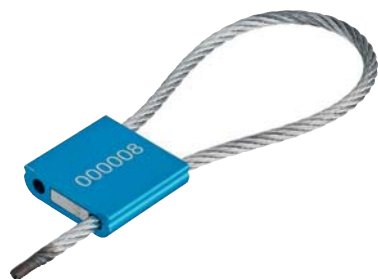

	A	B
991380	500	3,5
991381	330	5
991382	1000	5
991383	125	1,8
991384	140	1,8
991385	270	1,8
991386	280	1,8
991387	200	3
991388	300	1,5

Description/Description/Descripción

Corps aluminium.câble acier zingué. Fermeture pas serrage/traction. Détachable par coupe-boulon. Conforme à la norme ISO 17712/2013- grade H.
Aluminum body. Galvanized steel cable. Closing by tightening/pulling. Detachable by bolt cutter. Conforms to ISO 17712/2013 - grade H.

Cuerpo de aluminio. Cable de acero galvanizado. Cierre por apriete/tiro. Desmontable por medio de un cortador de pernos. Cumple con la norma ISO 17712/2013 - grado H.

Finition/Finish/Acabado

Couleurs assorties : Bleu, rouge, orange, vert.

Assorted colors: Blue, red, orange, green.

Colores surtidos: Azul, rojo, naranja, verde.

Version/Option/Versión

Possibilité de personnalisation (nous consulter).

Possibility of personalisation (on request).

Posibilidad de personalización (consultar).

Utilisation/Use/Utilización

Sécurisation de tous types de conteneurs, camions, etc...

Securing of all types of containers, trucks...

Aseguramiento de todo tipo de contenedores, camiones...

Designation	Boite	Colis.	Prix	Sachet	Colis.	Prix	Brochable					Colis.	Prix
							France	Euro 1	Euro 2	Euro 3	Euro 4		
SCELLÉ métallique 3,5x500mm - sachet de 25 pièces	-	-	-	00991380	25	-	-	-	-	-	-	-	-
SCELLÉ métallique 5x330mm - sachet de 25 pièces	-	-	-	00991381	20	-	-	-	-	-	-	-	-
SCELLÉ métallique 5x1000mm - sachet de 25 pièces	-	-	-	00991382	40	-	-	-	-	-	-	-	-
SCELLÉ métallique 1,8x125mm - sachet de 25 pièces	-	-	-	00991383	40	-	-	-	-	-	-	-	-
SCELLÉ métallique 1,8x270mm - sachet de 25 pièces	-	-	-	00991385	40	-	-	-	-	-	-	-	-
SCELLÉ métallique 1,8x280mm - sachet de 25 pièces	-	-	-	00991386	40	-	-	-	-	-	-	-	-
SCELLÉ métallique 3x200mm - sachet de 25 pièces	-	-	-	00991387	40	-	-	-	-	-	-	-	-
SCELLÉ métallique 1,5x300mm - sachet de 25 pièces	-	-	-	00991388	40	-	-	-	-	-	-	-	-

Non stocké/Non-stored/Producto no estocado - Sur stock Europe Zone 1 et Zone 2, nous consulter pour délai d'approvisionnement - Epuisement/Stock depletion/Agotamiento del stock

Scellé MÉTALLIQUE RESIST



GARANTIE

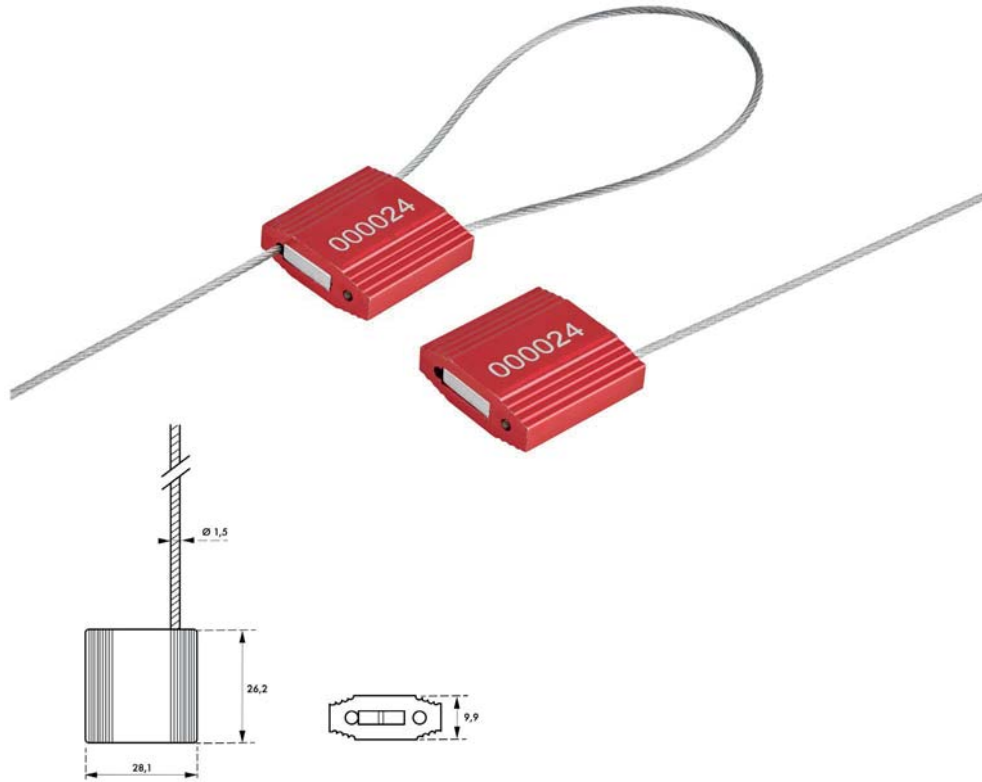

Description/Description/Descripción

Corps aluminium.câble acier zingué. Fermeture pas serrage/traction. Détachable par coupe-boulon.
Conforme à la norme ISO 17712/2013- grade H.
Aluminum body. Galvanized steel cable. Closing by tightening/pulling. Detachable by bolt cutter. Conforms to ISO 17712/2013 - grade H.
Cuerpo de aluminio. Cable de acero galvanizado. Cierre por apriete/tiro. Desmontable por medio de un cortador de pernos. Cumple con la norma ISO 17712/2013 - grado H.

Finition/Finish/Acabado

Couleurs assorties : Bleu, rouge, orange, vert.
Assorted colors: Blue, red, orange, green.
Colores surtidos: Azul, rojo, naranja, verde.

Version/Option/Versión

Possibilité de personnalisation (nous consulter).
Possibility of personalisation (on request).
Posibilidad de personalización (consultar).

Utilisation/Use/Utilización

Sécurisation de tous types de conteneurs, camions, etc...
Securing of all types of containers, trucks...
Aseguramiento de todo tipo de contenedores, camiones...

Designation	Boite	Colis.	Prix	Sachet	Colis.	Prix	Brochable					Colis.	Prix
							France	Euro 1	Euro 2	Euro 3	Euro 4		
SCELLÉ métallique 1,5x240mm - sachet de 25 pièces	-	-	-	00991389	40	-	-	-	-	-	-	-	-

⚠ Non stocké/Non-stored/Producto no estocado - 📦 Sur stock Europe Zone 1 et Zone 2, nous consulter pour délai d'approvisionnement - 📦 Epuisement/Stock depletion/Agotamiento del stock

Scellé clou lockseal RESIST



GARANTIE

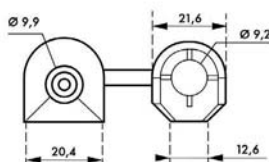
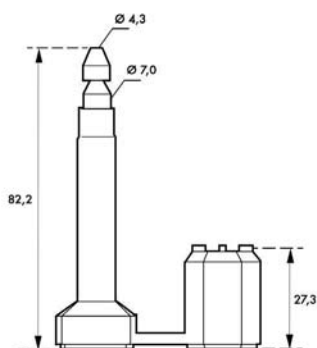

Description/Description/Descripción

Corps ABS. Clou en acier zingué. Conforme à la norme ISO 17712/2013- grade H.

ABS body. Zinc plated steel head nail. Conforms to ISO 17712/2013- grade H.

Cuerpo de ABS. Clavo de acero galvanizado. Cumple con la norma ISO 17712/2013 - grado H.

Finition/Finish/Acabado

Couleurs assorties.

Assorted colors.

Colores surtidos.

Version/Option/Versión

Possibilité de personnalisation (nous consulter).

Possibility of personalisation (on request).

Posibilidad de personalización (consultar).

Utilisation/Use/Utilización

Sécurisation de tous types de conteneurs, camions, etc...

Securing of all types of containers, trucks...

Aseguramiento de todo tipo de contenedores, camiones...

Designation	Boite	Colis.	Prix	Sachet	Colis.	Prix	Brochable					Colis.	Prix
							France	Euro 1	Euro 2	Euro 3	Euro 4		
SCELLÉ clou lockseal	00091391	25	-	-	-	-	-	-	-	-	-	-	-



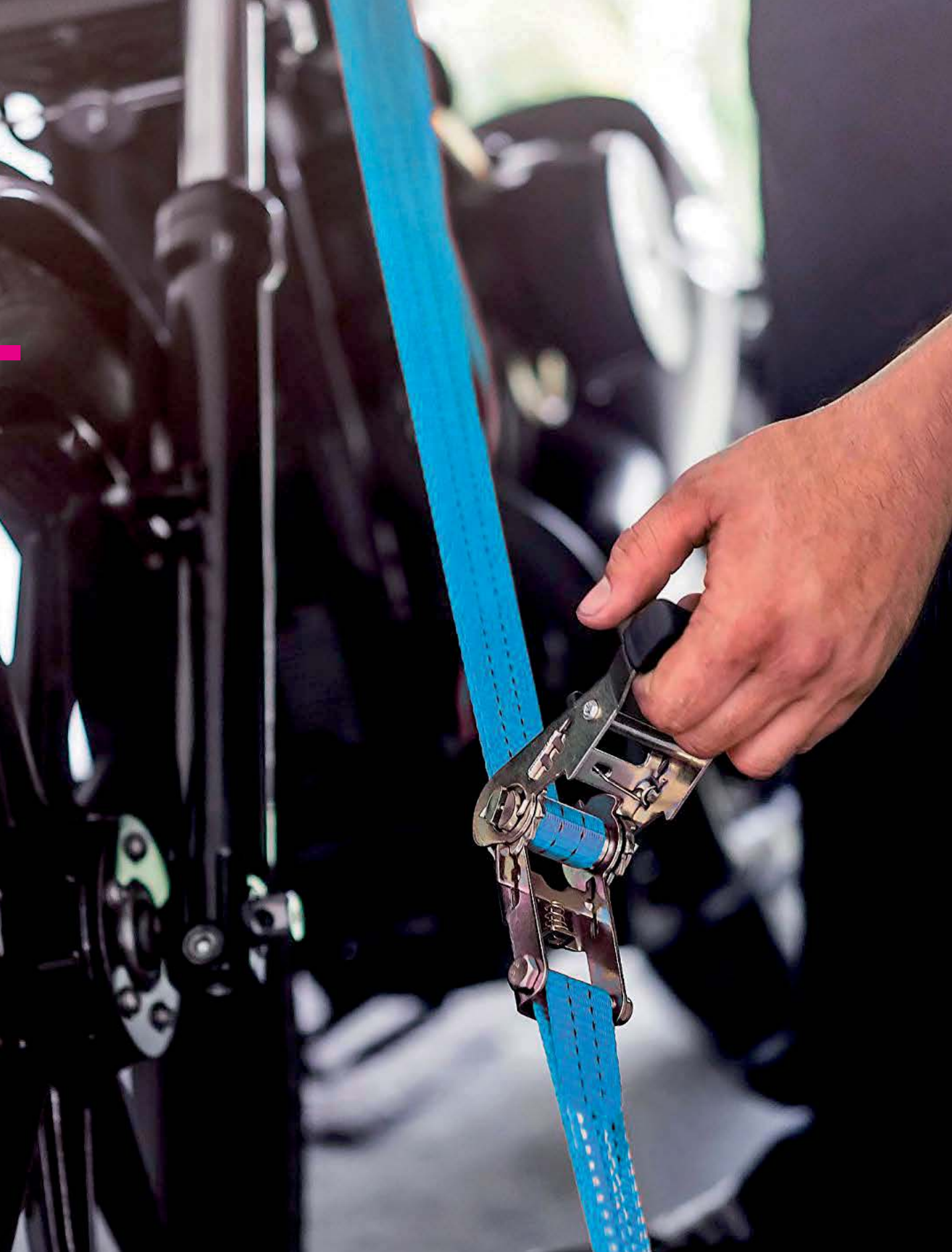



Non stocké/Non-stored/Producto no estocado - Sur stock Europe Zone 1 et Zone 2, nous consulter pour délai d'approvisionnement - Epuisement/Stock depletion/Agotamiento del stock





Sandows

ECO
PROTECT
 RESIST

SANGLE

Sangle de bagage		250
Sangle à boucle		251
Sangle à cliquet		252
Sangle à cliquet + crochet S		253
Sangle à cliquet AUTOMATIQUE		256
Sangle à cliquet + crochet JJ		257

SANDOW

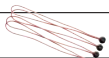
Sangle à crochet		261
Sangle pieuvre à crochet		263
Sangle à crochet		264
Sangle à boule		267

ANNEAU

Anneau arrimage		268
-----------------	---	-----



Sangle / DE BAGAGE ECO



GARANTIE

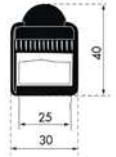
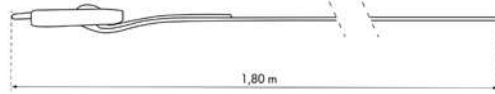

Description/Description/Descripción

Sangle polyester, boucle de serrage polyamide.
Polyester strap, plastic buckle.
Correa poliéster, hebilla de plástico

Finition/Finish/Acabado

Rouge
Red.
Rojo.

Utilisation/Use/Utilización

Sangle de serrage.
Lashing strap.
Correa de apriete

Designation	Boite	Colis.	Prix	Sachet	Colis.	Prix	Brochable					Colis.	Prix
							France	Euro 1	Euro 2	Euro 3	Euro 4		
Lot de 2 sangles à bagage 1,80m à boucle plastique	-	-	-	-	-	-	00290634	00290634	00290634	00290634	-	5	-

Sangle / DE BAGAGE ECO



GARANTIE

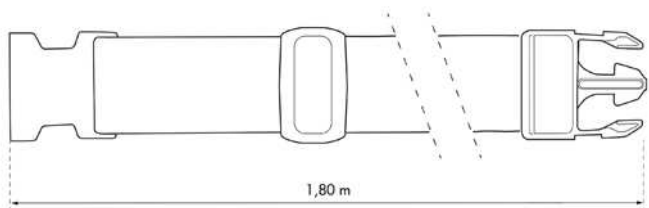

Description/Description/Descripción

Sangle polyester, boucle de serrage polyamide.
Polyester strap, plastic buckle.
Correa poliéster, hebilla de plástico

Finition/Finish/Acabado

Rouge
Red.
Rojo.

Utilisation/Use/Utilización

Maintien, sécurise et facilite l'identification votre valise.
LasMaintain, secure and facilitate identification of your luggage.
Mantener, asegurar y facilitar la identificación de su equipaje.

Designation	Boite	Colis.	Prix	Sachet	Colis.	Prix	Brochable					Colis.	Prix
							France	Euro 1	Euro 2	Euro 3	Euro 4		
Lot de 2 sangles à bagage 1,80m à boucle clip fermeture rapide	-	-	-	-	-	-	00290633	00290633	00290633	00290633	-	5	-

Ⓝ Non stocké/Non-stored/Producto no estocado - ☑ Sur stock Europe Zone 1 et Zone 2, nous consulter pour délai d'approvisionnement - ☒ Epuisement/Stock depletion/Agotamiento del stock

Sangle / A BOUCLE ECO



GARANTIE

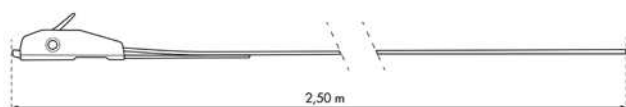

	290601	290602	290603	290604
Larg. (mm)	25	25	25	25
Long. (M)	2,50	2,50	5,00	5,00
Capacité Arrimage (DaN)	245	245	362	362
Norme	EN12195-2:2000			

Description/Description/Descripción

Sangle polyester, boucle à came 30mm zamak à dents multiples.

Polyester strap, 30mm alloy buckle.

Correa de poliéster, hebilla de aleación 30mm

Finition/Finish/Acabado

Rouge

Red.

Rojo.

Utilisation/Use/Utilización

Sangle d'arrimage pour sécuriser et fixer matériels de travail et marchandises sur remorque, coffre de toit.

Lashing strap for securing goods on trailer, roof box.

Correa de amarre para asegurar las mercancías en el remolque, caja de techo.

Designation	Boite	Colis.	Prix	Sachet	Colis.	Prix	Brochable					Colis.	Prix
							France	Euro 1	Euro 2	Euro 3	Euro 4		
Sangle à boucle autoserrante largeur 25mm x 2,50m	-	-	-	-	-	-	00290601	00290601	00290601	00290601	-	5	-
Set de 2 sangles à boucle autoserrante largeur 25mm x 2,50m	-	-	-	-	-	-	00290602	00290602	00290602	00290602	-	5	-
Sangle à boucle autoserrante largeur 25mm x 5,00m	-	-	-	-	-	-	00290603	00290603	00290603	00290603	-	5	-
Set de 2 sangles à boucle autoserrante largeur 25mm x 5,00m	-	-	-	-	-	-	00290604	00290604	00290604	00290604	-	5	-

Non stocké/Non-stored/Producto no estocado - Sur stock Europe Zone 1 et Zone 2, nous consulter pour délai d'approvisionnement - Epuement/Stock depletion/Agotamiento del stock

Sangle / A CLIQUET ECO



GARANTIE

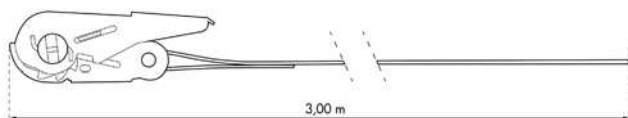

	290605	290606	290607	290608
Larg. (mm)	25	25	25	25
Long. (M)	3,00	5,00	5,00	2 x 3,00 2 x 5,00
Capacité Arrimage (DaN)	490	490	490	490
Norme	EN12195-2:2000			

Description/Description/Descripción

Sangle polyester à cliquet.
Polyester ratchet tie down.
Correa de poliéster con trinquete.

Finition/Finish/Acabado

Rouge
Red.
Rojo.

Utilisation/Use/Utilización

Sangle d'arrimage, remorque, déménagement
Trailer lashing strap.
Correa de amarre del remolque.

Designation	Boite	Colis.	Prix	Sachet	Colis.	Prix	Brochable					Colis.	Prix
							France	Euro 1	Euro 2	Euro 3	Euro 4		
Sangle à cliquet largeur 25mm x 3,00m	-	-	-	-	-	-	00290605	00290605	00290605	00290605	-	5	-
Sangle à cliquet largeur 25mm x 5,00m	-	-	-	-	-	-	00290606	00290606	00290606	00290606	-	5	-
Set de 2 sangles à cliquet largeur 25mm x 5,00m	-	-	-	-	-	-	00290607	00290607	00290607	00290607	-	5	-
Lot de 4 sangles à cliquet largeur 25mm (2x3m + 2x5m)	-	-	-	-	-	-	00290608	00290608	00290608	00290608	-	5	-

⚠ Non stocké/Non-stored/Producto no estocado - 📦 Sur stock Europe Zone 1 et Zone 2, nous consulter pour délai d'approvisionnement - 📦 Epuisement/Stock depletion/Agotamiento del stock

Sangle / A CLIQUET + CROCHET S ECO



GARANTIE

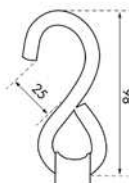
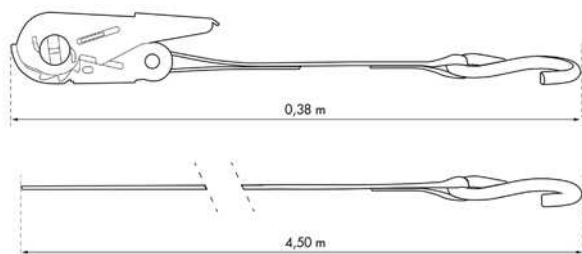

	290609	290610	290611	290612
Larg. (mm)	25	25	25	25
Long. (M)	4,50	4,50	4,50	5,00
Capacité Arrimage (DaN)	245	245	245	343
Norme	EN12195-2:2000			

Description/Description/Descripción

Sangle polyester à cliquet avec crochets S.
Sangle polyester à cliquet avec crochets S.
Polyester ratchet tie down with S hooks. Correa de poliester con trinquete, ganchos S de acero.
Sangle polyester à cliquet avec crochets S.
Polyester ratchet tie down with S hooks. Correa de poliester con trinquete, ganchos S de acero.

Finition/Finish/Acabado

290609-290610-290611 : Rouge 290612 : Jaune
290609-290610-290611 : Red 290612 : Jaune/Yellow/
Amarillo.
290609-290610-290611 : Rojo 290612 : Amarillo

Utilisation/Use/Utilización

Sangle d'arrimage pour moto, remorque, déménagement.
Lashing strap for motorcycle trailer, trailer, moving truck.
Correa de amarre del remolque de moto, remolque, movimiento.

Designation	Boite	Colis.	Prix	Sachet	Colis.	Prix	Brochable					Colis.	Prix
							France	Euro 1	Euro 2	Euro 3	Euro 4		
Sangle à cliquet 25mm x 4,50m crochet S - rouge	-	-	-	-	-	-	00290609	00290609	00290609	00290609	-	5	-
Set de 2 sangles à cliquet 25mm x 4,50m crochet S - rouge	-	-	-	-	-	-	00290610	00290610	00290610	00290610	-	5	-
Set de 4 sangles à cliquet 25mm x 4,50m crochet S - rouge	-	-	-	-	-	-	00290611	00290611	00290611	00290611	-	5	-
Set de 2 sangles à cliquet 25mm x 5,00m crochet S - jaune	-	-	-	-	-	-	00290612	00290612	00290612	00290612	-	5	-

Non stocké/Non-stored/Producto no estocado - Sur stock Europe Zone 1 et Zone 2, nous consulter pour délai d'approvisionnement - Epuisement/Stock depletion/Agotamiento del stock

Sangle / A CLIQUET + CROCHET S ECO



GARANTIE

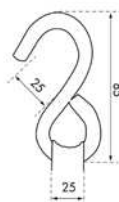
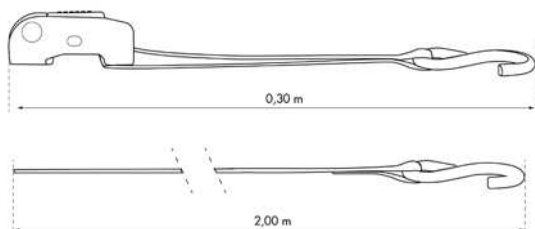

	290613
Capacité Arrimage (DaN)	245
Norme	EN12195-2:2000

Description/Description/Descripción

Sangle polyester 25mm x 2,00m à boucle autobloquante avec crochets S caoutchoutés.
Polyester ratchet tie down 25mm x 2,00m, with rubber coated S hooks.
 Correa de poliester 25mm x 2,00m con trinquete, ganchos S de acero con cubierta de PVC.

Finition/Finish/Acabado

Camouflage
Army camou
 Camu

Utilisation/Use/Utilización

Sangle d'arrimage, remorque, déménagement.
Lashing strap for trailer, moving truck.
 Correa de amarre del remolque, movimiento.

Designation	Boite	Colis.	Prix	Sachet	Colis.	Prix	Brochable					Colis.	Prix
							France	Euro 1	Euro 2	Euro 3	Euro 4		
Set de 2 sangles à cliquet 25mm x 2,00m crochet S	-	-	-	-	-	-	00290613	00290613	00290613	00290613	-	5	-

⚠ Non stocké/Non-stored/Producto no estocado - 📦 Sur stock Europe Zone 1 et Zone 2, nous consulter pour délai d'approvisionnement - ⚠ Epuisement/Stock depletion/Agotamiento del stock

Sangle / A CLIQUET + CROCHET S ECO



GARANTIE

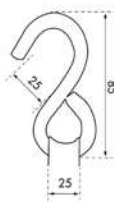
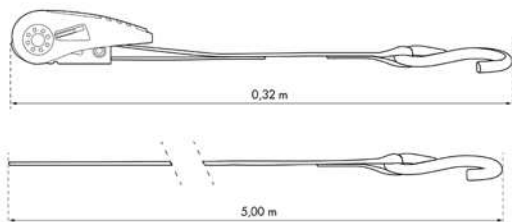

	290614
Capacité Arrimage (DaN)	490
Norme	EN12195-2:2000

Description/Description/Descripción

Sangle polyester 27mm x 5,00m à cliquet avec crochets S caoutchoutés.

Polyester ratchet tie down 27mm x 5,00m, with rubber coated S hooks.

Correa de poliéster 27mm x 5,00m con trinquete, ganchos S de acero con cubierta de PVC.

Finition/Finish/Acabado

Camouflage

Army camou

Camu

Utilisation/Use/Utilización

Sangle d'arrimage, remorque, déménagement.

Lashing strap for trailer, moving truck.

Correa de amarre del remolque, movimiento.

Designation	Boite	Colis.	Prix	Sachet	Colis.	Prix	Brochable					Colis.	Prix
							France	Euro 1	Euro 2	Euro 3	Euro 4		
Set de 2 sangles à cliquet 27mm x 5,00m crochet S	-	-	-	-	-	-	00290614	00290614	00290614	00290614	-	5	-

⚠ Non stocké/Non-stored/Producto no estocado - 📦 Sur stock Europe Zone 1 et Zone 2, nous consulter pour délai d'approvisionnement - ⚠ Epuisement/Stock depletion/Agotamiento del stock



Sangle / A CLIQUET AUTOMATIQUE ECO



GARANTIE

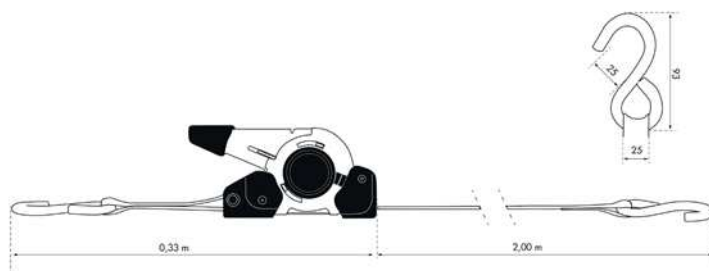
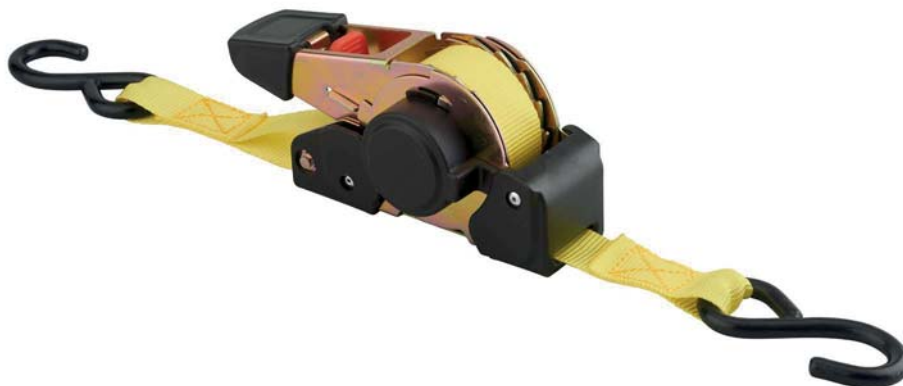

Capacité Arrimage (DaN)	290615
	313
Norme	EN12195-2:2000

Description/Description/Descripción

Sangle polyester 25mm x 3,50m à cliquet, enrouleur automatique, avec crochets S caoutchoutés.

Automatic polyester ratchet tie down 25mm x 3,50m, with rubber coated S hooks.

Correa de poliéster 25mm x 3,50m con trinquete, sistema retractil, ganchos S de acero con cubierta de PVC.

Finition/Finish/Acabado

Jaune
Yellow
Amarillo

Utilisation/Use/Utilización

Sangle d'arrimage avec système de réglage automatique.

Lashing strap with automatic adjustment system.

Correa de amarre con sistema de ajuste automático.

Designation	Boite	Colis.	Prix	Sachet	Colis.	Prix	Brochable					Colis.	Prix
							France	Euro 1	Euro 2	Euro 3	Euro 4		
Sangle à cliquet automatique 25mm x 3,50m	-	-	-	-	-	-	00290615	00290615	00290615	00290615	-	5	-

⚠ Non stocké/Non-stored/Producto no estocado - 📦 Sur stock Europe Zone 1 et Zone 2, nous consulter pour délai d'approvisionnement - ⚠ Epuisement/Stock depletion/Agotamiento del stock

Sangle / A CLIQUET + CROCHET JJ ECO



GARANTIE

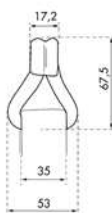
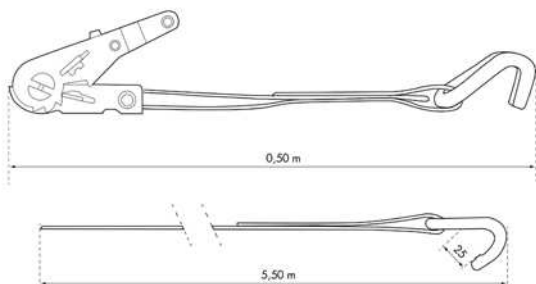

Capacité Arrimage (DaN)	290617
	1000
Norme	EN12195-2:2000

Description/Description/Descripción

Sangle polyester 35mm x 6,00m à tendeur à cliquet, avec crochets d'ancrages en JJ (crochet à griffe fermé).

Polyester ratchet tie down 35mm x 6,00m with JJ hooks.

Correa de poliéster con trinquete 35mm x 6,00m, ganchos JJ de acero.

Finition/Finish/Acabado

Bleu
Blue
Azul

Utilisation/Use/Utilización

Système d'arrimage à sangle 2 pièces pour remorque, chantier.

2-piece webbing lashing system for trailers, construction sites.

Sistema de amarre de correas de 2 piezas para remolques, obras de construcción.

Designation	Boite	Colis.	Prix	Sachet	Colis.	Prix	Brochable					Colis.	Prix
							France	Euro 1	Euro 2	Euro 3	Euro 4		
Sangle à cliquet 35mm x 6,00m à crochet JJ	-	-	-	-	-	-	00290617	00290617	00290617	00290617	-	5	-

Non stocké/Non-stored/Producto no estocado - Sur stock Europe Zone 1 et Zone 2, nous consulter pour délai d'approvisionnement - Epuement/Stock depletion/Agotamiento del stock

Sangle / A CLIQUET + CROCHET JJ ECO



GARANTIE

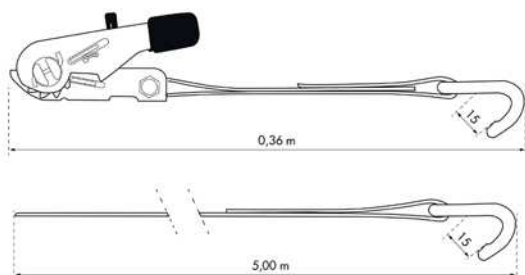

	290618
Capacité Arrimage (DaN)	735
Norme	EN12195-2:2000

Description/Description/Descripción

Sangle polyester à tendeur à cliquet, poignée ergonomique PVC, avec crochets d'ancrages en JJ (crochet à griffe fermé).

Polyester ratchet tie down with JJ hooks.

Handle with rubber moulded grip.

Correa de poliester con trinquete, ganchos JJ de acero. Mango de PVC.

Finition/Finish/Acabado

Rouge

Red

Rojo

Utilisation/Use/Utilización

Système d'arrimage à sangle 2 pièces pour remorque, chantier.

2-piece webbing lashing system for trailers, construction sites.

Sistema de amarre de correas de 2 piezas para remolques, obras de construcción.

Designation	Boite	Colis.	Prix	Sachet	Colis.	Prix	Brochable					Colis.	Prix
							France	Euro 1	Euro 2	Euro 3	Euro 4		
Sangle à cliquet 27mm x 5,00m à crochet JJ	-	-	-	-	-	-	00290618	00290618	00290618	00290618	-	5	-

⚠ Non stocké/Non-stored/Producto no estocado - 📦 Sur stock Europe Zone 1 et Zone 2, nous consulter pour délai d'approvisionnement - 📦 Epuisement/Stock depletion/Agotamiento del stock

Sangle / A CLIQUET + CROCHET JJ ECO



GARANTIE

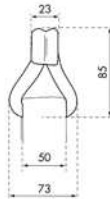
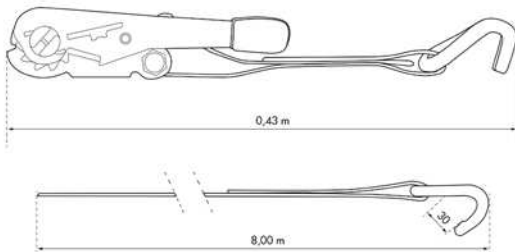
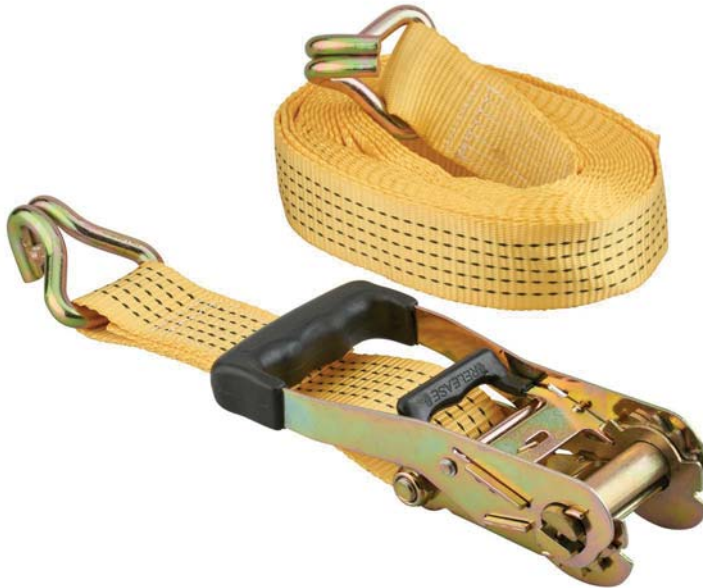

Capacité Arrimage (DaN)	290616
	2450
Norme	EN12195-2:2000

Description/Description/Descripción

Sangle polyester à tendeur à cliquet, poignée ergonomique PVC, avec crochets d'ancrages en JJ (crochet à griffe fermé).

Polyester ratchet tie down with JJ hooks.

Handle with rubber moulded grip.

Correa de poliester con trinquete, ganchos JJ de acero. Mango de PVC.

Finition/Finish/Acabado

Jaune
Yellow
Amarillo

Utilisation/Use/Utilización

Système d'arrimage à sangle 2 pièces compatible avec la plupart des moyens de transport.

Lashing strap system compatible with the mean of transport.

Sistema de amarre con correa compatible con los medios de transporte.

Designation	Boite	Colis.	Prix	Sachet	Colis.	Prix	Brochable					Colis.	Prix
							France	Euro 1	Euro 2	Euro 3	Euro 4		
Sangle à cliquet 50mm x 8,00m à crochet JJ	-	-	-	-	-	-	00290616	00290616	00290616	00290616	-	5	-

Non stocké/Non-stored/Producto no estocado - Sur stock Europe Zone 1 et Zone 2, nous consulter pour délai d'approvisionnement - Epuisement/Stock depletion/Agotamiento del stock

Sangle / A CLIQUET + CROCHET J-J ECO



GARANTIE

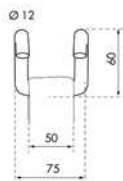
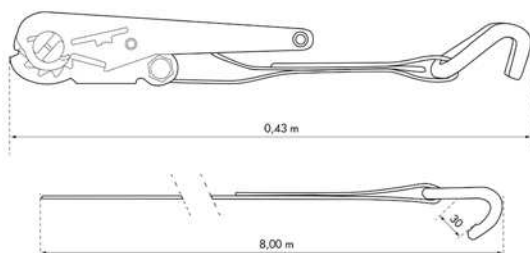

	290619
Capacité Arrimage (DaN)	2450
Norme	EN12195-2:2000

Description/Description/Descripción

Sangle polyester 50mm x 8,00m à tendeur à cliquet, avec crochets d'ancrages en J-J (crochet à griffe - bord de rive).

Polyester ratchet tie down 50mm x 8,00m with J-J hooks. Handle with rubber moulded grip.

Correa de poliester con trinquete 50mm x 8,00m, ganchos J-J de acero. Mango de PVC.

Finition/Finish/Acabado

Jaune
Yellow
Amarillo

Utilisation/Use/Utilización

Système d'arrimage à sangle 2 pièces compatible avec la plupart des moyens de transport. S'accroche sous les châssis des véhicules.

2-piece webbing lashing system compatible with most means of transport. Hangs under vehicle frames.

Sistema de amarre de correas de 2 piezas compatible con la mayoría de los medios de transporte. Se fija en la parte inferior de chasis del vehículo.

Designation	Boite	Colis.	Prix	Sachet	Colis.	Prix	Brochable				Colis.	Prix	
							France	Euro 1	Euro 2	Euro 3			Euro 4
Sangle à cliquet gainé 50mm x 8,00m à crochet J-J (bord de rive)	-	-	-	-	-	-	00290619	00290619	00290619	00290619	-	5	-

⚠ Non stocké/Non-stored/Producto no estocado - 📦 Sur stock Europe Zone 1 et Zone 2, nous consulter pour délai d'approvisionnement - 📦 Epuisement/Stock depletion/Agotamiento del stock

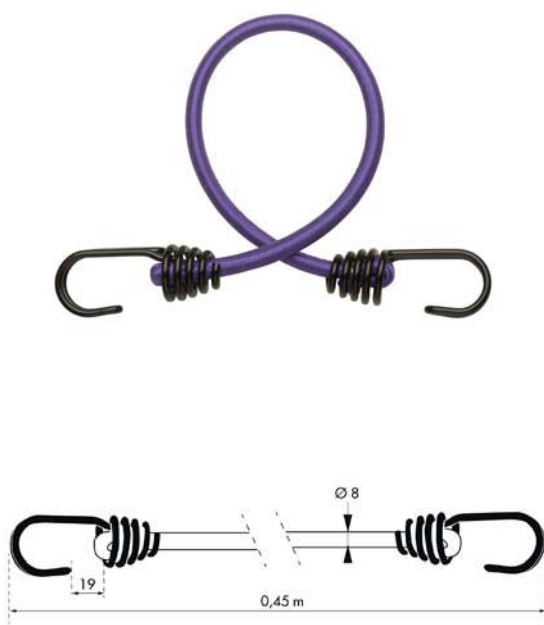

	290620	290621	290622	290623	290624
Ø	8	8	8	8	8
Long.	450	600	800	1000	1200

Description/Description/Descripción

Cordon en caoutchouc de latex, crochets acier double

Latex bungee cord, two wire steel hooks.

Tensor de latex con gancho doble de acero.

Finition/Finish/Acabado

Violet, jaune, bleu, rouge, orange

Purple, yellow, blue, red, orange

Purpura, amarillo, azul, rojo, naranja.

Utilisation/Use/Utilización

Rangement, camping, vélo, trolley, remorque

Storage, camping, bike, trailer ...

Almacenamiento, camping, bicicleta, remolque ...

Designation	Boite	Colis.	Prix	Sachet	Colis.	Prix	Brochable					Colis.	Prix
							France	Euro 1	Euro 2	Euro 3	Euro 4		
Lot de 2 sandows Ø8mm x 45cm à crochet - violet	-	-	-	-	-	-	00290620	00290620	00290620	00290620	-	10	-
Lot de 2 sandows Ø8mm x 60cm à crochet - jaune	-	-	-	-	-	-	00290621	00290621	00290621	00290621	-	10	-
Lot de 2 sandows Ø8mm x 80cm à crochet - bleu	-	-	-	-	-	-	00290622	00290622	00290622	00290622	-	10	-
Lot de 2 sandows Ø8mm x 1,00m à crochet - rouge	-	-	-	-	-	-	00290623	00290623	00290623	00290623	-	10	-
Lot de 2 sandows Ø8mm x 1,20m à crochet - orange	-	-	-	-	-	-	00290624	00290624	00290624	00290624	-	10	-



Ø	8	8	8	8
Long.	450	600	800	1000
	x 3	x 3	x 3	x 3

Description/Description/Descripción

Cordon en caoutchouc de latex, crochets acier double

Latex bungee cord, two wire steel hooks.

Tensor de latex con gancho doble de acero.

Finition/Finish/Acabado

Couleurs assorties

Assorted colors

Colores surtidos

Utilisation/Use/Utilización

Rangement, camping, vélo, trolley, remorque

Storage, camping, bike, trailer ...

Almacenamiento, camping, bicicleta, remolque ...

Designation	Boite	Colis.	Prix	Sachet	Colis.	Prix	Brochable					Colis.	Prix
							France	Euro 1	Euro 2	Euro 3	Euro 4		
Tube de 12 sandows Ø8mm longueurs variées	-	-	-	-	-	-	00290626	00290626	00290626	00290626	-	5	-

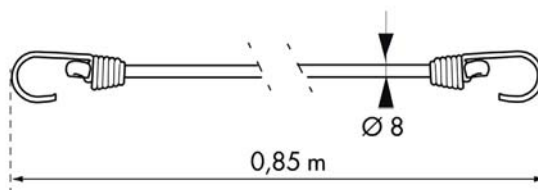

Description/Description/Descripción

Cordon en caoutchouc de latex, crochets acier simple Avec anneau central.

Latex bungee cord, one wire steel hooks. With central ring.

Tensor de latex con gancho simple de acero. Con anillo central.

Finition/Finish/Acabado

Bleu
Blue
Azul

Utilisation/Use/Utilización

Multiplés points d'attaches, idéal pour maintenir une charge sur un vélo, une moto, un quad.

Multiple points of attachment, ideal to maintain a load on a bike, a motorcycle, a quad.

Multiplés puntos de sujecion, ideales para mantener una carga en una bicicleta, una motocicleta, quad.

Designation	Boite	Colis.	Prix	Sachet	Colis.	Prix	Brochable					Colis.	Prix
							France	Euro 1	Euro 2	Euro 3	Euro 4		
Sadow pieuvre Ø8mm x 80cm à crochet	-	-	-	-	-	-	00290631	00290631	00290631	00290631	-	10	-

⚠ Non stocké/Non-stored/Producto no estocado - 📦 Sur stock Europe Zone 1 et Zone 2, nous consulter pour délai d'approvisionnement - 📦 Epuisement/Stock depletion/Agotamiento del stock



Sadow / A CROCHET ECO



GARANTIE



Ø	4	8	8	8	8
Long.	250	450	600	800	1000
	x 2	x 2	x 2	x 2	x 2

Description/Description/Descripción

Cordon en caoutchouc de latex plat, crochets plastique.

Latex bungee cord, plastic hooks.

Tensor de latex con ganchos de plastico.

Finition/Finish/Acabado

Couleurs assorties

Assorted colors

Colores surtidos

Utilisation/Use/Utilización

Rangement, camping, vélo, trolley, remorque

Storage, camping, bike, trailer ...

Almacenamiento, camping, bicicleta, remolque ...

Designation	Boite	Colis.	Prix	Sachet	Colis.	Prix	Brochable					Colis.	Prix
							France	Euro 1	Euro 2	Euro 3	Euro 4		
Set de 10 sandows longueurs variées	-	-	-	-	-	-	00290637	-	-	-	-	5	-

⚠ Non stocké/Non-stored/Producto no estocado - 📦 Sur stock Europe Zone 1 et Zone 2, nous consulter pour délai d'approvisionnement - ⚠ Epuisement/Stock depletion/Agotamiento del stock

Sandow / A CROCHET ECO



GARANTIE

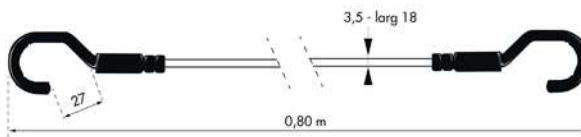

Description/Description/Descripción

Cordon en caoutchouc de latex plat, crochets plastique.

Flat latex bungee cord, plastic hooks.

Tensor plano de latex con ganchos de plastico.

Finition/Finish/Acabado

Bleu / Blue / Azul

Utilisation/Use/Utilización

Arrimage plat pour sécuriser les charges sans les endommager. Remorque, vélo, trolley ...

Flat bungee to secure the loads without damaging them.

Trailer, bike, trolley ...

Tensor plano para asegurar cargas sin danarlos. Remolque, bicicleta ...

Designation	Boite	Colis.	Prix	Sachet	Colis.	Prix	Brochable					Colis.	Prix
							France	Euro 1	Euro 2	Euro 3	Euro 4		
Sandow plat 18mm x 80cm à crochet	-	-	-	-	-	-	00290627	00290627	00290627	00290627	-	10	-

Sandow / A CROCHET ECO



GARANTIE

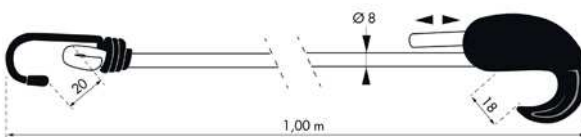

Description/Description/Descripción

Cordon en caoutchouc de latex, crochet acier simple et crochet plastique. Ajustable.

Latex bungee cord, single wire steel hook and plastic hook. Adjustable

Tensor de latex con solo gancho de acero y gancho de plastico. Ajustable

Finition/Finish/Acabado

Rouge / Red / Rojo

Utilisation/Use/Utilización

Fixation ajustable de bâche, accessoires de vélo, activités de pleins airs.

Adjustable fixing for tarpaulin, bike accessory ...

Accesorio de lona ajustable, accesorio de bicicleta...

Designation	Boite	Colis.	Prix	Sachet	Colis.	Prix	Brochable					Colis.	Prix
							France	Euro 1	Euro 2	Euro 3	Euro 4		
Sandow ajustable Ø8mm x 1,00m à crochet	-	-	-	-	-	-	00290628	00290628	00290628	00290628	-	10	-

⚠ Non stocké/Non-stored/Producto no estocado - 📦 Sur stock Europe Zone 1 et Zone 2, nous consulter pour délai d'approvisionnement - ⚠ Epuïsement/Stock depletion/Agotamiento del stock

Sadow / A CROCHET ECO



GARANTIE

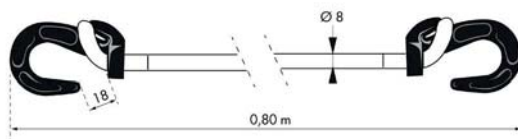

Description/Description/Descripción

Cordon en caoutchouc de latex plat, crochets plastique. Ajustable.

Latex bungee cord, plastic hooks. Adjustable.

Tensor de latex con ganchos de plastico.

Ajustable.

Finition/Finish/Acabado

Vert / Green / Verde

Utilisation/Use/Utilización

Arrimage ajustable de bagages, vélo, trolley...

Adjustable bungee for luggage, bike, accessory ...

Tensor ajustable de equipaje, accesorio de bicicleta...

Designation	Boite	Colis.	Prix	Sachet	Colis.	Prix	Brochable					Colis.	Prix
							France	Euro 1	Euro 2	Euro 3	Euro 4		
Sadow Ø8mm x 80cm à crochet+anneau	-	-	-	-	-	-	00290629	00290629	00290629	00290629	-	10	-

Sadow / A CROCHET ECO



GARANTIE

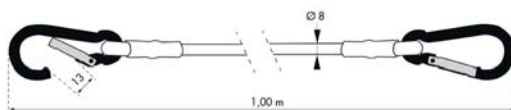

Description/Description/Descripción

Cordon en caoutchouc de latex, mousquetons aluminium.

Latex bungee cord, aluminium hooks.

Tensor de latex con ganchos de aluminio.

Finition/Finish/Acabado

Bleu / Blue / Azul

Utilisation/Use/Utilización

Fixation ajustable de bâche, accessoires de vélo, activités de pleins airs.

Adjustable fixing for tarpaulin, bike accessory ...

Accesorio de lona ajustable, accesorio de bicicleta...

Designation	Boite	Colis.	Prix	Sachet	Colis.	Prix	Brochable					Colis.	Prix
							France	Euro 1	Euro 2	Euro 3	Euro 4		
Sadow Ø8mm x 80cm à mousqueton	-	-	-	-	-	-	00290630	00290630	00290630	00290630	-	10	-

⚠ Non stocké/Non-stored/Producto no estocado - ☑ Sur stock Europe Zone 1 et Zone 2, nous consulter pour délai d'approvisionnement - ☒ Epuisement/Stock depletion/Agotamiento del stock

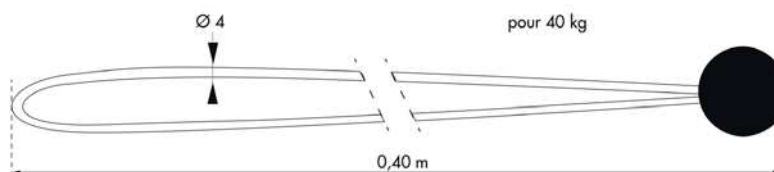

Description/Description/Descripción

Cordon en caoutchouc de latex, boule de blocage ABS.

Ball bungee cord.

Tensor elastico con bola de plastico

Finition/Finish/Acabado

Rouge

Red

Rojo

Utilisation/Use/Utilización

Fixation rapide élastique avec boule de blocage pour bâches, auvents, stores, idéal et polyvalent.

Fast elastic fastening with ball.

Cierre elastico rapido con bola de bloqueo.

Designation	Boite	Colis.	Prix	Sachet	Colis.	Prix	Brochable					Colis.	Prix
							France	Euro 1	Euro 2	Euro 3	Euro 4		
Lot de 4 tendeurs Ø4mm x 40cm à boule	-	-	-	-	-	-	00290632	00290632	00290632	00290632	-	10	-



Anneau / ARRIMAGE ECO



GARANTIE

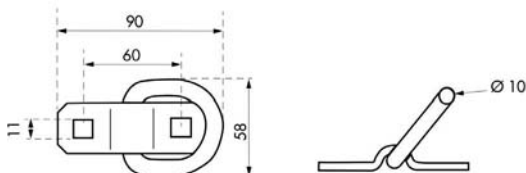
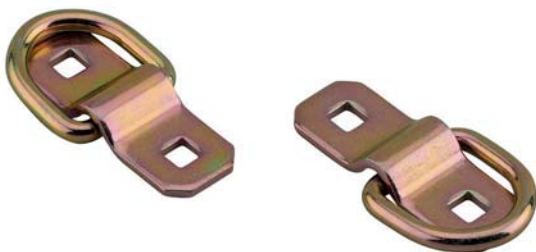

Description/Description/Descripción

Platine et anneau acier zingué. Charge de rupture : 2270kg.

Zinc coated steel plate and ring . Break strength : 2270kg.

Pletina y anillo de acero cincado Fuerza de ruptura : 2270kg.

Finition/Finish/Acabado

Zingué

Zinc plated

Cincado

Utilisation/Use/Utilización

Anneau d'arrimage pour remorque, à boulonner sur ridelles, châssis ou plancher.

D ring tie down anchor for trailer

Anillo de remolque

Designation	Boite	Colis.	Prix	Sachet	Colis.	Prix	Brochable					Colis.	Prix
							France	Euro 1	Euro 2	Euro 3	Euro 4		
Lot de 2 anneaux d'arrimage Ø10mm	-	-	-	-	-	-	00290635	00293035	-	00294035	-	10	-

Anneau / ARRIMAGE ECO



GARANTIE

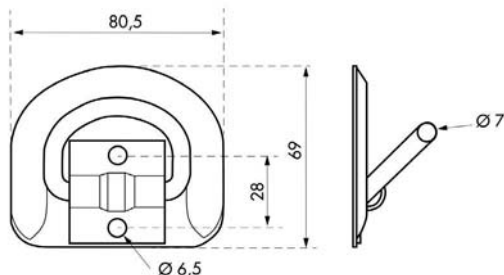

Description/Description/Descripción

Platine et anneau acier zingué. Charge de rupture : 1000kg.

Zinc coated steel plate and ring . Break strength : 1000kg.

Pletina y anillo de acero cincado Fuerza de ruptura : 1000kg.

Finition/Finish/Acabado

Zingué

Zinc plated

Cincado

Utilisation/Use/Utilización

Anneau d'arrimage pour remorque, à boulonner sur ridelles, châssis ou plancher.

D ring tie down anchor for trailer

Anillo de remolque

Designation	Boite	Colis.	Prix	Sachet	Colis.	Prix	Brochable					Colis.	Prix
							France	Euro 1	Euro 2	Euro 3	Euro 4		
Lot de 2 anneaux d'arrimage Ø7mm	-	-	-	-	-	-	00290636	00293036	-	00294036	-	10	-





⚠ Non stocké/Non-stored/Producto no estocado - ☑ Sur stock Europe Zone 1 et Zone 2, nous consulter pour délai d'approvisionnement - ☒ Epuisement/Stock depletion/Agotamiento del stock

Notes



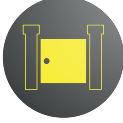

Equipements de porte

PORTE D'ENTREE		274	PORTE INTERIEURE		292
EQUIPEMENT DE FENETRE		321	EQUIPEMENT DE VOLETS		327
EQUIPEMENT DE PORTAIL		329	PROTECTION DE LA PERSONNE		331
POIGNEE DE MALE		332	FERMETURE A LEVIER		333
ACCESSOIRES DE FIXATION		336	PATERE		340
SIGNALETIQUE		343	PARKING		355























*Sommaire détaillé par produit
page suivante*



Equipements de porte







PORTE D'ENTREE































Charnières		274
Paumelles		275
Paumelles de Paris		276
Paumelles à souder		277
Gond RAPIDO		279
Protège-gonds		280
Crochet		281
Entrebâilleur à chaînette		283
Entrebâilleur à chaînette		283
Entrebâilleur à chaînette		284
Entrebâilleur verrou à chaînette		284
Entrebâilleur		285
Entrebâilleur		286
Entrebâilleur		287
Judas 180°		288
Judas 160°		288
Judas avec plaque d'identité		289
Judas 200°		289
Judas vidéo		290
Judas vidéo Digitalvisia		291

PORTE INTERIEURE



Ferme-porte		292
Ferme-porte à ressort		292
Ferme-porte		293
Ferme-porte		294
Ferme-porte		295
Ferme-porte hydraulique		296

Ferme-porte Force 3 et 4		297
Ferme-porte Force 5		298
Ferme porte à came		299
Ferme porte DESIGN		300
Câle de porte		302
Câle de porte		303
Arrêt de porte		304
Arrêt de porte		304
Arrêt de porte		305
Verrou baïonnette		305
Verrou à plaquer		306
Verrou vertical		307
Verrou à plaquer		308
Verrou vertical		309
Loqueteau Alsacien		310
Verrou à onglet		311
Butoir de porte		312
Butoir de porte		313
Butoir de porte		314
Butoir de porte		314
Butoir de porte		315
Butoir de porte		316
Butoir de porte		316
Butoir de porte		317
Butoir de porte		318
Butoir de porte		319
Butoir de porte		320
Butoir de porte		320

EQUIPEMENT DE FENETRE



Entrebâilleur de fenêtre		321
Entrebâilleur de fenêtre		321
Entrebâilleur de fenêtre		322
Entrebâilleur de fenêtre		322
Entrebâilleur de fenêtre		323
Entrebâilleur de fenêtre		324
Entrebâilleur de fenêtre		325
Entrebâilleur de fenêtre à clé		325
Entrebâilleur de fenêtre à clé		326

EQUIPEMENT DE VOLETS



Ferme volet roulant		327
Barres de volets		328
Barres de volets cadénassables		328
Double barres de sécurité		329

EQUIPEMENT DE PORTAIL



Sabot de portail		329
Arrêt de portail		330
Arrêt de portail		330

PROTECTION DE LA PERSONNE

Amortisseur / cache prise / bloque porte / bloque tiroir / protège coin de table / entrebâilleur bloque charnière		331
---	--	-----

POIGNEE DE MALE

Poignée de malle		332
Poignée de malle avec ressort		332

FERMETURE A LEVIER

Sauterelle à levier		333
Fermeture à levier		334
Fermeture à levier		335

ACCESSOIRES DE FIXATION

Patte d'assemblage		336
Equerre de fenêtre		337
Equerre de chaise		338
Equerre de renfort		339

PATERE

Patère inox		340
Patère inox		340
Patère inox		341
Patère inox double crochet		341
Patère inox simple crochet		342
Patère inox double crochet		342

SIGNALÉTIQUE

Plaque signalétique		343
Chiffre à visser		345
Chiffre adhésif		349
Lettre adhésif		348
Disque signalétique		350
Plaque signalétique		351
Cendrier mural		354

PARKING

Miroir		355
Barrière		355
Chaîne		356
Maillons		356

Equipement de porte / CHARNIERES

ECO



GARANTIE

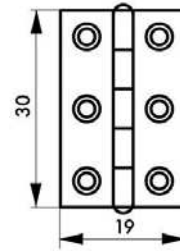

Acier



Acier décapé

Ø	4	8	8	8	8
Long.	250	450	600	800	1000
	x 2	x 2	x 2	x 2	x 2

Description/Description/Descripción
 Simple feuille acier décapé. Nœud roulé.
Simple scaling steel sheet. Rolled knot.
 Simple hoja acero decapado. Nódulo enrollado.

Finition/Finish/Acabado
 Acier décapé
Steel
 decapado

Version/Option/Versión
 Tout laiton
Solid brass
 Totalmente de latón
Utilisation/Use/Utilización
 Ameublement. Portes légères.
Furnishing. Light doors.
 Mobiliario. Puertas ligeras.

Designation	Boite	Colis.	Prix	Sachet	Colis.	Prix	Brochable					Colis.	Prix
							France	Euro 1	Euro 2	Euro 3	Euro 4		
CHARNIERE acier 30 x 19 mm	00030190	10	-	-	-	-	-	-	-	-	-	-	-
CHARNIERE acier 40 x 25 mm	00040250	10	-	-	-	-	-	-	-	-	-	-	-
CHARNIERE acier 50 x 30 mm	00050300	10	-	-	-	-	-	-	-	-	-	-	-
CHARNIERE acier 60 x 35 mm	00060350	10	-	-	-	-	-	-	-	-	-	-	-
CHARNIERE acier 70 x 40 mm	00070400	10	-	-	-	-	-	-	-	-	-	-	-
CHARNIERE laiton 30 x 19 mm	00030319	10	-	-	-	-	-	-	-	-	-	-	-
CHARNIERE laiton 40 x 25 mm	00040325	10	-	-	-	-	-	-	-	-	-	-	-
CHARNIERE laiton 50 x 30 mm	00050330	10	-	-	-	-	-	-	-	-	-	-	-
CHARNIERE laiton 60 x 35 mm	00060335	10	-	-	-	-	-	-	-	-	-	-	-
CHARNIERE laiton 70 x 40 mm	00070340	10	-	-	-	-	-	-	-	-	-	-	-
CHARNIERE inox inox 304 - 40 x 25 mm	00041250	10	-	-	-	-	-	-	-	-	-	-	-
CHARNIERE inox inox 304 - 50 x 30 mm	00051300	10	-	-	-	-	-	-	-	-	-	-	-
CHARNIERE inox inox 304 - 60 x 35 mm	00061350	10	-	-	-	-	-	-	-	-	-	-	-
CHARNIERE inox inox 304 - 70 x 40 mm	00071400	10	-	-	-	-	-	-	-	-	-	-	-

⚠ Non stocké/Non-stored/Producto no estocado - ☑ Sur stock Europe Zone 1 et Zone 2, nous consulter pour délai d'approvisionnement - ☒ Epuisement/Stock depletion/Agotamiento del stock

Equipement de porte / PAUMELLES

ECO



GARANTIE

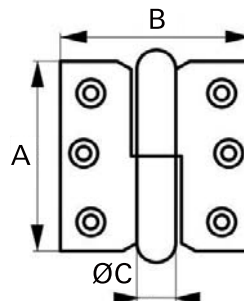

Acier



Nickelé

	30x40	40x50	50x40	60x40
A	30	40	50	60
B	40	50	40	40
ØC	7	7	7	7

Description/Description/Descripción

Acier

Steel

Acero

Finition/Finish/Acabado

Nickelé

Nickel plated

Niquelado

Version/Option/Versión

Droite et gauche

Right or left

Derecha e izquierda

Utilisation/Use/Utilización

Ameublement. Portes légères.

Furnishing. Light doors.

Mobiliario. Puertas ligeras.

Designation	Boite	Colis.	Prix	Sachet	Colis.	Prix	Brochable					Colis.	Prix
							France	Euro 1	Euro 2	Euro 3	Euro 4		
PAUMELLE • 30 x 40 mm droite	00013040	25	-	-	-	-	-	-	-	-	-	-	-
PAUMELLE • 30 x 40 mm gauche	00013041	25	-	-	-	-	-	-	-	-	-	-	-
PAUMELLE • 40 x 50 mm droite	00014050	25	-	-	-	-	-	-	-	-	-	-	-
PAUMELLE • 40 x 50 mm gauche	00014051	25	-	-	-	-	-	-	-	-	-	-	-
PAUMELLE • 50 x 40 mm droite	00015040	25	-	-	-	-	-	-	-	-	-	-	-
PAUMELLE • 50 x 40 mm gauche	00015041	25	-	-	-	-	-	-	-	-	-	-	-
PAUMELLE • 60 x 40 mm droite	00016040	25	-	-	-	-	-	-	-	-	-	-	-
PAUMELLE • 60 x 40 mm gauche	00016041	25	-	-	-	-	-	-	-	-	-	-	-

☒ Non stocké/Non-stored/Producto no estocado - ☑ Sur stock Europe Zone 1 et Zone 2, nous consulter pour délai d'approvisionnement - ☒ Epuement/Stock depletion/Agotamiento del stock

Equipement de porte / PAUMELLES DE PARIS

ECO



GARANTIE

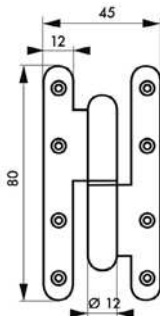

Acier



zingué



Description/Description/Descripción

Acier. Bouts ronds. Bague laiton.

Steel. Round ended. Brass ferrule.

Acero. Extremos redondos. Anillo de latón.

Finition/Finish/Acabado

Zingué

Zinc plated

Cincado

Version/Option/Versión

Inox. Droite et gauche. Bouts carrés sur demande.

Stainless steel. Right or left. Square ended on request.

Acero inoxidable. Derecha e izquierda. Extremos cuadrados por encargo.

Utilisation/Use/Utilización

Porte d'entrée, d'intérieur.

Entrance doors. Inside doors.

Puerta de entrada, de interior.

Designation	Boite	Colis.	Prix	Sachet	Colis.	Prix	Brochable					Colis.	Prix
							France	Euro 1	Euro 2	Euro 3	Euro 4		
PAUMELLE de Paris 80 x 45 mm droite	00060041	10	-	-	-	-	-	-	-	-	-	-	-
PAUMELLE de Paris 80 x 45 mm gauche	00060141	10	-	-	-	-	-	-	-	-	-	-	-
PAUMELLE de Paris 110 x 55 mm droite	00060042	10	-	-	-	-	-	-	-	-	-	-	-
PAUMELLE de Paris 110 x 55 mm gauche	00060142	10	-	-	-	-	-	-	-	-	-	-	-
PAUMELLE de Paris 140 x 55 mm droite	00060043	10	-	-	-	-	-	-	-	-	-	-	-
PAUMELLE de Paris 140 x 55 mm gauche	00060143	10	-	-	-	-	-	-	-	-	-	-	-
Paumelle de Paris inox 110x55x2.5mm droite	00061043	10	-	-	-	-	-	-	-	-	-	-	-
Paumelle de Paris inox 110x55x2.5mm gauche	00061143	10	-	-	-	-	-	-	-	-	-	-	-
Paumelle de Paris inox 140x55x2.5mm droite	00061044	10	-	-	-	-	-	-	-	-	-	-	-
Paumelle de Paris inox 140x55x2.5mm gauche	00061144	10	-	-	-	-	-	-	-	-	-	-	-

⚠ Non stocké/Non-stored/Producto no estocado - ☑ Sur stock Europe Zone 1 et Zone 2, nous consulter pour délai d'approvisionnement - ☒ Epuisement/Stock depletion/Agotamiento del stock

Equipement de porte / PAUMELLES À SOUDER

ECO



GARANTIE

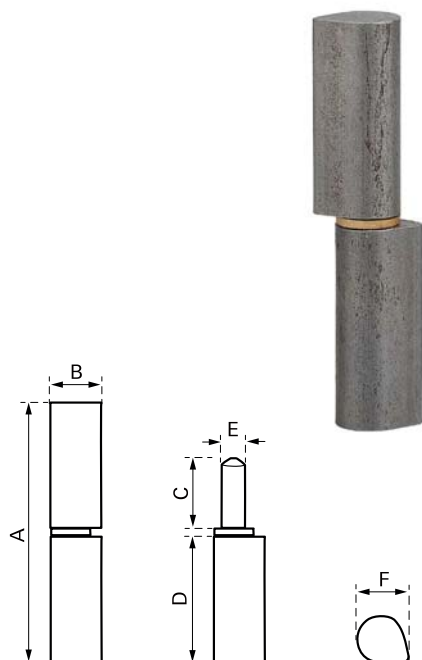

	60x10	80x13	100x16	120x20	140x20	160x20
A	60	80	100	120	140	160
B	10	13	16	20	20	20
C	13,50	18	28	28	28	31
D	29,25	39,25	48,75	58,50	68,50	78,50
E	6	7	9	11	11	11
F	13	16	20	25	25	25

Description/Description/Descripción

Acier. Bague laiton.
Steel. Brass washer.
Acero. Anillo de latón.

Finition/Finish/Acabado

Acier.
Steel.
Acero.

Utilisation/Use/Utilización

Porte d'entrée, d'intérieur.
Entrance doors. Inside doors.
Puerta de entrada, de interior.

Designation	Boite	Colis.	Prix	Sachet	Colis.	Prix	Brochable					Colis.	Prix
							France	Euro 1	Euro 2	Euro 3	Euro 4		
Paumelle à souder H.60mm bague laiton	00060044	10	-	-	-	-	-	-	-	-	-	-	-
Paumelle à souder H.80mm bague laiton	00060045	10	-	-	-	-	-	-	-	-	-	-	-
Paumelle à souder H.100mm bague laiton	00060046	10	-	-	-	-	-	-	-	-	-	-	-
Paumelle à souder H.120mm bague laiton	00060047	10	-	-	-	-	-	-	-	-	-	-	-
Paumelle à souder H.140mm bague laiton	00060048	10	-	-	-	-	-	-	-	-	-	-	-
Paumelle à souder H.160mm bague laiton	00060049	10	-	-	-	-	-	-	-	-	-	-	-
Paumelle à souder inox 10x13x60mm	00060054	10	-	-	-	-	-	-	-	-	-	-	-
Paumelle à souder inox 13x16x80mm	00060055	10	-	-	-	-	-	-	-	-	-	-	-
Paumelle à souder inox 16x20x100mm	00060056	10	-	-	-	-	-	-	-	-	-	-	-
Paumelle à souder inox 20x25x120mm	00060057	10	-	-	-	-	-	-	-	-	-	-	-
Paumelle à souder inox 20x25x140mm	00060058	10	-	-	-	-	-	-	-	-	-	-	-
Paumelle à souder inox 20x25x160mm	00060059	10	-	-	-	-	-	-	-	-	-	-	-

Non stocké/Non-stored/Producto no estocado - Sur stock Europe Zone 1 et Zone 2, nous consulter pour délai d'approvisionnement - E Epuement/Stock depletion/Agotamiento del stock

Equipement de porte / PAUMELLES À SOUDER

ECO

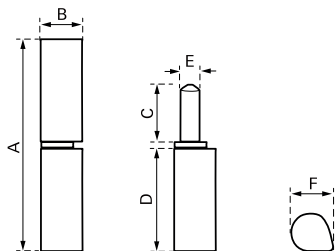

	060144	060145	060146
A	120	140	160
B	20	20	20
C	24	24	27
D	56,50	66,50	76,50
E	11	11	11
F	25	25	25



GARANTIE

Description/Description/Descripción

Acier. Roulement à billes.

Steel. Balls bearing.

Rodamiento de bolas.

Finition/Finish/Acabado

Acier.

Steel.

Acero.

Utilisation/Use/Utilización

Porte d'entrée, d'intérieur.

Entrance doors. Inside doors.

Puerta de entrada, de interior.

Designation	Boite	Colis.	Prix	Sachet	Colis.	Prix	Brochable					Colis.	Prix
							France	Euro 1	Euro 2	Euro 3	Euro 4		
Paumelle à souder H.120mm butée à billes	00060144	10	-	-	-	-	-	-	-	-	-	-	-
Paumelle à souder H.140mm butée à billes	00060145	10	-	-	-	-	-	-	-	-	-	-	-
Paumelle à souder H.160mm butée à billes	00060146	10	-	-	-	-	-	-	-	-	-	-	-

Equipement de porte / PAUMELLES À SOUDER

ECO

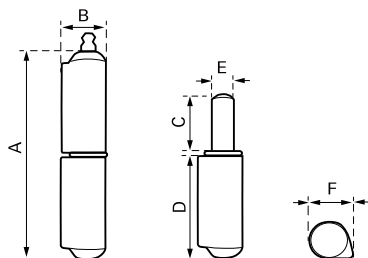

	060147	060148	060149
A	100	120	140
B	16	16	20
C	28	28	28
D	48,75	58,75	68,50
E	9	9	11
F	20	20	25



GARANTIE

Description/Description/Descripción

Acier. Bague laiton. Avec graisseur.

Steel. Brass washer. With grease nipple.

Acero. Anillo de latón. Con engrasador.

Finition/Finish/Acabado

Acier.

Steel.

Acero.

Utilisation/Use/Utilización

Porte d'entrée, d'intérieur.

Entrance doors. Inside doors.

Puerta de entrada, de interior.

Designation	Boite	Colis.	Prix	Sachet	Colis.	Prix	Brochable					Colis.	Prix
							France	Euro 1	Euro 2	Euro 3	Euro 4		
Paumelle à souder H.120mm butée à billes	00060147	10	-	-	-	-	-	-	-	-	-	-	-
Paumelle à souder H.140mm butée à billes	00060148	10	-	-	-	-	-	-	-	-	-	-	-
Paumelle à souder H.160mm butée à billes	00060149	10	-	-	-	-	-	-	-	-	-	-	-

⚠ Non stocké/Non-stored/Producto no estocado - 📦 Sur stock Europe Zone 1 et Zone 2, nous consulter pour délai d'approvisionnement - 📦 Epuisement/Stock depletion/Agotamiento del stock

Equipement de porte / GOND RAPIDO

PROTECT



GARANTIE



MODÈLE
BREVETÉ
PROTÉGÉ

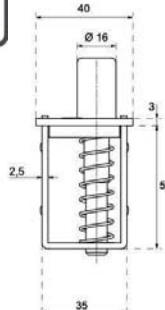
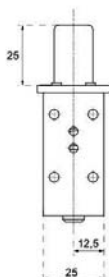

Gond à dé clic rapide,
partie supérieure

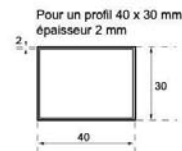

Pour un profil 40 x 30 mm
épaisseur 2 mm

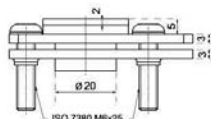

Dispositif d'ajustement du volet

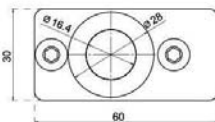

Montage rapide. Permet un déblocage rapide du vantail avec un verrouillage de sécurité réglable pour éviter tout glissement.

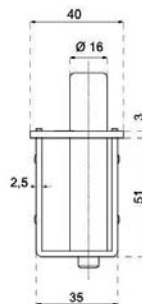
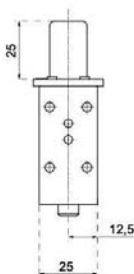

Gond à dé clic rapide,
partie inférieure

Description/Description/Descripción

Goupille en acier de Ø 16mm. Zingage noir hautement résistant à la corrosion. Assemblage sans soudure. Dispositif de réglage du vantail Rondelle anti-friction inférieure. Gâche en acier inoxydable.
16mm steel pin. Black zinc plating highly resistant to corrosion. Seamless assembly. Leaf adjustment device Lower anti-friction washer. Stainless steel strike plate.
Pasador de acero Ø 16mm. Cincado negro altamente resistente a la corrosión. Montaje sin fi suras. Dispositivo de ajuste de la hoja Arandela inferior antifricción. Placa de cierre de acero inoxidable.

Finition/Finish/Acabado

Résistant à la corrosion.
Corrosion-resistant.

Resistente a la corrosión

Utilisation/Use/Utilización

Idéal pour les grilles et portails de sécurité.
Ideal for security gates and doors.
Ideal para puertas y portales de seguridad.

Designation	Boite	Colis.	Prix	Sachet	Colis.	Prix	Brochable					Colis.	Prix
							France	Euro 1	Euro 2	Euro 3	Euro 4		
Gond rapido	-	-	-	00912259	1	-	-	-	-	-	-	-	-

Non stocké/Non-stored/Producto no estocado - Sur stock Europe Zone 1 et Zone 2, nous consulter pour délai d'approvisionnement - Epuisement/Stock depletion/Agotamiento del stock

Equipement de porte / PROTEGE-GONDS

PROTECT



GARANTIE

Système de protege-gonds pour consolider fermement les portes d'entrée.

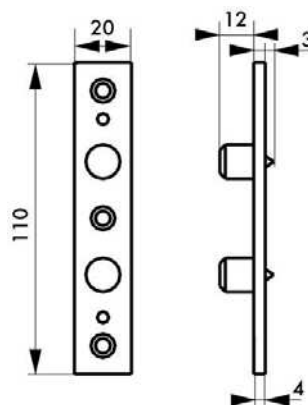

Description/Description/Descripción

Acier comprenant une partie mâle et une partie femelle
 Steel, each set consists of a male part and a female part.
 Acero que consta una parte macho y otra hembra.

Finition/Finish/Acabado

Zingué
 Zinc plated
 Cincado

Utilisation/Use/Utilización

Tous types de portes.
 For all types of doors.
 Todo tipo de puertas.

Designation	Boite	Colis.	Prix	Sachet	Colis.	Prix	Brochable					Colis.	Prix
							France	Euro 1	Euro 2	Euro 3	Euro 4		
Protège-gonds la paire	00025000	10	-	00925000	20	-	00225000	00293246 NS	00292246 NS	00294246	-	10	-

NS Non stocké/Non-stored/Producto no estocado - Sur stock Europe Zone 1 et Zone 2, nous consulter pour délai d'approvisionnement - E Epuisement/Stock depletion/Agotamiento del stock

Equipement de porte / CROCHET

ECO



GARANTIE

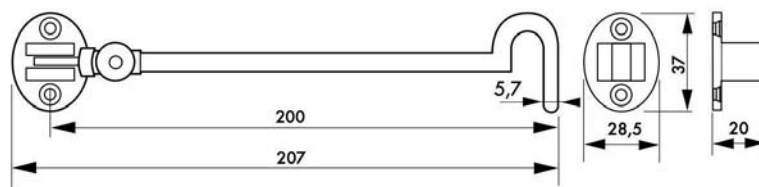
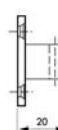
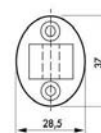
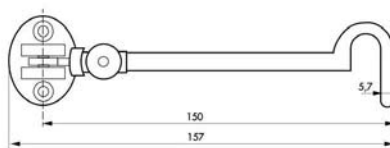
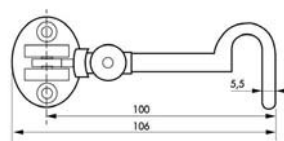

Description/Description/Descripción

Corps en alliage, orientable.

Alloy body, adjustable.

Cuerpo de aleación, orientable.

Finition/Finish/Acabado

Chromé - Laitonné

Chrome plated - Brass plated

Cromado - Latonado

Utilisation/Use/Utilización

Porte et fenêtre.

Door and window.

Puerta y ventan

Designation	Boite	Colis.	Prix	Sachet	Colis.	Prix	Brochable					Colis.	Prix
							France	Euro 1	Euro 2	Euro 3	Euro 4		
Crochet chromé 100 mm	-	-	-	00991030	10	-	00191030	00193980	00192980	00194980	-	10	-
Crochet chromé 150 mm	-	-	-	00991031	10	-	00291031	00293981	00292981	00294981	-	10	-
Crochet chromé 200 mm	-	-	-	00991032	10	-	00291032	00293982	00292982	00294982	-	10	-
Crochet laitonné 100 mm	-	-	-	00991035	10	-	00191035	00193985	00192985	00194985	-	10	-
Crochet laitonné 150 mm	-	-	-	00991036	10	-	00291036	00293986	00292986	00294986	-	10	-
Crochet laitonné 200 mm	-	-	-	00991037	10	-	00291037	00293987	00292987	00294987	-	10	-

⚠ Non stocké/Non-stored/Producto no estocado - 📦 Sur stock Europe Zone 1 et Zone 2, nous consulter pour délai d'approvisionnement - 🇪🇺 Epuisement/Stock depletion/Agotamiento del stock

Equipement de porte / CROCHET

ECO



GARANTIE

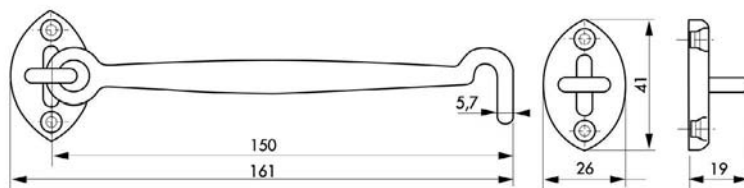
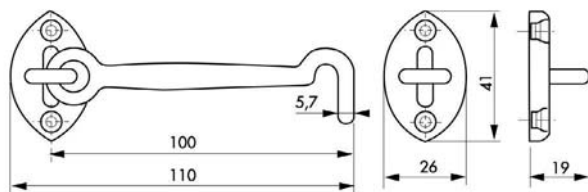

Description/Description/Descripción

Corps en alliage.

Alloy body.

Cuerpo de aleación.

Finition/Finish/Acabado

Chromé - Laitonné

Chrome plated - Brass plated

Cromado - Latonado

Utilisation/Use/Utilización

Porte et fenêtre.

Door and window.

Puerta y ventana

Designation	Boite	Colis.	Prix	Sachet	Colis.	Prix	Brochable					Colis.	Prix
							France	Euro 1	Euro 2	Euro 3	Euro 4		
Crochet chromé 100 mm	-	-	-	00991033	10	-	00191033	00193983	00192983	00194983	-	10	-
Crochet chromé 150 mm	-	-	-	00991034	10	-	00291034	00293984	00292984	00294984	-	10	-
Crochet laitonné 100 mm	-	-	-	00991038	10	-	00191038	00193988	00192988	00194988	-	10	-
Crochet laitonné 150 mm	-	-	-	00991039	10	-	00291039	00293993	00292993	00294993	-	10	-

⚠ Non stocké/Non-stored/Producto no estocado - ☑ Sur stock Europe Zone 1 et Zone 2, nous consulter pour délai d'approvisionnement - ☒ Epuisement/Stock depletion/Agotamiento del stock

Equipement de porte / ENTREBÂILLEUR ECO

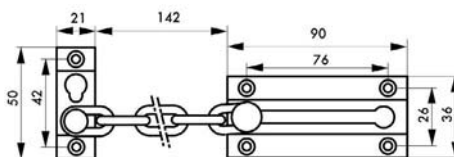

GARANTIE

Description/Description/Descripción

Support et platine acier.
Steel bearer and plate steel chain.
Soporte y pletina de acero.

Finition/Finish/Acabado

Laitonné. Nickelé.
Brass plated. Nickel plated.
Latonado. Niquelado.

Utilisation/Use/Utilización

Blocage de porte d'entrée en position entrebâillée.
Locking for entrance doors in fastened position.
Bloqueo de puerta de entrada en posición entreabierta.

Designation	Boîte	Colis.	Prix	Sachet	Colis.	Prix	Brochable					Colis.	Prix
							France	Euro 1	Euro 2	Euro 3	Euro 4		
CHAÎNE DE SECURITE ECO laitonnée	-	-	-	00900403	20	-	00200403	00293078 NS	00292078 NS	00294078	-	10	-
CHAÎNE DE SECURITE ECO laitonnée	-	-	-	-	-	-	-	-	00992078 NS	-	-	10	-
CHAÎNE DE SECURITE ECO nickelée	-	-	-	00900430	20	-	00200430	00293079 NS	00292079 NS	00294079	-	10	-

Equipement de porte / ENTREBÂILLEUR PROTECT

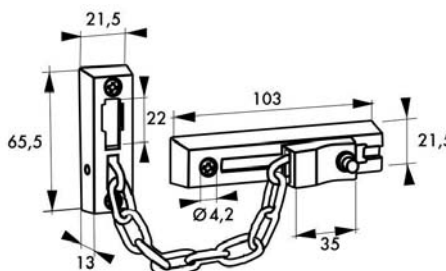

GARANTIE

Description/Description/Descripción

Corps et platine alliage. Chaîne acier.
Alloy fastener and plate. Steel chain.
Cuerpo y pletina de aleación. Cadena de acero.

Finition/Finish/Acabado

Nickel satin
Nickel satin
Níquel satinado

Utilisation/Use/Utilización

Blocage de porte d'entrée en position entrebâillée.
Locking for entrance doors in fastened position.
Bloqueo de puerta de entrada en posición entreabierta.

Designation	Boîte	Colis.	Prix	Sachet	Colis.	Prix	Brochable					Colis.	Prix
							France	Euro 1	Euro 2	Euro 3	Euro 4		
ENTREBAILLEUR DE PORTE	-	-	-	00909412	10	-	00209412	00293894 NS	00292894 NS	00294894	-	10	-

NS Non stocké/Non-stored/Producto no estocado - □ Sur stock Europe Zone 1 et Zone 2, nous consulter pour délai d'approvisionnement - E Epuisement/Stock depletion/Agotamiento del stock

Equipement de porte / ENTREBÂILLEUR PROTECT



GARANTIE

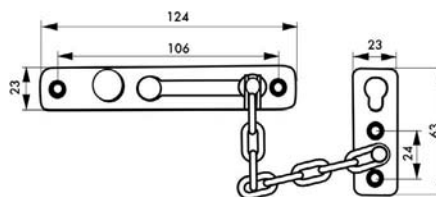

Description/Description/Descripción

Support et platine acier.

Steel bearer and plate steel chain.

Soporte y pletina de acero.

Finition/Finish/Acabado

Nickelé, doré

Nickel, gold plated

Niquelado, dorado

Utilisation/Use/Utilización

Blocage de porte d'entrée en position entrebâillée.

Locking for entrance doors in fastened position.

Bloqueo de puerta de entrada en posición entreabierta.

Designation	Boite	Colis.	Prix	Sachet	Colis.	Prix	Brochable					Colis.	Prix
							France	Euro 1	Euro 2	Euro 3	Euro 4		
CHAÎNE DE SECURITE GM nickelée	-	-	-	-	-	-	00209408	00293715 NS	00292715 NS	00294715	-	10	-
CHAÎNE DE SECURITE GM dorée	-	-	-	-	-	-	00209409	00293716 NS	00292716 NS	00294716	-	10	-

Equipement de porte / ENTREBÂILLEUR RESIST



GARANTIE

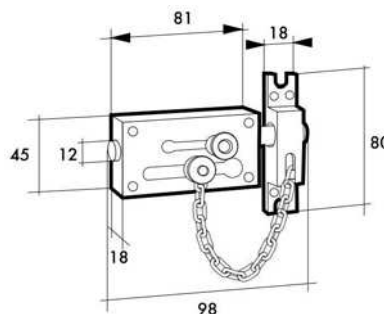

Description/Description/Descripción

Corps et platine alliage. Pêne acier. Chaîne acier.

Alloy fastener and plate. Steel bolt. Steel chain.

Cuerpo y pletina de aleación. Pestillo de acero. Cadena de acero.

Finition/Finish/Acabado

Nickel satin

Nickel satin

Níquel satinado

Utilisation/Use/Utilización

Blocage de porte d'entrée en position entrebâillée.

Locking for entrance doors in fastened position.

Bloqueo de puerta de entrada en posición entreabierta.

Designation	Boite	Colis.	Prix	Sachet	Colis.	Prix	Brochable					Colis.	Prix
							France	Euro 1	Euro 2	Euro 3	Euro 4		
VERROU ENTREBAILLEUR DE PORTE	-	-	-	00909411	10	-	00209411	00293893 NS	00292893 NS	00294893	-	10	-

NS Non stocké/Non-stored/Producto no estocado - ☐ Sur stock Europe Zone 1 et Zone 2, nous consulter pour délai d'approvisionnement - ☒ Epuisement/Stock depletion/Agotamiento del stock

Equipement de porte / ENTREBÂILLEUR ECO



GARANTIE

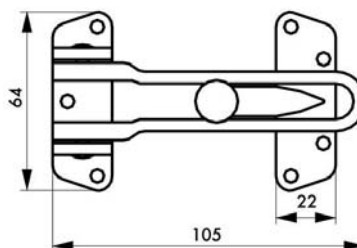

Description/Description/Descripción

Corps, platine et taquet d'arrêt alliage.

Alloy fastener, plate and catch.

Cuerpo, pletina y tope de retención de aleación.

Finition/Finish/Acabado

Nickelé, doré

Nickel, gold plated

Niquelado, dorado

Utilisation/Use/Utilización

Blocage de porte d'entrée en position entrebâillée.

Locking for entrance doors in fastened position.

Bloqueo de puerta de entrada en posición entreabierta.



Designation	Boite	Colis.	Prix	Sachet	Colis.	Prix	Brochable					Colis.	Prix
							France	Euro 1	Euro 2	Euro 3	Euro 4		
ENTREBAILLEUR DE PORTE ECO nickelé	00000304	-	-	00900304	10	-	00200304	00293081 NSI	00292081 NS	00294081	-	10	-
ENTREBAILLEUR DE PORTE ECO doré	00000305	-	-	00900305	10	-	00200305	00293080 NSI	00292080 NS	00294080	-	10	-

Equipement de porte / ENTREBÂILLEUR PROTECT



GARANTIE

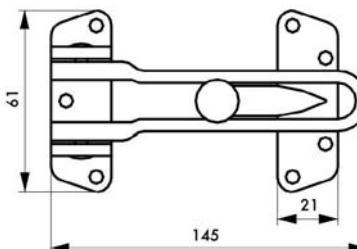

Description/Description/Descripción

Corps, platine et taquet d'arrêt alliage.

Alloy fastener, plate and catch.

Cuerpo, pletina y tope de retención de aleación.

Finition/Finish/Acabado

Nickel satin

Nickel satin

Níquel satinado

Versión/Option/Versión

Pour porte à recouvrement

For covering door frame

Para puerta que recubre el marco

Utilisation/Use/Utilización

Blocage de porte d'entrée en position entrebâillée.

Locking for entrance doors in fastened position.

Bloqueo de puerta de entrada en posición entreabierta.

Designation	Boite	Colis.	Prix	Sachet	Colis.	Prix	Brochable					Colis.	Prix
							France	Euro 1	Euro 2	Euro 3	Euro 4		
Entrebailleur de porte	-	-	-	00909402	10	-	00209402	-	00292281 NS	-	-	10	-
Entrebailleur de porte pour porte à recouvrement	-	-	-	00909403	10	-	00209403	-	00292282 NS	-	-	10	-

NS Non stocké/Non-stored/Producto no estocado - SI Sur stock Europe Zone 1 et Zone 2, nous consulter pour délai d'approvisionnement - E Epuisement/Stock depletion/Agotamiento del stock

Equipement de porte / ENTREBÂILLEUR PROTECT



GARANTIE

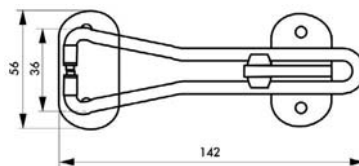

Description/Description/Descripción

Corps, platine et taquet d'arrêt acier.

Steel fastener, plate and catch.

Cuerpo, pletina y tope de retención de acero.

Finition/Finish/Acabado

Chromé, doré, blanc, inox

Chrome plated, gold plated, white, stainless steel

Cromado, dorado, blanco, acero inoxidable

Utilisation/Use/Utilización

Blocage de porte d'entrée en position entrebâillée.

Locking for entrance doors in fastened position.

Bloqueo de puerta de entrada en posición entreabierta.

Designation	Boite	Colis.	Prix	Sachet	Colis.	Prix	Brochable					Colis.	Prix
							France	Euro 1	Euro 2	Euro 3	Euro 4		
ENTREBAILLEUR DE PORTE chromé	-	-	-	00909404	10	-	00209404	00293404 NS	00292404 NS	00294404	-	10	-
ENTREBAILLEUR DE PORTE doré	-	-	-	00909405	10	-	00209405	-	-	00294203	-	10	-
ENTREBAILLEUR DE PORTE blanc	-	-	-	00909406	10	-	00209406	00293717 NS	-	00294717	-	10	-
ENTREBAILLEUR DE PORTE inox	-	-	-	00909414	10	-	-	-	-	-	-	-	-

Equipement de porte / ENTREBÂILLEUR RESIST



GARANTIE

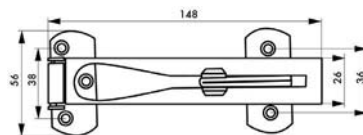

Description/Description/Descripción

Corps, platine et taquet d'arrêt acier.

Steel fastener, plate and catch.

Cuerpo, pletina y tope de retención de acero.

Finition/Finish/Acabado

Chromé, doré, inox

Chrome plated, gold plated, stainless steel

Cromado, dorado, acero inoxidable

Utilisation/Use/Utilización

Blocage de porte d'entrée en position entrebâillée.

Locking for entrance doors in fastened position.

Bloqueo de puerta de entrada en posición entreabierta.

Designation	Boite	Colis.	Prix	Sachet	Colis.	Prix	Brochable					Colis.	Prix
							France	Euro 1	Euro 2	Euro 3	Euro 4		
ENTREBAILLEUR DE PORTE chromé	-	-	-	00913904	10	-	00213904	00293718 NS	00292718 NS	00294718	-	10	-
ENTREBAILLEUR DE PORTE inox	-	-	-	00913905	10	-	00213905	00293719 NS	00292719 NS	00294719	-	10	-
ENTREBAILLEUR DE PORTE doré	-	-	-	00913906	10	-	00213906	00293720 NS	00292720 NS	00294720	-	10	-

NS Non stocké/Non-stored/Producto no estocado - E Sur stock Europe Zone 1 et Zone 2, nous consulter pour délai d'approvisionnement - E Epusement/Stock depletion/Agotamiento del stock

Equipement de porte / ENTREBÂILLEUR RESIST



GARANTIE



Avec amortisseur de bruit

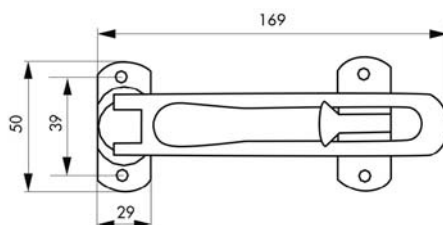

Description/Description/Descripción

Corps et platine alliage. Avec adaptateur pour porte à recouvrement. Rabattable verticalement.
Alloy fastener and plate. With adaptor for cover door. Can be folded vertically.

Cuerpo y pletina de aleación. «Con adaptador para puerta con recubrimiento. Abatible verticalmente.»

Finition/Finish/Acabado

Nickel satin, blanc
Nickel satin, white
Níquel satinado, blanco

Utilisation/Use/Utilización

Blocage de porte d'entrée en position entrebâillée.
Locking for entrance doors in fastened position.
Bloqueo de puerta de entrada en posición entreabierta.

Designation	Boite	Colis.	Prix	Sachet	Colis.	Prix	Brochable				Colis.	Prix	
							France	Euro 1	Euro 2	Euro 3			Euro 4
ENTREBAILLEUR DE PORTE blanc	-	-	-	-	-	-	00213938	-	-	-	-	10	-
ENTREBAILLEUR DE PORTE blanc	-	-	-	-	-	-	00213939	-	-	-	-	10	-

⚠ Non stocké/Non-stored/Producto no estocado - 📦 Sur stock Europe Zone 1 et Zone 2, nous consulter pour délai d'approvisionnement - ⚠ Epuement/Stock depletion/Agotamiento del stock

Equipement de porte / JUDAS ECO



GARANTIE

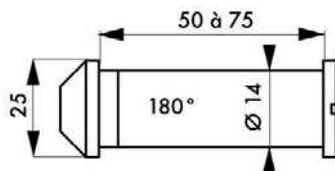

Description/Description/Descripción

Monture alliage avec volet obturateur. Système optique à 3 lentilles. Champ de vision 180°.

Alloy body with obturator shutter. Optical device with 3 lenses. Viewing angle 180°.

Montura de aleación con embellecedor obturador. Sistema óptico de 3 lentes. Campo de visión: 180°.

Finition/Finish/Acabado

Nickelé satiné.

Satin nickel.

Niquel satinado.

Utilisation/Use/Utilización

Portes légères.

Light doors.

Puertas ligeras.

Designation	Boite	Colis.	Prix	Sachet	Colis.	Prix	Brochable					Colis.	Prix
							France	Euro 1	Euro 2	Euro 3	Euro 4		
JUDAS 180° nickelé satiné	-	-	-	00992728	10	-	-	-	00192805 NS	-	-	10	-

Equipement de porte / JUDAS ECO



GARANTIE

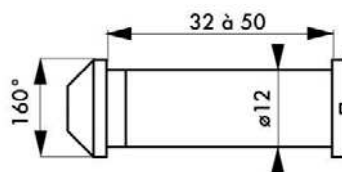

Description/Description/Descripción

Monture laiton massif avec volet obturateur. Système optique à 3 lentilles. Champ de vision 160°

Solid brass with obturator shutter. Optical device with 3 lenses. Viewing angle 160°.

Montura de latón macizo con embellecedor obturador. Sistema óptico de 3 lentes. Campo de visión: 160°.

Finition/Finish/Acabado

Laiton poli ou chromé

Polished brass or chrome plated

Latón pulido o cromado

Designation	Boite	Colis.	Prix	Sachet	Colis.	Prix	Brochable					Colis.	Prix
							France	Euro 1	Euro 2	Euro 3	Euro 4		
JUDAS 160° laiton poli	00000450	10	-	00900450	10	-	00100450	00193083 NS	00192083 NS	00194083	-	10	-
JUDAS 160° laiton chromé	00000451	10	-	00900451	10	-	00100451	00193082 NS	00192082 NS	00194082	-	10	-

NS Non stocké/Non-stored/Producto no estocado - ☐ Sur stock Europe Zone 1 et Zone 2, nous consulter pour délai d'approvisionnement - E Epusement/Stock depletion/Agotamiento del stock

Equipement de porte / JUDAS PROTECT



GARANTIE



000454



900456

Description/Description/Descripción

Monture laiton massif avec volet obturateur. Système optique à 3 lentilles. Champ de vision 170°
Solid brass with obturator shutter. Optical device with 3 lenses. Viewing angle 170°.

Montura de latón macizo con embellecedor obturador. Sistema óptico de 3 lentes. Campo de visión: 170°.

Finition/Finish/Acabado

Laiton poli ou chromé
Polished brass or chrome plated

Latón pulido o cromado

Version/Option/Versión

Avec plaque d'identité

With name plate

Con placa de identidad

Designation	Boite	Colis.	Prix	Sachet	Colis.	Prix	Brochable					Colis.	Prix
							France	Euro 1	Euro 2	Euro 3	Euro 4		
JUDAS 170° laiton poli	-	-	-	00900454	10	-	00100454	00193405	00192405 NS	-	-	10	-
JUDAS 170° laiton chromé	-	-	-	00900455	10	-	00100455	00193406	00192406 NS	-	-	10	-
JUDAS 170° avec plaque d'identité chromé	-	-	-	00900456	10	-	00100456	-	-	-	-	10	-

Equipement de porte / JUDAS RESIST



GARANTIE



000453



000457

P.V.Efectis France
N°EFR-14-003190



	000452 / 000453	000457
Ø perçage	17 mm	13 mm
A : ép. porte	35 à 58 mm	34 à 62 mm
B : Ø tête	30 mm	25 mm
angle vision	200°	160°

Description/Description/Descripción

Monture laiton massif avec volet obturateur. Système optique à 3 lentilles. Champ de vision 160°- 200°.
Solid brass with obturator shutter. Optical device with 3 lenses. Viewing angle 160° - 200°.

Montura de latón macizo con embellecedor obturador. Sistema óptico de 3 lentes. Campo de visión: 160° - 200°.

Finition/Finish/Acabado

Laiton poli ou chromé
Polished brass or chrome plated

Latón pulido o cromado

Version/Option/Versión

Coupe feu 40 minutes

40 minutes fire resistance

Cortafuegos 40 minutos

Designation	Boite	Colis.	Prix	Sachet	Colis.	Prix	Brochable					Colis.	Prix
							France	Euro 1	Euro 2	Euro 3	Euro 4		
JUDAS 160° laiton poli coupe feu 40 mn	-	-	-	00900457	10	-	00100457	-	-	-	-	10	-
JUDAS 200° laiton poli	-	-	-	00900452	10	-	00100452	00193095 NS	00192095 NS	00194095	-	10	-
JUDAS optique 200° laiton chromé	-	-	-	00900453	10	-	00100453	00193094 NS	00192094 NS	00194094	-	10	-

NS Non stocké/Non-stored/Producto no estocado - Sur stock Europe Zone 1 et Zone 2, nous consulter pour délai d'approvisionnement - E Epuisement/Stock depletion/Agotamiento del stock

Equipement de porte / JUDAS VIDEO PROTECT



GARANTIE

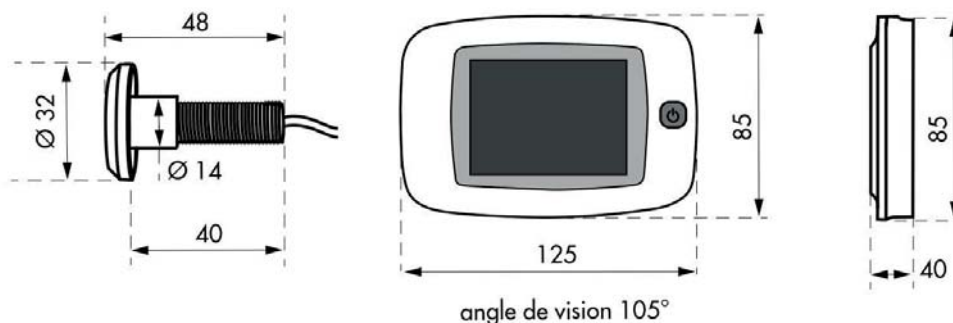

Description/Description/Descripción

Corps ABS. Caméra 0,3 méga pixels avec un angle de vision de 105°. Écran vidéo LCD intérieur (3,2»).

Alimentation par 4 piles AAA.

ABS body. Camera 0,3 mega pixels, view angle 105° - LCD screen (3,2»). 4 AAA batteries.

Cuerpo de ABS. 0,3 mega pixeles de la cámara. Campo de visión 105°. Video de lapantalla (3,2»). Desarrollado por 4 baterias AAA.

Finition/Finish/Acabado

ABS argent, doré

ABS Silver, gold plated

ABS Plata, dorado.

Utilisation/Use/Utilización

Pour porte d'épaisseur de 38 à 110 mm maxi.

38 to 110 mm maxi thickness door.

38 a 110 mm de espesor de la puerta maxi.

Designation	Boite	Colis.	Prix	Sachet	Colis.	Prix	Brochable					Colis.	Prix
							France	Euro 1	Euro 2	Euro 3	Euro 4		
Judas numérique angle 105° - argent	-	-	-	-	-	-	00012103	-	-	-	-	1	-
Judas numérique angle 105° - doré	-	-	-	-	-	-	00012104	-	-	-	-	1	-

⚠ Non stocké/Non-stored/Producto no estocado - ☑ Sur stock Europe Zone 1 et Zone 2, nous consulter pour délai d'approvisionnement - ☑ Epuisement/Stock depletion/Agotamiento del stock

Equipement de porte / JUDAS VIDEO DIGITALVISA RESIST

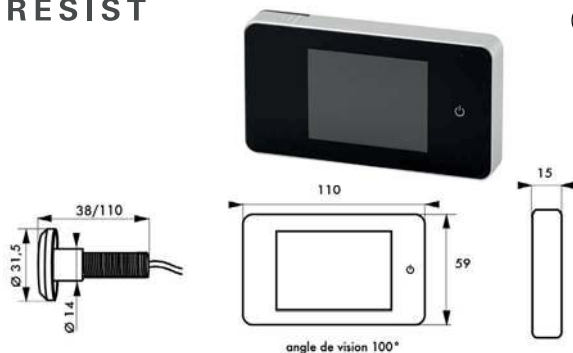

EXITEC
by
THIRARD
FABRICANT DE SECURITE DEPUIS 1920



GARANTIE

Description/Description/Descripción

Corps ABS. Caméra 0,3 méga pixels avec un angle de vision de 110°. Écran vidéo LCD intérieur 3,5». Vision nocturne. Mémorisation horodatée sur carte mémoire Micro SD. Alimentation par 4 piles AA. Avec sonnette.
ABS body. Camera 0,3 mega pixels, view angle 110° - LCD screen 3,5». Night vision. Time-stamped memorization on Micro SD memory card. 4 AA batteries. With door bell.

Cuerpo de ABS. 0,3 mega pixeles de la cámara. Campo de visión 110°. Video de la pantalla 3,5». Visión nocturna. Fecha en la tarjeta de memoria micro SD. Desarrollado por 4 baterias AA. Con timbre.

Finition/Finish/Acabado

ABS argent.

ABS Siver.

ABS Plata.

Utilisation/Use/Utilización

Pour porte d'épaisseur de 38 à 110 mm maxi.

38 to 110 mm maxi thickness door.

38 a 110 mm de espesor de la puerta maxi.

Designation	Boite	Colis.	Prix	Sachet	Colis.	Prix	Brochable					Colis.	Prix
							France	Euro 1	Euro 2	Euro 3	Euro 4		
JUDAS vidéo 110°	-	-	-	-	-	-	00212100	293548 NS	00292548 NS	00294548	-	1	-

Equipement de porte / JUDAS VIDEO DIGITALVISA RESIST

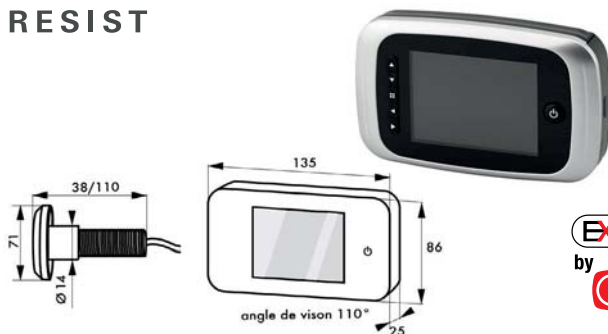

EXITEC
by
THIRARD
FABRICANT DE SECURITE DEPUIS 1920



GARANTIE

Description/Description/Descripción

Corps ABS. Caméra 0,3 méga pixels avec un angle de vision de 110°. Écran vidéo LCD intérieur 3,5». Vision nocturne. Mémorisation horodatée sur carte mémoire Micro SD. Alimentation par 4 piles AA. Avec sonnette.
ABS body. Camera 0,3 mega pixels, view angle 110° - LCD screen 3,5». Night vision. Time-stamped memorization on Micro SD memory card. 4 AA batteries. With door bell.

Cuerpo de ABS. 0,3 mega pixeles de la cámara. Campo de visión 110°. Video de la pantalla 3,5». Visión nocturna. Fecha en la tarjeta de memoria micro SD. Desarrollado por 4 baterias AA. Con timbre.

Finition/Finish/Acabado

ABS argent.

ABS Siver.

ABS Plata.

Utilisation/Use/Utilización

Pour porte d'épaisseur de 38 à 110 mm maxi.

38 to 110 mm maxi thickness door.

38 a 110 mm de espesor de la puerta maxi.

Designation	Boite	Colis.	Prix	Sachet	Colis.	Prix	Brochable					Colis.	Prix
							France	Euro 1	Euro 2	Euro 3	Euro 4		
JUDAS vidéo 110°	-	-	-	-	-	-	00212101	00293721 NS	00292721 NS	00294721	-	1	-

NS Non stocké/Non-stored/Producto no estocado - S Sur stock Europe Zone 1 et Zone 2, nous consulter pour délai d'approvisionnement - E Epuisement/Stock depletion/Agotamiento del stock

Equipement de porte / FERME-PORTE ECO



GARANTIE

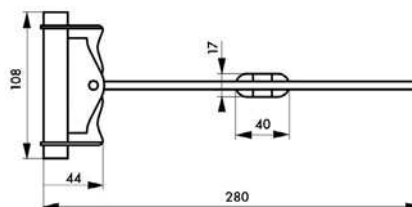

Description/Description/Descripción

Corps et tige acier. Galet coulissant. Réglage possible du mécanisme à ressort. Mécanisme débrayable.

Steel case and arm. Sliding roller. Possible adjustment of the spring mechanism.

Cuerpo y vástago de acero. Rodillo deslizante. Con posibilidad de ajuste del mecanismo de muelle.

Mecanismo desembragable.

Finition/Finish/Acabado

Verni noir

Black varnished

Barnizado negro.

Utilisation/Use/Utilización

Fermeture automatique de porte ouvrant à droite ou à gauche.

Automatic for closing doors, right or left fitting.

Cierre automático de puerta con apertura a la derecha o a la izquierda.

Designation	Boite	Colis.	Prix	Sachet	Colis.	Prix	Brochable					Colis.	Prix
							France	Euro 1	Euro 2	Euro 3	Euro 4		
Ferme-porte à barillet	-	-	-	00998902	20	-	00408902	00493084 NS	00492084 NS	00494084	-	10	-

Equipement de porte / FERME-PORTE ECO



GARANTIE

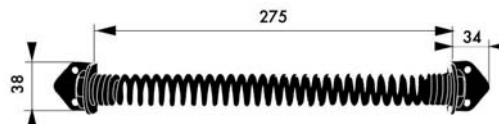

Description/Description/Descripción

Corps acier. Ressort spirale. Longueur 275 mm.

Steel case. Length 275 mm.

Cuerpo de acero. Longitud 275 mm.

Finition/Finish/Acabado

Laqué noir

Black laquered

Lacado negro

Utilisation/Use/Utilización

Fermeture automatique de porte ouvrant à droite ou à gauche.

Automatic for closing doors, right or left fitting.

Cierre automático de puerta con apertura a la derecha o a la izquierda.

Designation	Boite	Colis.	Prix	Sachet	Colis.	Prix	Brochable					Colis.	Prix
							France	Euro 1	Euro 2	Euro 3	Euro 4		
FERME-PORTE à ressort spirale	-	-	-	00908903	20	-	-	00993315 NS	00992315 NS	00994315	-	10	-

NS Non stocké/Non-stored/Producto no estocado - ☑ Sur stock Europe Zone 1 et Zone 2, nous consulter pour délai d'approvisionnement - ☒ Epuisement/Stock depletion/Agotamiento del stock

Equipement de porte / FERME-PORTE ECO



GARANTIE

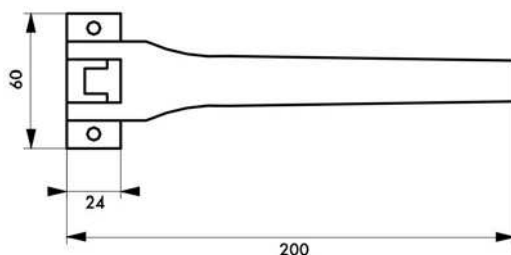

Description/Description/Descripción

Corps alliage anodisé. Réglage de la puissance par vis.
Position d'arrêt automatique à l'équerre possible.
Anodized alloy case. Adjustable regulation of the power by screw. Possible automatic stop position at square angle.
Cuerpo de aleación anodizada. Ajuste de la potencia mediante tornillo. Posibilidad de posición de retén automático en la escuadra.

Finition/Finish/Acabado

Argent, blanc
Silver, white
Plata, blanco

Utilisation/Use/Utilización

Fermeture automatique de porte légère ou mi-lourde.
Ouverture à droite ou à gauche
Automatic closing for light or semi-heavy doors. Right or left fitting.
Cierre automático de puerta ligera o semipesada.
Apertura a la derecha o a la izquierda.

Designation	Boite	Colis.	Prix	Sachet	Colis.	Prix	Brochable					Colis.	Prix
							France	Euro 1	Euro 2	Euro 3	Euro 4		
Ferme-porte AUTOMATIQUE pour porte légère - anodisé argent	-	-	-	00920200	5	-	00420200	-	00492356	-	-	5	-
FERME-PORTE AUTOMATIQUE pour porte légère - blanc	-	-	-	-	-	-	00420202	-	-	-	-	5	-

Non stocké/Non-stored/Producto no estocado - Sur stock Europe Zone 1 et Zone 2, nous consulter pour délai d'approvisionnement - Epuisement/Stock depletion/Agotamiento del stock

Equipement de porte / FERME-PORTE

PROTECT



GARANTIE



Description/Description/Descripción

Corps alliage. Réglage de la puissance. Angle 90° maxi.
Support de tige à visser sur la porte.

Alloy case. Adjustable regulation of the power. Max. 90° angle. Rod's holder to be screwed on the door.

Cuerpo de aleación. Ajuste de la potencia mediante tornillo. Angulo de 90° max. Soporte de varilla artornillable sobre la puerta.

Finition/Finish/Acabado

Blanc, noir

White, black

Blanco, negro

Utilisation/Use/Utilización

Fermeture automatique de porte 10-30kg, largeur 0,80m max. Ouverture à droite ou à gauche

Automatic closing for 10-30kg doors, max width 0,80m.

Right or left fitting.

Cierre automático. de puerta 10-30kg, ancho máximo

0,80m. Apertura a la derecha o a la izquierda.

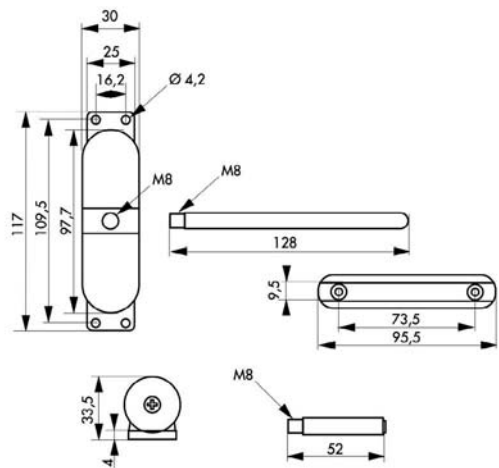

Designation	Boite	Colis.	Prix	Sachet	Colis.	Prix	Brochable					Colis.	Prix
							France	Euro 1	Euro 2	Euro 3	Euro 4		
Ferme-porte automatique pour porte légère - blanc	00008922	1	-	-	-	-	00208922	00293204	00292204	00294204	-	5	-
Ferme-porte automatique pour porte légère - noir	00008923	1	-	-	-	-	00208923	00293206	00292206	00294206	-	5	-

⚠ Non stocké/Non-stored/Producto no estocado - 📦 Sur stock Europe Zone 1 et Zone 2, nous consulter pour délai d'approvisionnement - 🇪🇺 Epuisement/Stock depletion/Agotamiento del stock

Équipement de porte / FERME-PORTE

PROTECT



GARANTIE

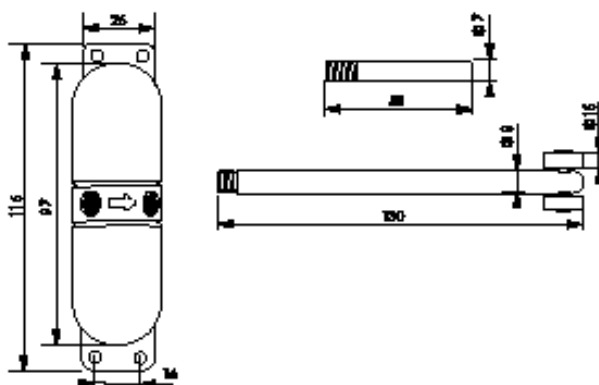

Description/Description/Descripción

Corps alliage. Tige acier avec roulettes. Réglage de la puissance. Angle 90° maxi. Sans support à poser sur la porte.

Alloy case. Steel rod with roller. djustable regulation of the power. Max.90° angle. Without holder. To put on the door.
Cuerpo de aleación. Barra de acero con ruedas. Ajuste de la potencia mediante tornillo. Angulo de 90° max. Sin soporte, planteable sobre la puerta.

Finition/Finish/Acabado

Blanc, noir
White, black
Blanco, negro

Utilisation/Use/Utilización

Fermeture automatique de porte 10-30kg, largeur 0,80m max. Ouverture à droite ou à gauche

Automatic closing for 10-30kg doors, max width 0,80m. Right or left fitting.

Cierre automático. de puerta 10-30kg, ancho máximo 0,80m. Apertura a la derecha o a la izquierda.

Designation	Boite	Colis.	Prix	Sachet	Colis.	Prix	Brochable					Colis.	Prix
							France	Euro 1	Euro 2	Euro 3	Euro 4		
Ferme-porte automatique pour porte légère - noir	00008924	1	-	-	-	-	00208924	00293207	00292207	00294207	-	5	-
Ferme-porte automatique pour porte légère - blanc	00008925	1	-	-	-	-	00208925	00293209	00292209	00294209	-	5	-

⊗ Non stocké/Non-stored/Producto no estocado - ⊠ Sur stock Europe Zone 1 et Zone 2, nous consulter pour délai d'approvisionnement - ⊞ Epuisement/Stock depletion/Agotamiento del stock



Equipement de porte / FERME-PORTE HYDRAULIQUE

ECO



GARANTIE

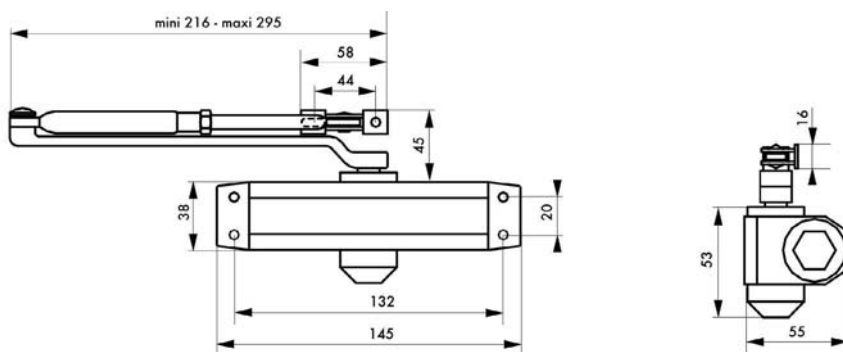

Description/Description/Descripción

Ferme-porte hydraulique. Corps alliage moulé. Montage à droite ou à gauche. Réglage possible de la vitesse de fermeture et de l'à-coup final par vis.

Hydraulic door closer. Moulded alloy body. Right or left fitting. Adjustment of the closing speed and final stop by screw.

Cierrapuertas hidráulico. Cuerpo de aleación moldeada. Montaje a la derecha o a la izquierda. Con ajuste posible de la velocidad de cierre y del impulso final mediante tornillo.

Finition/Finish/Acabado

Laqué gris

Grey laquered

Lacado gris

Version/Option/Versión

093076 : arrêt à 90°.

093076 : Hold open at 90°.

093076 : Cierrapuertas hidráulico con fijación a 90° (con tope).

Utilisation/Use/Utilización

Fermeture automatique de portes < 30 kg.

Automatic closing for doors < 30 kg.

Cierre automático de puertas < 30 kg.

Designation	Boite	Colis.	Prix	Sachet	Colis.	Prix	Brochable					Colis.	Prix
							France	Euro 1	Euro 2	Euro 3	Euro 4		
Ferme-porte hydraulique ECO < 30 kg	00093075	1	-	00993075	5	-	00493075	00493533	00492533	00494533	-	3	-
Ferme-porte hydraulique ECO < 30 kg arrêt à 90°	00093076	1	-	-	-	-	00493076	00493694	00492694	00494694	-	3	-

Non stocké/Non-stored/Producto no estocado - Sur stock Europe Zone 1 et Zone 2, nous consulter pour délai d'approvisionnement - Epuisement/Stock depletion/Agotamiento del stock

Equipement de porte / FERME-PORTE FORCE 3 ET 4

PROTECT



GARANTIE



Force du ferme-porte	largeur recommandée pour la porte mm maxi	masse de la porte KG
1	750	20
2	850	40
3	950	60
4	1100	80
5	1250	100

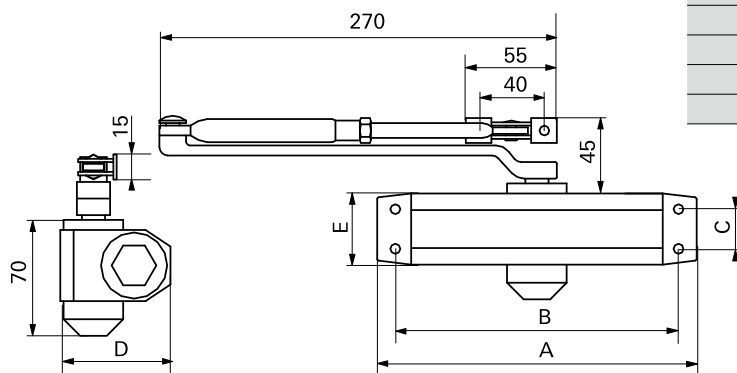

	Force 3	Force 4
A	177	206
B	162	188
C	19	19
D	66	72,5
E	47	44

Description/Description/Descripción

Ferme-porte hydraulique. Corps alliage moulé. Montage à droite ou à gauche. Réglage possible de la vitesse de fermeture et de l'à-coup final par vis.

Hydraulic door closer. Moulded alloy body. Right or left fitting. Adjustment of the closing speed and final stop by screw.

Cierrapuertas hidráulico. Cuerpo de aleación moldeada. Montaje a la derecha o a la izquierda. Con ajuste posible de la velocidad de cierre y del impulso final mediante tornillo.

Finition/Finish/Acabado

Laqué gris, blanc, noir

Grey, white or black lacquered

Lacado gris, blanco o negro

Versión/Option/Versión

Force 3 / Force 4

Force 3 / Force 4

Fuerza 3 / Fuerza 4

Utilisation/Use/Utilización

Fermeture automatique de toutes portes.

Automatic closing for all doors.

Cierre automático de todo tipo de puertas.

Designation	Boite	Colis.	Prix	Sachet	Colis.	Prix	Brochable					Colis.	Prix
							France	Euro 1	Euro 2	Euro 3	Euro 4		
Ferme-porte hydraulique. ECO argent force 3	00094075	1	-	00994075	5	-	00494075	00493090 NS	00492090 NS	00494090	-	3	-
Ferme-porte hydraulique. ECO blanc force 3	00094070	1	-	00994070	5	-	00494070	00493212 NS	00492212 NS	00494212	-	3	-
Ferme-porte hydraulique. ECO noir force 3	00094074	1	-	-	-	-	-	-	-	-	-	-	-
Ferme-porte hydraulique. ECO argent force 4	00095075	1	-	00995075	5	-	00495075	00493091 NS	00492091 NS	00494091	-	3	-
Ferme-porte hydraulique. ECO blanc force 4	00095070	1	-	-	-	-	-	-	-	-	-	-	-
Ferme-porte hydraulique. ECO noir force 4	00095074	1	-	-	-	-	-	-	-	-	-	-	-

NS Non stocké/Non-stored/Producto no estocado - Sur stock Europe Zone 1 et Zone 2, nous consulter pour délai d'approvisionnement - E Epuïsement/Stock depletion/Agotamiento del stock

Equipement de porte / FERME-PORTE FORCE 5

PROTECT



GARANTIE



Force du ferme-porte	largeur recommandée pour la porte mm maxi	masse de la porte KG
1	750	20
2	850	40
3	950	60
4	1100	80
5	1250	100

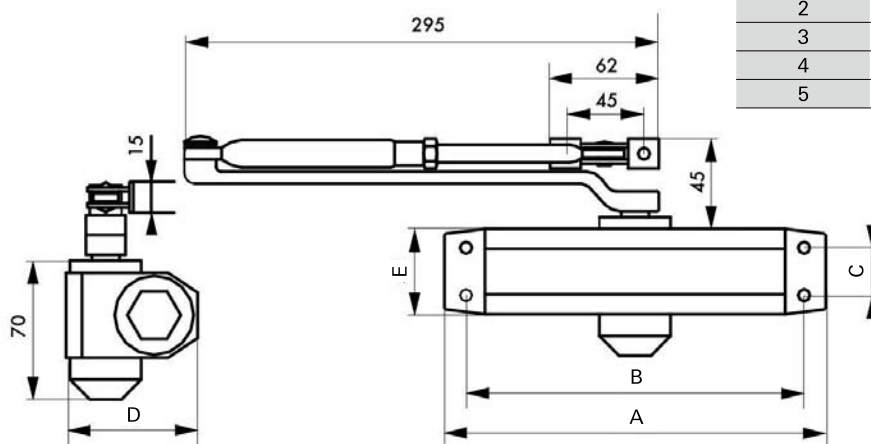

	Force 5
A	225
B	207
C	19
D	66
E	45

Description/Description/Descripción

Ferme-porte hydraulique. Corps alliage moulé. Montage à droite ou à gauche. Réglage possible de la vitesse de fermeture et de l'à-coup final par vis.

Hydraulic door closer. Moulded alloy body. Right or left fitting. Adjustment of the closing speed and final stop by screw.

Cierrapuertas hidráulico. Cuerpo de aleación moldeada. Montaje a la derecha o a la izquierda. Con ajuste posible de la velocidad de cierre y del impulso final mediante tornillo.

Finition/Finish/Acabado

Laqué gris, blanc, noir
Grey, white or black lacquered
Lacado gris, blanco o negro

Utilisation/Use/Utilización

Fermeture automatique de toutes portes.
Automatic closing for all doors.

Cierre automático de todo tipo de puertas.

Designation	Boite	Colis.	Prix	Sachet	Colis.	Prix	Brochable					Colis.	Prix
							France	Euro 1	Euro 2	Euro 3	Euro 4		
Ferme-porte hydraulique. ECO noir force 5	00013911	1	-	-	-	-	-	-	-	-	-	-	-
Ferme-porte hydraulique. ECO blanc force 5	00013912	1	-	-	-	-	-	-	-	-	-	-	-
Ferme-porte hydraulique. ECO argent force 5	00013910	1	-	-	-	-	-	-	-	-	-	-	-

Ⓜ Non stocké/Non-stored/Producto no estocado - ☑ Sur stock Europe Zone 1 et Zone 2, nous consulter pour délai d'approvisionnement - ☒ Epuisement/Stock depletion/Agotamiento del stock

Equipement de porte / FERME-PORTE A CAME RESIST



GARANTIE



EN1154:1996
'A1:2002/AC:2006
Classification

4	8	5	1*	1	3
		2			

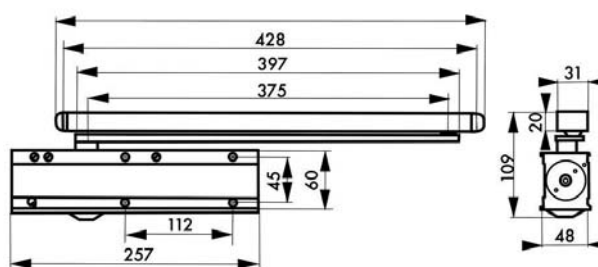

Description/Description/Descripción

Ferme porte automatique à came et contre piston, corps en alliage moulé avec capot, montage à droite ou à gauche. Angle d'ouverture maxi 180°. Force réglable N° 2 à 5. Pour porte largeur maxi 1250 mm / Maxi 100kgs. Vitesse de fermeture et à coup final réglable par vis. Freinage à l'ouverture - retard à la fermeture réglable par vis. Livré avec bras glissière et plaque de montage. Accessoires : Plaque de fixation / Limitateur d'ouverture / Arrêt de porte

Automatic door closer with came action system, moulded alloy body with cover, right or left fitting. Adjustable power size 2-5 for max door 1250mm. Opening angle 180° maxi. Adjustable closing & latching speed. Thermo-constant valve. Adjustable back check. Adjustable delay action with Track arm mechanism. Accessories : Mounting plate / Cushion limit stay / Hold open device.

Cierra puertas automatico con leva y contra pistón, cuerpo de aleación moldeada con capuchón, montaje a derecha o a izquierda. Ángulo de apertura máxima 180°.

Fuerza ajustable N° 2 a 5. Para puerta ancho máximo 1250 mm / Maximo 100kgs. Cierra puertas automatico con leva y contra pistón, cuerpo de aleación moldeada con capuchón, montaje a derecha o a izquierda. Ángulo de apertura máxima 180°. Fuerza ajustable N° 2 a 5. Para puerta ancho máximo 1250 mm / Maximo 100kgs. Accesorios : Placa de fijación / limitador de apertura / Tope de puerta.

Finition/Finish/Acabado

Alu anodisé argent
Aluminium anodised
Aluminio anodizado

Utilisation/Use/Utilización

Fermeture automatique de toutes portes.
Automatic closing for all doors.
Cierre automático de todo tipo de puertas.

Designation	Boite	Colis.	Prix	Sachet	Colis.	Prix	Brochable					Colis.	Prix
							France	Euro 1	Euro 2	Euro 3	Euro 4		
Ferme-porte à came	00000989	1	-	-	-	-	-	-	-	-	-	-	-
Limitateur d'ouverture	00000991	1	-	-	-	-	-	-	-	-	-	-	-
Arrêt de porte	00000992	1	-	-	-	-	-	-	-	-	-	-	-

⊗ Non stocké/Non-stored/Producto no estocado - ⊗ Sur stock Europe Zone 1 et Zone 2, nous consulter pour délai d'approvisionnement - ⊗ Epuiseiment/Stock depletion/Agotamiento del stock

Equipement de porte / FERME-PORTE

RESIST



GARANTIE

Description/Description/Descripción

Ferme-porte hydraulique à crémaillère. Appareil léger à encombrement réduit. Pose à droite ou à gauche. Régulation thermique automatique de -15° à +40°. Réglage de la vitesse de fermeture et de l'à-coup final par vis. Accessoires : Patte de fixation pour montage bras parallèles.

Hydraulic door closer with toothed rack. Light device with reduced measures right or left fitting. Automatic thermic adjustment from -15° to +40°. Adjustment of the closing speed and final stop by screw. Accessoires : Mounting foot for assembly parallel arms.

Cierrapuertas hidráulico de cremallera. Aparato ligero de reducido volumen. Montaje a la derecha o a la izquierda. Regulación térmica automática de -15° a +40°. Ajuste de la velocidad de cierre y del impulso final mediante tornillo. Accesorios : Pierna de fijación para montaje brazos paralelos.

Finition/Finish/Acabado

Aluminium anodisé argent. Laqué blanc, noir. Anodized aluminium body. White, black. Aluminio anodizado plata. Blanco, negro.

Versión/Option/Versión

Force 3 avec bras standard fixation invisible. Force 3 avec bras antivandalisme fixation invisible. Force réglable 2 à 4 fixation invisible. Force 3 bras standard.

Force 3 with standard arm invisible fixing. Forces 3 with arm invisible antivandalism fixing. Power adjustable 2 to 4 invisible fixing Force. Accessories Mounting foot for assembly parallel arms.

Fuerza 3 con brazos normales fijación invisible. Fuerza 3 con brazo antivandalisme . fijación invisible. Fuerza ajustable 2 a 4 fijación invisible. Fuerza 3 brazos normales.

Utilisation/Use/Utilización

Fermeture automatique de toutes portes. Automatic closing for all doors.

Cierre automático de todo tipo de puertas.

Designation	Boite	Colis.	Prix	Sachet	Colis.	Prix	Brochable					Colis.	Prix
							France	Euro 1	Euro 2	Euro 3	Euro 4		
Ferme-porte hydraulique DESIGN réversible argent avec bras standard force 3	00000981	1	-	-	-	-	-	-	-	-	-	-	-
Ferme-porte hydraulique DESIGN réversible blanc avec bras standard force 3	00000982	1	-	-	-	-	-	-	-	-	-	-	-
Ferme-porte hydraulique DESIGN réversible noir avec bras standard force 3	00001982	1	-	-	-	-	-	-	-	-	-	-	-
Ferme-porte hydraulique DESIGN réversible argent avec bras coulisse antivandalisme force 3	00000983	1	-	-	-	-	-	-	-	-	-	-	-
Ferme-porte hydraulique DESIGN réversible blanc avec bras coulisse antivandalisme force 3	00000984	1	-	-	-	-	-	-	-	-	-	-	-
Ferme-porte hydraulique DESIGN réversible noir avec bras coulisse antivandalisme force 3	00001984	1	-	-	-	-	-	-	-	-	-	-	-
Ferme-porte hydraulique DESIGN réversible argent avec bras standard force 2 à 4	00000987	1	-	-	-	-	-	-	-	-	-	-	-

⚠ Non stocké/Non-stored/Producto no estocado - 📦 Sur stock Europe Zone 1 et Zone 2, nous consulter pour délai d'approvisionnement - 🇪🇺 Epuisement/Stock depletion/Agotamiento del stock

Equipement de porte / FERME-PORTE

RESIST



Designation	Boite	Colis.	Prix	Sachet	Colis.	Prix	Brochable					Colis.	Prix
							France	Euro 1	Euro 2	Euro 3	Euro 4		
Ferme-porte hydraulique DESIGN réversible blanc avec bras standard force 2 à 4	00000988	1	-	-	-	-	-	-	-	-	-	-	-
Ferme-porte hydraulique DESIGN réversible noir avec bras standard force 2 à 4	00001988	1	-	-	-	-	-	-	-	-	-	-	-
Patte de fixation pour montage bras parallèles argent	00000917	1	-	-	-	-	-	-	-	-	-	-	-
Patte de fixation pour montage bras parallèles blanc	00000910	1	-	-	-	-	-	-	-	-	-	-	-
Ferme-porte hydraulique réversible argent force 3	00096075	1	-	-	-	-	-	-	-	-	-	-	-
Ferme-porte hydraulique réversible noir force 3	00096074	1	-	-	-	-	-	-	-	-	-	-	-
Ferme-porte hydraulique réversible blanc force 3	00096070	1	-	-	-	-	-	-	-	-	-	-	-



	000981 / 000982	000983 / 000984	000987 / 000988
A	74	77	77
B	206	233	233
C	100	101	101 (109 avec la vis)
D	39	43	43
E	55	61	61
F	50	50	50
G	39	45	45
H	142	148	149

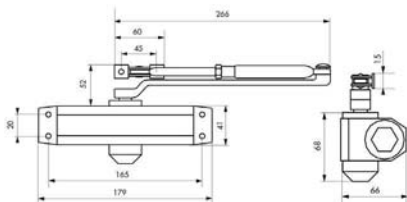
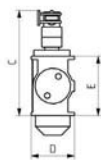
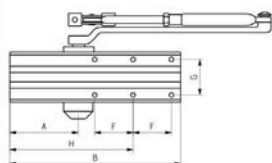

Force du ferme-porte	largeur recommandée pour la porte mm maxi	masse de la porte KG
1	750	20
2	850	40
3	950	60
4	1100	80
5	1250	100

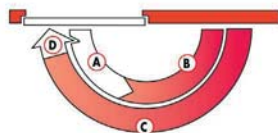

A - Ouverture régulée jusqu'à 70° environ
 B - Frein d'ouverture de 70° environ à 180°
 C - 1^{er} réglage de la vitesse de fermeture de 180° à 15° environ
 D - 2^e réglage de l'à-coup final à partir de 15°

A - Regular opening from 0° - approx. 70°
 B - Opening brake from 70° to 180°
 C - 1st adjustable closing range from 180° - approx. 15°
 D - 2nd adjustable final closing range from 15°

A - Apertura regulada hasta 70° aproximadamente
 B - Freno de apertura de 70° aproximadamente a 180°
 C - 1er ajuste de la velocidad de cierre de 180° a 15° aproximadamente
 D - 2º ajuste del impulso final a partir de 15°

Pose / Installation / Instalación

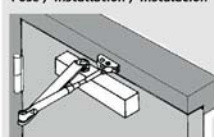

- côté intérieur en tirant
- on pull side
- lado interior tirando

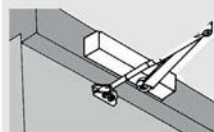

- côté intérieur en poussant
- on push side
- lado interior empujando

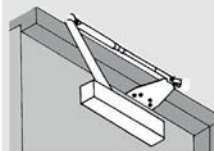

- côté intérieur en poussant (avec patte spéciale)
- on push side (with parallel arm installation)
- lado interior empujando (con patilla especial)

Le marquage CE est obligatoire sur tous les ferme-portes aptes à équiper des blocs portes coupe feu et dans les ERP (Etablissement Recevant du Public) ainsi que les IGH (Immeubles de Grande Hauteur)

Référence : 000981-000982-001982-000987-000988-001988

EN 1154:1996 /A1:2002/AC:2006 Classification

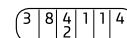

Référence : 096075-096070-096074

EN 1154:1996 /A1:2002/AC:2006 Classification

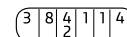

Référence : 000983-0009840-001984

EN 1154:1996 /A1:2002/AC:2006 Classification

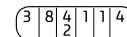

Equipement de porte / CÂLE DE PORTE ECO



GARANTIE

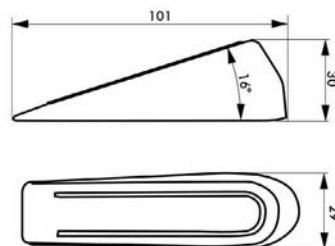

Description/Description/Descripción

Corps ABS. / ABS body. / Cuerpo de ABS

Finition/Finish/Acabado

Marron / Brown / Marrón

Versión/Option/Versión

Conditionnement boîte par 1 pièce. Conditionnement bac et coque par 2 pièces.

Individually boxed. Stand and clamshell packed

Preparación en caja por 1 pieza. Preparación en contenedor y paquete por 2 piezas.

Utilisation/Use/Utilización

Pour maintenir la porte en position ouverte.

Allows to keep the door open.

Permite mantener la puerta en posición abierta.

Designation	Boite	Colis.	Prix	Sachet	Colis.	Prix	Brochable					Colis.	Prix
							France	Euro 1	Euro 2	Euro 3	Euro 4		
Lot de 2 câles de porte marron	00002025	10	-	00902025	10	-	00202025	00293639 NS	00292639 NS	00294639	-	-	-

Equipement de porte / CÂLE DE PORTE ECO



GARANTIE

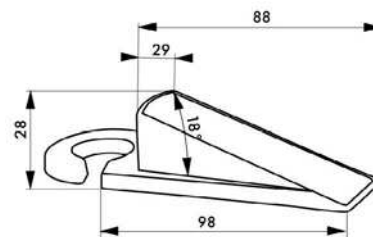

Description/Description/Descripción

Corps PVC. Accroche poignées.

ABS body.

Cuerpo de ABS

Finition/Finish/Acabado

Blanc

White

Blanco

Utilisation/Use/Utilización

Pour maintenir la porte en position ouverte.

Allows to keep the door open.

Permite mantener la puerta en posición abierta.

Designation	Boite	Colis.	Prix	Sachet	Colis.	Prix	Brochable					Colis.	Prix
							France	Euro 1	Euro 2	Euro 3	Euro 4		
Câle de porte blanc avec accroche poignée	-	-	-	00902026	10	-	00202026	00293805 NS	00292805 NS	00294805	-	10	-

NS Non stocké/Non-stored/Producto no estocado - ☑ Sur stock Europe Zone 1 et Zone 2, nous consulter pour délai d'approvisionnement - E Epusement/Stock depletion/Agotamiento del stock

Equipement de porte / CÂLE DE PORTE PROTECT



GARANTIE



Description/Description/Descripción

Corps bambou. Semelle caoutchouc.
Bamboo body. Rubber sole.
Cuerpo de bambù. Suela de goma.

Finition/Finish/Acabado

Bambou naturel.
Natural bamboo
Bambù natural.

Utilisation/Use/Utilización

Pour maintenir la porte en position ouverte.
Allows to keep the door open.
Permite mantener la puerta en posición abierta.



Designation	Boite	Colis.	Prix	Sachet	Colis.	Prix	Brochable					Colis.	Prix
							France	Euro 1	Euro 2	Euro 3	Euro 4		
CÂLE de porte bambou	-	-	-	00902023	10	-	00202023	00293511 NSI	00292511 NS	00294511	-	10	-

Equipement de porte / CÂLE DE PORTE PROTECT



GARANTIE

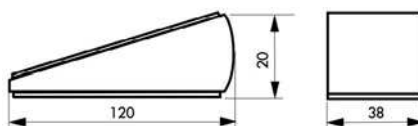

Description/Description/Descripción

Corps alliage. Semelle caoutchouc.
Alloy body. Rubber sole.
Cuerpo de aleación. Suela de goma.

Finition/Finish/Acabado

Nickelé brossé.
Nickel brushed.
Niquel cepillado.

Utilisation/Use/Utilización

Pour maintenir la porte en position ouverte.
Allows to keep the door open.
Permite mantener la puerta en posición abierta.

Designation	Boite	Colis.	Prix	Sachet	Colis.	Prix	Brochable					Colis.	Prix
							France	Euro 1	Euro 2	Euro 3	Euro 4		
CÂLE de porte nickelée brossée	-	-	-	00902021	10	-	00202021	00293381	00292381	00294381	-	10	-

NS Non stocké/Non-stored/Producto no estocado - SI Sur stock Europe Zone 1 et Zone 2, nous consulter pour délai d'approvisionnement - E Epuisement/Stock depletion/Agotamiento del stock

Equipement de porte / ARRÊT DE PORTE ECO



GARANTIE

Description/Description/Descripción

Corps alliage moulé. Frein caoutchouc.

Alloy case. Rubber end.

Cuerpo de aleación moldeada. Freno de caucho.

Finition/Finish/Acabado

Argent, blanc

Silver, white

Plata, bBlanco

Utilisation/Use/Utilización

Permet de maintenir la porte (< 60 kg) en position

ouverte. Spécialement utilisé pour porte battante.

Blocage, déblocage avec le pied.

Allows to keep the door open. Specially used on swing door. Locking, unlocking with the foot.

Permite mantener la puerta en posición abierta.

Utilizado especialmente para puerta batiente. Bloqueo y desbloqueo con el pie.

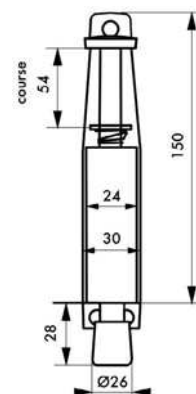

Designation	Boite	Colis.	Prix	Sachet	Colis.	Prix	Brochable					Colis.	Prix
							France	Euro 1	Euro 2	Euro 3	Euro 4		
ARRÊT DE PORTE argent 150 mm	0000804	10	-	00900804	10	-	00400804	00493085 NS	00492085 NS	00494085	-	10	-
ARRÊT DE PORTE laqué blanc 150 mm	00009804	10	-	-	-	-	00409804	-	-	-	-	10	-
EMBOUT pour ARRÊT DE PORTE 150 mm	0000884	10	-	-	-	-	-	-	-	-	-	-	-

Equipement de porte / ARRÊT DE PORTE PROTECT



GARANTIE

Description/Description/Descripción

Corps alliage moulé. Frein caoutchouc.

Alloy case. Rubber end.

Cuerpo de aleación moldeada. Freno de caucho.

Finition/Finish/Acabado

Argent, blanc

Silver, white

Plata, bBlanco

Utilisation/Use/Utilización

Permet de maintenir la porte (< 60 kg) en position

ouverte. Spécialement utilisé pour porte battante.

Blocage, déblocage avec le pied.

Allows to keep the door open. Specially used on swing door. Locking, unlocking with the foot.

Permite mantener la puerta en posición abierta.

Utilizado especialmente para puerta batiente. Bloqueo y desbloqueo con el pie.

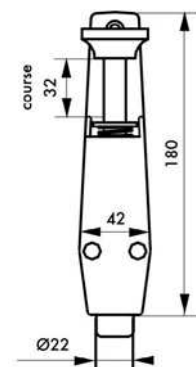

Designation	Boite	Colis.	Prix	Sachet	Colis.	Prix	Brochable					Colis.	Prix
							France	Euro 1	Euro 2	Euro 3	Euro 4		
ARRÊT DE PORTE 180 mm laqué argent	00092804	10	-	00992804	10	-	00492804	-	-	-	-	10	-
ARRÊT DE PORTE 180 mm laqué blanc	00093804	10	-	00993804	10	-	00493804	00493092 NS	00492092 NS	00494092	-	10	-
EMBOUT pour ARRÊT DE PORTE 180 mm	00092884	10	-	-	-	-	-	-	-	-	-	-	-

NS Non stocké/Non-stored/Producto no estocado - ☑ Sur stock Europe Zone 1 et Zone 2, nous consulter pour délai d'approvisionnement - E Epusement/Stock depletion/Agotamiento del stock

Equipement de porte / ARRÊT DE PORTE

RESIST

Description/Description/Descripción

Corps inox. Frein caoutchouc.

Stainlees steel case. Rubber end.

Cuerpo de acero inoxidable. Freno de caucho.

Finition/Finish/Acabado

Inox

Stainlees steel

Acero inoxidable

Utilisation/Use/Utilización

Permet de maintenir la porte (< 60 kg) en position ouverte. Spécialement utilisé pour porte battante.

Blocage, déblocage avec le pied.

Allows to keep the door open. Specially used on swing door. Locking, unlocking with the foot.

Permite mantener la puerta en posición abierta.

Utilizado especialmente para puerta batiente. Bloqueo y desbloqueo con el pie.

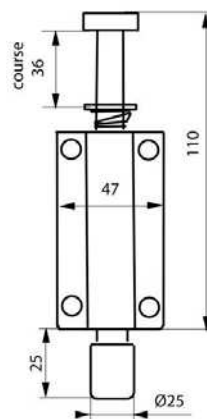

GARANTIE

Designation	Boite	Colis.	Prix	Sachet	Colis.	Prix	Brochable					Colis.	Prix
							France	Euro 1	Euro 2	Euro 3	Euro 4		
ARRÊT DE PORTE inox 140 mm	-	-	-	00900805	10	-	00400805	00493638 NS	00492638 NS	00494638	-	10	-

Equipement de porte / VERROU BAÏONETTE

ECO

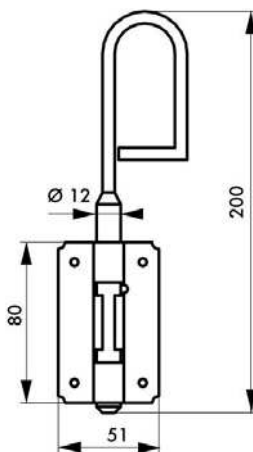

GARANTIE

Description/Description/Descripción

Platine acier cambré. Pêne rond coulissant.

Cambered steel plate. Sliding round bolt.

Pletina de acero curvado. Pestillo redondo deslizante.

Finition/Finish/Acabado

Zingué

Zinc coated

Cincado

Designation	Boite	Colis.	Prix	Sachet	Colis.	Prix	Brochable					Colis.	Prix
							France	Euro 1	Euro 2	Euro 3	Euro 4		
VERROU BAÏONNETTE 12 x 200 mm	00012200	10	-	00912200	20	-	00412200	00493110 NS	00492110 NS	00494110	-	10	-

NS Non stocké/Non-stored/Producto no estocado - Sur stock Europe Zone 1 et Zone 2, nous consulter pour délai d'approvisionnement - E Epuisement/Stock depletion/Agotamiento del stock

Equipement de porte / VERROU A PLAQUER ECO



GARANTIE

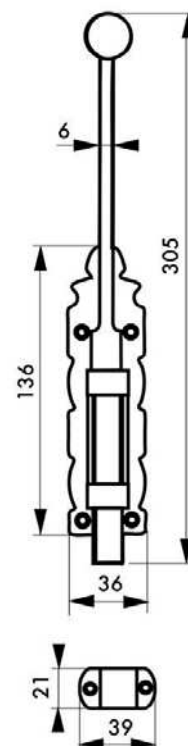
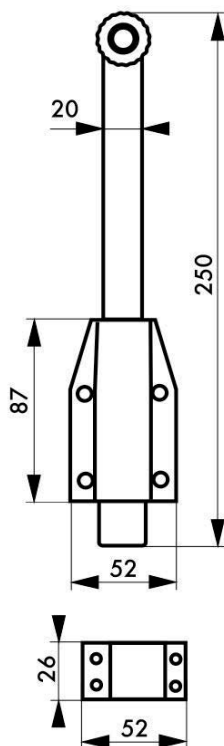

Description/Description/Descripción

Corps et gâche à plaquer acier. Gâche plate Pêne plat coulissant.

Steel case and striker. Flat striker Sliding flat bolt.

Cuerpo y cerradero de plastrón de acero. Cerradero plano. Pestillo plano deslizante.

Finition/Finish/Acabado

028022 - Zingué blanc

409034 - Laqué noir

028022 - zinc bichromated plated

409034 - black lacquered

028022 - cincado bicromatado

409034 - lacado negro

Designation	Boite	Colis.	Prix	Sachet	Colis.	Prix	Brochable					Colis.	Prix
							France	Euro 1	Euro 2	Euro 3	Euro 4		
VERROU A PLAQUER 250 mm	00028022	10	-	00928022	20	-	00428022	00493109 NS	00492109 NS	00494109	-	10	-
VERROU A PLAQUER RUSTIQUE 305 mm	-	-	-	-	-	-	00409034	00493321 NS	00492321 NS	00494321	-	10	-

NS Non stocké/Non-stored/Producto no estocado - S Sur stock Europe Zone 1 et Zone 2, nous consulter pour délai d'approvisionnement - E Epusement/Stock depletion/Agotamiento del stock

Equipement de porte / VERROU VERTICAL ECO



GARANTIE

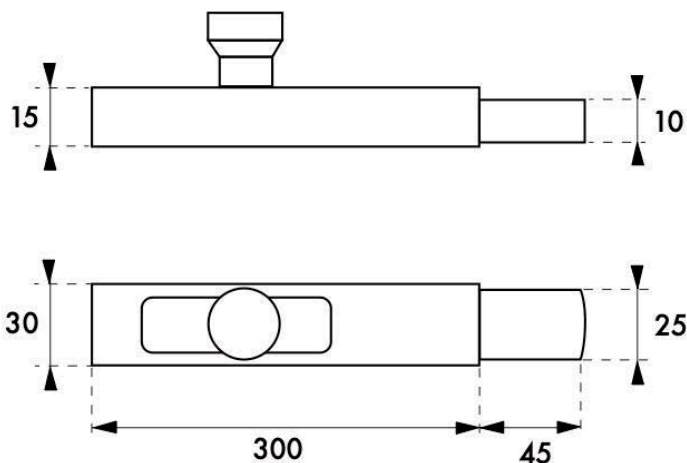

Description/Description/Descripción

Corps acier. Pêne plat coulissant. Bouton rond.

Steel case. Sliding fl at bolt. Round knob.

Cuerpo de acero. Pestillo plano deslizante. Botón redondo.

Finition/Finish/Acabado

Zingué

Zinc coated

Cincado

Utilisation/Use/Utilización

Pour portails, barrières.

For gates, barriers. Ideal.

Para puertas, barreras.

Designation	Boite	Colis.	Prix	Sachet	Colis.	Prix	Brochable					Colis.	Prix
							France	Euro 1	Euro 2	Euro 3	Euro 4		
Verrou vertical lourd a souder zingue 300mm	-	-	-	00912250	1	-	-	-	-	-	-	-	-

⚠ Non stocké/Non-stored/Producto no estocado - 📦 Sur stock Europe Zone 1 et Zone 2, nous consulter pour délai d'approvisionnement - 🇪🇺 Epuement/Stock depletion/Agotamiento del stock

Equipement de porte / VERROU A PLAQUER

PROTECT



GARANTIE

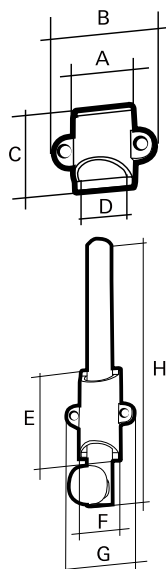

	004151	004152	004153	004154	004155
A	24	24	24	24	24
B	41	41	41	41	41
C	32,5	32,5	32,5	32,5	32,5
D	18,5	18,5	18,5	18,5	18,5
E	53	53	53	53	53
F	24	24	24	24	24
G	41	41	41	41	41
H	99,5	149	199	248	297

Description/Description/Descripción

Verrou à plaquer à coulisse. Corps alliage. Pêne 1/2 rond.
 Flush-mounted sliding bolt. Alloy body. 1/2 round bolt.
 Pasador de plastrón deslizante. Cuerpo de aleación.
 Pestillo 1/2 redondo

Finition/Finish/Acabado

Nickel satin
 Nickel satin
 Níquel satinado

Utilisation/Use/Utilización

Porte et fenêtre.
 Door and window.
 Puerta y ventan

Designation	Boite	Colis.	Prix	Sachet	Colis.	Prix	Brochable					Colis.	Prix
							France	Euro 1	Euro 2	Euro 3	Euro 4		
VERROU A PLAQUER 100 MM	00004151	10	-	-	-	-	00104151	00193912 NS	00192912 NS	00194912	-	10	-
VERROU A PLAQUER 150 MM	00004152	10	-	-	-	-	00204152	00293913 NS	00292913 NS	00294913	-	10	-
VERROU A PLAQUER 200 MM	00004153	10	-	00904153	10	-	204153	00293915 NS	00292915 NS	00294915	-	10	-
VERROU A PLAQUER 250 MM	00004154	10	-	-	-	-	00404154	493916 NS	00492916 NS	00494916	-	10	-
VERROU A PLAQUER 300 MM	00004155	10	-	00904155	10	-	00404155	493918 NS	00492918 NS	00494918	-	10	-

NS Non stocké/Non-stored/Producto no estocado - ☐ Sur stock Europe Zone 1 et Zone 2, nous consulter pour délai d'approvisionnement - ☒ Epuisement/Stock depletion/Agotamiento del stock

Equipement de porte / VERROU VERTICAL

ECO



GARANTIE

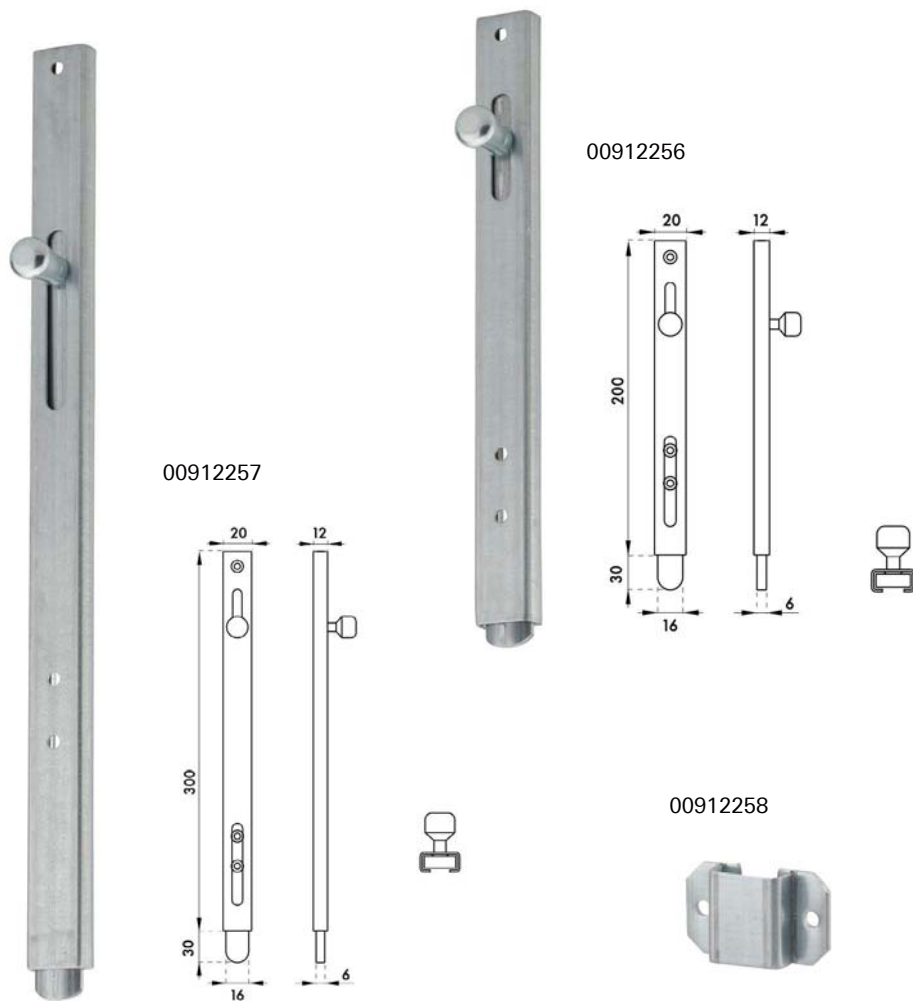

Description/Description/Descripción

Corps acier cambré. Pêne plat coulissant. Bouton rond.
Cambered steel case. Sliding fl at bolt. Round knob.
 Cuerpo de acero. Pestillo plano deslizante. Botón redondo.

Finition/Finish/Acabado

Zingué
Zinc coated
 Cincado

Version/Option/Versión

A visser / A souder .
To be screwed / welded.
 Atornillable / soldable.

Utilisation/Use/Utilización

Porte et fenêtre.
Door and window.
 Puerta y ventan

Designation	Boîte	Colis.	Prix	Sachet	Colis.	Prix	Brochable					Colis.	Prix
							France	Euro 1	Euro 2	Euro 3	Euro 4		
Verrou vertical léger zingué a visser 200mm	-	-	-	00912256	1	-	-	-	-	-	-	-	-
Verrou vertical léger zingué a visser 300mm	-	-	-	00912257	1	-	-	-	-	-	-	-	-
Butee bas a visser art.256 / 20mm	-	-	-	00912258	1	-	-	-	-	-	-	-	-

⊗ Non stocké/Non-stored/Producto no estocado - ⊠ Sur stock Europe Zone 1 et Zone 2, nous consulter pour délai d'approvisionnement - ⊞ Equipement/Stock depletion/Agotamiento del stock

Equipement de porte / LOQUETEAU ALSACIEN ECO



GARANTIE

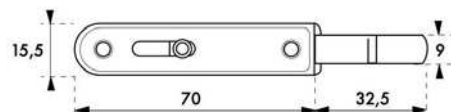
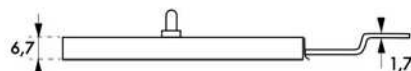
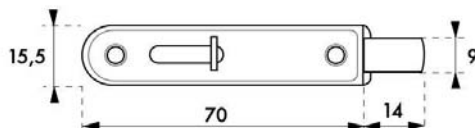
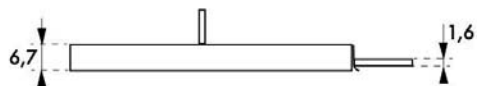

Description/Description/Descripción

Acier, pêne plat coulissant.

Steel, sliding fl at bolt.

Acero, pestillo plano deslizante.

Finition/Finish/Acabado

Zingué.

Zinc plated.

Cincado.

Designation	Boite	Colis.	Prix	Sachet	Colis.	Prix	Brochable					Colis.	Prix
							France	Euro 1	Euro 2	Euro 3	Euro 4		
Loqueteau alsacien 75x15mm	-	-	-	00987648	1	-	00187648	-	-	-	-	1	-
Loqueteau alsacien 75x15mm poudé	-	-	-	00987649	1	-	00187649	-	-	-	-	1	-

⚠ Non stocké/Non-stored/Producto no estocado - ☑ Sur stock Europe Zone 1 et Zone 2, nous consulter pour délai d'approvisionnement - ☒ Epuisement/Stock depletion/Agotamiento del stock

Equipement de porte / VERROU A ONGLET ECO



GARANTIE

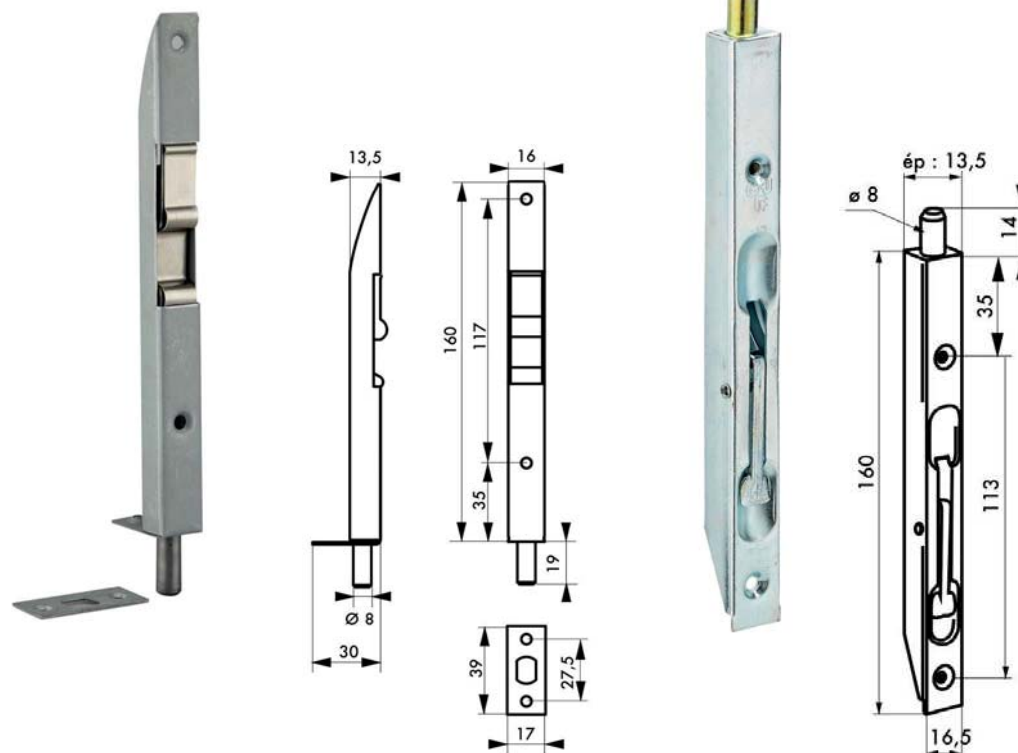

Description/Description/Descripción

Platine acier cambré. Pêne rond coulissant.
Cambered steel plate. Sliding round bolt.
Pletina de acero curvado. Pestillo redondo deslizante.

Finition/Finish/Acabado

Zingué
Zinc coated
Cincado

Version/Option/Versión

A bascule. Conditionnement sachet cavalier 213948 - 213949.
With toggle. Packed in polybag with head card 213948 - 213949
Pestillo de palanca. Embalado en una bolsa colgable 213948 - 213949

Utilisation/Use/Utilización

Porte et fenêtre.
Door and window.
Puerta y ventan

Designation	Boite	Colis.	Prix	Sachet	Colis.	Prix	Brochable					Colis.	Prix
							France	Euro 1	Euro 2	Euro 3	Euro 4		
VERROU A ongles 160 mm	00059160	10	-	-	-	-	00259160	293567	-	-	-	10	-
VERROU A ongles 200 mm	00013948	10	-	-	-	-	00213948	293568	-	-	-	10	-
VERROU A ongles à bascule 160 mm	00013949	10	-	-	-	-	00213949	293569	-	-	-	10	-

⊠ Non stocké/Non-stored/Producto no estocado - ⊠ Sur stock Europe Zone 1 et Zone 2, nous consulter pour délai d'approvisionnement - ⊠ Epuisement/Stock depletion/Agotamiento del stock

Equipement de porte / BUTOIR

ECO



GARANTIE

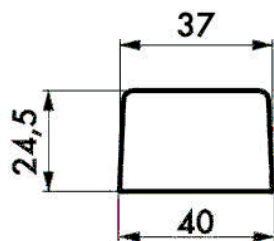

Possibilité d'utilisation de ces butoirs de porte au sol ou au mur.

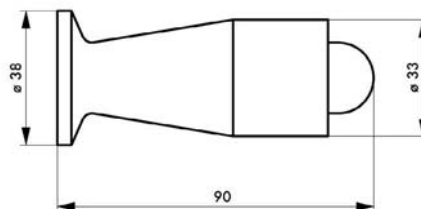
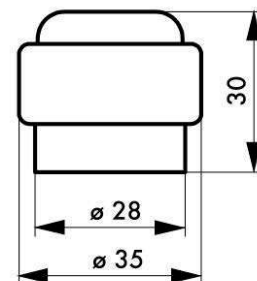

Description/Description/Descripción

Monture plastique. Bague souple ou caoutchouc.

Plastic frame. Flexible or rubber ring.

Montura de plástico. Anillo flexible de caucho.

Finition/Finish/Acabado

Deux tons : marron / beige

2 colours : brown / natural

Dos tonos: marrón y beige

Version/Option/Versión

Caoutchouc noir/Butoir balustre pour fixation sur mur.

Butoir pour fixation au sol. 900037-100037 vis (5x20)

fournie sous conditionnement bac et coque. 100021 vis (4x50) fournie sous conditionnement coque.

Black rubber. Stop for fixing on the wall or on the floor 900037-100037 screw (5x20) polybag and blister packing. 100021 screw (4x50) blister packing.

Black rubber. Stop for fixing on the wall or on the floor 900037-100037 screw (5x20) polybag and blister packing. 100021 screw (4x50) blister packing.

Utilisation/Use/Utilización

Eviter les chocs de la porte contre le mur.

Avoids the shocks door / wall.

Evita los golpes de la puerta contra la pared.

Designation	Boite	Colis.	Prix	Sachet	Colis.	Prix	Brochable					Colis.	Prix
							France	Euro 1	Euro 2	Euro 3	Euro 4		
Butoir de sol Ø 35 mm plastique	00000021	10	-	00900021	30	-	00100021	00193087 NS	00192087 NS	00194087	-	10	-
Butoir balustre 90 mm monture plastique	00000037	10	-	00900037	30	-	00100037	00193086 NS	00192086 NS	00194086	-	10	-
Butoir de sol caoutchouc	00000025	10	-	00900025	30	-	-	-	00192088 NS	-	-	10	-

NS Non stocké/Non-stored/Producto no estocado - ☐ Sur stock Europe Zone 1 et Zone 2, nous consulter pour délai d'approvisionnement - E Epuisement/Stock depletion/Agotamiento del stock

Equipement de porte / BUTOIR

ECO



GARANTIE

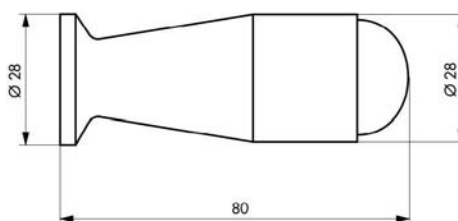
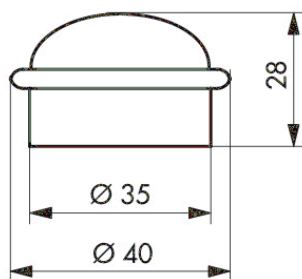

Description/Description/Descripción

Monture bois. Bague souple ou caoutchouc.
Wood frame. Flexible or rubber ring.
Montura de madera. Anillo flexible de caucho.

Finition/Finish/Acabado

Bois
Wood
Madera

Version/Option/Versión

Butoir balustre pour fixation sur mur.
Stop for fixing on the wall.
Tope balaustra para fijación en la pared.

Utilisation/Use/Utilización

Eviter les chocs de la porte contre le mur.
Avoids the shocks door / wall.
Evita los golpes de la puerta contra la pared.

Designation	Boite	Colis.	Prix	Sachet	Colis.	Prix	Brochable				Colis.	Prix	
							France	Euro 1	Euro 2	Euro 3			Euro 4
Butoir de sol Ø 35 mm bois	00000026	20	-	-	-	-	00100026	193911 NS	00192911 NS	00194911	-	10	-
Butoir balustre 80 mm bois	00000039	20	-	-	-	-	00100039	00193913 NS	00192913 NS	00194913	-	10	-

NS Non stocké/Non-stored/Producto no estocado - Sur stock Europe Zone 1 et Zone 2, nous consulter pour délai d'approvisionnement - E Epuisement/Stock depletion/Agotamiento del stock

Equipement de porte / BUTOIR ECO

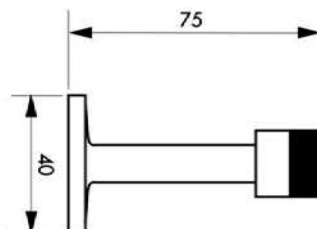

GARANTIE

Description/Description/Descripción

Corps alliage. Embout caoutchouc. Fixation murale
Alloy body. Rubber tip. Wall mounting.
Cuerpo de aleación. Tapa de goma. Para fijación en el pared

Finition/Finish/Acabado

Nickelé satiné
Satin nickel
Niquel satinado

Utilisation/Use/Utilización

Eviter les chocs de la porte contre le mur.
Avoids the shocks door / wall.
Evita los golpes de la puerta contra la pared.

Designation	Boite	Colis.	Prix	Sachet	Colis.	Prix	Brochable					Colis.	Prix
							France	Euro 1	Euro 2	Euro 3	Euro 4		
Butoir balustre 75 mm doré	-	-	-	00900040	30	-	00100040	00193665 NS	00192665 NS	00194665	-	10	-
Butoir balustre 75 mm nickelé satiné	-	-	-	00900041	30	-	-	-	-	-	-	-	

Equipement de porte / BUTOIR PROTECT

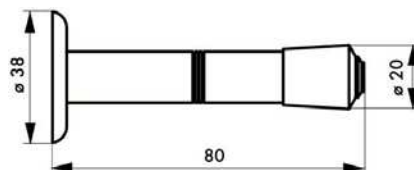

GARANTIE

Description/Description/Descripción

Corps moulé. Bague souple ou caoutchouc.
Moulded body. Flexible or rubber ring.
Cuerpo moldeado - Anillo flexible de caucho.

Finition/Finish/Acabado

Chromé.
Chrome plated
Cromado

Utilisation/Use/Utilización

Eviter les chocs de la porte contre le mur.
Avoids the shocks door / wall.
Evita los golpes de la puerta contra la pared.

Designation	Boite	Colis.	Prix	Sachet	Colis.	Prix	Brochable					Colis.	Prix
							France	Euro 1	Euro 2	Euro 3	Euro 4		
Butoir ballustre long. 80 mm chromé	00000038	10	-	-	-	-	00100038	00193207 NS	-	00194207	-	10	-

NS Non stocké/Non-stored/Producto no estocado - ☑ Sur stock Europe Zone 1 et Zone 2, nous consulter pour délai d'approvisionnement - E Epuisement/Stock depletion/Agotamiento del stock

Equipement de porte / BUTOIR

PROTECT



GARANTIE

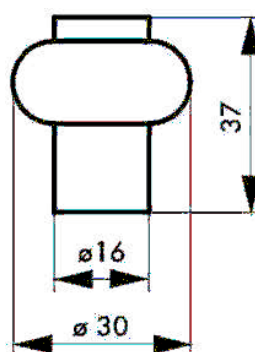
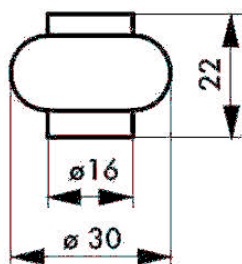

Description/Description/Descripción

Corps moulé. Bague souple ou caoutchouc.
Moulded body. Flexible or rubber ring.
Cuerpo moldeado - Anillo flexible de caucho.

Finition/Finish/Acabado

Laiton. Chromé.
Brass. Chrome plated
Latón. Cromado

Version/Option/Versión

Butoir pour fixation au sol. Butoir à réhausse pour fixation au sol. Vis (4x50) fournie sous conditionnement coque.

Stop for fixing on the wall or on the floor.

Tope balaustre para fijación en la pared. Tope para fijación en el suelo. Tope de realce para fijación en el suelo.

Utilisation/Use/Utilización

Eviter les chocs de la porte contre le mur.
Avoids the shocks door / wall.
Evita los golpes de la puerta contra la pared.

Designation	Boite	Colis.	Prix	Sachet	Colis.	Prix	Brochable					Colis.	Prix
							France	Euro 1	Euro 2	Euro 3	Euro 4		
Butoir de sol Ø 30 mm	00000024	10	-	-	-	-	00100024	00193204 NS	00192204 NS	00194204	-	10	-
Butoir de sol Ø 30 mm chromé	00000022	10	-	-	-	-	00100022	00193205 NS	00192205 NS	00194205	-	10	-
Butoir de sol Ø 30 mm à réhausse	00000023	10	-	-	-	-	00100023	00193206 NS	00192206 NS	00194206	-	10	-
Lot de 2 ButoirS de sol Ø 30 mm	-	-	-	-	-	-	00102024	00193224 NS	-	00194224	-	10	-
Tarif non décollable													
BUTOIR DE SOL Ø 30 mm à réhausse	00010023	100	-	-	-	-	-	-	-	-	-	-	-
BUTOIR DE SOL Ø 30 mm	00010024	100	-	-	-	-	-	-	-	-	-	-	-

NS Non stocké/Non-stored/Producto no estocado - Sur stock Europe Zone 1 et Zone 2, nous consulter pour délai d'approvisionnement - E Epuisement/Stock depletion/Agotamiento del stock

Equipement de porte / BUTOIR PROTECT

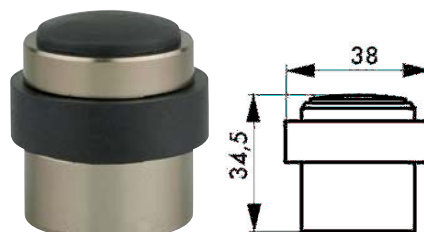

GARANTIE

Description/Description/Descripción

Corps aluminium. Bague caoutchouc.

Aluminium body. Rubber ring.

Cuerpo de aluminio. Anillo de caucho.

Finition/Finish/Acabado

Anodisé argent. Anodisé couleur F2.

Silver anodized. Anodized color F2.

Anodizado plata. Anodizado color F2.

Utilisation/Use/Utilización

Eviter les chocs de la porte contre le mur.

Avoids the shocks door / wall.

Evita los golpes de la puerta contra la pared.

Designation	Boite	Colis.	Prix	Sachet	Colis.	Prix	Brochable					Colis.	Prix
							France	Euro 1	Euro 2	Euro 3	Euro 4		
Butoir de sol Ø 30 mm argent F1	00003047	10	-	-	-	-	00103047	00193316 NS	00192316 NS	00194316	-	10	-
Butoir de sol Ø 30 mm couleur F2	00003048	10	-	-	-	-	00103048	00193317 NS	00192317 NS	00194397	-	10	-
Butoir de sol Ø 30 mm argent	00013046	10	-	00913046	10	-	-	-	-	-	-	-	-

Equipement de porte / BUTOIR PROTECT

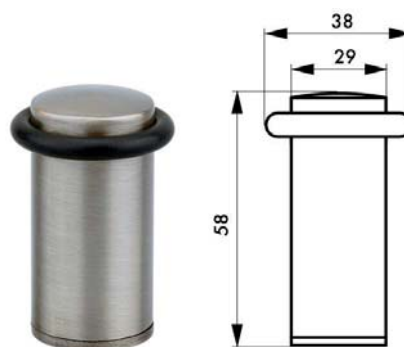
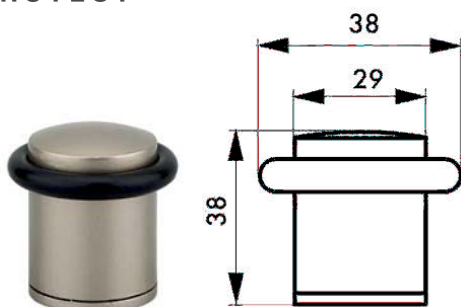

GARANTIE

Description/Description/Descripción

Corps alliage. Bague caoutchouc.

Alloy body. Rubber ring.

Cuerpo de aleación. Anillo de caucho.

Finition/Finish/Acabado

Satiné

Satin finish.

Satnado.

Utilisation/Use/Utilización

Eviter les chocs de la porte contre le mur.

Avoids the shocks door / wall.

Evita los golpes de la puerta contra la pared.

Designation	Boite	Colis.	Prix	Sachet	Colis.	Prix	Brochable					Colis.	Prix
							France	Euro 1	Euro 2	Euro 3	Euro 4		
Butoir de sol Ø 29 mm haut. 38 mm	00013044	10	-	00913044	10	-	-	-	-	-	-	-	-
Butoir de sol Ø 29 mm haut. 58 mm	00013045	10	-	00913045	10	-	-	-	-	-	-	-	-

NS Non stocké/Non-stored/Producto no estocado - S Sur stock Europe Zone 1 et Zone 2, nous consulter pour délai d'approvisionnement - E Epuisement/Stock depletion/Agotamiento del stock

Equipement de porte / BUTOIR RESIST



GARANTIE

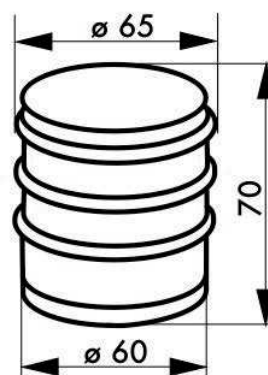
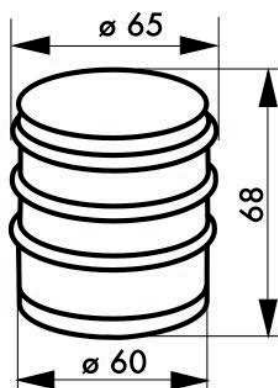
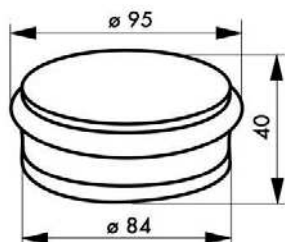

Description/Description/Descripción

Corps acier. Bague souple caoutchouc. A poser.

Steel body. Rubber ring

Cuerpo de acero. Anillo de caucho

Finition/Finish/Acabado

Chromé

Chrome plated

Cromado

Utilisation/Use/Utilización

Pour maintenir la porte en position ouverte

Allows to keep the door open

Permite mantener la puerta en posición abierta

Designation	Boite	Colis.	Prix	Sachet	Colis.	Prix	Brochable					Colis.	Prix
							France	Euro 1	Euro 2	Euro 3	Euro 4		
Butoir de porte 1,3 kg	00091001	1	-	-	-	-	-	-	-	-	-	-	-
Butoir de porte 1,0 kg	00091003	1	-	-	-	-	-	-	-	-	-	-	-
Butoir de porte 1,5 kg	00091004	1	-	-	-	-	-	-	-	-	-	-	-

⊗ Non stocké/Non-stored/Producto no estocado - ⊠ Sur stock Europe Zone 1 et Zone 2, nous consulter pour délai d'approvisionnement - ⊞ Epuisement/Stock depletion/Agotamiento del stock

Equipement de porte / BUTOIR RESIST



GARANTIE

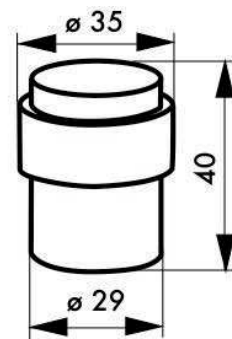
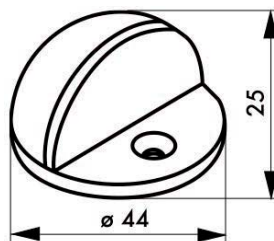
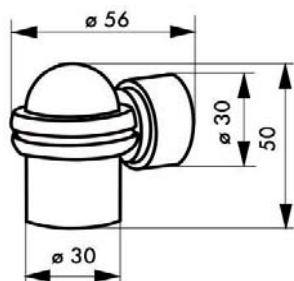

Description/Description/Descripción

Corps aluminium. Bague souple caoutchouc. Fixation au sol.

Aluminium body. Rubber ring. For fixing on the floor.

Cuerpo de aluminio. Anillo de caucho. Para fijación en el suelo.

Finition/Finish/Acabado

Satiné

Nickel plated

Niquel terciopelo

Utilisation/Use/Utilización

Eviter les chocs de la porte contre le mur.

Avoids the shocks door / wall.

Evita los golpes de la puerta contra la pared.

Designation	Boite	Colis.	Prix	Sachet	Colis.	Prix	Brochable					Colis.	Prix
							France	Euro 1	Euro 2	Euro 3	Euro 4		
Butoir de porte avec aimant mural	00091005	10	-	-	-	-	00191005	00193318 NS	00192318 NS	00194318	-	10	-
Butoir de porte demi boule	00091006	10	-	-	-	-	00191006	00193319 NS	00192319 NS	00194319	-	10	-
Butoir de porte inox	00091007	10	-	-	-	-	00191007	193320 NS	00192320 NS	00194320	-	10	-

NS Non stocké/Non-stored/Producto no estocado - ☑ Sur stock Europe Zone 1 et Zone 2, nous consulter pour délai d'approvisionnement - E Epuisement/Stock depletion/Agotamiento del stock

Equipement de porte / BUTOIR RESIST



GARANTIE

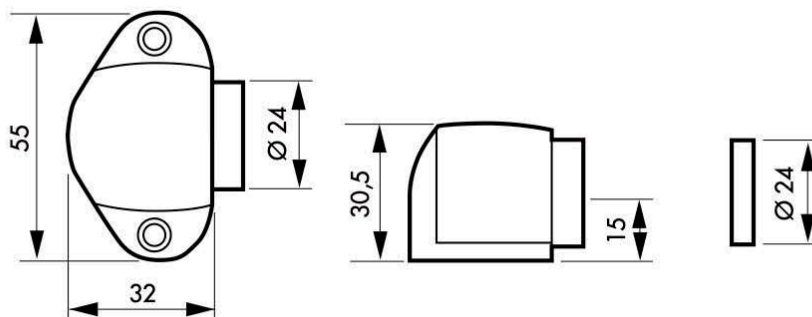

Description/Description/Descripción

Corps inox 304. Avec aimant intégré. Fixation au sol, 2 points de fixation.

304 Stainless steel body. With integrated magnet. Floor mounting, 2 fixing points.

Cuerpo de acero inoxidable 304. Con imán integrado. Para fijación en el suelo, 2 puntos de fijación.

Finition/Finish/Acabado

Inox brossé.

Brushed stainless steel.

Acero inoxidable cepillado

Utilisation/Use/Utilización

Eviter les chocs de la porte contre le mur.

Avoids the shocks door / wall.

Evita los golpes de la puerta contra la pared.

Designation	Boite	Colis.	Prix	Sachet	Colis.	Prix	Brochable					Colis.	Prix
							France	Euro 1	Euro 2	Euro 3	Euro 4		
BUTOIR de porte avec aimant mural - inox brossé	-	-	-	00991014	10	-	00191014	00193605 NS	00192605 NS	00194605	-	10	-

NS Non stocké/Non-stored/Producto no estocado - Sur stock Europe Zone 1 et Zone 2, nous consulter pour délai d'approvisionnement - E Epuisement/Stock depletion/Agotamiento del stock

Equipement de porte / BUTOIR RESIST



GARANTIE

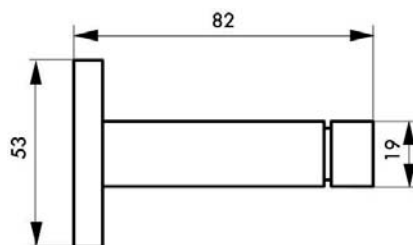

Description/Description/Descripción

Corps inox. Embout caoutchouc. Fixation au mur.
Stainless steel body. Rubber end. For fixing on the wall.
Cuerpo de acero inoxidable. Punta de caucho. Para fijación en el pared.

Finition/Finish/Acabado

Inox brossé
Brushed stainless steel
Inoxidable cepillado

Utilisation/Use/Utilización

Eviter les chocs de la porte contre le mur.
Avoids the shocks door / wall.
Evita los golpes de la puerta contra la pared.

Designation	Boite	Colis.	Prix	Sachet	Colis.	Prix	Brochable					Colis.	Prix
							France	Euro 1	Euro 2	Euro 3	Euro 4		
Butoir balustre Inox longueur 85mm	00000032	10	-	00900032	10	-	-	-	-	-	-	-	-

Equipement de porte / BUTOIR RESIST



GARANTIE

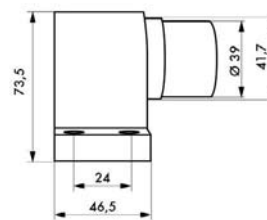
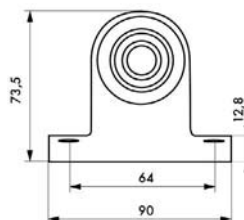

Description/Description/Descripción

Corps inox. Embout caoutchouc avec amortisseur.
Fixation au sol.
Stainless steel body. Rubber end with shock absorber. For fixing on the floor.
Cuerpo de acero inoxidable. Punta de caucho con amortiguador. Para fijación en el suelo.

Finition/Finish/Acabado

Inox brossé
Brushed stainless steel
Inoxidable cepillado

Utilisation/Use/Utilización

Pour porte lourde
For heavy door
Para puerta pesada.

Designation	Boite	Colis.	Prix	Sachet	Colis.	Prix	Brochable					Colis.	Prix
							France	Euro 1	Euro 2	Euro 3	Euro 4		
Butoir renforcé inox	00091009	10	-	-	-	-	-	-	-	-	-	-	-

Equipement de fenêtre / ENTREBÂILLEUR ECO



GARANTIE

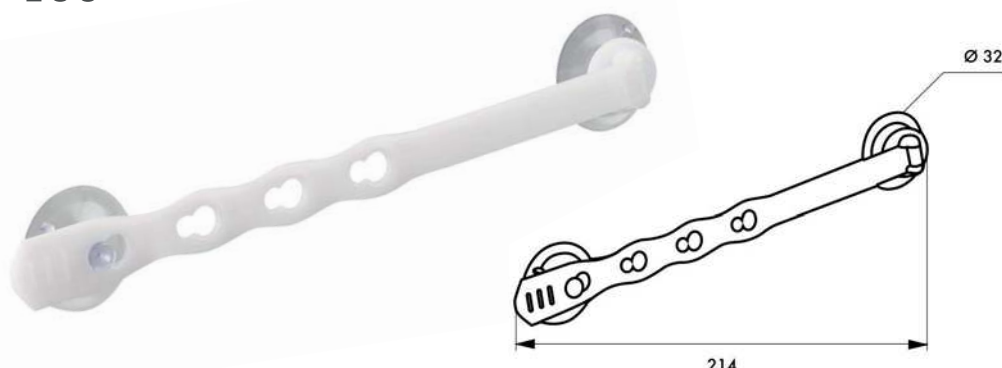

Description/Description/Descripción

PVC. Fixation à ventouse repositionnable. 4 positions réglables. Livré avec pastilles adhésives pour adaptation sur supports non lisses.

PVC. Fitted with repositionable suction mounts. 4 positions. Delivered with adhesive mounts for uneven surfaces.

PVC. Fijación con ventosa repositionable. 4 posiciones ajustables. Se entrega con pastillas adhesivas para adaptación a soportes que no sean lisos.

Finition/Finish/Acabado

Blanc

White

Blanco

Utilisation/Use/Utilización

Entrebaillage de fenêtre à 1 ou 2 vantaux

Fastening for window 1 or 2 leaves

Entreapertura de ventanas 1 ó 2 batientes

Designation	Boite	Colis.	Prix	Sachet	Colis.	Prix	Brochable					Colis.	Prix
							France	Euro 1	Euro 2	Euro 3	Euro 4		
ENTREBAILLEUR DE FENETRE A VENTOUSE	-	-	-	-	-	-	00428020	-	-	-	-	10	-

Equipement de fenêtre / ENTREBÂILLEUR PROTECT



GARANTIE

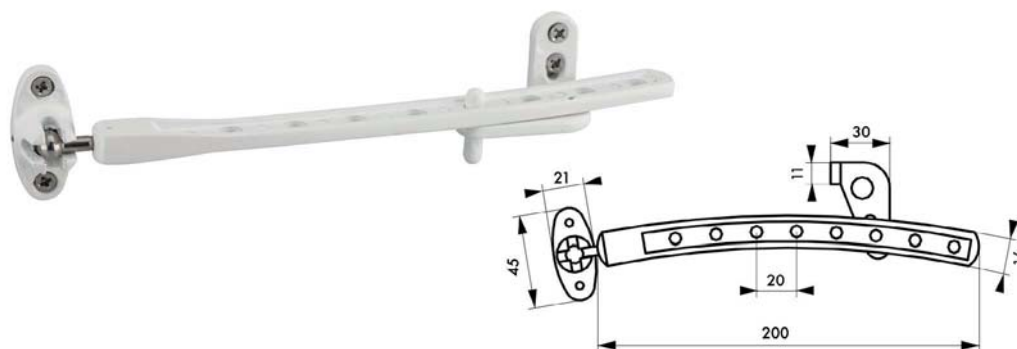

Description/Description/Descripción

Corps alliage moulé. 8 positions d'entrebaillage.

Taquet d'arrêt pouvant être posé à droite ou à gauche.

Sécurité enfant : peut se cadenasser avec un cadenas de 30 mm.

Moulded alloy body. 8 fastening positions. Catch to be fitted on right or left hand side. Can be locked by padlock 30 mm.

Cuerpo de aleación moldeada. 8 posiciones de retención.

Tope de retén que puede montarse a la derecha o a la izquierda. Se puede bloquear con candado de 30 mm.

Finition/Finish/Acabado

Laqué blanc

White lacquered

Lacado blanco

Utilisation/Use/Utilización

Entrebaillage de fenêtre à 1 ou 2 vantaux

Fastening for window 1 or 2 leaves

Entreapertura de ventanas 1 ó 2 batientes

Designation	Boite	Colis.	Prix	Sachet	Colis.	Prix	Brochable					Colis.	Prix
							France	Euro 1	Euro 2	Euro 3	Euro 4		
ENTREBAILLEUR DE FENETRE laqué blanc	-	-	-	00900402	10	-	00400402	00493089	00492089	00494089	-	10	-

Ⓜ Non stocké/Non-stored/Producto no estocado - Ⓜ Sur stock Europe Zone 1 et Zone 2, nous consulter pour délai d'approvisionnement - Ⓜ Epuement/Stock depletion/Agotamiento del stock

Équipement de fenêtre / ENTREBÂILLEUR PROTECT



Entrebailleurs de fenêtres PVC adaptable pour les fenêtres à 1 ou 2 vantaux.



GARANTIE

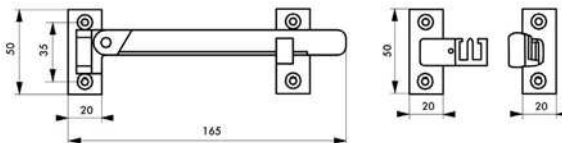

Description/Description/Descripción

Éléments en polyamide chargé verre. 14 positions d'entrebaillement. Peut se fixer sans percer avec l'adhésif fourni.

Fibre glass reinforced polyamid parts. 14 fastening positions. Apply to PVC and aluminium without drilling, using the supplied adhesive.

Elementos de poliamida, cargada de vidrio. 14 posiciones de retención. Se puede fijar sin taladrar, con el adhesivo suministrado.

Finition/Finish/Acabado

PVC blanc. Ton bois - Translucide

White PVC - Wooden finish

PVC blanco - PVC madera

Utilisation/Use/Utilización

Entrebaillage de fenêtre, porte fenêtre : Bois, PVC, aluminium.

Fastening of wooden, PVC and aluminium windows and doors windows.

Entreapertura de ventana, puertaventana madera, PVC, aluminio.

Designation	Boite	Colis.	Prix	Sachet	Colis.	Prix	Brochable					Colis.	Prix
							France	Euro 1	Euro 2	Euro 3	Euro 4		
ENTREBAILLEUR DE FENETRE 1 ou 2 vantaux blanc	-	-	-	00900401	10	-	00200401	-	-	00294208	-	10	-
ENTREBAILLEUR DE FENETRE 1 ou 2 vantaux ton bois	-	-	-	-	-	-	00201401	-	-	00294248	-	10	-
ENTREBAILLEUR DE FENETRE 1 ou 2 vantaux translucide	-	-	-	-	-	-	00201402	-	-	-	-	10	-

Équipement de fenêtre / ENTREBÂILLEUR PROTECT

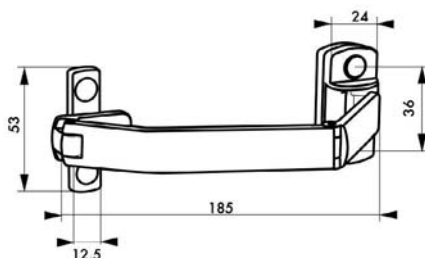

GARANTIE

Description/Description/Descripción

Alliage. Pour fenêtre coulissante. Incrochetable de l'extérieur.

Alloy. For sliding windows. Cannot be picked from the outside.

Aleación. Para ventana deslizante. No se puede forzar desde el exterior.

Finition/Finish/Acabado

Blanc / White / Blanco

Utilisation/Use/Utilización

Entrebaillage de baie coulissante

Safety retainer for sliding windows

Puertas y ventanas correderas.

Designation	Boite	Colis.	Prix	Sachet	Colis.	Prix	Brochable					Colis.	Prix
							France	Euro 1	Euro 2	Euro 3	Euro 4		
ENTREBAILLEUR BAIE COULISSANTE	-	-	-	-	-	-	00428015	-	-	-	-	10	-

⚠ Non stocké/Non-stored/Producto no estocado - ⚠ Sur stock Europe Zone 1 et Zone 2, nous consulter pour délai d'approvisionnement - ⚠ Epuisement/Stock depletion/Agotamiento del stock

Equipement de fenêtre / ENTREBÂILLEUR RESIST

Entrebailleurs de fenêtres adaptable
pour les fenêtres à 1 ou 2 vantaux.



GARANTIE

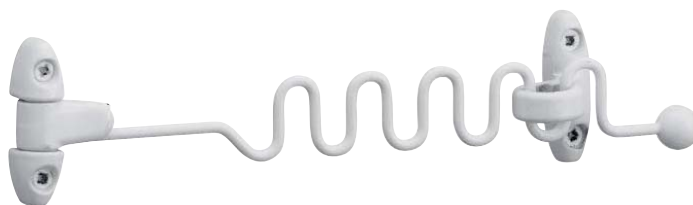
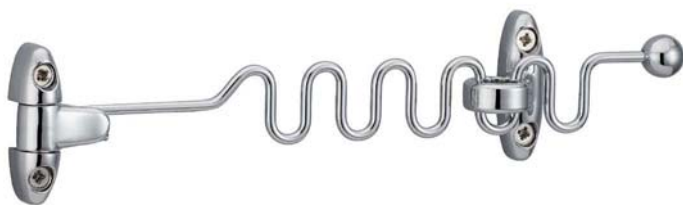

4 positions
d'entrebaillement

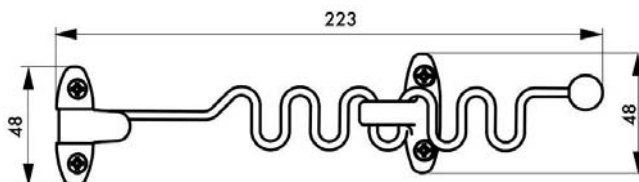

Description/Description/Descripción

Corps acier. Platine alliage. 4 positions d'entrebaillement.
Sécurité enfant : peut se cadenasser avec un cadenas de 30 mm.

Steel body. Plate made of moulded alloy. 4 fastening positions. Can be locked by padlock 30 mm.

Cuerpo de acero. Pletina aleado moldeado. 4 posiciones de retención. Se puede bloquear con candado de 30 mm.

Finition/Finish/Acabado

Chromé, doré ou laqué blanc
Chrome, gold plated or white lacquered
Cromado, dorado o lacado blanco

Utilisation/Use/Utilización

Entrebaillage de fenêtres, volets, persiennes à 1 ou 2 vantaux.

Fastening for windows, venetian shutters.

Entreapertura de ventanas, contraventanas y persianas.

Designation	Boite	Colis.	Prix	Sachet	Colis.	Prix	Brochable					Colis.	Prix
							France	Euro 1	Euro 2	Euro 3	Euro 4		
ENTREBAILLEUR DE FENETRE à 1 ou 2 vantaux chromé	-	-	-	00900406	10	-	00400406	00493209 NS	00492209 NS	00494209	-	10	-
ENTREBAILLEUR DE FENETRE à 1 ou 2 vantaux doré	-	-	-	00900407	10	-	00400407	00493210 NS	00492210 NS	00494210	-	10	-
ENTREBAILLEUR DE FENETRE à 1 ou 2 vantaux laqué blanc	-	-	-	00901408	10	-	00400408	00493211 NS	00492211 NS	00494211	-	10	-

NS Non stocké/Non-stored/Producto no estocado - Sur stock Europe Zone 1 et Zone 2, nous consulter pour délai d'approvisionnement - E Epuisement/Stock depletion/Agotamiento del stock

Équipement de fenêtre / ENTREBÂILLEUR PROTECT



GARANTIE



X 1

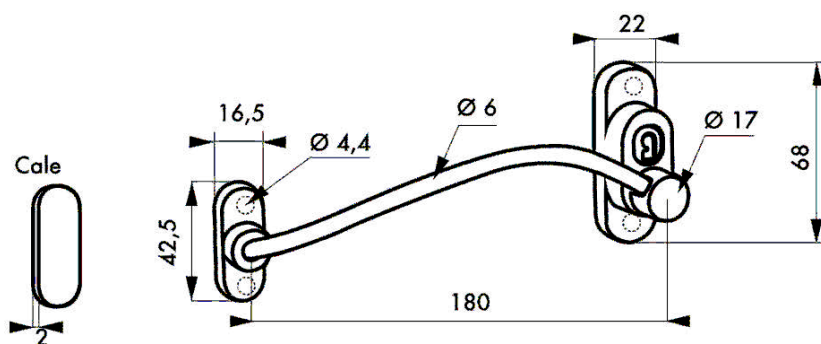

Description/Description/Descripción

Câble acier gainé. 1 clé.
Steel sheathed cable. 1 key.
Cable de acero con revestimiento. 1 llave.

Finition/Finish/Acabado

Laqué blanc
White lacquered
Lacado blanco

Utilisation/Use/Utilización

Pour fenêtre
For window.
Para ventana.

Designation	Boite	Colis.	Prix	Sachet	Colis.	Prix	Brochable					Colis.	Prix
							France	Euro 1	Euro 2	Euro 3	Euro 4		
ENTREBAILLEUR DE FENETRE A CÂBLE	-	-	-	00900411	10	-	00200411	00293801 NS	00292801 NS	00294801	-	10	-

NS Non stocké/Non-stored/Producto no estocado - ☑ Sur stock Europe Zone 1 et Zone 2, nous consulter pour délai d'approvisionnement - E Epusement/Stock depletion/Agotamiento del stock

Equipement de fenêtre / ENTREBÂILLEUR RESIST

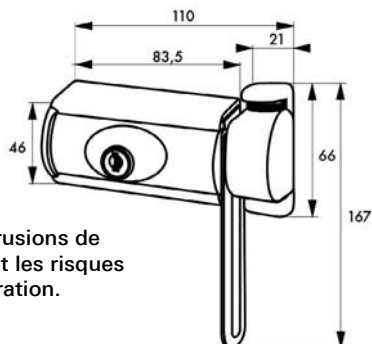

Evitez les intrusions de l'extérieur, et les risques de défenestration.



GARANTIE

Description/Description/Descripción

Corps alliage moulé. Pêne acier. Gâche entrebailleur. 6 positions d'entrebaillement. Mécanisme à 7 goupilles. 2 clés.

Moulded alloy body. Steel bolt. Strike to slightly open the window. 6 opening positions. Mechanism with 7 pins. 2 keys. Surface fitting to 1-pane window, pivoted window or not.

Cuerpo de aleación moldeado. Pestillo de acero.

Cerradero retenedor. 6 posiciones de retención.

Mecanismo de 7 pasadores. 2 llaves. Colocación en applique en ventana con 1 hoja, oscilobattante ou no.

Finition/Finish/Acabado

Laqué blanc

White lacquered

Lacado blanco

Utilisation/Use/Utilización

Pose en applique sur fenêtré à 1 vantail, oscillo battant ou non.

Fixing on wooden window.

Montage en plastron en ventananas de madera con durmiente en saliente.

Designation	Boite	Colis.	Prix	Sachet	Colis.	Prix	Brochable					Colis.	Prix
							France	Euro 1	Euro 2	Euro 3	Euro 4		
ENTREBAILLEUR FENETRE a clé	-	-	-	-	-	-	00328017	-	-	-	-	10	-

Equipement de fenêtré / ENTREBÂILLEUR RESIST



A clé : Evitez les risques de défenestration, idéal pour les écoles, hôpitaux ...

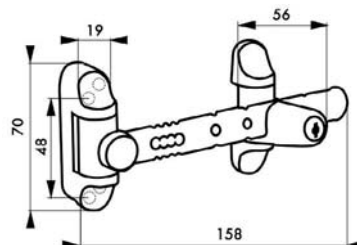

GARANTIE

Description/Description/Descripción

Corps alliage. Position réglable. 2 cales d'ajustement épaisseur 6 et 12 mm. Cylindre à paillettes, 2 clés.

Alloy body. Adjustable position. 2 adjustment stops, 6 and 12 mm thick. Disc tumbler cylinder. 2 keys.

Cuerpo de aleación. Posición ajustable. 2 cuñas de ajuste de grosor 6 y 12 mm. Cilindro de plaquitas, 2 llaves.

Finition/Finish/Acabado

Laqué blanc

White lacquered

Lacado blanco

Version/Option/Versión

Verrouillage par bouton poussoir.

Locked with a push-button.

Bloqueo mediante botón pulsador.

Utilisation/Use/Utilización

Pour fenêtré ouvrant à la française, 1 ou 2 vantaux

For casement window, 1 or 2 panes.

Para ventana con apertura francesa, 1 o 2 hojas



X 2

Designation	Boite	Colis.	Prix	Sachet	Colis.	Prix	Brochable					Colis.	Prix
							France	Euro 1	Euro 2	Euro 3	Euro 4		
ENTREBAILLEUR FENETRE 1 / 2 Vantaux - 2 clés	-	-	-	-	-	-	00428019	-	-	-	-	10	-
ENTREBAILLEUR FENETRE 1 / 2 Vantaux - à bouton poussoir	-	-	-	-	-	-	00428018	-	-	-	-	10	-

Equipement de fenêtre / ENTREBÂILLEUR RESIST



GARANTIE



X 3



Rendez vos fenêtres compatibles avec vos installations sur passe.

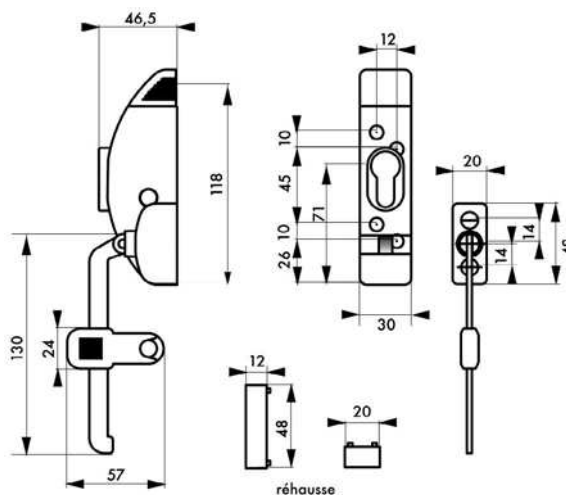

Description/Description/Descripción

Corps alliage moulé. Pêne acier nickelé. Bras acier nickel satin. Réhausse pour fenêtre à recouvrement. Verrouillage possible de l'entrebaillement.

Moulded alloy body. Nickel plated steel bolt. Possible adjustment of the fastening.

Cuerpo de aleación moldeado. Pestillo de acero niquelado. Posibilidad de ajuste del retenedor.

Finition/Finish/Acabado

Blanc, argent
White, silver
Blanco, plata

Version/Option/Versión

Avec 1/2 cylindre profilé européen pour verrouillage, 3 clés.

Locking with 1/2 european profile. cylinder, 3 keys.

Condensación con 1/2 cilindro perfilado, 3 llaves.

Utilisation/Use/Utilización

Entrebaillage pour tous types de fenêtres et porte-fenêtres.

Locking in the closed or ventilation position of all types of windows.

Retenedor para todo tipo de ventanas y de puertaventanas.

Designation	Boite	Colis.	Prix	Sachet	Colis.	Prix	Brochable					Colis.	Prix
							France	Euro 1	Euro 2	Euro 3	Euro 4		
Entrebaillage de fenêtre blanc à cylindre profilé 3 clés	00061411	1	-	-	-	-	00361411	-	-	-	-	5	-
Entrebaillage de fenêtre argent à cylindre profilé 3 clés	00061413	1	-	-	-	-	00361413	-	-	-	-	5	-
Boitier entrebaillage de fenêtre blanc sans cylindre	00061401	1	-	-	-	-	-	-	-	-	-	-	-
Boitier entrebaillage de fenêtre argent sans cylindre	00061403	1	-	-	-	-	-	-	-	-	-	-	-

⚠ Non stocké/Non-stored/Producto no estocado - 📦 Sur stock Europe Zone 1 et Zone 2, nous consulter pour délai d'approvisionnement - 🇪🇺 Epuisement/Stock depletion/Agotamiento del stock

Équipement de volets / VOLET ROULANT PROTECT



GARANTIE



X 1



Mécanisme anti-soulèvement
pour verrouiller automatiquement
les volets roulants

Description/Description/Descripción

Acier inoxydable 18/10

Stainless steel 18/10

Acero inoxidable 18/10

Finition/Finish/Acabado

Acier

Steel

Acero

Utilisation/Use/Utilización

Pour volets roulants

For roller shutter

Para persiana enrollable

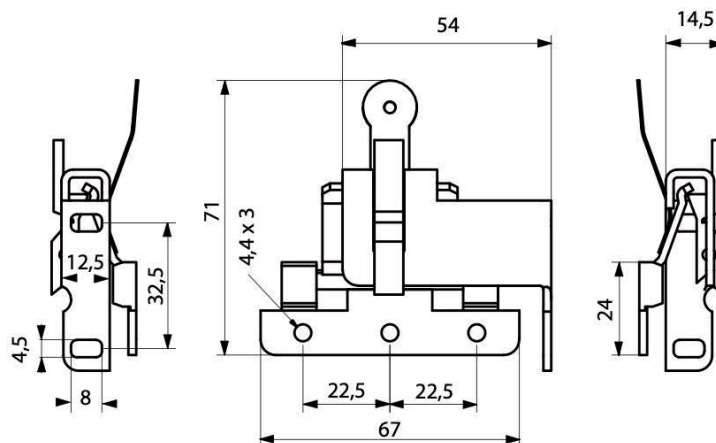

Designation	Boîte	Colis.	Prix	Sachet	Colis.	Prix	Brochable					Colis.	Prix
							France	Euro 1	Euro 2	Euro 3	Euro 4		
FERME VOLET ROULANT inox (2 pièces)	-	-	-	00900439	10	-	00200439	-	-	-	-	5	-

Non stocké/Non-stored/Producto no estocado - Sur stock Europe Zone 1 et Zone 2, nous consulter pour délai d'approvisionnement - Epuement/Stock depletion/Agotamiento del stock

Equipement de volets / BARRE

PROTECT

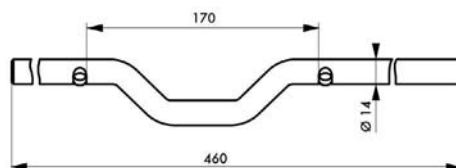
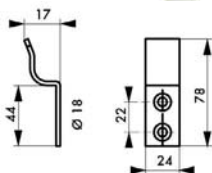

GARANTIE

Description/Description/Descripción

Barre acier Ø 14 mm. 4 pattes anti-crochetage. Vis à bois
Steel bar Ø 14 mm. 4 anti-picking fastenings. Head square
neck bolts fixing.

Barra de acero Ø 14 mm. 4 patillas inviolables. Perno con
cabeza collarín cuadrado.

Finition/Finish/Acabado

Zingué. Zingué noir.

Bichromated. Black zinc plated.

Cincado bicromatado. Cincado negro.

Utilisation/Use/Utilización

Pour volets bois.

For wooden shutters.

Para contraventanas de madera.

Designation	Boite	Colis.	Prix	Sachet	Colis.	Prix	Brochable					Colis.	Prix
							France	Euro 1	Euro 2	Euro 3	Euro 4		
BARRE 0,46 m non cadenassable zingué	-	-	-	-	-	-	00707901	-	00792088	00794088	-	10	-
BARRE 0,46 m non cadenassable zingué noir	-	-	-	-	-	-	00707911	-	-	-	-	10	-

Equipement de volets / BARRE

RESIST

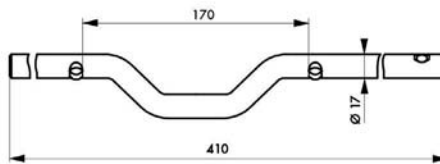
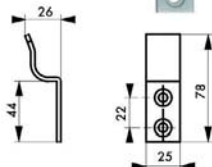

GARANTIE

Description/Description/Descripción

Barre acier Ø 18 mm. 4 pattes anti-crochetage. Boulon
à tête collet Carré. Possibilité de verrouillage de la barre
par cadenas.

Steel bar Ø 18 mm. 4 anti-picking fastenings. Head
square neck bolts fixing. It's possible to lock the bar with
a padlock.

Barra de acero Ø 18 mm. 4 patillas inviolables. Perno con
cabeza collarín cuadrado. Posibilidad de bloqueo de la
barra con candado.

Finition/Finish/Acabado

Zingué. Zingué noir. / Bichromated. Black zinc plated.

Cincado bicromatado. Cincado negro.

Version/Option/Versión

Verrouillable par cadenas / Locking by padlock

Bloqueo candado

Utilisation/Use/Utilización

Pour volets bois. / For wooden shutters.

Para contraventanas de madera.

Designation	Boite	Colis.	Prix	Sachet	Colis.	Prix	Brochable					Colis.	Prix
							France	Euro 1	Euro 2	Euro 3	Euro 4		
BARRE 0,41 m zingué	-	-	-	-	-	-	00708901	-	00792093	00794093	-	10	-
BARRE 0,41 m zingué noir	-	-	-	-	-	-	00708911	-	-	-	-	10	-
BARRE 0,80 m zingué noir	00008913	1	-	-	-	-	-	-	-	-	-	-	-

Non stocké/Non-stored/Producto no estocado - Sur stock Europe Zone 1 et Zone 2, nous consulter pour délai d'approvisionnement - Epuisement/Stock depletion/Agotamiento del stock

Equipped de volets / DOUBLE BARRE DE SÉCURITÉ RESIST



GARANTIE

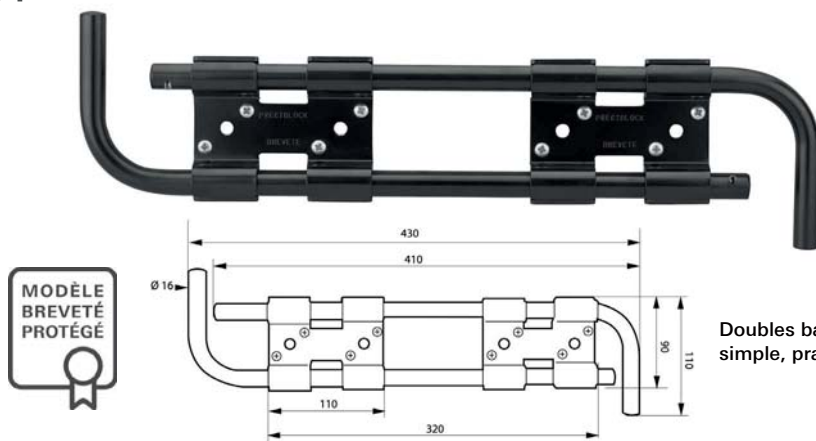

Doubles barres de sécurité : simple, pratique et efficace.

Description/Description/Descripción

Tubes acier Ø 16 mm avec goupilles darrêt. Fixation par 4 vis TRCC M8x50 indévissable de l'extérieur + 8 vis à bois (visserie fournie). Tube à demeure sur le volet avec goupille empêchant de le sortir de la glissière. Montage rapide.

16 mm steel tubes with locking pins. Fixing with 4 TRCC M8x50 screws that cannot be removed from the outside + 8 wood screws (screws supplied). Tube permanently to the with pin preventing it from coming out of the slide. Quick assembly.

Tubos de acero de Ø 16 mm con pasadores de bloqueo. Fijación con 4 tornillos TRCC M8x50 que no se pueden quitar del exterior + 8 tornillos para madera (tornillos suministrados). Tubo permanentemente a la aleta con un pasador que evita que salga del portaobjetos Montaje rápido.

Finition/Finish/Acabado

Noir. / Black. / Negro.

Utilisation/Use/Utilización

Pour volets bois avec barre ou écharpe en Z

For wooden shutters

Para contraventanas de madera

Designation	Boite	Colis.	Prix	Sachet	Colis.	Prix	Brochable					Colis.	Prix
							France	Euro 1	Euro 2	Euro 3	Euro 4		
Double barre de sécurité pour volets	-	-	-	00909911	1	-	-	-	-	-	-	-	-

Equipped de porte / ARRÊT PROTECT



GARANTIE

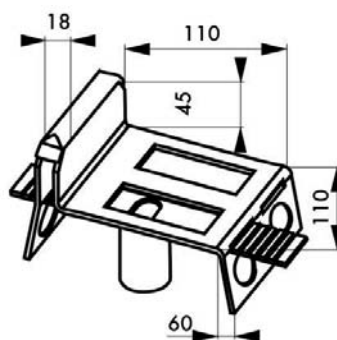

Description/Description/Descripción

Acier épaisseur 25/10ème. Glissière de réglage.

25/10ème steel. Sliding adjustment.

25/10ème acero.

Finition/Finish/Acabado

Zingué / Zinc plated / Cincado

Utilisation/Use/Utilización

Sabot à sceller.

Embedded shoe.

Bloqueo de portal en posición entreabierto.

Designation	Boite	Colis.	Prix	Sachet	Colis.	Prix	Brochable					Colis.	Prix
							France	Euro 1	Euro 2	Euro 3	Euro 4		
Sabot à sceller avec glissière réglage	00011131	1	-	-	-	-	-	-	-	-	-	-	

Non stocké/Non-stored/Producto no estocado - Sur stock Europe Zone 1 et Zone 2, nous consulter pour délai d'approvisionnement - Epuiseiment/Stock depletion/Agotamiento del stock

Equipement de porte / ARRÊT PROTECT

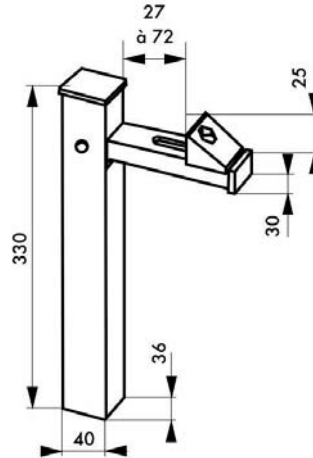

GARANTIE

Description/Description/Descripción

Profil aluminium. Ressort inox. Rivet laiton.
Aluminium profile. Stainless steel spring. Brass rivet.
Perfil de aluminio. Resorte de acero inoxidable. Remache de latón.

Finition/Finish/Acabado

Anodisé argent. / Silver anodized. / Anodizado plata.

Utilisation/Use/Utilización

Arrêt de portail à sceller. / Garden gate stop.
Deje de portal para sellar.

Designation	Boite	Colis.	Prix	Sachet	Colis.	Prix	Brochable					Colis.	Prix
							France	Euro 1	Euro 2	Euro 3	Euro 4		
Arrêt de portail vertical aluminium anodisé	00031001	1	-	-	-	-	-	-	-	-	-	-	-

Equipement de porte / ARRÊT RESIST

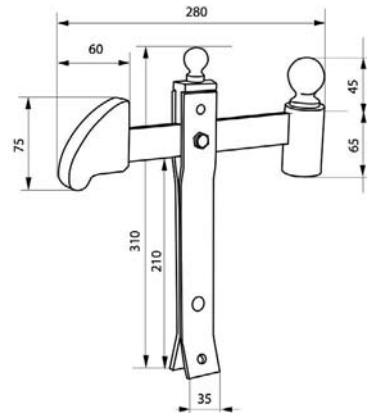

GARANTIE

Description/Description/Descripción

Fonte d'acier. À bascule.
Cast steel. Rocking.
Acero fundido. Balanceo.

Finition/Finish/Acabado

Noir 9005. / Black. / Negro.

Utilisation/Use/Utilización

Arrêt de portail à sceller.
Garden gate stop.
Deje de portal para sellar.

Designation	Boite	Colis.	Prix	Sachet	Colis.	Prix	Brochable					Colis.	Prix
							France	Euro 1	Euro 2	Euro 3	Euro 4		
Arrêt de grille/portail noir à bascule	-	-	-	00931006	1	-	-	-	-	-	-	-	-

⚠ Non stocké/Non-stored/Producto no estocado - 📦 Sur stock Europe Zone 1 et Zone 2, nous consulter pour délai d'approvisionnement - 📦 Epuisement/Stock depletion/Agotamiento del stock

Protection de la personne

ECO

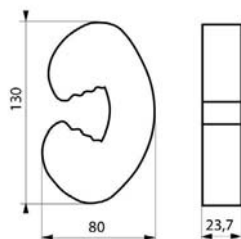

GARANTIE

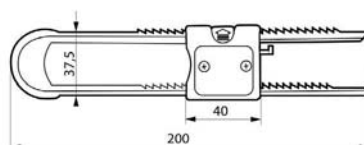
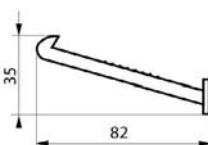
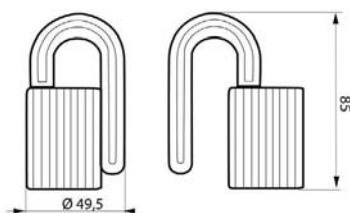
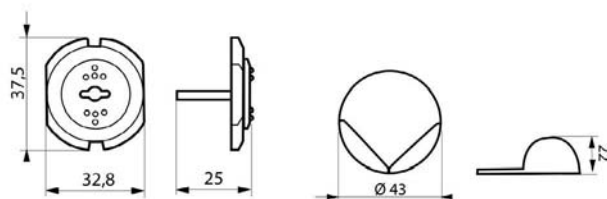

Description/Description/Descripción

Amortisseur de porte anti-pince doigt. Cache prise.
 Bloque porte de meuble. Bloque tiroir. Protège coin de table.
 Entrebailleur bloque charnière.
*Shock door fingersafe. Socket guards. Multi purpose lock.
 Drawer safety latch. Corner table protector. Door Guards hinge blocks.*
 Amortiguadores para puertas. Protectores de enchufes.
 Cerraduras de la puerta. Bloque de cajón. Protección rincón de mesa. Retenedor de seguridad.

Finition/Finish/Acabado

Blanc
 White
 Blanco

Utilisation/Use/Utilización

Sécurité enfant
 Child safety
 Seguridad para niños

Designation	Boite	Colis.	Prix	Sachet	Colis.	Prix	Brochable					Colis.	Prix
							France	Euro 1	Euro 2	Euro 3	Euro 4		
Amortisseur de porte anti-pince doigt, 2 pièces	-	-	-	-	-	-	00101101 E	00101101 E	00101101 E	00101101 E	-	10	-
Cache prise, blanc, 12 pièces	-	-	-	-	-	-	00101102 E	00101102 E	00101102 E	00101102 E	-	10	-
Bloque porte de meuble, blanc, 1 pièce	-	-	-	-	-	-	00201103	00201103	00201103	00201103	-	10	-
Bloque tiroir, blanc, 4 pièces	-	-	-	-	-	-	00101104	00101104	00101104	00101104	-	10	-
Protège coin table, 4 pièces	-	-	-	-	-	-	00101105	00101105	00101105	00101105	-	10	-
Entrebailleur bloque charnière, blanc, 2 pièces	-	-	-	-	-	-	00101106	00101106	00101106	00101106	-	10	-

Non stocké/Non-stored/Producto no estocado - Sur stock Europe Zone 1 et Zone 2, nous consulter pour délai d'approvisionnement - E Epuisement/Stock depletion/Agotamiento del stock

Équipement / POIGNÉE DE MALLE ECO



Max 120 kg

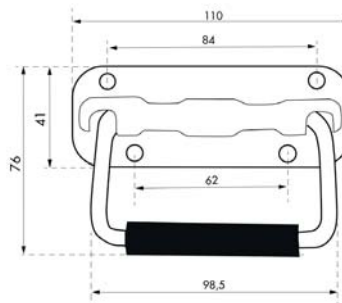

GARANTIE

Description/Description/Descripción

Acier. Avec ressort de renvoi. Prise en main PVC noir.
Steel. With spring. Handle with black PVC. Acero.
Acero. Con primavera. Manejar con PVC negro.

Finition/Finish/Acabado

Chromé. / Chrome plated / Cromado

Utilisation/Use/Utilización

Poignée pour malle.
Handle for trunk.
Asa para maleta.

Designation	Boite	Colis.	Prix	Sachet	Colis.	Prix	Brochable					Colis.	Prix
							France	Euro 1	Euro 2	Euro 3	Euro 4		
POIGNÉE de malle avec ressort de renvoi	-	-	-	00930186	10	-	-	-	-	-	-	-	-

Équipement / POIGNÉE DE MALLE ECO



Max 150 kg

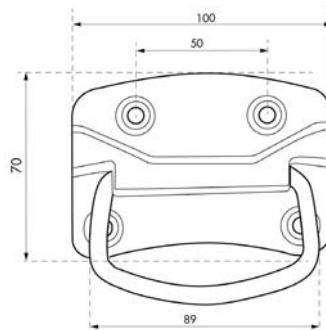

GARANTIE

Description/Description/Descripción

Acier.
Steel.
Acero.

Finition/Finish/Acabado

Zinguée / Zinc plated / Cincado

Utilisation/Use/Utilización

Poignée pour malle.
Handle for trunk.
Asa para maleta.

Designation	Boite	Colis.	Prix	Sachet	Colis.	Prix	Brochable					Colis.	Prix
							France	Euro 1	Euro 2	Euro 3	Euro 4		
POIGNÉE DE MALLE	-	-	-	00930187	10	-	-	-	-	-	-	-	-

Équipement / SAUTERELLE À LEVIER

PROTECT



GARANTIE

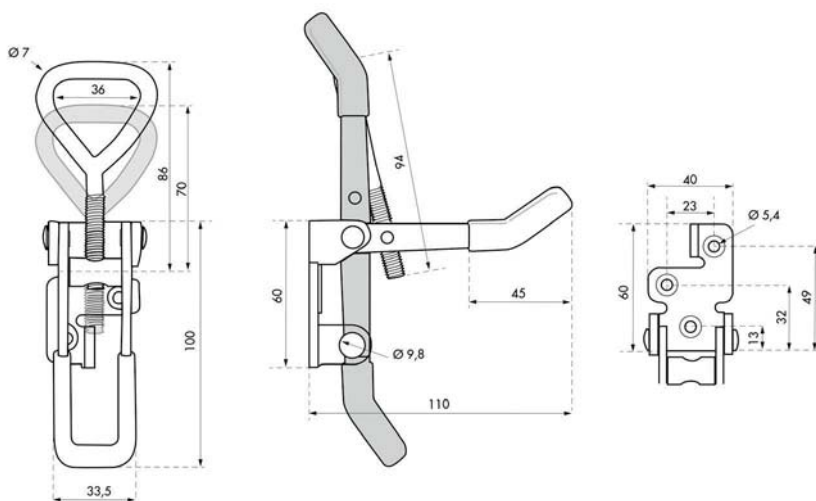

Description/Description/Descripción

Acier. Poignée gainée Cadenassable.

Steel. Handle PVC sheathed. Can be locked by padlock.

Acero. Manija cubierta de pvc. Se puede bloquear con candado.

Finition/Finish/Acabado

Zinguée

Zinc plated

Cincado

Designation	Boite	Colis.	Prix	Sachet	Colis.	Prix	Brochable					Colis.	Prix
							France	Euro 1	Euro 2	Euro 3	Euro 4		
SAUTERELLE à levier	-	-	-	00930185	10	-	-	-	-	-	-	-	-

⊗ Non stocké/Non-stored/Producto no estocado - ⊠ Sur stock Europe Zone 1 et Zone 2, nous consulter pour délai d'approvisionnement - ⊞ Epuisement/Stock depletion/Agotamiento del stock



Équipement / FERMETURE à LEVIER

ECO



00930180

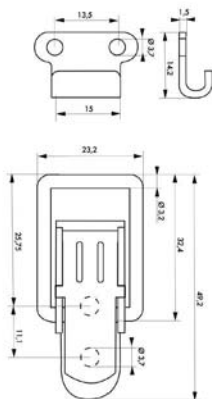

00930181

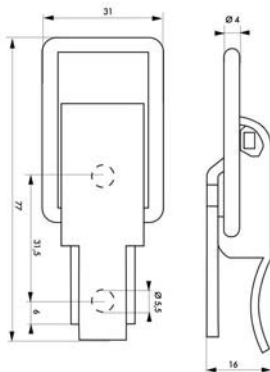

00930184

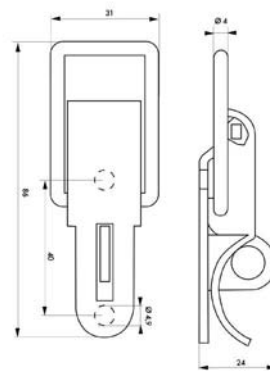

GARANTIE

Description/Description/Descripción

Acier, avec crochet. (ref. 930183 : inox)

Steel, with hook. (ref. 930183 : stainless steel)

Acero, con gancho. (ref. 930183 acero inoxidable)

Finition/Finish/Acabado

Zingué.

Zinc plated.

Cincado.



00930182



00930183

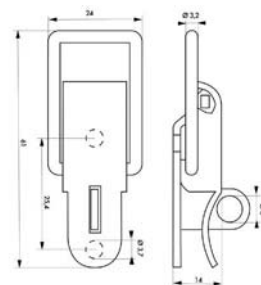
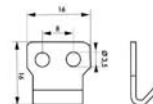

Designation	Boite	Colis.	Prix	Sachet	Colis.	Prix	Brochable					Colis.	Prix
							France	Euro 1	Euro 2	Euro 3	Euro 4		
Fermeture à levier hauteur 36 mm	-	-	-	00930180	10	-	-	-	-	-	-	-	-
Fermeture à levier hauteur 70 mm	-	-	-	00930181	10	-	-	-	-	-	-	-	-
Fermeture à levier cadenassable hauteur 54 mm	-	-	-	00930182	10	-	-	-	-	-	-	-	-
Fermeture à levier cadenassable hauteur 84 mm	-	-	-	00930184	10	-	-	-	-	-	-	-	-
Fermeture à levier inox cadenassable hauteur 54 mm	-	-	-	00930183	10	-	-	-	-	-	-	-	-

NS Non stocké/Non-stored/Producto no estocado - S Sur stock Europe Zone 1 et Zone 2, nous consulter pour délai d'approvisionnement - E Epuisement/Stock depletion/Agotamiento del stock

Equipement de porte / FERMETURE à LEVIER

PROTECT



GARANTIE



Description/Description/Descripción

Acier, avec crochet.

Steel, with hook.

Acero, con gancho.

Finition/Finish/Acabado

Zingué.

Zinc plated.

Cincado.

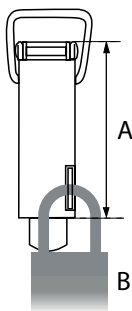

	A	B
930170	44	Sans cadenas
930173	44	Cadenassable
930171	70	Sans cadenas
930174	70	Cadenassable
930172	90	Sans cadenas
930175	90	Cadenassable

Designation	Boite	Colis.	Prix	Sachet	Colis.	Prix	Brochable					Colis.	Prix
							France	Euro 1	Euro 2	Euro 3	Euro 4		
Fermeture à levier h.44mm	-	-	-	00930170	1	-	00130170	-	-	-	-	1	-
Fermeture à levier h.70mm	-	-	-	00930171	1	-	00130171	-	-	-	-	1	-
Fermeture à levier h.90mm	-	-	-	00930172	1	-	00130172	-	-	-	-	1	-
Fermeture à levier cadenassable h.44mm	-	-	-	00930173	1	-	00130173	-	-	-	-	1	-
Fermeture à levier cadenassable h.70mm	-	-	-	00930174	1	-	00130174	-	-	-	-	1	-
Fermeture à levier cadenassable h.90mm	-	-	-	00930175	1	-	00130175	-	-	-	-	1	-

Non stocké/Non-stored/Producto no estocado - Sur stock Europe Zone 1 et Zone 2, nous consulter pour délai d'approvisionnement - Equipement/Stock depletion/Agotamiento del stock

Equipement de porte / PATTE DASSEMBLAGE ECO



GARANTIE

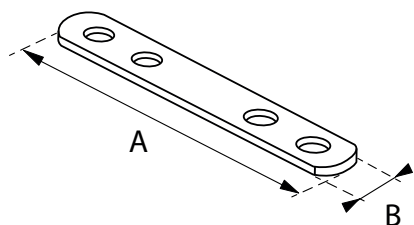

	A	B
987638	40	15
987639	60	15
987640	80	15
987641	100	15
987642	120	15

Description/Description/Descripción

Acier, bouts arrondis.

Steel, rounded ends.

Acero, extremos redondeados.

Finition/Finish/Acabado

Zingué.

Zinc plated.

Cincado.

Version/Option/Versión

Conditionnement .Blister. x 4pices

Blister pack x 4 pieces

Blister x 4 unidades

Designation	Boite	Colis.	Prix	Sachet	Colis.	Prix	Brochable					Colis.	Prix
							France	Euro 1	Euro 2	Euro 3	Euro 4		
Patte d'assemblage 40x15mm	-	-	-	00987638	1	-	00187638	-	-	-	-	4	-
Patte d'assemblage 60x15mm	-	-	-	00987639	1	-	00187639	-	-	-	-	4	-
Patte d'assemblage 80x15mm	-	-	-	00987640	1	-	00187640	-	-	-	-	4	-
Patte d'assemblage 100x15mm	-	-	-	00987641	1	-	00187641	-	-	-	-	4	-
Patte d'assemblage 120x15mm	-	-	-	00987642	1	-	00187642	-	-	-	-	4	-

⚠ Non stocké/Non-stored/Producto no estocado - 📦 Sur stock Europe Zone 1 et Zone 2, nous consulter pour délai d'approvisionnement - 🇪🇺 Epusement/Stock depletion/Agotamiento del stock

Equipement de porte / EQUERRE DE FENETRE ECO



GARANTIE

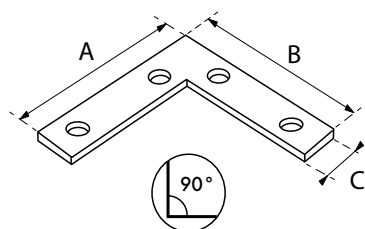

	A	B	C
987650	30	30	12,5
987651	40	40	12,5
987652	50	50	12,5
987653	60	60	12,5
987654	80	80	20
987655	100	100	20
987656	120	120	20
987657	140	140	20

Description/Description/Descripción

Acier, bouts carrés
Steel, square ends.
Acero, extremos cuadrados.

Finition/Finish/Acabado

Zingué.
Zinc plated.
Cincado.

Designation	Boite	Colis.	Prix	Sachet	Colis.	Prix	Brochable					Colis.	Prix
							France	Euro 1	Euro 2	Euro 3	Euro 4		
Equerre de fenetre 30x30x12,5mm	-	-	-	00987650	1	-	-	-	-	-	-	-	-
Equerre de fenetre 40x40x12,5mm	-	-	-	00987651	1	-	-	-	-	-	-	-	-
Equerre de fenetre 50x50x12,5mm	-	-	-	00987652	1	-	-	-	-	-	-	-	-
Equerre de fenetre 60x60x12,5mm	-	-	-	00987653	1	-	-	-	-	-	-	-	-
Equerre de fenetre 80x80x20mm	-	-	-	00987654	1	-	-	-	-	-	-	-	-
Equerre de fenetre 100x100x20mm	-	-	-	00987655	1	-	-	-	-	-	-	-	-
Equerre de fenetre 120x120x20mm	-	-	-	00987656	1	-	-	-	-	-	-	-	-
Equerre de fenetre 140x140x20mm	-	-	-	00987657	1	-	-	-	-	-	-	-	-

Non stocké/Non-stored/Producto no estocado - Sur stock Europe Zone 1 et Zone 2, nous consulter pour délai d'approvisionnement - Epuement/Stock depletion/Agotamiento del stock

Equipement de porte / EQUERRE DE CHAISE ECO



GARANTIE

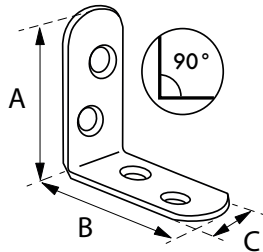

	A	B	C
987643	20	20	15
987644	30	30	15
987645	40	40	15
987646	50	50	15
987647	60	60	15

Description/Description/Descripción

Acier, bouts arrondis.

Steel, rounded ends.

Acero, extremos redondeados.

Finition/Finish/Acabado

Zingué.

Zinc plated.

Cincado.

Version/Option/Versión

Conditionnement .Blister. x 4pi

Blister pack x 4 pieces

Blister x 4 unidades

Designation	Boite	Colis.	Prix	Sachet	Colis.	Prix	Brochable					Colis.	Prix
							France	Euro 1	Euro 2	Euro 3	Euro 4		
Equerre de chaise 20x20x15mm	-	-	-	00987643	1	-	00187643	-	-	-	-	4	-
Equerre de chaise 30x30x15mm	-	-	-	00987644	1	-	00187644	-	-	-	-	4	-
Equerre de chaise 40x40x15mm	-	-	-	00987645	1	-	00187645	-	-	-	-	4	-
Equerre de chaise 50x50x15mm	-	-	-	00987646	1	-	00187646	-	-	-	-	4	-
Equerre de chaise 60x60x15mm	-	-	-	00987647	1	-	00187647	-	-	-	-	4	-

⚠ Non stocké/Non-stored/Producto no estocado - 📦 Sur stock Europe Zone 1 et Zone 2, nous consulter pour délai d'approvisionnement - 🇪🇺 Epuisement/Stock depletion/Agotamiento del stock

Equipement de porte / EQUERRE DE RENFORT ECO



GARANTIE

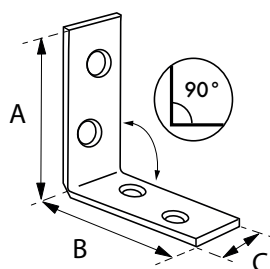

	A	B	C
987631	20	20	15
987632	30	30	15
987633	40	40	15
987634	50	50	15
987635	60	60	15
987636	70	70	15

Description/Description/Descripción

Acier.

Steel.

Acero.

Finition/Finish/Acabado

Zingué.

Zinc plated.

Cincado.

Version/Option/Versión

Conditionnement .Blister. x 4pi

Blister pack x 4 pieces

Blister x 4 unidades

Designation	Boite	Colis.	Prix	Sachet	Colis.	Prix	Brochable					Colis.	Prix
							France	Euro 1	Euro 2	Euro 3	Euro 4		
Equerre de renfort 20x20x15mm	-	-	-	00987631	1	-	00187631	-	-	-	-	4	-
Equerre de renfort 30x30x15mm	-	-	-	00987632	1	-	00187632	-	-	-	-	4	-
Equerre de renfort 40x40x15mm	-	-	-	00987633	1	-	00187633	-	-	-	-	4	-
Equerre de renfort 50x50x15mm	-	-	-	00987634	1	-	00187634	-	-	-	-	4	-
Equerre de renfort 60x60x15mm	-	-	-	00987635	1	-	00187635	-	-	-	-	4	-
Equerre de renfort 70x70x15mm	-	-	-	00987636	1	-	00187636	-	-	-	-	4	-

Non stocké/Non-stored/Producto no estocado - Sur stock Europe Zone 1 et Zone 2, nous consulter pour délai d'approvisionnement - Epuement/Stock depletion/Agotamiento del stock

Équipement / PATÈRE PROTECT

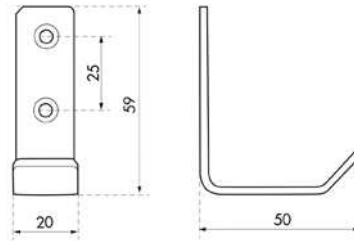

GARANTIE

Description/Description/Descripción

Acier inoxydable 304.
Stainless steel SS304.
Acero inoxidable 304.

Finition/Finish/Acabado

Satin
Satin
Satinado

Designation	Boite	Colis.	Prix	Sachet	Colis.	Prix	Brochable					Colis.	Prix
							France	Euro 1	Euro 2	Euro 3	Euro 4		
PATÈRE inox 20mm	00067520	10	-	-	-	-	-	-	-	-	-	-	-

Équipement / PATÈRE PROTECT

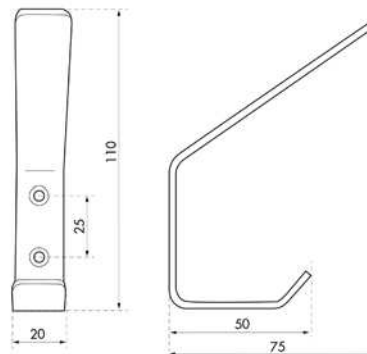

GARANTIE

Description/Description/Descripción

Acier inoxydable 304.
Stainless steel SS304.
Acero inoxidable 304.

Finition/Finish/Acabado

Satin
Satin
Satinado

Designation	Boite	Colis.	Prix	Sachet	Colis.	Prix	Brochable					Colis.	Prix
							France	Euro 1	Euro 2	Euro 3	Euro 4		
PATÈRE inox 18mm	00067521	10	-	-	-	-	-	-	-	-	-	-	-

Equipement / PATÈRE PROTECT

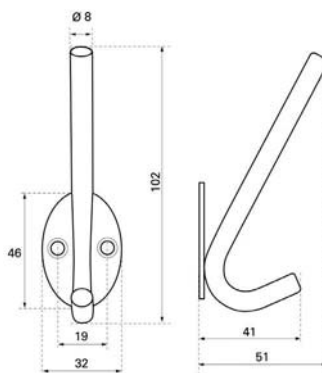

GARANTIE

Description/Description/Descripción

Acier inoxydable 304.
Stainless steel SS304.
Acero inoxidable 304.

Finition/Finish/Acabado

Satin
Satin
Satinado

Designation	Boite	Colis.	Prix	Sachet	Colis.	Prix	Brochable					Colis.	Prix
							France	Euro 1	Euro 2	Euro 3	Euro 4		
PATÈRE inox H.65mm	00067522	10	-	-	-	-	-	-	-	-	-	-	-

Equipement / PATÈRE PROTECT

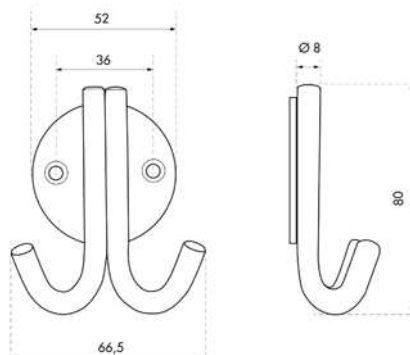

GARANTIE

Description/Description/Descripción

Acier inoxydable 304.
Stainless steel SS304.
Acero inoxidable 304.

Finition/Finish/Acabado

Satin
Satin
Satinado

Designation	Boite	Colis.	Prix	Sachet	Colis.	Prix	Brochable					Colis.	Prix
							France	Euro 1	Euro 2	Euro 3	Euro 4		
PATÈRE inox à double crochet	00067523	10	-	-	-	-	-	-	-	-	-	-	-

Non stocké/Non-stored/Producto no estocado - Sur stock Europe Zone 1 et Zone 2, nous consulter pour délai d'approvisionnement - Epuiseiment/Stock depletion/Agotamiento del stock

Equipment / PATÈRE PROTECT

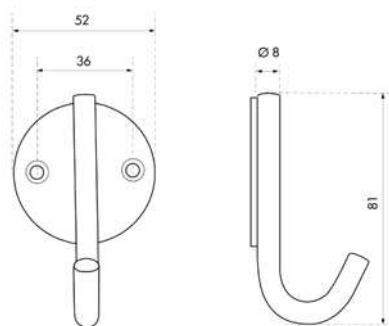

GARANTIE

Description/Description/Descripción

Acier inoxydable 304.
Stainless steel SS304.
Acero inoxidable 304.

Finition/Finish/Acabado

Satin
Satin
Satinado

Designation	Boite	Colis.	Prix	Sachet	Colis.	Prix	Brochable					Colis.	Prix
							France	Euro 1	Euro 2	Euro 3	Euro 4		
PATÈRE inox à simple crochet	00067524	10	-	-	-	-	-	-	-	-	-	-	-

Equipment / PATÈRE PROTECT

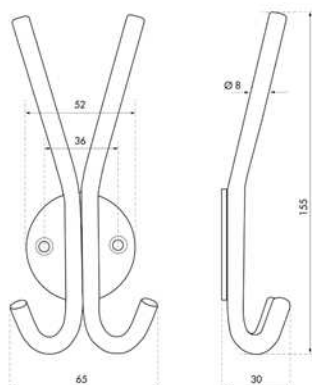

GARANTIE

Description/Description/Descripción

Acier inoxydable 304.
Stainless steel SS304.
Acero inoxidable 304.

Finition/Finish/Acabado

Satin
Satin
Satinado

Designation	Boite	Colis.	Prix	Sachet	Colis.	Prix	Brochable					Colis.	Prix
							France	Euro 1	Euro 2	Euro 3	Euro 4		
PATÈRE inox à double crochet	00067525	10	-	-	-	-	-	-	-	-	-	-	-

⚠ Non stocké/Non-stored/Producto no estocado - 📦 Sur stock Europe Zone 1 et Zone 2, nous consulter pour délai d'approvisionnement - 🇪🇺 Epuisement/Stock depletion/Agotamiento del stock

Equipement de porte / SIGNALÉTIQUE

ECO



GARANTIE



Description/Description/Descripción

Panneau Pvc. Marquage blanc sur fond bleu. Avec adhésif.

Pvc panel. White marking on blue background. With adhesive.

Panel de Pvc. Marca blanca sobre fondo azul. Con adhesivo.

Finition/Finish/Acabado

Aspect mat.

Matt appearance.

Aspecto mate.

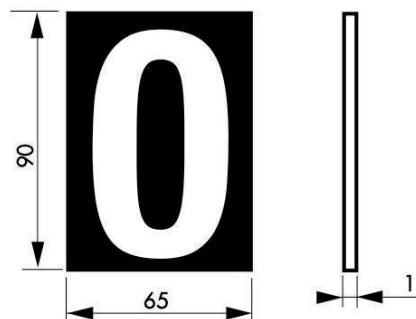

Designation	Boite	Colis.	Prix	Sachet	Colis.	Prix	Brochable					Colis.	Prix
							France	Euro 1	Euro 2	Euro 3	Euro 4		
PLAQUE SIGNALÉTIQUE 65x90mm «0» avec adhésif	-	-	-	00967180	10	-	-	-	-	-	-	-	-
PLAQUE SIGNALÉTIQUE 65x90mm «1» avec adhésif	-	-	-	00967181	10	-	-	-	-	-	-	-	-
PLAQUE SIGNALÉTIQUE 65x90mm «2» avec adhésif	-	-	-	00967182	10	-	-	-	-	-	-	-	-
PLAQUE SIGNALÉTIQUE 65x90mm «3» avec adhésif	-	-	-	00967183	10	-	-	-	-	-	-	-	-
PLAQUE SIGNALÉTIQUE 65x90mm «4» avec adhésif	-	-	-	00967184	10	-	-	-	-	-	-	-	-
PLAQUE SIGNALÉTIQUE 65x90mm «5» avec adhésif	-	-	-	00967185	10	-	-	-	-	-	-	-	-
PLAQUE SIGNALÉTIQUE 65x90mm «6» avec adhésif	-	-	-	00967186	10	-	-	-	-	-	-	-	-
PLAQUE SIGNALÉTIQUE 65x90mm «7» avec adhésif	-	-	-	00967187	10	-	-	-	-	-	-	-	-
PLAQUE SIGNALÉTIQUE 65x90mm «8» avec adhésif	-	-	-	00967188	10	-	-	-	-	-	-	-	-
PLAQUE SIGNALÉTIQUE 65x90mm «9» avec adhésif	-	-	-	00967189	10	-	-	-	-	-	-	-	-
PLAQUE SIGNALÉTIQUE 65x90mm «BIS» avec adhésif	-	-	-	00967116	10	-	-	-	-	-	-	-	-
PLAQUE SIGNALÉTIQUE 65x90mm «TER» avec adhésif	-	-	-	00967117	10	-	-	-	-	-	-	-	-

Non stocké/Non-stored/Producto no estocado - Sur stock Europe Zone 1 et Zone 2, nous consulter pour délai d'approvisionnement - Epuement/Stock depletion/Agotamiento del stock

Equipement de porte / SIGNALETIQUE

ECO



GARANTIE

Description/Description/Descripción

Panneau ABS. Marquage blanc sur fond noir. A visser.
ABS panel. White marking on black background. To be screwed.

Panel de ABS. Marca blanca sobre fondo negro. Para atornillar.

Finition/Finish/Acabado

Noir.

Black.

Negro.

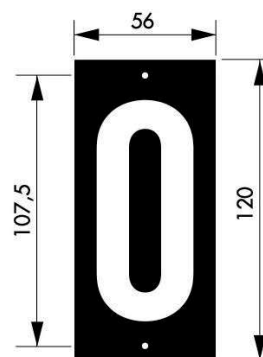

Designation	Boite	Colis.	Prix	Sachet	Colis.	Prix	Brochable					Colis.	Prix
							France	Euro 1	Euro 2	Euro 3	Euro 4		
PLAQUE SIGNALÉTIQUE 56x130mm «0» à visser	-	-	-	00967170	10	-	-	-	-	-	-	-	-
PLAQUE SIGNALÉTIQUE 56x130mm «1» à visser	-	-	-	00967171	10	-	-	-	-	-	-	-	-
PLAQUE SIGNALÉTIQUE 56x130mm «2» à visser	-	-	-	00967172	10	-	-	-	-	-	-	-	-
PLAQUE SIGNALÉTIQUE 56x130mm «3» à visser	-	-	-	00967173	10	-	-	-	-	-	-	-	-
PLAQUE SIGNALÉTIQUE 56x130mm «4» à visser	-	-	-	00967174	10	-	-	-	-	-	-	-	-
PLAQUE SIGNALÉTIQUE 56x130mm «5» à visser	-	-	-	00967175	10	-	-	-	-	-	-	-	-
PLAQUE SIGNALÉTIQUE 56x130mm «6» à visser	-	-	-	00967176	10	-	-	-	-	-	-	-	-
PLAQUE SIGNALÉTIQUE 56x130mm «7» à visser	-	-	-	00967177	10	-	-	-	-	-	-	-	-
PLAQUE SIGNALÉTIQUE 56x130mm «8» à visser	-	-	-	00967178	10	-	-	-	-	-	-	-	-
PLAQUE SIGNALÉTIQUE 56x130mm «9» à visser	-	-	-	00967179	10	-	-	-	-	-	-	-	-
PLAQUE SIGNALÉTIQUE 56x130mm «BIS» à visser	-	-	-	00967112	10	-	-	-	-	-	-	-	-
PLAQUE SIGNALÉTIQUE 56x130mm «TER» à visser	-	-	-	00967113	10	-	-	-	-	-	-	-	-

⚠ Non stocké/Non-stored/Producto no estocado - 📦 Sur stock Europe Zone 1 et Zone 2, nous consulter pour délai d'approvisionnement - 🇪🇺 Epuisement/Stock depletion/Agotamiento del stock

Equipement de porte / SIGNALÉTIQUE

ECO



GARANTIE

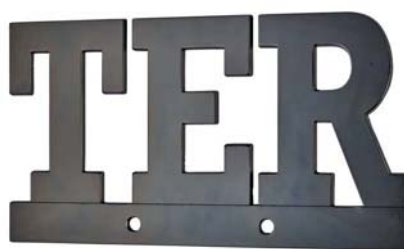

Description/Description/Descripción

Corps alliage. A visser.

Alloy body. To be screwed.

Cuerpo de aleación. Para atornillar

Finition/Finish/Acabado

Noir.

Black.

Negro.

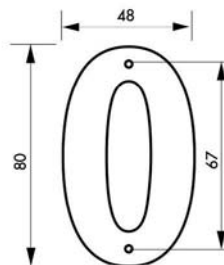

Designation	Boite	Colis.	Prix	Sachet	Colis.	Prix	Brochable					Colis.	Prix
							France	Euro 1	Euro 2	Euro 3	Euro 4		
CHIFFRE «0» hauteur 80mm noir à visser	-	-	-	-	-	-	00967160	-	-	-	-	10	-
CHIFFRE «1» hauteur 80mm noir à visser	-	-	-	-	-	-	00967161	-	-	-	-	10	-
CHIFFRE «2» hauteur 80mm noir à visser	-	-	-	-	-	-	00967162	-	-	-	-	10	-
CHIFFRE «3» hauteur 80mm noir à visser	-	-	-	-	-	-	00967163	-	-	-	-	10	-
CHIFFRE «4» hauteur 80mm noir à visser	-	-	-	-	-	-	00967164	-	-	-	-	10	-
CHIFFRE «5» hauteur 80mm noir à visser	-	-	-	-	-	-	00967165	-	-	-	-	10	-
CHIFFRE «6» hauteur 80mm noir à visser	-	-	-	-	-	-	00967166	-	-	-	-	10	-
CHIFFRE «7» hauteur 80mm noir à visser	-	-	-	-	-	-	00967167	-	-	-	-	10	-
CHIFFRE «8» hauteur 80mm noir à visser	-	-	-	-	-	-	00967168	-	-	-	-	10	-
CHIFFRE «9» hauteur 80mm noir à visser	-	-	-	-	-	-	00967169	-	-	-	-	10	-
LETTRES «BIS» hauteur 80mm noir à visser	-	-	-	-	-	-	00967114	-	-	-	-	10	-
LETTRES «TER» hauteur 75mm noir à visser	-	-	-	-	-	-	00967115	-	-	-	-	10	-

Non stocké/Non-stored/Producto no estocado - Sur stock Europe Zone 1 et Zone 2, nous consulter pour délai d'approvisionnement - Epuisement/Stock depletion/Agotamiento del stock

Equipement de porte / SIGNALETIQUE

ECO



GARANTIE

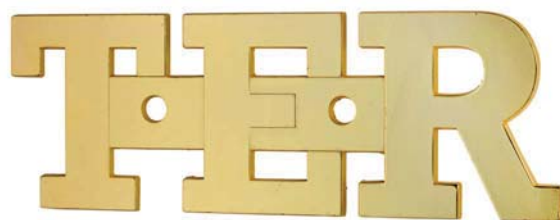

Description/Description/Descripción

Corps laiton. A visser.

Brass body. To be screwed.

Cuerpo de latón. Para atornillar

Finition/Finish/Acabado

Laiton.

Brass.

Latón.

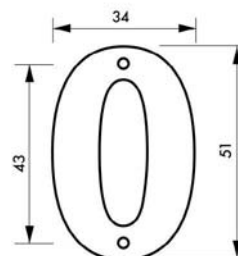

Designation	Boite	Colis.	Prix	Sachet	Colis.	Prix	Brochable					Colis.	Prix
							France	Euro 1	Euro 2	Euro 3	Euro 4		
CHIFFRE «0» hauteur 51mm à visser	-	-	-	00967190	10	-	-	-	-	-	-	-	-
CHIFFRE «1» hauteur 51mm à visser	-	-	-	00967191	10	-	-	-	-	-	-	-	-
CHIFFRE «2» hauteur 51mm à visser	-	-	-	00967192	10	-	-	-	-	-	-	-	-
CHIFFRE «3» hauteur 51mm à visser	-	-	-	00967193	10	-	-	-	-	-	-	-	-
CHIFFRE «4» hauteur 51mm à visser	-	-	-	00967194	10	-	-	-	-	-	-	-	-
CHIFFRE «5» hauteur 51mm à visser	-	-	-	00967195	10	-	-	-	-	-	-	-	-
CHIFFRE «6» hauteur 51mm à visser	-	-	-	00967196	10	-	-	-	-	-	-	-	-
CHIFFRE «7» hauteur 51mm à visser	-	-	-	00967197	10	-	-	-	-	-	-	-	-
CHIFFRE «8» hauteur 51mm à visser	-	-	-	00967198	10	-	-	-	-	-	-	-	-
CHIFFRE «9» hauteur 51mm à visser	-	-	-	00967199	10	-	-	-	-	-	-	-	-
LETTRES «BIS» hauteur 51mm à visser	-	-	-	00967122	10	-	-	-	-	-	-	-	-
LETTRES «TER» hauteur 51mm à visser	-	-	-	00967123	10	-	-	-	-	-	-	-	-

Non stocké/Non-stored/Producto no estocado - Sur stock Europe Zone 1 et Zone 2, nous consulter pour délai d'approvisionnement - E Epusement/Stock depletion/Agotamiento del stock

Equipement de porte / SIGNALÉTIQUE

ECO

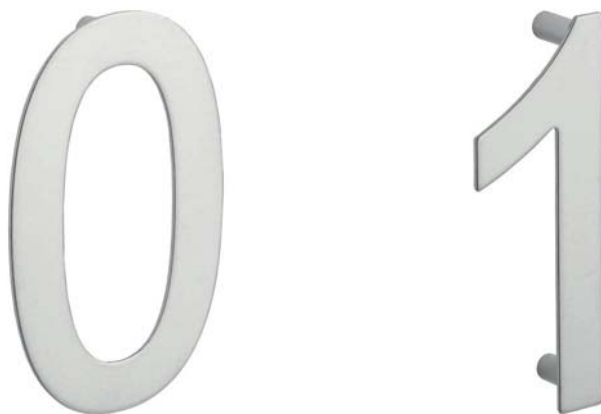

GARANTIE

Description/Description/Descripción

Acier inoxydable 304. Entretoises soudées au dos. A visser.

Stainless steel SS304. With legs on backside. To screw.
Acero inoxidable 304. Con espaciadores en la parte posterior. Atornillar.

Finition/Finish/Acabado

Satin

Satin

Satinado

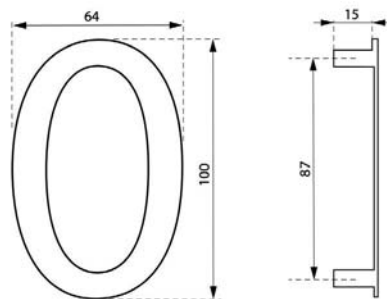

Designation	Boite	Colis.	Prix	Sachet	Colis.	Prix	Brochable					Colis.	Prix
							France	Euro 1	Euro 2	Euro 3	Euro 4		
Chiffre «0» inox H.100mm à visser	-	-	-	-	-	-	00967550	-	-	-	-	10	-
Chiffre «1» inox H.100mm à visser	-	-	-	-	-	-	00967551	-	-	-	-	10	-
Chiffre «2» inox H.100mm à visser	-	-	-	-	-	-	00967552	-	-	-	-	10	-
Chiffre «3» inox H.100mm à visser	-	-	-	-	-	-	00967553	-	-	-	-	10	-
Chiffre «4» inox H.100mm à visser	-	-	-	-	-	-	00967554	-	-	-	-	10	-
Chiffre «5» inox H.100mm à visser	-	-	-	-	-	-	00967555	-	-	-	-	10	-
Chiffre «6» inox H.100mm à visser	-	-	-	-	-	-	00967556	-	-	-	-	10	-
Chiffre «7» inox H.100mm à visser	-	-	-	-	-	-	00967557	-	-	-	-	10	-
Chiffre «8» inox H.100mm à visser	-	-	-	-	-	-	00967558	-	-	-	-	10	-
Chiffre «9» inox H.76mm adhésif	-	-	-	-	-	-	00967569	-	-	-	-	10	-
Lettre «Bis» inox H.76mm adhésive	-	-	-	-	-	-	00967594	-	-	-	-	10	-
Lettre «Ter» inox H.76mm adhésive	-	-	-	-	-	-	00967595	-	-	-	-	10	-

Non stocké/Non-stored/Producto no estocado - Sur stock Europe Zone 1 et Zone 2, nous consulter pour délai d'approvisionnement - Equipement/Stock depletion/Agotamiento del stock

Equipement de porte / SIGNALÉTIQUE

ECO

Description/Description/Descripción

Acier inoxydable 304. Adhésif 3M.
Stainless steel SS304. With 3M sticker.
Acero inoxidable 304. Adhesivo.

Finition/Finish/Acabado

Satin
Satin
Satinado

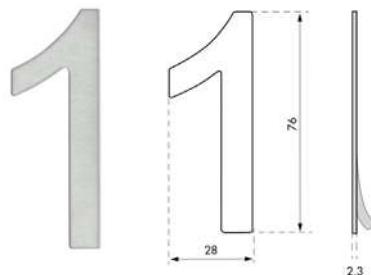

GARANTIE

Designation	Boite	Colis.	Prix	Sachet	Colis.	Prix	Brochable					Colis.	Prix
							France	Euro 1	Euro 2	Euro 3	Euro 4		
Chiffre «0» inox H.76mm adhésif	00067560	10	-	-	-	-	-	-	-	-	-	-	-
Chiffre «1» inox H.76mm adhésif	00067561	10	-	-	-	-	-	-	-	-	-	-	-
Chiffre «2» inox H.76mm adhésif	00067562	10	-	-	-	-	-	-	-	-	-	-	-
Chiffre «3» inox H.76mm adhésif	00067563	10	-	-	-	-	-	-	-	-	-	-	-
Chiffre «4» inox H.76mm adhésif	00067564	10	-	-	-	-	-	-	-	-	-	-	-
Chiffre «5» inox H.76mm adhésif	00067565	10	-	-	-	-	-	-	-	-	-	-	-
Chiffre «6» inox H.76mm adhésif	00067566	10	-	-	-	-	-	-	-	-	-	-	-
Chiffre «7» inox H.76mm adhésif	00067567	10	-	-	-	-	-	-	-	-	-	-	-
Chiffre «8» inox H.76mm adhésif	00067568	10	-	-	-	-	-	-	-	-	-	-	-
Chiffre «9» inox H.100mm à visser	00067559	10	-	-	-	-	-	-	-	-	-	-	-

Equipement de porte / SIGNALÉTIQUE

ECO

Description/Description/Descripción

Acier inoxydable 304. Adhésif 3M.
Stainless steel SS304. With 3M sticker.
Acero inoxidable 304. Adhesivo.

Finition/Finish/Acabado

Satin
Satin
Satinado

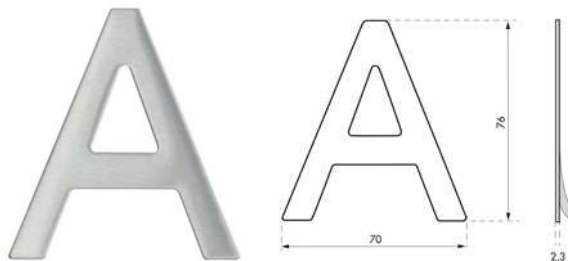

GARANTIE

Designation	Boite	Colis.	Prix	Sachet	Colis.	Prix	Brochable					Colis.	Prix
							France	Euro 1	Euro 2	Euro 3	Euro 4		
Lettre «A» inox H.76mm adhésif	00067548	10	-	-	-	-	-	-	-	-	-	-	-
Lettre «B» inox H.76mm adhésif	00067549	10	-	-	-	-	-	-	-	-	-	-	-

⚠ Non stocké/Non-stored/Producto no estocado - 📦 Sur stock Europe Zone 1 et Zone 2, nous consulter pour délai d'approvisionnement - 📦 Epuisement/Stock depletion/Agotamiento del stock

Equipement de porte / SIGNALETIQUE ECO



GARANTIE

Description/Description/Descripción

Corps ABS. Avec adhésif.
ABS body. With adhesive.
Cuerpo de ABS. Con adhesivo.

Finition/Finish/Acabado

Doré
Golden finish
Dorado

Designation	Boite	Colis.	Prix	Sachet	Colis.	Prix	Brochable					Colis.	Prix
							France	Euro 1	Euro 2	Euro 3	Euro 4		
CHIFFRE 0 H.50MM FINITION LAITONNEE - ADHESIF	-	-	-	-	-	-	00967200	-	-	-	-	5	-
CHIFFRE 1 H.50MM FINITION LAITONNEE - ADHESIF	-	-	-	-	-	-	00967201	-	-	-	-	5	-
CHIFFRE 2 H.50MM FINITION LAITONNEE - ADHESIF	-	-	-	-	-	-	00967202	-	-	-	-	5	-
CHIFFRE 3 H.50MM FINITION LAITONNEE - ADHESIF	-	-	-	-	-	-	00967203	-	-	-	-	5	-
CHIFFRE 4 H.50MM FINITION LAITONNEE - ADHESIF	-	-	-	-	-	-	00967204	-	-	-	-	5	-
CHIFFRE 5 H.50MM FINITION LAITONNEE - ADHESIF	-	-	-	-	-	-	00967205	-	-	-	-	5	-
CHIFFRE 6 H.50MM FINITION LAITONNEE - ADHESIF	-	-	-	-	-	-	00967206	-	-	-	-	5	-
CHIFFRE 7 H.50MM FINITION LAITONNEE - ADHESIF	-	-	-	-	-	-	00967207	-	-	-	-	5	-
CHIFFRE 8 H.50MM FINITION LAITONNEE - ADHESIF	-	-	-	-	-	-	00967208	-	-	-	-	5	-
CHIFFRE 9 H.50MM FINITION LAITONNEE - ADHESIF	-	-	-	-	-	-	00967209	-	-	-	-	5	-

Non stocké/Non-stored/Producto no estocado - Sur stock Europe Zone 1 et Zone 2, nous consulter pour délai d'approvisionnement - Epuisement/Stock depletion/Agotamiento del stock

Equipement de porte / SIGNALÉTIQUE

ECO

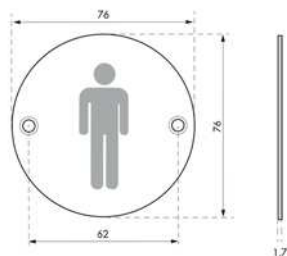

GARANTIE

Description/Description/Descripción

Acier inoxydable 304. Marquage noir. A visser.
 Stainless steel SS304. Black print. To screw.
 Acero inoxidable 304. Estampado negro. Atornillar.

Finition/Finish/Acabado

Brossé
 Brushed
 Cepillado

Designation	Boite	Colis.	Prix	Sachet	Colis.	Prix	Brochable					Colis.	Prix
							France	Euro 1	Euro 2	Euro 3	Euro 4		
Disque signalétique Ø 76mm WC - Homme - à visser	00067530	10	-	-	-	-	-	-	-	-	-	-	-
Disque signalétique Ø 76mm WC - Femme - à visser	00067531	10	-	-	-	-	-	-	-	-	-	-	-
Disque signalétique Ø 76mm WC - Homme/Femme - à visser	00067532	10	-	-	-	-	-	-	-	-	-	-	-
Disque signalétique Ø 76mm WC - Handicapé - à visser	00067533	10	-	-	-	-	-	-	-	-	-	-	-
Disque signalétique Ø 76mm DOUCHE - à visser	00067534	10	-	-	-	-	-	-	-	-	-	-	-
Disque signalétique Ø 76mm ESPACE BÉBÉ- à visser	00067535	10	-	-	-	-	-	-	-	-	-	-	-
Plaque signalétique 100x100 mm DÉFENSE DE FUMER - à visser	00067536	10	-	-	-	-	-	-	-	-	-	-	-
Plaque signalétique 100x100 mm WC - Homme - à visser	00067537	10	-	-	-	-	-	-	-	-	-	-	-
Plaque signalétique 100x100 mm WC - Femme - à visser	00067538	10	-	-	-	-	-	-	-	-	-	-	-
Plaque signalétique 100x100 mm WC - Homme/Femme - à visser	00067539	10	-	-	-	-	-	-	-	-	-	-	-
Plaque signalétique 100x100 mm WC - Handicapé - à visser	00067540	10	-	-	-	-	-	-	-	-	-	-	-
Plaque signalétique 100x100 mm DOUCHE - à visser	00067541	10	-	-	-	-	-	-	-	-	-	-	-
Plaque signalétique 100x100 mm ESPACE BÉBÉ - à visser	00067542	10	-	-	-	-	-	-	-	-	-	-	-

⚠ Non stocké/Non-stored/Producto no estocado - 📦 Sur stock Europe Zone 1 et Zone 2, nous consulter pour délai d'approvisionnement - 📦 Epuisement/Stock depletion/Agotamiento del stock

Equipement de porte / SIGNALETIQUE

ECO

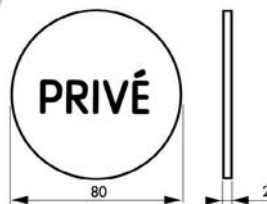

GARANTIE

Description/Description/Descripción

Plaque aluminium. Pictogramme noir. Avec adhésif.
 Aluminium plate. Black pictogram. With adhesive.
 Placa de aluminio. Pictograma negro. Con adhesivo.

Finition/Finish/Acabado

Brossé.
 Brushed.
 Cepillado.

Designation	Boite	Colis.	Prix	Sachet	Colis.	Prix	Brochable					Colis.	Prix
							France	Euro 1	Euro 2	Euro 3	Euro 4		
DISQUE SIGNALÉTIQUE Ø 80mm «Privé» avec adhésif	-	-	-	00967156	10	-	-	-	-	-	-	-	-
DISQUE SIGNALÉTIQUE Ø 80mm «WC» avec adhésif	-	-	-	00967157	10	-	-	-	-	-	-	-	-
DISQUE SIGNALÉTIQUE Ø 80mm «handicapé» avec adhésif	-	-	-	00967158	10	-	-	-	-	-	-	-	-
DISQUE SIGNALÉTIQUE Ø 80mm «Pas de publicité» avec adhésif	-	-	-	00967159	10	-	-	-	-	-	-	-	-

Equipement de porte / SIGNALETIQUE

ECO



GARANTIE

Description/Description/Descripción

Panneau en polystyrène choc rigide. A visser.
 Rigid impact polystyrene panel. To be screwed.
 Panel de poliestireno de impacto rígido. Para atornillar.

Finition/Finish/Acabado

Aspect brillant.
 Glossy appearance.
 Aspecto brillante.

Designation	Boite	Colis.	Prix	Sachet	Colis.	Prix	Brochable					Colis.	Prix
							France	Euro 1	Euro 2	Euro 3	Euro 4		
PLAQUE SIGNALÉTIQUE 148x210mm «Interdiction de fumer» à visser	-	-	-	00967145	10	-	-	-	-	-	-	-	-

Equipement de porte / SIGNALETIQUE

ECO



Description/Description/Descripción

Panneau en polystyrène choc rigide. Avec adhésif.

Rigid impact polystyrene panel. With adhesive.

Panel de poliestireno de impacto rígido. Con adhesivo

Designation	Boite	Colis.	Prix	Sachet	Colis.	Prix	Brochable					Colis.	Prix
							France	Euro 1	Euro 2	Euro 3	Euro 4		
PLAQUE SIGNALÉTIQUE Ø 80mm «Défense de fumer» avec adhésif	-	-	-	00967141	10	-	-	-	-	-	-	-	-
PLAQUE SIGNALÉTIQUE Ø 80mm «Vidéoprotection 24/24» avec adhésif	-	-	-	00967142	10	-	-	-	-	-	-	-	-
PLAQUE SIGNALÉTIQUE Ø 80mm «Attention au chien» avec adhésif	-	-	-	00967143	10	-	-	-	-	-	-	-	-
PLAQUE SIGNALÉTIQUE Ø 80mm «Pas de publicité» avec adhésif	-	-	-	00967144	10	-	-	-	-	-	-	-	-

Equipement de porte / SIGNALETIQUE

ECO



Description/Description/Descripción

Panneau en polystyrène choc rigide. Avec adhésif.

Rigid impact polystyrene panel. With adhesive.

Panel de poliestireno de impacto rígido. Con adhesivo.

Designation	Boite	Colis.	Prix	Sachet	Colis.	Prix	Brochable					Colis.	Prix
							France	Euro 1	Euro 2	Euro 3	Euro 4		
PLAQUE SIGNALÉTIQUE Ø 180mm «Propriété privée» avec adhésif	-	-	-	00967134	10	-	-	-	-	-	-	-	-
PLAQUE SIGNALÉTIQUE Ø 180mm «Stationnement interdit» avec adhésif	-	-	-	00967135	10	-	-	-	-	-	-	-	-
PLAQUE SIGNALÉTIQUE Ø 180mm «Sortie de voiture» avec adhésif	-	-	-	00967136	10	-	-	-	-	-	-	-	-
PLAQUE SIGNALÉTIQUE Ø 180mm «Interdiction de fumer» avec adhésif	-	-	-	00967137	10	-	-	-	-	-	-	-	-
PLAQUE SIGNALÉTIQUE Ø 180mm «Interdiction de vapoter» avec adhésif	-	-	-	00967138	10	-	-	-	-	-	-	-	-
PLAQUE SIGNALÉTIQUE Ø 180mm «Vidéoprotection 24/24» avec adhésif	-	-	-	00967139	10	-	-	-	-	-	-	-	-
PLAQUE SIGNALÉTIQUE Ø 180mm «Attention au chien» avec adhésif	-	-	-	00967140	10	-	-	-	-	-	-	-	-

⚠ Non stocké/Non-stored/Producto no estocado - ☑ Sur stock Europe Zone 1 et Zone 2, nous consulter pour délai d'approvisionnement - ☒ Epuisement/Stock depletion/Agotamiento del stock

Equipement de porte / SIGNALÉTIQUE

ECO



Description/Description/Descripción

Plaque plexiglass. Avec adhésif.

Plexiglass plate. With adhesive.

Placa de plexiglàs. Con adhesivo.

Finition/Finish/Acabado

Aspect brillant.

Glossy appearance

Aspecto brillante.

Designation	Boite	Colis.	Prix	Sachet	Colis.	Prix	Brochable					Colis.	Prix
							France	Euro 1	Euro 2	Euro 3	Euro 4		
PLAQUE SIGNALÉTIQUE 170x45mm «Sortie de secours» avec adhésif	-	-	-	00967146	10	-	-	-	-	-	-	-	-
PLAQUE SIGNALÉTIQUE 170x45mm «Défense de fumer» avec adhésif	-	-	-	00967147	10	-	-	-	-	-	-	-	-
PLAQUE SIGNALÉTIQUE 170x45mm «Espace sous surveillance» avec adhésif	-	-	-	00967148	10	-	-	-	-	-	-	-	-
PLAQUE SIGNALÉTIQUE 170x45mm «Espace Wifi» avec adhésif	-	-	-	00967149	10	-	-	-	-	-	-	-	-
PLAQUE SIGNALÉTIQUE 170x45mm «Attention au chien» avec adhésif	-	-	-	00967150	10	-	-	-	-	-	-	-	-
PLAQUE SIGNALÉTIQUE 170x45mm «Privé» avec adhésif	-	-	-	00967151	10	-	-	-	-	-	-	-	-
PLAQUE SIGNALÉTIQUE 170x45mm «Dames» avec adhésif	-	-	-	00967152	10	-	-	-	-	-	-	-	-
PLAQUE SIGNALÉTIQUE 170x45mm «Messieurs» avec adhésif	-	-	-	00967153	10	-	-	-	-	-	-	-	-
PLAQUE SIGNALÉTIQUE 170x45mm «Toilettes» avec adhésif	-	-	-	00967154	10	-	-	-	-	-	-	-	-
PLAQUE SIGNALÉTIQUE 170x45mm «WC» avec adhésif	-	-	-	00967155	10	-	-	-	-	-	-	-	-

☒ Non stocké/Non-stored/Producto no estocado - ☑ Sur stock Europe Zone 1 et Zone 2, nous consulter pour délai d'approvisionnement - ☒ Epuement/Stock depletion/Agotamiento del stock

Équipement / CENDRIER MURAL

ECO



GARANTIE



X 2

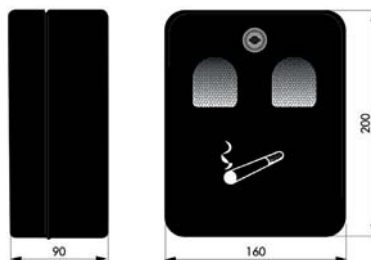
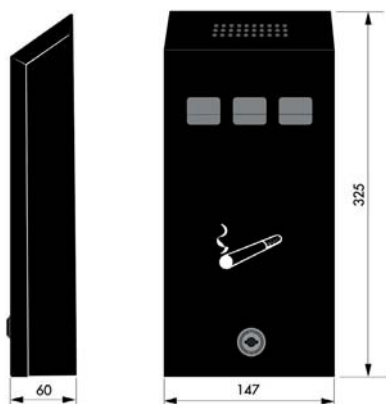

Description/Description/Descripción

Coffre acier. Compartiment amovible acier zingué. Verrouillage par batteuse fourni avec 2 clés. Fixation murale (accessoires fournis).

Steel case. Removable zinc plated steel compartment. Locking thanks to Cam-Lock provide with 2 keys. Wall mounted (accessories supplied).

Caja de acero. Compartimento extraíble de acero galvanizado. Cierre por cerradura con leva con 2 llaves. Instalación en la pared. (accesorios suministrados).

Finition/Finish/Acabado

Epoxy noir granité

Granited black epoxy

Epoxi negro granitado.

Designation	Boite	Colis.	Prix	Sachet	Colis.	Prix	Brochable					Colis.	Prix
							France	Euro 1	Euro 2	Euro 3	Euro 4		
Cendrier mural 325 x 147 x 60mm - 2 clés	00012238	1	-	-	-	-	-	-	-	-	-	-	-
Cendrier mural 200 x 160 x 90mm - 2 clés	00012239	1	-	-	-	-	-	-	-	-	-	-	-

⚠ Non stocké/Non-stored/Producto no estocado - 📦 Sur stock Europe Zone 1 et Zone 2, nous consulter pour délai d'approvisionnement - 🇪🇺 Epusement/Stock depletion/Agotamiento del stock

Equipement / MIROIR

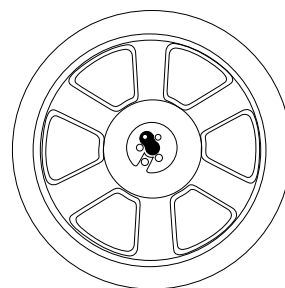
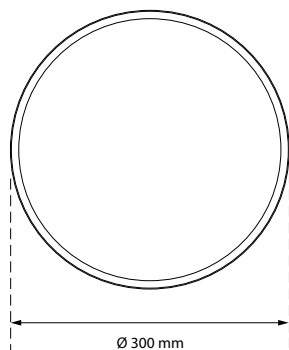

Description/Description/Descripción

Corps ABS. Miroir acrylique diamètre 300mm. Fixation murale fournie.

ABS body. Acrylic mirror diameter 300mm. Wall mounting supplied.

Cuerpo de ABS. Espejo acrílico de 300 mm de diámetro. Se suministra el montaje en la pared.

Utilisation/Use/Utilización

Intérieur/extérieur. Parking, garage, intersection.

Indoor/outdoor. Parking, garage, intersection.

Interior/exterior. Párking, garaje, intersección.

Designation	Boite	Colis.	Prix	Sachet	Colis.	Prix	Brochable					Colis.	Prix
							France	Euro 1	Euro 2	Euro 3	Euro 4		
MIROIR DE CIRCULATION CONVEXE DIAM.30CM - INT/EXT	00090662	1	-	-	-	-		-	-	-	-	-	-

Equipement / BARRIERE

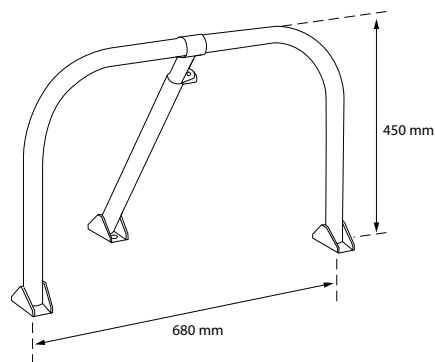

Description/Description/Descripción

Tube acier diamètre 32mm. Bandes réfléchissantes. Verrouillage par cadenas (non fourni). Fixation au sol (Accessoires fournis).

Steel tube diameter 32mm. Reflective strips. Locking by padlock (not supplied). Floor fixing (accessories supplied).

Tubo de acero de 32 mm de diámetro. Tiras reflectantes. Cierre con candado (no suministrado). Fijación al suelo (accesorios suministrados).

Finition/Finish/Acabado

Gris avec bandes réfléchissantes

Grey with reflective stripes

Gris con bandas reflectantes

Utilisation/Use/Utilización

Intérieur/extérieur. Parking, garage.

Indoor/outdoor. Parking, garage.

Interior/exterior. Párking, garaje.

Designation	Boite	Colis.	Prix	Sachet	Colis.	Prix	Brochable					Colis.	Prix
							France	Euro 1	Euro 2	Euro 3	Euro 4		
BARRIERE DE PARKING RABATTALE - FERMETURE PAR CADENAS	00090663	1	-	-	-	-		-	-	-	-	-	-

⊗ Non stocké/Non-stored/Producto no estocado - ⊠ Sur stock Europe Zone 1 et Zone 2, nous consulter pour délai d'approvisionnement - ⊞ Epuisement/Stock depletion/Agotamiento del stock

Equipment / CHAINE



Description/Description/Descripción

Corps polypropylène. Longueur 2,50m. Diamètre 6mm.
 Polypropylene body. Length 2,50m. Diameter 6mm.
 Cuerpo de polipropileno. Longitud 2,50m. Diámetro 6mm.

Finition/Finish/Acabado

Rouge/Blanc / Red/White / Rojo/Blanco

Utilisation/Use/Utilización

Signalisation, balisage, délimitation.
 signage, marking. / Señalización, delimitación.

Designation	Boite	Colis.	Prix	Sachet	Colis.	Prix	Brochable					Colis.	Prix
							France	Euro 1	Euro 2	Euro 3	Euro 4		
CHAINE DE SIGNALISATION PLASTIQUE ROUGE/BLANC DIAM.6MMX2.50M	-	-	-	-	-	-	00990660	-	-	-	-	1	-

Equipment / MAILLONS



Description/Description/Descripción

Corps polypropylène. Diamètre 6mm.
 Polypropylene body. Diameter 6mm.
 Cuerpo de polipropileno. Diámetro 6mm.

Rouge/Blanc / Red/White / Rojo/Blanco

Utilisation/Use/Utilización

Signalisation, balisage, délimitation.
 signage, marking. / Señalización, delimitación.

Designation	Boite	Colis.	Prix	Sachet	Colis.	Prix	Brochable					Colis.	Prix
							France	Euro 1	Euro 2	Euro 3	Euro 4		
LOT DE 2 MAILLONS RAPIDES ROUGE/BLANC DIAM.6MM	-	-	-	-	-	-	00990661	-	-	-	-	1	-











Notes





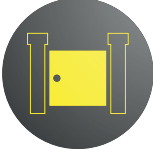

Verrous

PORTE D'ENTRÉE		362	PORTE D'ENTRÉE VITRÉE		393
PORTE INTÉRIEURE		418	PORTE DE SALLE DE BAINS		422
PORTE DE CAVE		425	PORTE DE GARAGE		427
PORTAIL		430	MEUBLES		438
FENÊTRE		450	CONTRÔLE ACCÈS MÉCANIQUE		460
ACCESSOIRES		464			



*Sommaire détaillé par produit
page suivante*



Verrous

PORTE D'ENTRÉE



Verrou à capot		362
Etendard		363
Concorde		364
Corvette		365
2310		366
Design		367
Universel		368
Universel à languette		369
Universel à languette		370
Verrou multipoints Mirage 6		371
Verrou multipoints Mirage 6		372
Adriatic 2		373
Trafic 6		374
Universel		375
Universel à languette		376
Apache		377
Rafale		378
Transit 2		379

Capital		381
La clé unique		382
Surveyor		384
Atlantic M		385
Fédéral		386
Plaisance		387
Mirage		388
Inox		389
Cobra		390
Verrou de haute sûreté Transit 2 A2P*		391
Verrou de haute sûreté Adriatic A2P*		392

PORTE D'ENTRÉE VITRÉE







Etendard		393
Concorde		394
Corvette		395
Design		396
Universel		397
Universel à languette		398
Universel à languette		399

Verrou multipoints Mirage 6		400
Verrou multipoints Mirage 6		401
Trafic 6		402
Adriatic 2		403
Universel		404
Universel à languette		405
Apache		406
Rafale		407
Transit 2		409
Capital		411
Surveyor		412
Atlantic m		413
Fédéral		414
Cobra		415
Verrou de haute sûreté Transit 2 A2P*		416
Verrou de haute sûreté Adriatic A2P*		417

PORTE INTÉRIEURE







Concorde		418
Trident		418
Vspm		419

Alouette		419
Trident		420
Corvette		420
Apache		421
Capital		421

PORTE DE SALLE DE BAINS



Automatique WC		422
Alouette WC		422
Automatique WC		423
Automatique WC		423
Automatique WC		424

PORTE DE CAVE



Etendard		425
Corvette		425
Capital		426

PORTE DE GARAGE





Corvette		427
Apache		428
Capital		429

PORTAIL

















Verrou transversal		430
Pêne rond		431
à porte cadenas		432
Verrou à ressort		433
Cadenassable		433
Verrou porte cadenas		434
Verrou porte cadenas		435
Coulissant cadenassable		436

Targette à combinaison		436
Mirage		437

MEUBLES







Pêne rond		438
Pêne plat		439
Pêne rond		439
Verrou automatique pêne plat		440
Verrou automatique Alouette		441
Pêne rond laiton		442
Pêne plat		443
Pêne rond		444
Pêne rond		445
Pêne plat		446
Louis XVI		447
Rustique		447
Pêne rond inox		448
Pêne plat inox		448
Verrou automatique pêne plat		449

FENÊTRE







A larder		450
Pour baie coulissante		451
Loqueteau		451
Loqueteau		452
Loqueteau		452
A clé universelle		453
A clé universelle		453
Loqueteau à clé		454
Loqueteau à clé		454
A cylindre		455
A cylindre		455







A cylindre		456
Verrou à clé		457
Pour baie coulissante		458
Pour baie coulissante		459

CONTRÔLE ACCÈS MÉCANIQUE



A combinaison		460
A combinaison		461
A combinaison		462
A combinaison		463

ACCESSOIRES

Gâche		464
Gâche renforcée		465
Plaque de renfort		466
Entrée / Rosace		467
Lubrifiant		468
Lubrifiant		468
Accessoires/ suppléments pour verrous		469



Verrou de sûreté / A CAPOT

ECO



NIVEAU DE SÉCURITÉ



GARANTIE



X 4

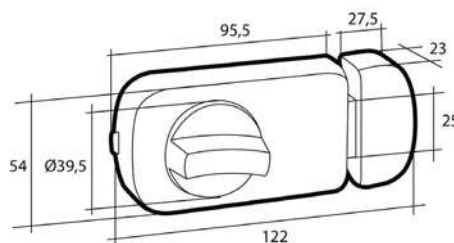
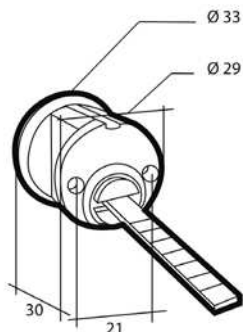

Description/Description/Descripción

Verrou applique 1 point avec cylindre à languette recouvrable. Livré avec gâches à encastrer / appliquer et câles pour porte à recouvrement. 4 clés réversibles.

1-point surface lock with cylinder with adjustable tab. Delivered with strikes to countersunk / applied and stops for cover door. 4 reversible keys.

Pestillo aplique 1 punto con cilindro lengüeta recortable. Se entrega con gachetas encastrables / en plastrón y calces para puerta con recubrimiento. 4 llaves reversibles.

Finition/Finish/Acabado

Gris
Brushed stainless steel
Acero inoxidable

Utilisation/Use/Utilización

Porte d'entrée
Entrance door
Puerta de entrada

Designation	Boite	Colis.	Prix	Sachet	Colis.	Prix	Brochable					Colis.	Prix
							France	Euro 1	Euro 2	Euro 3	Euro 4		
VERROU A CAPOT	00000959	10	-	-	-	-	00200959	00293800 NS	00292800 NS	00294800	-	10	-

NS Non stocké/Non-stored/Producto no estocado - ☑ Sur stock Europe Zone 1 et Zone 2, nous consulter pour délai d'approvisionnement - E Epuisement/Stock depletion/Agotamiento del stock

Verrou de sûreté / ETENDARD

ECO



NIVEAU DE SÉCURITÉ



GARANTIE



X 3

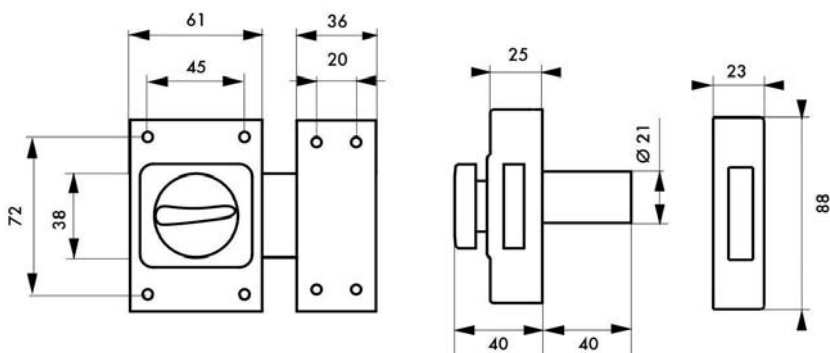

Description/Description/Descripción

Coffre acier cambré. Gâche acier cambré. Pêne acier chromé. Bouton ABS chromé. Cylindre laiton à 4 goupilles. Entrée acier zingué. 3 clés en acier nickelé.

Cambered steel case. Cambered steel striker. Chrome plated steel bolt. Chrome plated ABS knob. 4 pin brass cylinder. Zinc steel key hole plate. 3 nickel plated steel keys.

Caja de acero curvado. Cerradero de acero curvado. Pestillo de acero cromado. Botón de ABS cromado. Cilindro de latón con 4 pasadores. Entrada de acero cincado. 3 llaves de acero niquelado.

Finition/Finish/Acabado

Epoxy bronze
Bronze epoxy
Epoxi bronce

Version/Option/Versión

Double cylindre. Sans bouton.
Double cylinder. Without knob
Doble cilindro. Sin botón

Utilisation/Use/Utilización

Porte d'entrée
Entrance door
Puerta de entrada

Designation	Boite	Colis.	Prix	Sachet	Colis.	Prix	Brochable					Colis.	Prix
							France	Euro 1	Euro 2	Euro 3	Euro 4		
ETENDARD à bouton et cylindre 40 mm 3 clés	00001030	1	-	00901012	5	-	00301030	00293184 NS	00292184 NS	00294184	-	5	-
Paire ETENDARD à bton et cyl. 40 mm 6 clés	-	-	-	-	-	-	00491012	-	-	-	-	5	-
Tarif conditionnement non décollisable													
ETENDARD à bton et cyl. Ø 21 x 40 mm 3 clés en boîte 001030	00051012	30	-	-	-	-	-	-	-	-	-	-	-

NS Non stocké/Non-stored/Producto no estocado - Sur stock Europe Zone 1 et Zone 2, nous consulter pour délai d'approvisionnement - E Epuisement/Stock depletion/Agotamiento del stock

Verrou de sûreté / CONCORDE

ECO



NIVEAU DE SÉCURITÉ



GARANTIE



X 3

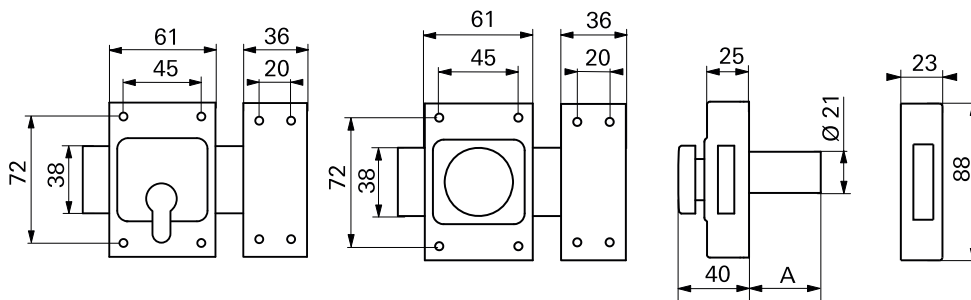

	40mm	45mm
A	40	45

Description/Description/Descripción

Coffre acier cambré. Gâche acier cambré. Pêne acier nickelé. Bouton ABS chromé. Cylindre laiton à 5 goupilles. Entrée laiton. 3 clés en acier nickelé.

Cambered steel case. Cambered steel striker. Nickel plated steel bolt. Chrome plated ABS knob. 5 pin brass cylinder. Brass key hole plate. 3 nickel plated steel keys.

Caja de acero curvado. Cerradero de acero curvado. Pestillo de acero niquelado. Botón de ABS cromado. Cilindro de latón con 5 pasadores. Entrada de latón. 3 llaves de acero niquelado

Finition/Finish/Acabado

Epoxy bronze
Bronze epoxy
Epoxi bronce

Version/Option/Versión

Double cylindre. Sans cylindre à bouton. Boitier avec pêne alliage nickelé. pour cylindre profilé.

Double cylinder. Without cylinder with knob. For profile cylinder.

Doble cilindro. Sin cilindro de botón. Caja para cilindro perfilado.

Utilisation/Use/Utilización

Porte d'entrée
Entrance door
Puerta de entrada

Designation	Boite	Colis.	Prix	Sachet	Colis.	Prix	Brochable					Colis.	Prix
							France	Euro 1	Euro 2	Euro 3	Euro 4		
CONCORDE à bouton et cylindre 40 mm 3 clés	00001010	1	-	-	-	-	00301010	-	-	-	-	5	-
CONCORDE à bouton et cylindre 45 mm 3 clés	00011010	1	-	-	-	-	00311010	-	-	-	-	5	-
Boitier CONCORDE pour cylindre profilé	00001910	1	-	-	-	-	00301910	-	-	-	-	5	-

⚠ Non stocké/Non-stored/Producto no estocado - 📦 Sur stock Europe Zone 1 et Zone 2, nous consulter pour délai d'approvisionnement - 📦 Epuisement/Stock depletion/Agotamiento del stock

Verrou de sûreté / CORVETTE

PROTECT



NIVEAU DE SÉCURITÉ



GARANTIE



X 3

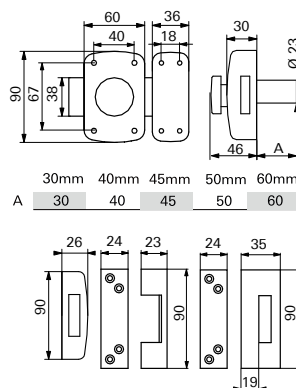

Description/Description/Descripción

Coffre et gâche acier embouti. Pêne acier nickelé. Bouton ABS chromé. Cylindre laiton à 5 goupilles. Entrée laiton. 3 clés en acier nickelé.

Pressed steel case. Pressed steel striker. Nickel plated steel bolt. Chrome plated ABS knob. 5 pin brass cylinder. Brass key hole plate. 3 nickel plated steel keys.

Caja de acero embutido. Cerradero de acero embutido. Pestillo de acero niquelado. Botón de ABS cromado. Cilindro de latón con 5 pasadores. Entrada latón. 3 llaves de acero niquelado.

Finition/Finish/Acabado

Epoxy bronze, blanc, noir, chromé
Bronze, white, black epoxy, Chrome plated
Epoxi bronce, blanco, negro, Cromado

Version/Option/Version

A double cylindre. Sans cylindre à bouton. Sans bouton. Avec pêne 160 mm cylindre 30 mm pour porte de garage.

Double cylinder. Without cylinder with knob. Without knob. With 160 mm bolt and 30 mm length. cylinder for garage door.

Doble cilindro. Sin cilindro de botón, sin botón. Patilla de retención. Con pestillo 160 mm cilindro 30 mm para puerta de garaje.

Utilisation/Use/Utilización

Porte d'entrée
Entrance door
Puerta de entrada

Designation	Boite	Colis.	Prix	Sachet	Colis.	Prix	Brochable					Colis.	Prix
							France	Euro 1	Euro 2	Euro 3	Euro 4		
CORVETTE à bton et cyl. 30 mm époxy bronze 3 clés	00003914	1	-	00903914	5	-	00303014	-	-	-	-	5	-
CORVETTE à bton et cyl. 40 mm époxy bronze 3 clés	00003010	1	-	00903010	5	-	00303010	-	-	-	-	5	-
CORVETTE à bton et cyl. 45 mm époxy bronze 3 clés	00013010	1	-	00913010	5	-	00313010	-	-	-	-	5	-
CORVETTE à bton et cyl. 50 mm époxy bronze 3 clés	00023010	1	-	00923010	5	-	00323010	-	-	-	-	5	-
CORVETTE à bton et cyl. 60 mm époxy bronze 3 clés	00043010	1	-	00943010	5	-	00343010	-	-	-	-	5	-
CORVETTE à bton et cyl. 45 mm époxy noir 3 clés	00012012 ^{NS}	1	-	00912012	5	-	00312012	-	-	-	-	5	-
CORVETTE à bton et cyl. 45 mm époxy blanc 3 clés	00012013	1	-	00912013	5	-	00312013	-	-	-	-	5	-
CORVETTE à bton et cyl. 45 mm chromé 3 clés	00003011	1	-	-	-	-	00303011	-	-	-	-	5	-
CORVETTE 45 mm pour porte à recouvrement 3 clés	00012014 ^{NS}	1	-	-	-	-	00312014	-	-	-	-	5	-
CORVETTE 45 mm pour huisserie métal 3 clés	00012015 ^{NS}	1	-	-	-	-	00312015	-	-	-	-	5	-
CORVETTE à système d'entrebaillage droite 45 mm 3 clés	-	-	-	-	-	-	00302110	-	-	-	-	5	-
CORVETTE à système d'entrebaillage gauche 45 mm 3 clés	-	-	-	-	-	-	00302210	-	-	-	-	5	-

^{NS} Non stocké/Non-stored/Producto no estocado - [□] Sur stock Europe Zone 1 et Zone 2, nous consulter pour délai d'approvisionnement - ^E Epuisement/Stock depletion/Agotamiento del stock

Verrou de sûreté / 2310

PROTECT



NIVEAU DE SÉCURITÉ



GARANTIE



X 3

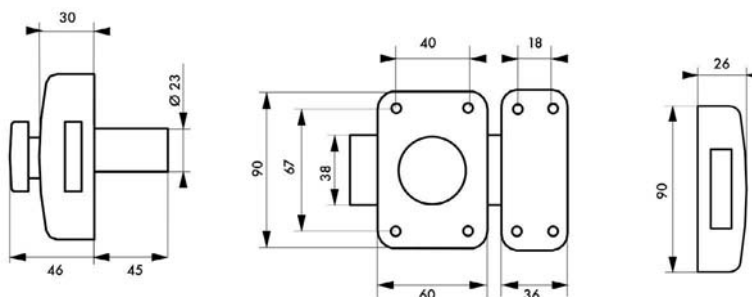

Description/Description/Descripción

Coffre en acier embouti. Gâche en acier embouti. Pêne acier chromé. Bouton ABS chromé. Cylindre laiton à 5 goupilles. Entrée laiton. 3 clés acier.

Pressed steel lock case. Pressed steel strike plate. Chrome-plated steel lock bolt. Chrome plated ABS knob.

5-pin brass cylinder. Brass key hole plate. 3 steel keys. Caja de acero embutido. Gacheta de acero embutido. Pestillo de acero cromado. Botón ABS cromado. Cilindro de latón de 5 pasadores. Entrada de latón. 3 llaves de acero.

Finition/Finish/Acabado

Epoxy bronze / *Bronze epoxy* / Epoxi bronce

Version/Option/Versión

Boîtier pour cylindre profilé

For profile cylinder

Caja para cilindro perfilado

Utilisation/Use/Utilización

Porte d'entrée / *Entrance door* / Puerta de entrada

Designation	Boite	Colis.	Prix	Sachet	Colis.	Prix	Brochable					Colis.	Prix
							France	Euro 1	Euro 2	Euro 3	Euro 4		
2310 à bouton et cylindre 45mm 3 clés	-	-	-	00902310	5	-	00302030	00293185 NS	00292185 NS	00294185	-	5	-
Paire de verrous 2310 à bouton et cylindre 45 mm 6 clés	-	-	-	-	-	-	00402310	-	-	00494591	-	5	-
Boîtier 2310 pour cylindre profilé	-	-	-	-	-	-	00202039	-	-	00294590	-	5	-
Tarif conditionnement non décollable													
2310 à bouton et cylindre Ø 23 x 45 mm 3 clés en boîte 002030	00052310	30	-	-	-	-	-	-	-	-	-	-	-
Boîtier 2310 pour cylindre profilé en boîte 002039	00032039	30	-	-	-	-	-	-	-	-	-	-	-

NS Non stocké/Non-stored/Producto no estocado - ☐ Sur stock Europe Zone 1 et Zone 2, nous consulter pour délai d'approvisionnement - ☒ Epuisement/Stock depletion/Agotamiento del stock

Verrou de sûreté / DESIGN

PROTECT



NIVEAU DE SÉCURITÉ



GARANTIE



X 3

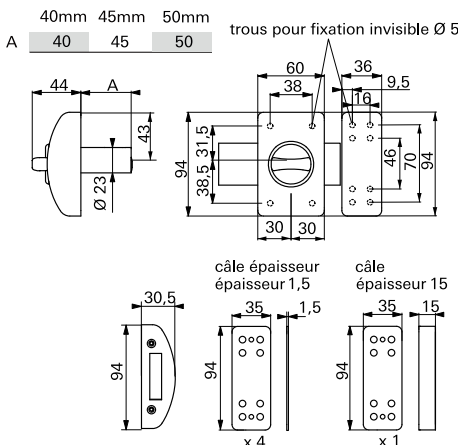

Description/Description/Descripción

Capot de coffre acier embouti. Capot de gâche acier embouti. Support de gâche et de coffre acier zingué. Pêne acier chromé. Bouton ABS chromé. Cylindre laiton à 5 goupilles. Protection contre l'arrachement du cylindre par pilier et cavalier. 3 clés en acier nickelé. Fourni avec 5 câbles de gâche pour porte à recouvrement.

Pressed steel lock case. Pressed steel strike plate. Zinc plated arched steel lock case and strike plate amount. Chrome plated finish steel lock bolt. Chrome plated ABS knob. 5 pin brass cylinder. Cylinder protected against pull out through pillar and staple. 3 nickel plated steel keys. Wedge for covering door frame.

Caja de acero embutido. Cerradero de acero embutido. Soporte de caja y gacheta de acero arqueada cincada. Pestillo de acero cromado. Boton de ABS cromada. Cilindro de laton de 5 pasadores. Proteccion contra el desgarramiento del cilindro por pilar y puente. 3 llaves de acero niquelado. Calce para puerta que recubre el marco.

Finition/Finish/Acabado

Epoxy bronze, argent, blanc, noir
Bronze, silver, white and black epoxy
Epoxi bronze, plata, blanco y negro

Utilisation/Use/Utilización

Porte d'entrée / Entrance door / Puerta de entrada

Designation	Boite	Colis.	Prix	Sachet	Colis.	Prix	Brochable					Colis.	Prix
							France	Euro 1	Euro 2	Euro 3	Euro 4		
DESIGN 5 goup. 40 mm bronze 3 clés	00071505	1	-	-	-	-	00371505	-	-	-	-	5	-
DESIGN 5 goup. 40 mm argent 3 clés	00071506	1	-	-	-	-	00371506	-	-	-	-	5	-
DESIGN 5 goup. 40 mm blanc 3 clés	00071507	1	-	-	-	-	00371507	-	-	-	-	5	-
DESIGN 5 goup. 40 mm noir 3 clés	00071508	1	-	-	-	-	00371508	-	-	-	-	5	-
DESIGN 5 goup. 45 mm bronze 3 clés	00071515	1	-	-	-	-	00371515	00293605	-	00294605	-	5	-
DESIGN 5 goup. 45 mm argent 3 clés	00071516	1	-	-	-	-	00371516	00293606	-	00294606	-	5	-
DESIGN 5 goup. 45 mm blanc 3 clés	00071517	1	-	-	-	-	00371517	00293607	-	00294607	-	5	-
DESIGN 5 goup. 45 mm noir 3 clés	00071518	1	-	-	-	-	00371518	00293608	-	00294608	-	5	-
DESIGN 5 goup. 50 mm bronze 3 clés	00071525	1	-	-	-	-	00371525	00293609	-	-	-	5	-
DESIGN 5 goup. 50 mm argent 3 clés	00071526	1	-	-	-	-	00371526	-	-	-	-	5	-
DESIGN 5 goup. 50 mm blanc 3 clés	00071527	1	-	-	-	-	00371527	-	-	-	-	5	-
DESIGN 5 goup. 50 mm noir 3 clés	00071528	1	-	-	-	-	00371528	-	-	-	-	5	-

Non stocké/Non-stored/Producto no estocado - Sur stock Europe Zone 1 et Zone 2, nous consulter pour délai d'approvisionnement - Epuisement/Stock depletion/Agotamiento del stock

Verrou de sûreté / UNIVERSEL PROTECT



NIVEAU DE SÉCURITÉ



GARANTIE



X 3



Pose facile et rapide dans les trous existants à l'aide d'un seul tournevis

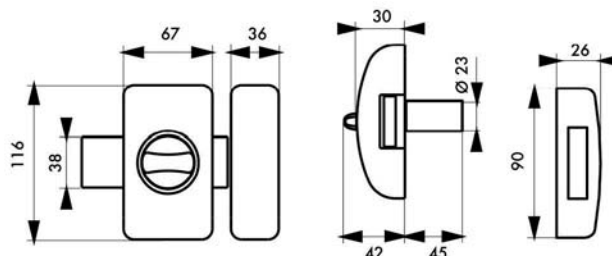
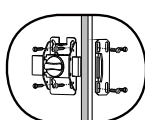

Description/Description/Descripción

Supports de coffre et gâche en acier cambré zingué. Capots de coffre et gâche en alliage. Pêne acier chromé satin. Bouton à barrette ABS chromé satin. Cylindre laiton 5 goupilles. Protection contre l'arrachement du cylindre par pilier et cavalier. Entrée laiton. 3 clés laiton nickelé. Possibilité : Clés même variure (sur demande).
Zinc plated arched steel lock case and strike plate mount. Alloy lock case and strike plate cover. Chrome-plated satin finish steel lock bolt. Chrome-plated satin finish ABS knob with small bars. 5 pin brass cylinder. Cylinder protected against pull out through pillar and staple. Brass backset. 3 nickel-plated brass keys. Finish

Soporte de caja y gacheta de acero arqueado cincado. Capó de caja y gacheta de aleación. Pestillo de acero cromado satin. Botón con barra ABS cromada satin. Cilindro de latón de 5 pasadores. Protección contra el desgarramiento del cilindro por pilar y puente. Entrada de latón. 3 llaves de latón niquelado.

Finition/Finish/Acabado

Epoxy bronze, argent, noir, blanc
Bronze, silver, black, and white epoxy
Epoxi bronce, plata, negro, blanco

Utilisation/Use/Utilización

Porte d'entrée / Entrance door / Puerta de entrada

Designation	Boite	Colis.	Prix	Sachet	Colis.	Prix	Brochable					Colis.	Prix
							France	Euro 1	Euro 2	Euro 3	Euro 4		
UNIVERSEL 5 goup. 45 mm bronze 3 clés	00090545	1	-	-	-	-	00390545	-	-	-	-	2	-
UNIVERSEL 5 goup. 45 mm argent 3 clés	00090546	1	-	-	-	-	00390546	-	-	-	-	2	-
UNIVERSEL 5 goup. 45 mm blanc 3 clés	00090547	1	-	-	-	-	00390547	-	-	-	-	2	-
UNIVERSEL 5 goup. 45 mm noir 3 clés	00090548	1	-	-	-	-	00390548	-	-	-	-	2	-

⚠ Non stocké/Non-stored/Producto no estocado - 📦 Sur stock Europe Zone 1 et Zone 2, nous consulter pour délai d'approvisionnement - 📦 Epuisement/Stock depletion/Agotamiento del stock

Verrou de sûreté / UNIVERSEL A LANGUETTE

PROTECT



NIVEAU DE SÉCURITÉ



GARANTIE



X 3

Cylindre ajustable à languette de 35 à 80mm



Remplace les verrous existants, sans nouveau perçage

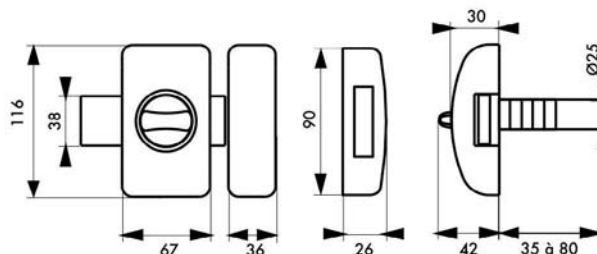

Description/Description/Descripción

Supports de coffre et gâche en acier cambré zingué. Capots de coffre et gâche en alliage. Pêne acier chromé satin. Bouton à barrette ABS chromé satin. Cylindre laiton à languette 5 goupilles. Entrée laiton. 3 clés laiton nickelé. Possibilité : Clés même variure (sur demande).
Zinc plated arched steel lock case and strike plate mount. Alloy lock case and strike plate cover. Chrome-plated satin finish steel lock bolt. Chrome-plated satin finish ABS knob with small bars. 5 pin brass cylinder. Brass backset. 3 nickel-plated brass keys.

Soporte de caja y gacheta de acero arqueado cincado. Capó de caja y gacheta de aleación. Pestillo de acero cromado satén. Botón con barra ABS cromada satén. Cilindro de latón de 5 pasadores. Entrada de latón. 3 llaves de latón niquelado.

Finition/Finish/Acabado

Epoxy bronze, argent, noir, blanc
Bronze, silver, black, and white epoxy

Utilisation/Use/Utilización

Porte d'entrée
Entrance door
 Puerta de entrada

Designation	Boite	Colis.	Prix	Sachet	Colis.	Prix	Brochable					Colis.	Prix
							France	Euro 1	Euro 2	Euro 3	Euro 4		
UNIVERSEL HG5 à languette 45 mm bronze 3 clés	00080470	1	-	-	-	-	00380470	-	-	-	-	2	-
UNIVERSEL HG5 à languette 45 mm argent 3 clés	00080471	1	-	-	-	-	00380471	-	-	-	-	2	-
UNIVERSEL HG5 à languette 45 mm blanc 3 clés	00080472	1	-	-	-	-	00380472	-	-	-	-	2	-
UNIVERSEL HG5 à languette 45 mm noir 3 clés	00080473	1	-	-	-	-	00380473	-	-	-	-	2	-

Non stocké/Non-stored/Producto no estocado - Sur stock Europe Zone 1 et Zone 2, nous consulter pour délai d'approvisionnement - Epuement/Stock depletion/Agotamiento del stock

Verrou de sûreté / UNIVERSEL A LANGUETTE

PROTECT



NIVEAU DE SÉCURITÉ



GARANTIE



X 5

Cylindre ajustable à languette de 35 à 80mm



Remplace les verrous existants, sans nouveau perçage



Un tournevis suffit !

Pose facile et rapide dans les trous existants à l'aide d'un seul tournevis

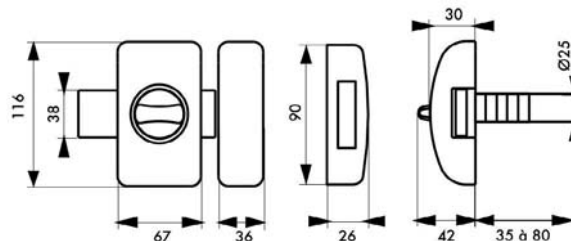

Description/Description/Descripción

Supports de coffre et gâche en acier cambré zingué. Capots de coffre et gâche en alliage. Pêne acier chromé satin. Bouton à barrette ABS chromé satin. Cylindre laiton à languette de 5 goupilles. Protection contre le perçage par première goupille en acier trempé. Billes anti-crochetage interne au cylindre interdisant toute reproduction hors usine. Entrée laiton. 5 clés laiton nickelé avec carte de propriété. Possibilité : Clés même variure (sur demande). Zinc plated arched steel lock case and strike plate mount. Alloy lock case and strike plate cover. Chrome-plated satin finish steel lock bolt. Chrome-plated satin finish ABS knob with small bars. 5 pins brass cylinder. Protection against drilling through a first hardened steel pin. Balls anti-picking internal cylinder prohibiting any reproduction. Brass backset. 5 nickel-plated brass keys with personal security card.

Soporte de caja y gacheta de acero arqueado cincado. Capó de caja y gacheta de aleación. Pestillo de acero cromado satin. Botón con barra ABS cromada satin. Cilindro de latón de 5 pistones. Protección contra la perforación por primer pasador de acero templado. Bolas anti-forzado internas al cilindro que prohíben cualquier reproducción fuera de fábrica. Entrada de latón. 5 llaves de latón niquelado patentadas con título de propiedad.

Finition/Finish/Acabado

Epoxy bronze, argent, noir, blanc
Bronze, silver, black, and white epoxy
Epoxi bronce, plata, negro, blanco

Utilisation/Use/Utilización

Porte d'entrée
Entrance door
Puerta de entrada

Designation	Boite	Colis.	Prix	Sachet	Colis.	Prix	Brochable					Colis.	Prix
							France	Euro 1	Euro 2	Euro 3	Euro 4		
UNIVERSEL HG5+ à languette 45 mm bronze 5 clés	00080480	1	-	-	-	-	00380480	-	-	-	-	2	-
UNIVERSEL HG5+ à languette 45 mm argent 5 clés	00080481	1	-	-	-	-	00380481	-	-	-	-	2	-
UNIVERSEL HG5+ à languette 45 mm blanc 5 clés	00080482	1	-	-	-	-	00380482	-	-	-	-	2	-
UNIVERSEL HG5+ à languette 45 mm noir 5 clés	00080483	1	-	-	-	-	00380483	-	-	-	-	2	-

⚠ Non stocké/Non-stored/Producto no estocado - 📦 Sur stock Europe Zone 1 et Zone 2, nous consulter pour délai d'approvisionnement - 📦 Epuisement/Stock depletion/Agotamiento del stock

Verrou multipoints / MIRAGE 6

PROTECT



NIVEAU DE SÉCURITÉ



GARANTIE



X 3

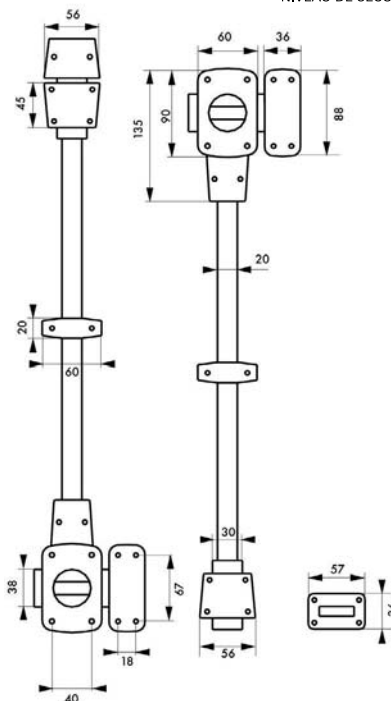
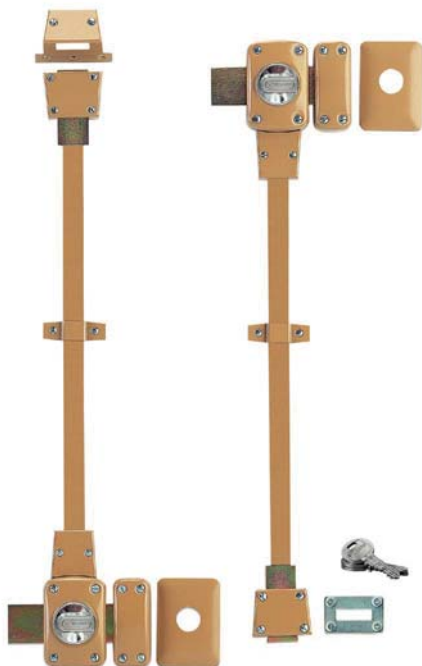

Description/Description/Descripción

Coffre acier embouti. Gâche acier embouti. Pênes acier chromé. Bouton à barette ABS chromé. Cylindre laiton à 5 goupilles 45 mm. Tringles en acier. 2 points 1x460 mm. 4 points 2x460 mm. 1 Plaque de renfort par verrou. 3 clés en acier nickelé.

Pressed steel case and striker. Chrome plated steel bolts. Chrome plated ABS knob. 5 pin brass double cylinder 45 mm length. Aluminium rods. Strengthening plate. 3 nickel plated steel keys.

Caja de acero embutido. Cerradero de acero embutido. Pestillos de acero cromado. Botón con horquilla de ABS cromado. Doble cilindro de latón con 5 pasadores de 45 mm. Trancas de aluminio. Placa de refuerzo. 3 llaves de acero niquelado.

Finition/Finish/Acabado

Epoxy bronze

Bronze epoxy

Epoxi bronce

Version/Option/Versión

Double cylindre. Droite - Gauche - Haut et côté. Bas et côté. Paire de verrous haut et côté / bas et côté.

Double cylinder. Right hand. Left hand. Top and side bolting. Down and side bolting. Pair of bolts top and side / down and side bolting.

Doble cilindro. Derecha. Izquierda. Alto y lado. Bajo y lado. Par de cerrojos alto y lado / bajo y lado.

Utilisation/Use/Utilización

Porte d'entrée

Entrance door

Puerta de entrada

Designation	Boite	Colis.	Prix	Sachet	Colis.	Prix	Brochable					Colis.	Prix
							France	Euro 1	Euro 2	Euro 3	Euro 4		
Paire de verrous MIRAGE 6 bouton et cylindre 45 mm 4 points droite	00010110	1	-	-	-	-	-	-	-	-	-	-	-
MIRAGE 6 • 2 points à bouton et cyl. 45 mm haut et côté droite	00021110	1	-	-	-	-	-	-	-	-	-	-	-
MIRAGE 6 • 2 points à bouton et cyl. 45 mm haut et côté gauche	00021210	1	-	-	-	-	-	-	-	-	-	-	-
MIRAGE 6 • 2 points à bouton et cylindre 45 mm bas et côté droite	00022110	1	-	-	-	-	-	-	-	-	-	-	-
MIRAGE 6 • 2 points à bouton et cylindre 45 mm bas et côté gauche	00022210	1	-	-	-	-	-	-	-	-	-	-	-

Non stocké/Non-stored/Producto no estocado - Sur stock Europe Zone 1 et Zone 2, nous consulter pour délai d'approvisionnement - Epuement/Stock depletion/Agotamiento del stock

Verrou multipoints / MIRAGE 6

PROTECT



NIVEAU DE SÉCURITÉ



GARANTIE



X 3

Verrou multipoints complément idéal pour une serrure à encastrer ou applique 1 point.

Description/Description/Descripción

Coffre acier embouti. Gâche acier embouti. Pênes acier zingué. Bouton à barrette ABS chromé. Cylindre laiton à 5 goupilles 45 mm. Tringles en acier 1x500 + 1x1500 mm. Plaque de renfort. Coulisseau de passage pour serrure horizontale. 3 clés en acier nickelé.

Pressed steel case and striker. d zinc plated plated steel bolts. Chrome plated ABS knob. 5 pin brass double cylinder 45 mm length. Aluminium rods. Strengthening plate. Mechanism to be used for horizontal lock. 3 nickel plated steel keys.

Caja de acero embutido. Cerradero de acero embutido. Pestillos de acero cincado. Botón con horquilla de ABS cromado. Cilindro de latón con 5 pasadores 45 mm. Trancas de aluminio. Placa de refuerzo. Corredera de paso para cerradura horizontal. 3 llaves de acero niquelado.

Finition/Finish/Acabado

Epoxy bronze

Bronze epoxy

Epoxi bronce

Version/Option/Versión

Double cylindre. Droite - Gauche.

Double cylinder. Right hand. Left hand.

Doble cilindro. Derecha. Izquierda.

Utilisation/Use/Utilización

Porte d'entrée

Entrance door

Puerta de entrada

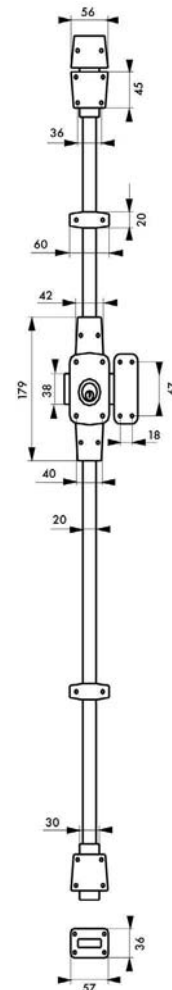

Designation	Boite	Colis.	Prix	Sachet	Colis.	Prix	Brochable					Colis.	Prix
							France	Euro 1	Euro 2	Euro 3	Euro 4		
MIRAGE 6 bton et cyl. haut et bas droite 3 clés	00030110	1	-	-	-	-	-	-	-	-	-	-	-
MIRAGE 6 bton et cyl. haut et bas gauche 3 clés	00030210	1	-	-	-	-	-	-	-	-	-	-	-
Point supplémentaire pour verrou droit	00030001 NS	1	-	-	-	-	-	-	-	-	-	-	-
Point supplémentaire pour verrou gauche	00030011 NS	1	-	-	-	-	-	-	-	-	-	-	-
Tringle de 0,50 m	00030002	1	-	-	-	-	-	-	-	-	-	-	-
Tringle de 1,00 m	00030003	1	-	-	-	-	-	-	-	-	-	-	-
Tringle de 1,50 m	00030004	1	-	-	-	-	-	-	-	-	-	-	-

NS Non stocké/Non-stored/Producto no estocado - S Sur stock Europe Zone 1 et Zone 2, nous consulter pour délai d'approvisionnement - E Epuisement/Stock depletion/Agotamiento del stock

Verrou de haute sûreté / ADRIATIC 2

PROTECT



NIVEAU DE SÉCURITÉ



GARANTIE



X 4



Clés brevetées et protection contre le crochetage et le perçage.



Foncet vissé démontable

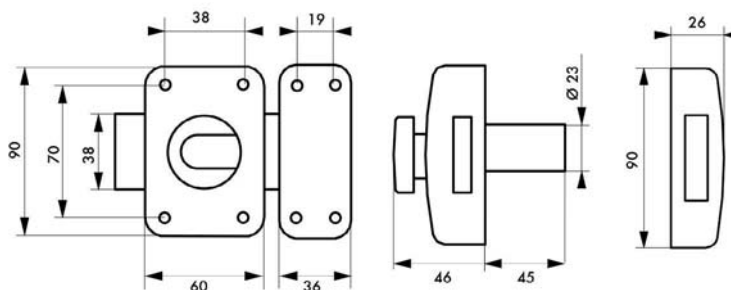

Description/Description/Descripción

Coffre en acier embouti. Gâche en acier embouti. Pêne acier chromé satin. Bouton ABS chromé satin. Cylindre laiton de 6 à 22 goupilles maillechort sur 5 rangées. Goupilles anti-crochetage. Protection contre le perçage par première goupille en acier trempé. Protection contre l'arrachement du cylindre par pilier et cavalier. 4 clés laiton nickelé avec insert ABS, avec carte de propriété permettant la reproduction des clés exclusivement en usine. Pièce mobile anti-crochetage interne. au cylindre interdisant toute reproduction hors usine.

Pressed steel lock case. Pressed steel strike plate. Satin chrome-plated finish steel lock bolt. Satin chrome-plated finish ABS knob. Brass cylinder with 6 to 22 nickel silver pins on 5 rows. Anti-picking pins. Protection against drilling through a first hardened steel pin. Cylinder protected against pull out through pillar and staple. 4 nickel-plated brass keys with ABS insert and property card allowing exclusive key reproduction in the factory. Anti-picking moving part inside cylinder that prohibit any reproduction off factory.

Caja de acero embutido. Gacheta de acero embutido. Pestillo de acero cromado satin. Botón ABS cromado satin. Cilindro de latón de 6 a 22 pasadores maillechort sobre 5 hileras. Pasadores anti-forzado. Protección contra la perforación por primer pasador de acero templado. Protección contra el desgarramiento del cilindro por pilar y puente. 4 llaves de latón niquelado con inserto ABS y tarjeta de propiedad que permite la reproducción de las llaves exclusivamente en fábrica.

Finition/Finish/Acabado

Epoxy or
Gold epoxy
Epoxi dorado

Versión/Option/Versión

Double cylindre
Double cylinder
Doble cilindro

Utilisation/Use/Utilización

Porte d'entrée
Entrance door
Puerta de entrada

Designation	Boîte	Colis.	Prix	Sachet	Colis.	Prix	Brochable					Colis.	Prix
							France	Euro 1	Euro 2	Euro 3	Euro 4		
ADRIATIC 2 à bouton et cyl. à goupilles 45 mm 4 clés	00090513	-	-	-	-	-	00390513	-	-	-	-	2	-

Non stocké/Non-stored/Producto no estocado - Sur stock Europe Zone 1 et Zone 2, nous consulter pour délai d'approvisionnement - Epuement/Stock depletion/Agotamiento del stock

Verrou de haute sûreté / TRAFIC 6

PROTECT



NIVEAU DE SÉCURITÉ



GARANTIE



X 4



Foncet vissé démontable

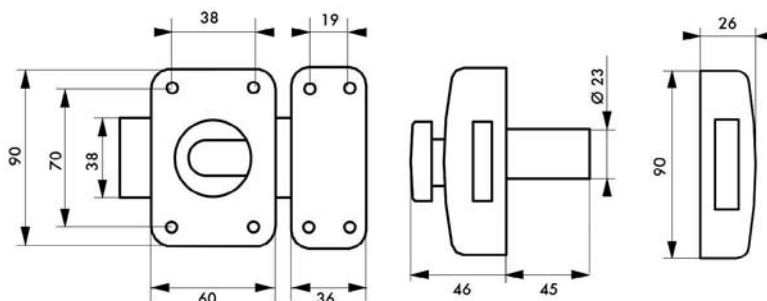

Description/Description/Descripción

Coffre en acier embouti. Gâche en acier embouti. Pêne acier chromé. Bouton ABS chromé. Cylindre laiton à 6 goupilles. Protection contre le perçage par première goupille en acier trempé. Goupilles anti-crochetage. Protection contre l'arrachement du cylindre par pilier et cavalier. 4 clés plates réversibles laiton nickelé avec carte de propriété.

Pressed steel lock case. Pressed steel strike plate. Chrome-plated steel lock bolt. Chrome-plated ABS knob. 6-pin brass cylinder. Protection against drilling by hardened steel pin. Anti-picking pins. Cylinder protected against pull out through pillar and staple. 4 nickel-plated brass reversible. cylinder keys with personal card.

Caja de acero embutido. Gacheta de acero embutido. Pestillo de acero cromado. Botón ABS cromado. Cilindro de latón de 6 pasadores. Protección contra el taladrado por el primer pasador de acero templado. Pasadores anti-forzado. Protección contra el desgarramiento del cilindro por pilar y puente. 4 llaves planas reversibles de latón. niquelado con tarjeta persona.

Finition/Finish/Acabado

Epoxy or
Gold epoxy
Epoxi dorado

Versión/Option/Versión

Double cylindre
Double cylinder
Doble cilindro

Utilisation/Use/Utilización

Porte d'entrée
Entrance door
Puerta de entrada

Designation	Boite	Colis.	Prix	Sachet	Colis.	Prix	Brochable					Colis.	Prix
							France	Euro 1	Euro 2	Euro 3	Euro 4		
TRAFIC 6 à bouton et cyl. à goupilles 45 mm 4 clés réversibles	00090502	1	-	00990502	10	-	00290502	-	-	-	-	2	-

⚠ Non stocké/Non-stored/Producto no estocado - 📦 Sur stock Europe Zone 1 et Zone 2, nous consulter pour délai d'approvisionnement - 📦 Epuisement/Stock depletion/Agotamiento del stock

Verrou de haute sûreté / UNIVERSEL

PROTECT



NIVEAU DE SÉCURITÉ



GARANTIE



X 4

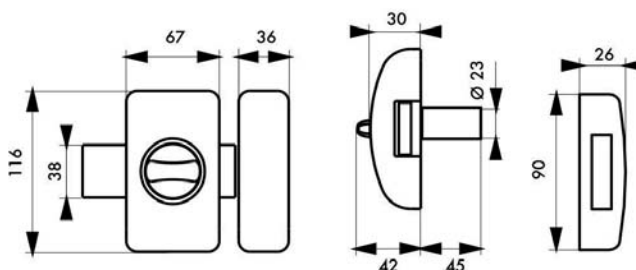

Description/Description/Descripción

Supports de coffre et gâche en acier cambré zingué. Capots de coffre et gâche en alliage. Pêne acier chromé satin. Bouton à barrette ABS chromé satin. Cylindre laiton 6 goupilles. Goupilles anti-crochetage. Protection contre le perçage par première goupille en acier trempé. Protection contre l'arrachement du cylindre par pilier et cavalier. Entrée laiton. 4 clés plates laiton nickelé réversibles avec carte de propriété.

Zinc plated arched steel lock case and strike plate mount. Alloy lock case and strike plate cover. Chrome-plated satin finish steel lock bolt. Chrome-plated satin finish ABS knob with small bars. Cylinder protected against pull out through pillar and staple. Brass backset. 6 pin brass cylinder. Anti-picking pins. Protection against drilling through a first hardened steel pin. 4 reversible nickel-plated brass cylinder keys with personal card.

Soporte de caja y gacheta de aleación. arqueada cincada. Capó de caja y gacheta de aleación. Pestillo de acero

cromado satiné. Botón con barra ABS cromada satiné. Protección contra el desgarramiento del cilindro por pilar y puente. Entrada de latón. Cilindro de latón de 6 pasadores. Pasadores anti-forzado. Protección contra la perforación por primer pasador de acero templado. 4 llaves planas de latón niquelado reversibles con tarjeta personal.

Finition/Finish/Acabado

Epoxy bronze, argent, noir, blanc
Bronze, silver, black, and white epoxy
Epoxi bronce, plata, negro, blanco

Version/Option/Versión

Double cylindre
Double cylinder
Doble cilindro

Utilisation/Use/Utilización

Porte d'entrée
Entrance door
Puerta de entrada

Designation	Boite	Colis.	Prix	Sachet	Colis.	Prix	Brochable					Colis.	Prix
							France	Euro 1	Euro 2	Euro 3	Euro 4		
UNIVERSEL 6 goup. 45 mm bronze 4 clés réversibles	00081451	1	-	-	-	-	00380451	00393188 NS	00392188 NS	00394188	-	2	-
UNIVERSEL 6 goup. 45 mm argent 4 clés réversibles	00080452	1	-	-	-	-	00380452	00393189 NS	-	00394189	-	2	-
UNIVERSEL 6 goup. 45 mm blanc 4 clés réversibles	00081453	1	-	-	-	-	00380453	00393190 NS	-	00394190	-	2	-
UNIVERSEL 6 goup. 45 mm noir 4 clés réversibles	00080454	1	-	-	-	-	00380454	00393191 NS	-	00394191	-	2	-

NS Non stocké/Non-stored/Producto no estocado - Sur stock Europe Zone 1 et Zone 2, nous consulter pour délai d'approvisionnement - E Epuement/Stock depletion/Agotamiento del stock

Verrou de sûreté / UNIVERSEL A LANGUETTE

PROTECT



NIVEAU DE SÉCURITÉ



MODÈLE DÉPOSÉ PROTÉGÉ



GARANTIE



X 5

Cylindre ajustable à languette de 35 à 80mm



Remplace les verrous existants, sans nouveau perçage



Un tournevis suffit !



Pose facile et rapide dans les trous existants à l'aide d'un seul tournevis

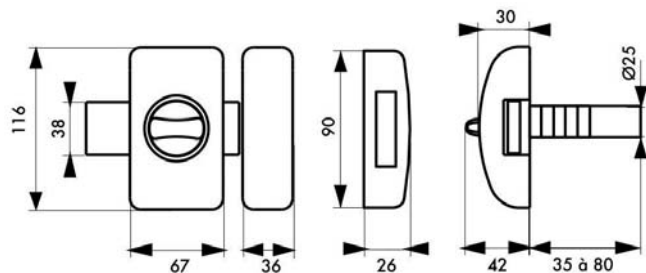

Description/Description/Descripción

Supports de coffre et gâche en acier cambré zingué. Capots de coffre et gâche en alliage. Pêne acier chromé satin. Bouton à barrette ABS chromé satin. Cylindre laiton à languette 8 goupilles. Protection contre le perçage par première goupille en acier trempé. Entrée laiton. 5 clés plates laiton nickelé réversibles avec carte de propriété. Zinc plated arched steel lock case and strike plate mount. Alloy lock case and strike plate cover. Chrome-plated satin finish steel lock bolt. Chrome-plated satin finish ABS knob with small bars. Brass backset. 8 pins brass cylinder. Anti-picking pins. Protection against drilling through a first hardened steel pin. 5 reversible nickel-plated brass cylinder keys with personal card. Soporte de caja y gacheta de acero. arqueada cincada.

Capó de caja y gacheta de aleación. Pestillo de acero cromado satin. Botón con barra ABS cromada satin. Protección contra el desgarramiento del cilindro por pilar y puente. Entrada de latón. Cilindro de latón de 8 pasadores. Protección contra la perforación por primer pasador de acero templado. 5 llaves planas de latón niquelado reversibles con tarjeta personal.

Finition/Finish/Acabado

Epoxy bronze, argent, blanc, noir
Bronze, silver, white and black epoxy
Epoxi bronze, plata, blanco y negro

Utilisation/Use/Utilización

Porte d'entrée
Entrance door
Puerta de entrada

Designation	Boite	Colis.	Prix	Sachet	Colis.	Prix	Brochable					Colis.	Prix
							France	Euro 1	Euro 2	Euro 3	Euro 4		
UNIVERSEL TRANSIT 2 à languette 45 mm bronze 5 clés	00080440	1	-	-	-	-	00380440	-	-	-	-	2	-
UNIVERSEL TRANSIT 2 à languette 45 mm argent 5 clés	00080441	1	-	-	-	-	00380441	-	-	-	-	2	-
UNIVERSEL TRANSIT 2 à languette 45 mm blanc 5 clés	00080422	1	-	-	-	-	00380442	-	-	-	-	2	-
UNIVERSEL TRANSIT 2 à languette 45 mm noir 5 clés	00080443	1	-	-	-	-	00380443	-	-	-	-	2	-

⚠ Non stocké/Non-stored/Producto no estocado - 📦 Sur stock Europe Zone 1 et Zone 2, nous consulter pour délai d'approvisionnement - 📦 Epuisement/Stock depletion/Agotamiento del stock

Verrou de sûreté / APACHE

RESIST



NIVEAU DE SÉCURITÉ



GARANTIE

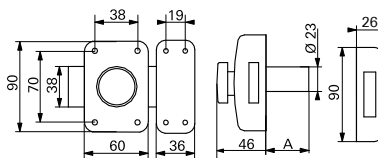

	30mm	40mm	45mm	50mm	60mm
A	30	40	45	50	60

Description/Description/Descripción

Coffre en acier embouté. Gâche en acier embouté. Pêne acier chromé. Bouton ABS mat. Cylindre laiton à 5 goupilles. Protection contre l'arrachement du cylindre par pilier et cavalier (sauf cylindre de 30 mm). Pêne interchangeable. Entrée laiton. 3 clés acier.

Pressed steel lock case. Pressed steel strike plate. Chrome-plated steel lock bolt. Dull ABS knob. 5-pin brass cylinder. Cylinder protected against pull out through pillar and staple (except cylinder 30 mm). Brass key hole plate. 3 steel keys.

Caja de acero embutido. Gacheta de acero embutido. Pestillo de acero cromado. Botón ABS mate. Cilindro de latón de 5 pasadores. Protección contra el desgarramiento del cilindro por pilar y caballero (excepto cilindro 30 mm). Entrada de latón. 3 llaves de acero.

Finition/Finish/Acabado

Epoxy or
Gold epoxy
Epoxi dorado

Versión/Option/Versión

Double cylindre. Avec pêne 160 mm Cylindre 30 mm pour porte de garage. Sans cylindre extérieur. Pour cylindre profilé. Pêne 140 mm pour porte à recouvrement

Double cylinder. With 160 mm bolt and 30 mm length cylinder for garage door. Without outside cylinder. Bolt 140 mm for covering door frame.

Doble cilindro. Con pestillo 160 mm cilindro 30 mm para puerta de garaje. Sin cilindro exterior. Pestillo 140 mm para puerta que recubre el marco.

Utilisation/Use/Utilización

Porte d'entrée
Entrance door
Puerta de entrada



X 3



Designation	Boite	Colis.	Prix	Sachet	Colis.	Prix	Brochable					Colis.	Prix
							France	Euro 1	Euro 2	Euro 3	Euro 4		
APACHE à bouton et cylindre 30 mm époxy or 3 clés	-	-	-	00990531	5	-	00290531	-	-	-	-	5	-
APACHE à bouton et cylindre 40 mm époxy or 3 clés	-	-	-	00990541	5	-	00290541	-	-	-	-	5	-
APACHE à bouton et cylindre 45 mm époxy or 3 clés	-	-	-	00990501	5	-	00290501	00293186	-	00294186	-	5	-
APACHE à bton et cylindre 45 mm blanc 3 clés	-	-	-	00990521	5	-	00290521	-	-	-	-	5	-
APACHE à bton et cylindre 45 mm noir 3 clés	-	-	-	00990511	5	-	00290511	-	-	-	-	5	-
APACHE à bton et cylindre 45 mm huisserie métallique 3 clés	-	-	-	-	-	-	00290581	-	-	-	-	5	-
APACHE à bouton et cylindre 45 mm gâche à encastrer 3 clés	-	-	-	-	-	-	00290591	-	-	-	-	5	-
APACHE à bton et cyl. 40 mm pêne 140mm pour porte à recouvrement	-	-	-	-	-	-	00490511	-	-	-	-	5	-
APACHE à bouton et cylindre 45 mm avec plaque de renfort	-	-	-	-	-	-	00390571	-	-	-	-	5	-
APACHE à bouton et cylindre 50 mm époxy or 3 clés	-	-	-	00990551	5	-	00290551	-	-	-	-	5	-
APACHE à bouton et cylindre 60 mm époxy or 3 clés	-	-	-	00990561	5	-	00290561	-	-	-	-	5	-
Boitier APACHE à cylindre profilé époxy blanc	-	-	-	00903912	5	-	00203912	-	-	-	-	5	-
Paire APACHE à bouton et cyl. 45 mm époxy or 6 clés	-	-	-	-	-	-	00490521	-	-	-	-	5	-

Non stocké/Non-stored/Producto no estocado - Sur stock Europe Zone 1 et Zone 2, nous consulter pour délai d'approvisionnement - Epuisement/Stock depletion/Agotamiento del stock

Verrou de sûreté / RAFALE

RESIST



NIVEAU DE SÉCURITÉ



GARANTIE



X 3

Verrou double fixation brevettée pour une protection contre larrachement

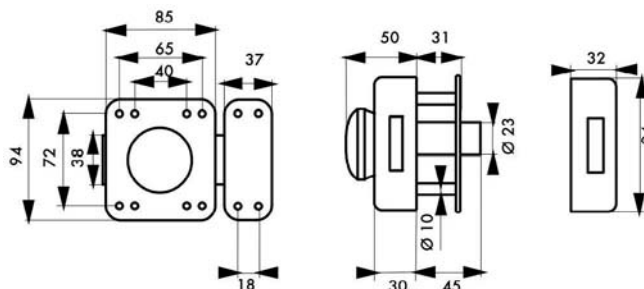

Description/Description/Descripción

Coffre acier embouti. Gâche acier embouti. Pêne acier nickelé. Bouton ABS nickelé mat. Mécanisme intérieur renforcé (brevet déposé). Double fixation sur coffre à 8 vis (brevet déposé). Plaque de renfort. Cylindre laiton à 5 goupilles. Entrée laiton. 3 clés en acier nickelé.

Pressed steel case and striker. Dull nickel plated ABS knob. Nickel plated steel bolt. Strong inner mechanism (patent registered). Double fixing with 8 screws on case (patent registered). Strengthening plate. 5 pin brass cylinder. Brass key hole plate. 3 nickel plated steel keys.
Caja de acero embutido. Cerradero de acero embutido. Pestillo de acero niquelado. Botón de ABS niquelado mate. Mecanismo interior reforzado (patente registrada). Doble fijación en caja con 8 tornillos (patente registrada). Placa de refuerzo.

Finition/Finish/Acabado

Epoxy bronze, blanc
Bronze or white epoxy
Epoxi bronce, blanco

Version/Option/Versión

A double cylindre
Double cylinder
Doble cilindro

Utilisation/Use/Utilización

Porte d'entrée
Entrance door
Puerta de entrada

Designation	Boite	Colis.	Prix	Sachet	Colis.	Prix	Brochable					Colis.	Prix
							France	Euro 1	Euro 2	Euro 3	Euro 4		
RAFALE à bouton et cylindre 45 mm époxy bronze 3 clés	00005010	1	-	-	-	-	-	-	-	-	-	-	-
Boitier RAFALE à cylindre profilé époxy bronze	00003039	1	-	-	-	-	-	-	-	-	-	-	-
Boitier RAFALE à cylindre profilé époxy blanc	00003038	1	-	-	-	-	-	-	-	-	-	-	-

Ⓜ Non stocké/Non-stored/Producto no estocado - Ⓜ Sur stock Europe Zone 1 et Zone 2, nous consulter pour délai d'approvisionnement - Ⓜ Epuisement/Stock depletion/Agotamiento del stock

Verrou de haute sûreté / TRANSIT 2

RESIST



Foncet vissé
démontable



NIVEAU DE SÉCURITÉ

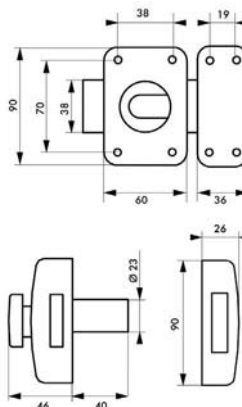

GARANTIE



X 4

Description/Description/Descripción

Coffre en acier embouti. Gâche en acier embouti. Pêne acier chromé. Bouton ABS chromé. Cylindre à 8 goupilles maillechort. Protection contre le perçage par première goupille en acier trempé. Protection contre l'arrachement par pilier et cavalier. 4 clés plates laiton nickelé réversibles avec carte de propriété, permettant la reproduction des clés exclusivement en usine.

Pressed steel case and striker. Chrome plated steel bolt. Chrome plated ABS knob. 6 pin brass cylinder. Protection against drilling by hardened steel pin. Safety device against drawing the cylinder by rider and pillar. 4 nickel plated brass reversible keys with owner card allowing key duplication in factory.

Caja de acero embutido. Cerradero de acero embutido. Pestillo de acero cromado. Botón de ABS cromado.

Cilindro de 6 pasadores de alpaca. Protección contra el taladrado por el primer pasador de acero templado. Protección contra el arrancamiento por pilar y puente. 4 llaves de latón niquelado reversibles con tarjeta de propiedad para la reproducción de las llaves en fábrica.

Finition/Finish/Acabado

Epoxy or
Gold epoxy

Epoxi dorado

Version/Option/Versión

Double cylindre

Double cylinder

Doble cilindro

Utilisation/Use/Utilización

Porte d'entrée / Entrance door / Puerta de entrada

Designation	Boîte	Colis.	Prix	Sachet	Colis.	Prix	Brochable					Colis.	Prix
							France	Euro 1	Euro 2	Euro 3	Euro 4		
TRANSIT 2 à bouton et cylindre 40 mm époxy or 3 clés	00007610	1	-	-	-	-	-	-	-	-	-	-	-
TRANSIT 2 à bouton et cylindre 45 mm époxy or 3 clés	00017610	1	-	00917610	10	-	00317610	-	-	-	-	2	-
TRANSIT 2 à bouton et cylindre 50 mm époxy or 3 clés	00027610	1	-	-	-	-	-	-	-	-	-	-	-
TRANSIT 2 à bouton et cylindre 60 mm époxy or 3 clés	00047610	1	-	-	-	-	-	-	-	-	-	-	-
TRANSIT 2 à bouton et cylindre 65 mm époxy or 3 clés	00057610	1	-	-	-	-	-	-	-	-	-	-	-
TRANSIT 2 à bouton et cylindre 70 mm époxy or 3 clés	00067610	1	-	-	-	-	-	-	-	-	-	-	-
TRANSIT 2 à bouton et cylindre 75 mm époxy or 3 clés	00077610	1	-	-	-	-	-	-	-	-	-	-	-
TRANSIT 2 à bouton et cylindre 80 mm époxy or 3 clés	00087610	1	-	-	-	-	-	-	-	-	-	-	-
TRANSIT 2 à bouton et cylindre 85 mm époxy or 3 clés	00097610 NS	1	-	-	-	-	-	-	-	-	-	-	-
TRANSIT 2 à bouton et cylindre 90 mm époxy or 3 clés	00117610 NS	1	-	-	-	-	-	-	-	-	-	-	-
TRANSIT 2 à bouton et cylindre 95 mm époxy or 3 clés	00127610 NS	1	-	-	-	-	-	-	-	-	-	-	-
TRANSIT 2 à bouton et cylindre 100 mm époxy or 3 clés	00137610 NS	1	-	-	-	-	-	-	-	-	-	-	-

NS Non stocké/Non-stored/Producto no estocado - Sur stock Europe Zone 1 et Zone 2, nous consulter pour délai d'approvisionnement - E Epuement/Stock depletion/Agotamiento del stock

Verrou de sûreté / CAPITAL RESIST



NIVEAU DE SÉCURITÉ



GARANTIE



X 3



Foncet vissé
démontable

Description/Description/Descripción

Coffre et gâche acier embouti. Pêne acier chromé mat. Bouton ABS chromé mat. Cylindre laiton à 5 goupilles type HG5. Protection contre l'arrachement du cylindre par pilier et cavalier (sauf cylindre de 30 mm). Pêne interchangeable. Entrée laiton - 3 clés en acier nickelé.

Pressed steel case. Pressed steel striker. Dull chrome plated ABS knob. Dull chrome plated steel bolt. 5 pin brass cylinder. Safety device against drawing the cylinder by rider and pillar (except cylinder 30 mm). Brass key hole plate. 3 nickel plated steel keys.

Caja de acero embutido. Cerradero de acero embutido. Pestillo de acero cromado mate. Botón de ABS cromado mate. Cilindro de latón con 5 pasadores. Protección contra el arrancamiento del cilindro mediante pilar y caballero (excepto cilindro 30 mm). Entrada de latón. 3 llaves de acero niquelado.

Finition/Finish/Acabado

Epoxy or
Gold epoxy
Epoxi dorado

Versión/Option/Versión

Double cylindre. Avec pêne 160 mm Cylindre 30 mm pour porte de garage. Sans cylindre extérieur, sans bouton. Pour cylindre profilé. Avec pêne alliage nickelé. Montage sur organigramme compatible HG5. Autres longueurs de cylindre sur demande.

Double cylinder. With 160 mm bolt and 30 mm length cylinder for garage door. Without outside cylinder. Doble cilindro. Con pestillo 160 mm cilindro 30 mm para puerta de garaje. Sin cilindro exterior.

Utilisation/Use/Utilización

Porte d'entrée
Entrance door
Puerta de entrada

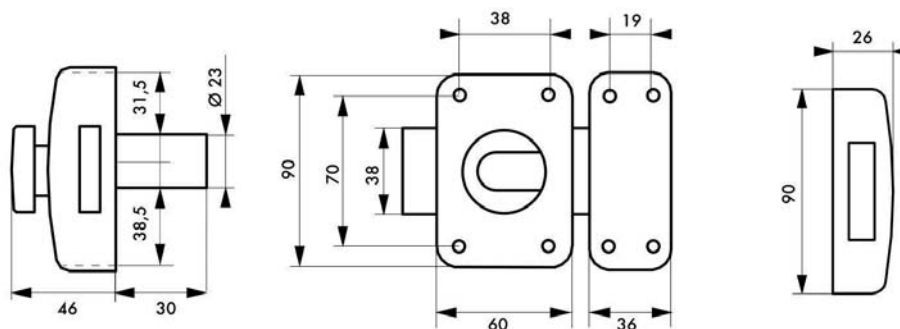

Designation	Boite	Colis.	Prix	Sachet	Colis.	Prix	Brochable					Colis.	Prix
							France	Euro 1	Euro 2	Euro 3	Euro 4		
CAPITAL à bouton et cylindre 30 mm époxy or 3 clés	00091303	1	-	-	-	-	-	-	-	-	-	-	-
CAPITAL à bouton et cylindre 40 mm époxy or 3 clés	00091310	1	-	-	-	-	-	-	-	-	-	-	-
CAPITAL à bouton et cylindre 45 mm époxy or 3 clés	00092310	1	-	-	-	-	-	-	-	-	-	-	-
CAPITAL à bouton et cylindre 50 mm	00093310	1	-	-	-	-	-	-	-	-	-	-	-
CAPITAL à bouton et cylindre 60 mm époxy or 3 clés	00091306	1	-	-	-	-	-	-	-	-	-	-	-
Boitier CAPITAL à cylindre profilé époxy or	00091307	1	-	-	-	-	-	-	-	-	-	-	-
Boitier CAPITAL à cylindre profilé époxy bronze	00003910	1	-	00903910	5	-	00303910	-	-	-	-	5	-
Boitier CAPITAL à cylindre profilé époxy blanc	00003912	1	-	-	-	-	-	-	-	-	-	-	-
CAPITAL à bouton et cylindre 70 mm époxy or 3 clés	00091370 <small>NS</small>	1	-	-	-	-	-	-	-	-	-	-	-
CAPITAL à bouton et cylindre 80 mm époxy or 3 clés	00091371 <small>NS</small>	1	-	-	-	-	-	-	-	-	-	-	-
CAPITAL à bouton et cylindre 90 mm époxy or 3 clés	00091372 <small>NS</small>	1	-	-	-	-	-	-	-	-	-	-	-
CAPITAL à bouton et cylindre 100 mm époxy or 3 clés	00091373 <small>NS</small>	1	-	-	-	-	-	-	-	-	-	-	-
CAPITAL à bouton et cylindre 110 mm époxy or 3 clés	00091374 <small>NS</small>	1	-	-	-	-	-	-	-	-	-	-	-
CAPITAL à bouton et cylindre 120 mm époxy or 3 clés	00091375 <small>NS</small>	1	-	-	-	-	-	-	-	-	-	-	-

Tarif conditionnement non décollable

CAPITAL à bouton et cylindre 40 mm époxy or 3 clés	00091315	25	-	-	-	-	-	-	-	-	-	-	-
CAPITAL à bouton et cylindre 45 mm époxy or 3 clés	00092315	25	-	-	-	-	-	-	-	-	-	-	-
CAPITAL à bouton et cylindre 50 mm époxy or 3 clés	00093315	25	-	-	-	-	-	-	-	-	-	-	-

NS Non stocké/Non-stored/Productos no estocado - Sur stock Europe Zone 1 et Zone 2, nous consulter pour délai d'approvisionnement - E Epuement/Stock depletion/Agotamiento del stock

LA CLE UNIQUE RESIST



NIVEAU DE SÉCURITÉ



GARANTIE



X 6

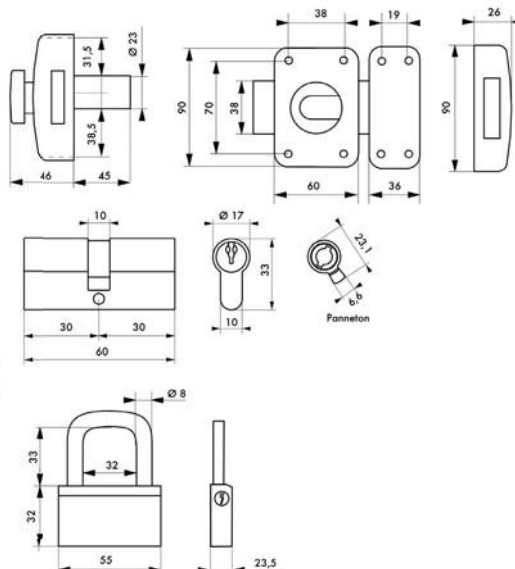

Description/Description/Descripción

Lot de 2 ou 3 produits s'ouvrant avec la même clé. Possibilité de commander des verrous, cadenas et cylindres profilés complémentaires sur le même numéro de clé. En utilisant des serrures et des verrous équipés d'un cylindre profilé interchangeable, on peut répondre à tous types de fermeture avec la même clé. 6 clés acier nickelé.

Kit of 2 or 3 items keyed alike. Possibility to order other bolts, padlocks, or profile cylinders with the same keying. Using lock fitted out with profile cylinder, may equip every kinds of closing with the same keying. 6 nickel plated steel keys.

Lote de 2 ó 3 productos que se abren con la misma llave. Posibilidad de encargar cerrojos, candados y cilindros perfilados complementarios con el mismo número de llave. Utilizando cerraduras y cerrojos equipados de un cilindro perfilado intercambiable es posible responder a todo tipo de cierres con la misma llave. 6 llaves de acero niquelado

Version/Option/Versión

Verrou / Cadenas / Cylinder

Bolt, Padlock, Cylinder

Cerrojo, Candado, Cilindro

Utilisation/Use/Utilización

Pavillon / appartement : porte d'entrée et de service, de garage, portail, porte fenêtre... Complexe sportif : tous types de bâtiments privés ou administratifs

House, flat, main door, second door, garage, gateway, door-windows. Sport center, all kinds of private or administrative buildings.

inds of private or administrative buildings. Vivienda individual / apartamento: puerta de entrada y de servicio, de garaje, portal, puerta, ventana, etc. Complejo deportivo, todo tipo de edificios privados o administrativos.

Designation	Boite	Colis.	Prix	Sachet	Colis.	Prix	Brochable					Colis.	Prix
							France	Euro 1	Euro 2	Euro 3	Euro 4		
Lot cadenas NAUTIC, cylindre profilé 30x30mm, verrou CAPITAL à bouton et cylindre HG 45 mm 6 clés	-	-	-	-	-	-	00563853	-	-	-	-	2	-
Lot cadenas NAUTIC, cylindre profilé 30x30mm, verrou CAPITAL DC et cylindre HG 45 mm 6 clés	-	-	-	-	-	-	00563852	-	-	-	-	2	-

Designation	Boite	Colis.	Prix	Sachet	Colis.	Prix	Brochable					Colis.	Prix
							France	Euro 1	Euro 2	Euro 3	Euro 4		
Verrou CAPITAL bouton 45 mm et cylindre profilé HG 30 x 30 mm 6 clés	-	-	-	-	-	-	00303610	-	-	-	-	5	-
Verrou CAPITAL DC 45 mm et cylindre profilé HG 30 x 30 mm 6 clés	-	-	-	-	-	-	00303620	-	-	-	-	5	-
Paire verrous CAPITAL bouton et cylindre à goupilles HG 45 mm 6 clés	-	-	-	-	-	-	00503110	-	-	-	-	2	-
Paire verrous CAPITAL double cylindre à goupilles HG 45 mm 6 clés	-	-	-	-	-	-	00503120	-	-	-	-	2	-
Paire verrous CAPITAL bouton 45 mm et cylindre profilé HG 30x30 mm 6 clés	-	-	-	-	-	-	00503610	-	-	-	-	2	-
Paire verrous CAPITAL Dbl. cyl. 45 mm et cylindre profilé HG 30 x 30 mm 6 clés	-	-	-	-	-	-	00503620	-	-	-	-	2	-
Coque de 2 CYLINDRES PROFILES HG s'ouvrant 30 x 30 mm 6 clés	-	-	-	-	-	-	00225330	-	-	-	-	10	-
Coque de 3 CYLINDRES PROFILES HG s'ouvrant 30 x 30 mm 6 clés	-	-	-	-	-	-	00235330	-	-	-	-	10	-



LA CLÉ UNIQUE
10 bonnes raisons d'avoir 1 seul clé !

*N'hésitez plus...
Simplifiez vous la vie !*

Verrou de haute sûreté / SURVEYOR

RESIST

Fourni avec Protecteur de cylindre + plaque de renfort pour une sécurité accrue.



NIVEAU DE SÉCURITÉ



GARANTIE



X 4

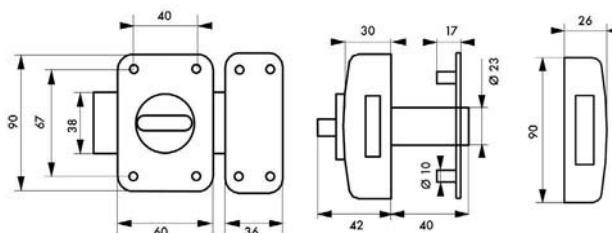

Description/Description/Descripción

Coffre en acier embouti. Gâche en acier embouti. Pêne acier chromé. Bouton à barrette ABS chromé. Cylindre laiton à pompes à 5 éléments. de verrouillage. Protecteur de cylindre en acier cémenté contre le perçage et l'arrachement. Plaque de renfort en alliage moulé. 4 clés à insert laiton avec carte personnelle.

Pressed steel case. Pressed steel striker. Chrome plated steel bolt. Chrome plated ABS knob. Tumblers brass cylinder. Hardened steel guard cylinder against drilling and tearing off. Strengthening plate. 4 keys in insert brass and patent registered keys with owner card allowing key duplication only in factory.

Caja de acero embutido. Cerradero de acero embutido. Pestillo de acero cromado. Botón de horquilla ABS cromado. Cilindro de latón de bombas. Protector de cilindro de acero cementado contra el taladrado y el arranque. Placa de refuerzo de aleación. 4 llaves con inserción de latón y tarjeta de propiedad para la reproducción de las llaves en fábrica.

Finition/Finish/Acabado

Epoxy bronze

Bronze epoxy

Epoxi bronce

Versión/Option/Versión

Double cylindre. Verrou EMERAUDE sans protecteur de cylindre, sans plaque de renfort, 3 clés avec carte personnelle. Sur numéro imposé et sur même combinaison.

Double cylinder. EMERAUDE without guard and without strengthening plate, 3 keys with owner card. Delivery under requested number and keyed alike.

Doble cilindro. Cerrojo EMERAUDE sin protector de cilindro y sin placa de refuerzo de aleación, 3 llaves con tarjeta de propiedad. Con número impuesto y con la misma combinación.

Utilisation/Use/Utilización

Porte d'entrée

Entrance door

Puerta de entrada

Designation	Boite	Colis.	Prix	Sachet	Colis.	Prix	Brochable					Colis.	Prix
							France	Euro 1	Euro 2	Euro 3	Euro 4		
EMERAUDE à bton et cyl. à pompes 40 mm époxy bronze 4 clés	00007510	1	-	00907510	10	-	00207510	-	-	-	-	2	-
SURVEYOR à bton et cyl. à pompes 40 mm époxy bronze 4 clés	00007010	1	-	-	-	-	00307010	-	-	-	-	2	-
SURVEYOR à bton et cyl. à pompes 45 mm époxy or 4 clés	00017010	1	-	-	-	-	00317010	-	-	-	-	2	-

⚠ Non stocké/Non-stored/Producto no estocado - 📦 Sur stock Europe Zone 1 et Zone 2, nous consulter pour délai d'approvisionnement - 📦 Epuisement/Stock depletion/Agotamiento del stock

Verrou de haute sûreté / ATLANTIC M RESIST



NIVEAU DE SÉCURITÉ



GARANTIE



X 4

Clés réversibles et protection contre le crochetage et le perçage.



Foncet vissé démontable

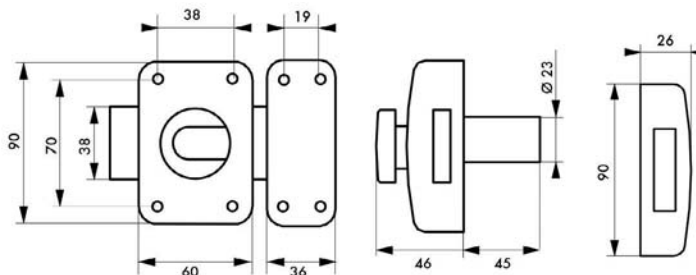

Description/Description/Descripción

Coffre en acier embouti. Gâche en acier embouti. Pêne acier chromé satin. Bouton ABS chromé satin. Cylindre laiton 9 à 19 goupilles maillechort. Goupilles anti-crochetage. Protection contre le perçage par première goupille en acier trempé. Protection contre l'arrachement du cylindre par pilier et cavalier. 4 clés plates maillechort réversibles, brevetées avec carte de propriété permettant la reproduction des clés exclusivement en usine. Pièces mobiles dans la clé interdisant toute reproduction hors usine

Pressed steel lock case. Pressed steel strike plate. Satin chrome-plated finish steel lock bolt. Satin chrome-plated finish ABS knob. Brass cylinder with 9 to 19 nickel silver pins. Anti-picking pins. Protection against drilling through a first hardened steel pin. Cylinder protected against pull out through pillar and staple. 4 patented reversible nickel silver keys with property card allowing exclusive key reproduction in the factory. Moving parts in the key that prohibit any reproduction off factory.

Caja de acero embutido. Gacheta de acero embutido.

Pestillo de acero cromado satiné. Botón ABS cromado satiné. Cilindro de latón 9 a 19 pasadores maillechort. Pasadores anti-forzado. Protección contra la perforación por primer pasador de acero templado. Protección contra el desgarramiento del cilindro por pilar y puente. 4 llaves planas maillechort reversibles patentadas con tarjeta de propiedad que permite la reproducción de las llaves exclusivamente en fábrica. Piezas móviles en la llave que prohíben cualquier reproducción fuera de fábrica

Finition/Finish/Acabado

Epoxy or
Gold epoxy
Epoxi dorado

Versión/Option/Versión

Double cylindre
Double cylinder
Doble cilindro

Utilisation/Use/Utilización

Porte d'entrée
Porte d'entrée
Puerta de entrada

Designation	Boite	Colis.	Prix	Sachet	Colis.	Prix	Brochable				Colis.	Prix	
							France	Euro 1	Euro 2	Euro 3			Euro 4
ATLANTIC M à bouton et cylindre 45mm époxy or 4 clés	00090504	1	-	-	-	-	00390504	-	-	-	-	2	-

Non stocké/Non-stored/Producto no estocado - Sur stock Europe Zone 1 et Zone 2, nous consulter pour délai d'approvisionnement - Epuement/Stock depletion/Agotamiento del stock

Verrou de haute sûreté / FEDERAL RESIST



NIVEAU DE SÉCURITÉ



GARANTIE



X 4



Foncet vissé
démontable

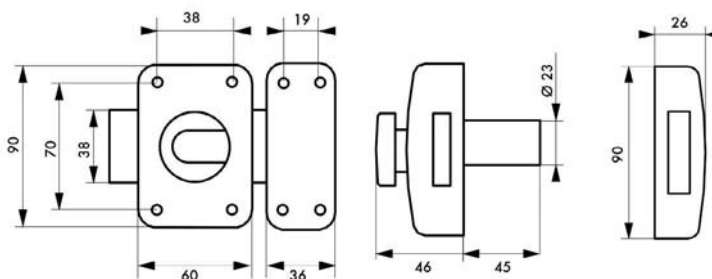

Description/Description/Descripción

Coffre en acier embouté. Gâche en acier embouté. Pêne acier chromé satin. Bouton ABS chromé satin. Cylindre laiton de 4 à 5 doubles goupilles télescopiques. Goupilles anti-crochetage. Protection contre le perçage par première goupille en acier trempé. Protection contre l'arrachement du cylindre par pilier et cavalier. 4 clés plates réversibles maillechort avec anneau ergonomique moulé, avec carte de propriété permettant la reproduction des clés exclusivement en usine. Mécanisme magnétique interdisant toute reproduction hors usine.

Pressed steel lock case. Pressed steel strike plate. Chrome-plated satin finish steel lock bolt. Chrome-plated satin finish ABS knob. Magnetic 4 to 5 double telescopic pin mechanism. Anti-picking pins. Protection against drilling through a first hardened steel pin. Cylinder protected against pull out through pillar and staple. 4 nickel-plated brass keys with ABS insert and property card allowing exclusive key reproduction in the factory.

Caja de acero embutido. Gacheta de acero embutido.

Pestillo de acero cromado satiné. Botón ABS cromado satiné. Cilindro latón de 4 a 5 dobles pasadores. Pasadores anti-forzado. Protección contra la perforación por primer pasador de acero templado. Protección contra el desgarramiento del cilindro por pilar y puente. 4 llaves de latón niquelado con inserto ABS y tarjeta de propiedad que permite la reproducción de las llaves exclusivamente en fábrica.

Finition/Finish/Acabado

Epoxy or
Gold epoxy
Epoxi dorado

Versión/Option/Versión

Double cylinder
Double cylinder
Doble cilindro

Utilisation/Use/Utilización

Porte d'entrée
Entrance door
Puerta de entrada

Designation	Boite	Colis.	Prix	Sachet	Colis.	Prix	Brochable					Colis.	Prix
							France	Euro 1	Euro 2	Euro 3	Euro 4		
FEDERAL à bouton et cylindre 45mm epoxy or 4 clés	00090507	1	-	-	-	-	00390507	-	-	-	-	2	-

⚠ Non stocké/Non-stored/Producto no estocado - 📦 Sur stock Europe Zone 1 et Zone 2, nous consulter pour délai d'approvisionnement - 📦 Epuisement/Stock depletion/Agotamiento del stock

Verrou de sûreté / PLAISANCE RESIST



NIVEAU DE SÉCURITÉ



GARANTIE



X 3



Verrou, intégralement en inox.

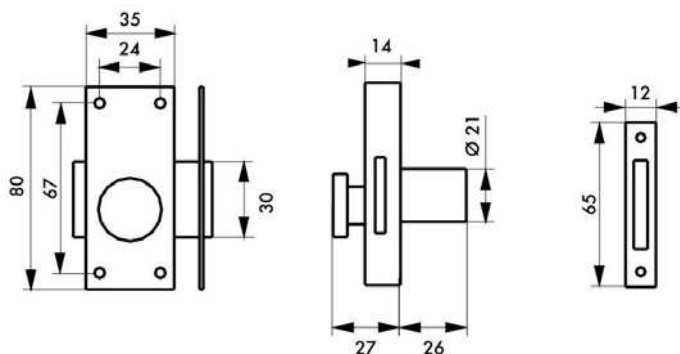

Description/Description/Descripción

Coffre plat inox cambré. Gâche plate inox cambré. Pêne laiton chromé. Bouton nylon. Mécanisme intérieur inoxydable. Cylindre laiton chromé à 5 goupilles. Entrée inox. 3 clés en laiton.

Cambered stainless steel case. Cambered stainless steel flat striker. Black nylon knob. Chrome plated brass bolt. Stainless inner mechanism. 5 pin chrome plated brass cylinder. Stainless steel key hole plate. 3 brass keys.

Caja plana de acero inoxidable curvado. Cerradero plano de acero inoxidable curvado. Pestillo de latón cromado. Botón de nailon. Mecanismo interior inoxidable. Cilindro de latón cromado con 5 pasadores. Entrada acero inoxidable. 3 llaves de latón.

Finition/Finish/Acabado

Inox
Stainless steel
Acero inoxidable

Utilisation/Use/Utilización

Plaisance
Boats
Recreo

Designation	Boite	Colis.	Prix	Sachet	Colis.	Prix	Brochable					Colis.	Prix
							France	Euro 1	Euro 2	Euro 3	Euro 4		
PLAISANCE inox à bouton et cylindre à goupilles 26 mm 3 clés	-	-	-	00901311	5	-	00201311	-	-	-	-	5	-

Non stocké/Non-stored/Producto no estocado - Sur stock Europe Zone 1 et Zone 2, nous consulter pour délai d'approvisionnement - Epuement/Stock depletion/Agotamiento del stock

Verrou de sûreté / MIRAGE

RESIST



NIVEAU DE SÉCURITÉ



GARANTIE



X 3

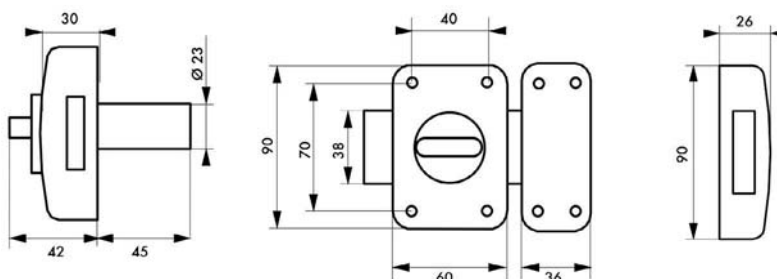

Description/Description/Descripción

Coffre laiton embouti. Gâche laiton embouti. Pêne en laiton. Bouton barette laiton. Cylindre laiton à 5 goupilles. Protection contre l'arrachement du cylindre par pilier et cavalier. Entrée laiton. 3 clés en acier nickelé.
Pressed brass case. Pressed brass striker. Brass bolt. Brass knob. 5 pin brass cylinder. Safety device against drawing the cylinder by rider and pillar. Brass key hole plate. 3 nickel plated steel keys.

Caja de latón embutido. Cerradero de latón embutido. Pestillo de latón. Botón con horquilla de latón. Cilindro de latón con 5 pasadores. Protección contra el arrancamiento del cilindro por pilar y caballete. Entrada de latón. 3 llaves de acero niquelado.

Finition/Finish/Acabado

Laiton

Brass

Latón

Versión/Option/Versión

Double cylindre

Double cylinder

Doble cilindro

Utilisation/Use/Utilización

Porte d'entrée

Entrance door

Puerta de entrada

Designation	Boite	Colis.	Prix	Sachet	Colis.	Prix	Brochable					Colis.	Prix
							France	Euro 1	Euro 2	Euro 3	Euro 4		
MIRAGE à bouton et cylindre 45 mm laiton 3 clés	00003012	1	-	-	-	-	00303012	-	-	-	-	1	-

⚠ Non stocké/Non-stored/Producto no estocado - 📦 Sur stock Europe Zone 1 et Zone 2, nous consulter pour délai d'approvisionnement - 📦 Epuisement/Stock depletion/Agotamiento del stock

Verrou de haute sûreté / INOX RESIST



NIVEAU DE SÉCURITÉ



GARANTIE



Verrou anti corrosion.

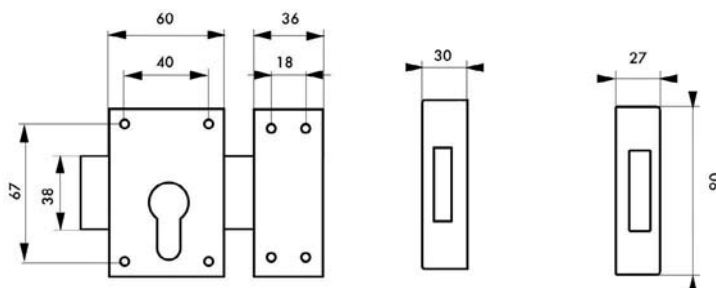

Description/Description/Descripción

Coffre et gâche inox 304 L cambré. Pêne inox.
Cambered 304 L stainless steel case and striker. Stainless steel bolt.

Caja y cerradero de acero inoxidable 304 L curvado.
Pestillo de acero inoxidable.

Finition/Finish/Acabado

Inox brossé
Polished stainless steel
Epoxi negro granitado

Utilisation/Use/Utilización

Porte d'entrée
Entrance door
Puerta de entrada

Designation	Boite	Colis.	Prix	Sachet	Colis.	Prix	Brochable					Colis.	Prix
							France	Euro 1	Euro 2	Euro 3	Euro 4		
Boitier MIRAGE à cylindre profilé inox	00003919	1	-	-	-	-	00203919	-	-	-	-	5	-

Non stocké/Non-stored/Producto no estocado - Sur stock Europe Zone 1 et Zone 2, nous consulter pour délai d'approvisionnement - Epuisement/Stock depletion/Agotamiento del stock

Verrou de haute sûreté / COBRA RESIST



NIVEAU DE SÉCURITÉ



GARANTIE



X 4



Clés type coffre-fort, protecteur et plaque de renfort pour une protection renforcée.

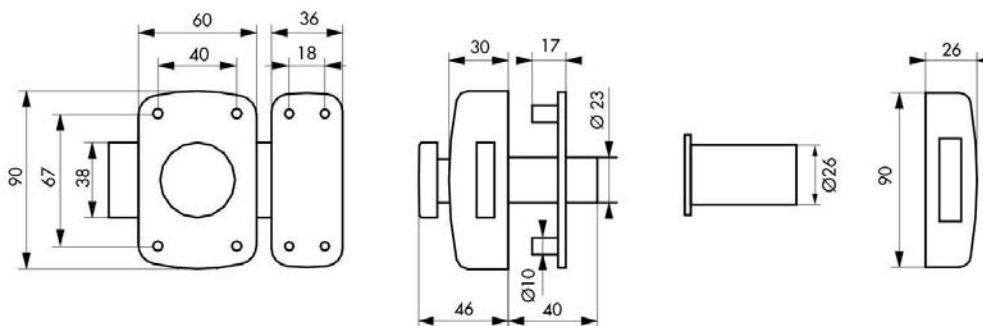

Description/Description/Descripción

Coffre en acier embouti. Gâche en acier embouti. Pêne acier chromé. Bouton ABS chromé. Cylindre laiton chromé à 5 pompes axiales et avec dispositif pompe contre-pompe radiale contre le crochetage. Protecteur de cylindre en acier cémenté contre le perçage et l'arrachement. Plaque de renfort en alliage moulé. 4 clés brevettées à reproduction interdite avec carte de propriété pour la reproduction des clés en usine.

Pressed steel case and striker. Chrome plated steel bolt. Chrome plated ABS knob. Chrome plated brass cylinder with 5 axial tumblers and radial security mechanism. Hardened steel guard cylinder against drilling and tearing off. Strengthening plate. 4 patent registered keys with owner card allowing key duplication only in factory.
Caja de acero embutido. Cerradero de acero embutido. Pestillo de acero cromado. Botón de ABS cromado. Cilindro de latón cromado con 5 bombas axiales y con dispositivo de bomba y contrabomba radial. Protector de cilindro de acero cementado contra el taladrado y el arrancamiento.

Finition/Finish/Acabado

Epoxy bronze
Bronze epoxy
Epoxi bronce

Versión/Option/Versión

Double cylinder. Sur numéro imposé et sur même combinaison.

Double cylinder. Delivery under requested number and keyed alike.

Doble cilindro. Con número impuesto y con la misma combinación.

Utilisation/Use/Utilización

Porte d'entrée
Entrance door
Puerta de entrada

Designation	Boite	Colis.	Prix	Sachet	Colis.	Prix	Brochable					Colis.	Prix
							France	Euro 1	Euro 2	Euro 3	Euro 4		
COBRA à bouton et cylindre 45 mm époxy bronze 4 clés	M1007410	1	-	-	-	-	M1307410	-	-	-	-	2	-

⚠ Non stocké/Non-stored/Producto no estocado - ☑ Sur stock Europe Zone 1 et Zone 2, nous consulter pour délai d'approvisionnement - ☒ Epuisement/Stock depletion/Agotamiento del stock

Verrou de haute sûreté / TRANSIT 2 A2P* *

RESIST



GARANTIE



X 4

Verrou de haute sûreté
breveté reconnu par les
sociétés d'assurances

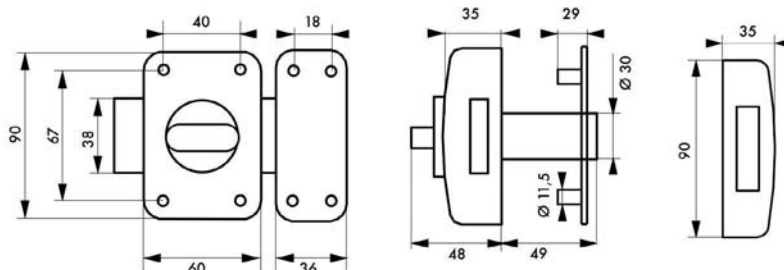

Description/Description/Descripción

Coffre et gâche en acier embouti. Pêne acier cémenté trempé nickelé. Bouton ABS chromé. Cylindre à 8 goupilles en acier trempé. Cabochon de protection du cylindre en acier zingué. Plaque de blindage du coffre en acier. Plaque de renfort extérieure en acier. 4 clés plates laiton nickelé réversibles avec carte de propriété dans un emballage scellé pour la reproduction des clés en usine.
Pressed steel case and striker. Hardened nickel plated steel bolt. Chrome plated ABS knob. 8 hardened steel pin brass cylinder. Zinc steel cylinder guard. Steel armour plate for the case. hardened steel strengthening plate. 4 nickel plated brass reversible keys with owner card in a sealed packing allowing key duplication in factory.
Caja y cerradero de acero embutido. Pestillo de acero cementado templado níquelado. Botón de ABS cromado. Cilindro con 8 pistones de acero templado. Cabujón de protección del cilindro de acero cincado. Placa de blindaje de la caja de acero. Placa de refuerzo

exterior de acero cementado. 4 llaves de latón níquelado reversibles con tarjeta de propiedad en un embalaje sellado para la reproducción de las llaves en fábrica.

Finition/Finish/Acabado

Epoxy bronze
Bronze epoxy
Epoxi bronce

Versión/Option/Versión

Double cylindre. Sur numéro imposé et sur même combinaison.

Double cylinder. Delivery under requested number and keyed alike.

Doble cilindro. Con número impuesto y con la misma combinación.

Utilisation/Use/Utilización

Porte d'entrée
Entrance door
Puerta de entrada

Designation	Boite	Colis.	Prix	Sachet	Colis.	Prix	Brochable					Colis.	Prix
							France	Euro 1	Euro 2	Euro 3	Euro 4		
TRANSIT 2 A2P* à bouton et cylindre 45 mm époxy bronze 4 clés	00098610	1	-	-	-	-	00398610	-	-	-	-	2	-

Non stocké/Non-stored/Producto no estocado - Sur stock Europe Zone 1 et Zone 2, nous consulter pour délai d'approvisionnement - Epuement/Stock depletion/Agotamiento del stock

Verrou de haute sûreté / ADRIATIC A2P* *

RESIST



GARANTIE



X 4

Verrou de haute sûreté
breveté reconnu par les
sociétés d'assurances

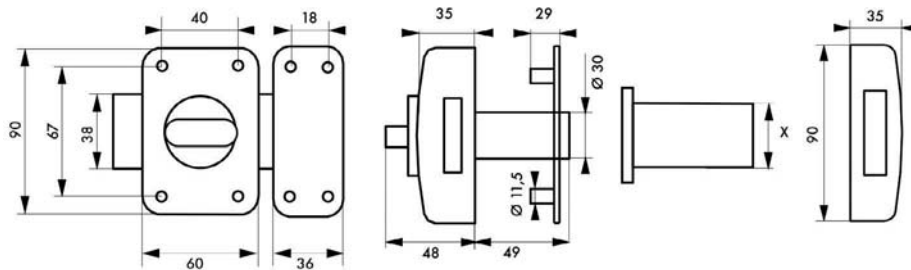

Description/Description/Descripción

Coffre en acier embouti. Gâche en acier embouti. Pêne acier chromé. Bouton ABS chromé. Cylindre laiton de 6 à 22 goupilles sur 5 rangées. Goupilles en acier trempé anti-crochetage. Cabochon de protection du cylindre en acier zingué. Plaque de blindage du coffre en acier. Plaque de renfort extérieure en acier. 4 clés laiton nickelé avec insert ABS, avec carte de propriété permettant la reproduction des clés exclusivement en usine. Pièce mobile anti-crochetage interne au cylindre interdisant toute reproduction hors usine
Pressed steel lock case. Pressed steel strike plate. Chrome-plated steel lock bolt. Chrome-plated ABS knob. Brass cylinder with 6 to 22 pins on 5 rows. Anti-picking hardened steel pins. dipped zinc-plated steel protective cabochon for cylinder. Lock case steel armor plate. Exterior steel reinforcing plate. 4 nickel-plated brass keys with ABS insert and property card allowing exclusive key reproduction in the factory.
 Caja de acero embutido. Gacheta de acero embutido.

Pestillo de acero cromado. Botón ABS cromado. Cilindro de latón de 6 a 22 pasadores sobre 5 hileras. Pasadores de acero templado anti-forzado. Capuchón de protección del cilindro. de acero cincado. Placa de blindaje de la caja de acero Placa de refuerzo exterior de acero. 4 llaves de latón niquelado con inserto ABS y tarjeta de propiedad que permite la reproducción de las llaves exclusivamente en fábrica.

Finition/Finish/Acabado

Epoxy bronze
 Bronze epoxy
 Epoxi bronze

Versión/Option/Versión

Double cylindre
 Double cylinder
 Doble cilindro

Utilisation/Use/Utilización

Porte d'entrée
 Entrance door
 Puerta de entrada

Designation	Boite	Colis.	Prix	Sachet	Colis.	Prix	Brochable					Colis.	Prix
							France	Euro 1	Euro 2	Euro 3	Euro 4		
ADRIATIC A2P* à bouton et cylindre 45 mm époxy bronze 4 clés	00090530	1	-	-	-	-	00390530	-	-	-	-	2	-

⚠ Non stocké/Non-stored/Producto no estocado - 📦 Sur stock Europe Zone 1 et Zone 2, nous consulter pour délai d'approvisionnement - 📦 Epuisement/Stock depletion/Agotamiento del stock

Verrou de sûreté / ETENDARD

ECO



NIVEAU DE SÉCURITÉ



GARANTIE



X 3

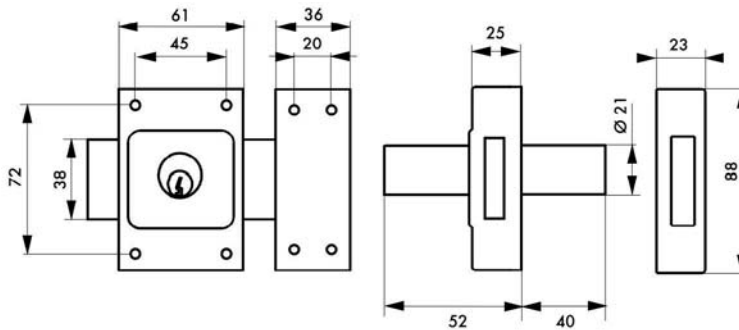

Description/Description/Descripción

Coffre acier cambré. Gâche acier cambré. Pêne acier chromé. Cylindre laiton à 4 goupilles. Entrée acier zingué. 3 clés en acier nickelé.

Cambered steel case. Cambered steel striker. Chrome plated steel bolt. 4 pin brass cylinder. Zinc steel key hole plate. 3 nickel plated steel keys.

Caja de acero curvado. Cerradero de acero curvado. Pestillo de acero cromado. Cilindro de latón con 4 pasadores. Entrada de acero cincado.. 3 llaves de acero niquelado.

Finition/Finish/Acabado

Epoxy bronze

Bronze epoxy

Epoxi bronze

Version/Option/Versión

A bouton. Sans bouton.

With knob. Without knob

Con botón. Sin botón

Utilisation/Use/Utilización

Porte d'entrée vitrée

Glass entrance door

Puerta de entrada acristalada

Designation	Boite	Colis.	Prix	Sachet	Colis.	Prix	Brochable					Colis.	Prix
							France	Euro 1	Euro 2	Euro 3	Euro 4		
ETENDARD à double cylindre Ø 21 x 40 mm 3 clés	00001029	1	-	00901029	5	-	00301029	-	-	-	-	5	-

Tarif conditionnement non décollable

ETENDARD à double cyl. Ø 21 x 40 mm 3 clés en boîte 001029	00051022	30	-	-	-	-	-	-	-	-	-	-	-
--	----------	----	---	---	---	---	---	---	---	---	---	---	---

Non stocké/Non-stored/Producto no estocado - Sur stock Europe Zone 1 et Zone 2, nous consulter pour délai d'approvisionnement - Epuement/Stock depletion/Agotamiento del stock

Verrou de sûreté / CONCORDE

ECO



NIVEAU DE SÉCURITÉ



GARANTIE



X 3

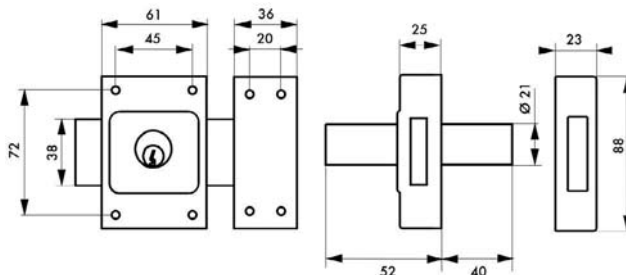

Description/Description/Descripción

Coffre acier cambré. Gâche acier cambré. Pêne acier nickelé. Cylindre laiton à 5 goupilles. Entrée laiton. 3 clés en acier nickelé.

Cambered steel case. Cambered steel striker. Nickel plated steel bolt. 5 pin brass cylinder. Brass key hole plate. 3 nickel plated steel keys.

Caja de acero curvado. Cerradero de acero curvado. Pestillo de acero niquelado. Cilindro de latón con 5 pasadores. Entrada de latón. 3 llaves de acero niquelado.

Finition/Finish/Acabado

Epoxy bronze

Bronze epoxy

Epoxi bronce

Version/Option/Versión

A bouton. Sans cylindre à bouton. Boitier avec pêne alliage nickelé pour cylindre profilé.

With knob. Without cylinder with knob. For profile cylinder.

Con botón. Sin cilindro de botón. Caja para cilindro perfilado.

Utilisation/Use/Utilización

Porte d'entrée vitrée

Glass entrance door

Puerta de entrada acristalada

Designation	Boite	Colis.	Prix	Sachet	Colis.	Prix	Brochable					Colis.	Prix
							France	Euro 1	Euro 2	Euro 3	Euro 4		
CONCORDE à double cyl. Ø 21 x 40 mm époxy bronze 3 clés	00001020	1	-	-	-	-	00301020	-	-	-	-	5	-
CONCORDE à double cyl. Ø 21 x 45 mm époxy bronze 3 clés	-	-	-	00911020 NS E	5	-	00311020	-	-	-	-	5	-

NS Non stocké/Non-stored/Producto no estocado - ☑ Sur stock Europe Zone 1 et Zone 2, nous consulter pour délai d'approvisionnement - E Epuisement/Stock depletion/Agotamiento del stock

Verrou de sûreté / CORVETTE

PROTECT



NIVEAU DE SÉCURITÉ



GARANTIE



X 3

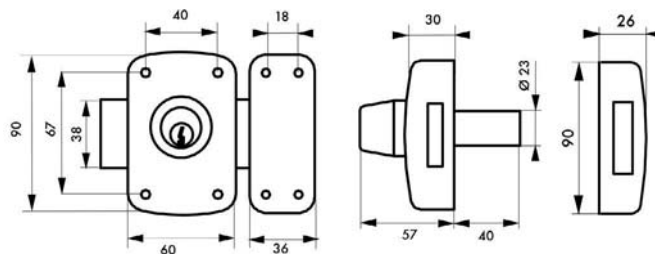

Description/Description/Descripción

Coffre acier embouti. Gâche acier embouti. Pêne en acier chromé. Cylindre double laiton à 5 goupilles. Entrée laiton. 3 clés en acier nickelé.

Pressed steel case. Pressed steel striker. Chrome plated steel bolt. Chrome plated ABS knob. 5 pin brass cylinder. Brass key hole plate. 3 nickel plated steel keys.

Caja de acero embutido. Cerradero de acero embutido. Pestillo de acero cromado. Botón con horquilla de ABS cromado. Cilindro de latón con 5 pasadores. Entrada de latón. 3 llaves de acero niquelado.

Finition/Finish/Acabado

Epoxy bronze. Chromé

Bronze epoxy. Chrome plated

Epoxi bronce. Cromado

Version/Option/Versión

A bouton. Avec pêne 160 mm cylindre 30 mm. pour porte de garage. Sans cylindre extérieur.

With knob. With 160 mm bolt and 30 mm length cylinder for garage door. Without outside cylinder.

Con botón. Con pestillo 160 mm cilindro 30 mm para puerta de garaje. Sin cilindro exterior.

Utilisation/Use/Utilización

Porte d'entrée vitrée

Glass entrance door

Puerta de entrada acristalada

Designation	Boite	Colis.	Prix	Sachet	Colis.	Prix	Brochable					Colis.	Prix
							France	Euro 1	Euro 2	Euro 3	Euro 4		
CORVETTE à double cyl. Ø 23 x 40 mm epoxy bronze 3 clés	00003020	1	-	-	-	-	00303020	-	-	-	-	5	-
CORVETTE à double cyl. Ø 23 x 45 mm epoxy bronze 3 clés	00013020	1	-	00913020	5	-	00313020	-	-	-	-	5	-
CORVETTE à double cyl. Ø 23 x 50 mm epoxy bronze 3 clés	00023020	1	-	-	-	-	00323020	-	-	-	-	5	-
CORVETTE à double cyl. Ø 23 x 60 mm epoxy bronze 3 clés	00043020	1	-	-	-	-	00343020	-	-	-	-	5	-
CORVETTE à double cyl. Ø 23 x 45 mm chromé 3 clés	00003021	1	-	-	-	-	00303021	-	-	-	-	5	-

Non stocké/Non-stored/Producto no estocado - Sur stock Europe Zone 1 et Zone 2, nous consulter pour délai d'approvisionnement - Epuisement/Stock depletion/Agotamiento del stock

Verrou de sûreté / DESIGN

PROTECT



NIVEAU DE SÉCURITÉ



GARANTIE



X 3

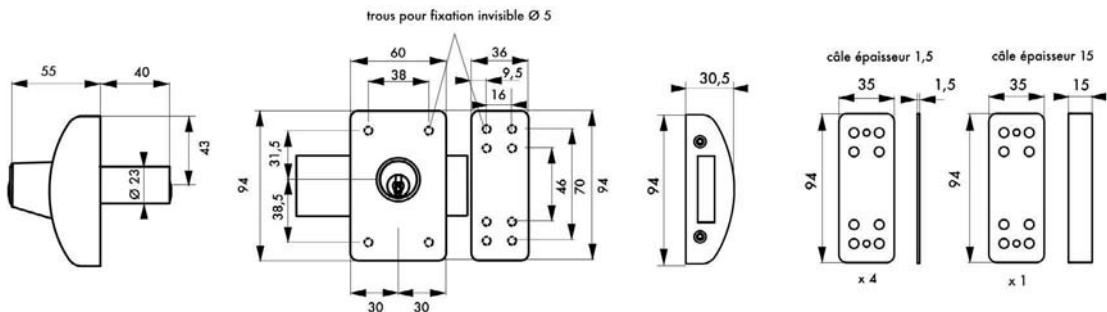

Description/Description/Descripción

Capot de coffre acier embouti. Capot de gâche acier embouti. Support de gâche et de coffre acier zingué. Pêne acier chromé. Cylindre laiton à 5 goupilles. Protection contre l'arrachement du cylindre par pilier et cavalier. 3 clés en acier nickelé. Fourni avec 5 câles de gâche pour porte à recouvrement.

Pressed steel lock case. Pressed steel strike plate. Zinc plated arched steel lock case and strike plate amount. Chrome plated finish steel lock bolt. Cylinder protected against pull out through pillar and staple. 3 nickel plated steel keys. Wedge for covering door frame.

Caja de acero embutido. Cerradero de acero embutido.

Soporte de caja y gacheta de acero arqueada cincada. Pestillo de acero cromado. Cilindro de latón de 5 pasadores. Protección contra el desgarramiento del cilindro por pilar y puente. 3 llaves de acero niquelado. Calce para puerta que recubre el marco.

Finition/Finish/Acabado

Epoxy bronze, argent
Bronze, silver epoxy
Epoxi bronce, plata

Utilisation/Use/Utilización

Porte d'entrée vitrée
Glass entrance door
Puerta de entrada acristalada

Designation	Boite	Colis.	Prix	Sachet	Colis.	Prix	Brochable				Colis.	Prix	
							France	Euro 1	Euro 2	Euro 3			Euro 4
DESIGN 5 goup. à double cyl. Ø 23 x 40 mm bronze 3 clés	00072505	1	-	-	-	-	00372505	-	-	-	-	5	-
DESIGN 5 goup. à double cyl. Ø 23 x 40 mm argent 3 clés	00072506	1	-	-	-	-	00372506	-	-	-	-	5	-
DESIGN 5 goup. à double cyl. Ø 23 x 45 mm bronze 3 clés	00072515	1	-	-	-	-	00372515	-	-	-	-	5	-
DESIGN 5 goup. à double cyl. Ø 23 x 45 mm argent 3 clés	00072516	1	-	-	-	-	00372516	-	-	-	-	5	-
DESIGN 5 goup. à double cyl. Ø 23 x 50 mm bronze 3 clés	00072525	1	-	-	-	-	00372525	-	-	-	-	5	-
DESIGN 5 goup. à double cyl. Ø 23 x 50 mm argent 3 clés	00072526	1	-	-	-	-	00372526	-	-	-	-	5	-

⚠ Non stocké/Non-stored/Producto no estocado - 📦 Sur stock Europe Zone 1 et Zone 2, nous consulter pour délai d'approvisionnement - 📦 Epuisement/Stock depletion/Agotamiento del stock

Verrou de sûreté / UNIVERSEL

PROTECT



NIVEAU DE SÉCURITÉ



MODÈLE DÉPOSÉ PROTÉGÉ



GARANTIE



X 3

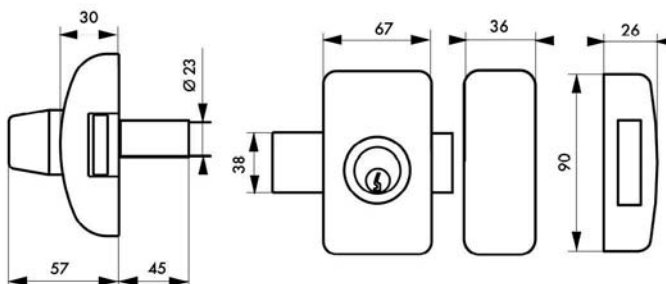
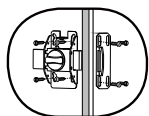

Description/Description/Descripción

Supports de coffre et gâche en acier cambré zingué. Capots de coffre et gâche en alliage. Pêne acier chromé satin. Cylindre laiton 5 goupilles. Protection contre l'arrachement. du cylindre par pilier et cavalier. Entrée laiton. 3 clés laiton nickelé. Possibilité : Clés même variure (sur demande).

dipped zinc-plated arched steel lock case and strike plate mount. Alloy lock case and strike plate cover. Chrome-plated satin finish steel lock bolt. 5 pin brass cylinder. Cylinder protected against pull out through pillar and staple. Brass backset. 3 nickel-plated brass keys.

Soporte de caja y gacheta de acero arqueada cincada.

Capó de caja y gacheta de aleación. Pestillo de acero cromado satiné. Cilindro de latón de 5 pasadores. Protección contra el desgarramiento del cilindro por pilar y puente. Entrada de latón. 3 llaves de latón niquelado.

Finition/Finish/Acabado

Epoxy bronze, argent, noir, blanc
Bronze, silver, black, and white epoxy
Epoxi bronce, plata, negro, blanco

Utilisation/Use/Utilización

Porte d'entrée vitrée
Glass entrance door
Puerta de entrada acristalada

Designation	Boite	Colis.	Prix	Sachet	Colis.	Prix	Brochable					Colis.	Prix
							France	Euro 1	Euro 2	Euro 3	Euro 4		
UNIVERSEL 5 goup. à double cyl. Ø 23 x 45 mm bronze 3 clés	00092544	1	-	-	-	-	00392544	-	-	-	-	2	-
UNIVERSEL 5 goup. à double cyl. Ø 23 x 45 mm argent 3 clés	00092546	1	-	-	-	-	00392546	-	-	-	-	2	-
UNIVERSEL 5 goup. à double cyl. Ø 23 x 45 mm blanc 3 clés	00092547	1	-	-	-	-	00392547	-	-	-	-	2	-
UNIVERSEL 5 goup. à double cyl. Ø 23 x 45 mm noir 3 clés	00092548	1	-	-	-	-	00392548	-	-	-	-	2	-

Non stocké/Non-stored/Producto no estocado - Sur stock Europe Zone 1 et Zone 2, nous consulter pour délai d'approvisionnement - Epuement/Stock depletion/Agotamiento del stock

Verrou de sûreté / UNIVERSEL A LANGUETTE PROTECT



NIVEAU DE SÉCURITÉ



GARANTIE



X 3

Cylindre ajustable à languette
de 35 à 80mm



Remplace
les verrous
existants,
sans
nouveau
perçage



Un tournevis
suffit !

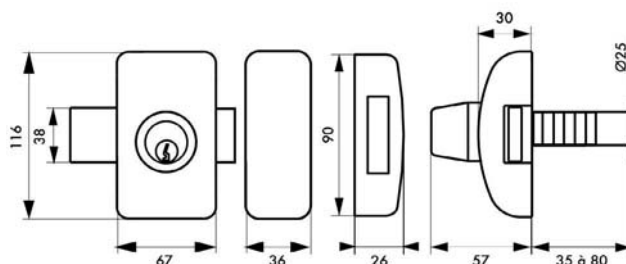

Description/Description/Descripción

Supports de coffre et gâche en acier cambré zingué.
Capots de coffre et gâche en alliage. Pêne acier chromé satin.
Cylindre laiton à languette 5 goupilles. Entrée laiton.
3 clés laiton nickelé. Possibilité : Clés même variure (sur demande).

*Zinc plated arched steel lock case and strike plate mount.
Alloy lock case and strike plate cover. Chrome-plated satin finish steel lock bolt. 5 pin brass cylinder. Brass backset. 3 nickel-plated brass keys.*

Soporte de caja y gacheta de acero arqueado cincado.
Capó de caja y gacheta de aleación. Pestillo de acero cromado satiné. Cilindro de latón de 5 pasadores. Entrada de latón. 3 llaves de latón niquelado.

Finition/Finish/Acabado

Epoxy bronze, argent, noir, blanc
Bronze, silver, black, and white epoxy

Epoxi bronze, plata, negro, blanco

Utilisation/Use/Utilización

Porte d'entrée vitrée / *Glass entrance door*

Puerta de entrada acristalada

Designation	Boite	Colis.	Prix	Sachet	Colis.	Prix	Brochable					Colis.	Prix
							France	Euro 1	Euro 2	Euro 3	Euro 4		
UNIVERSEL HG5 à double cyl. Ø 25 mm à languette bronze 3 clés	00080474	1	-	-	-	-	00380474	-	-	-	-	2	-
UNIVERSEL HG5 à double cyl. Ø 25 mm à languette argent 3 clés	00080475	1	-	-	-	-	00380475	-	-	-	-	2	-
UNIVERSEL HG5 à double cyl. Ø 25 mm à languette blanc 3 clés	00080476	1	-	-	-	-	00380476	-	-	-	-	2	-
UNIVERSEL HG5 à double cyl. Ø 25 mm à languette noir 3 clés	00080477	1	-	-	-	-	00380477	-	-	-	-	2	-

⚠ Non stocké/Non-stored/Producto no estocado - ☑ Sur stock Europe Zone 1 et Zone 2, nous consulter pour délai d'approvisionnement - ☑ Epuisement/Stock depletion/Agotamiento del stock

Verrou de sûreté / UNIVERSEL A LANGUETTE

PROTECT



NIVEAU DE SÉCURITÉ



GARANTIE



X 5

Cylindre ajustable à languette de 35 à 80mm



Remplace les verrous existants, sans nouveau perçage



Un tournevis suffit !

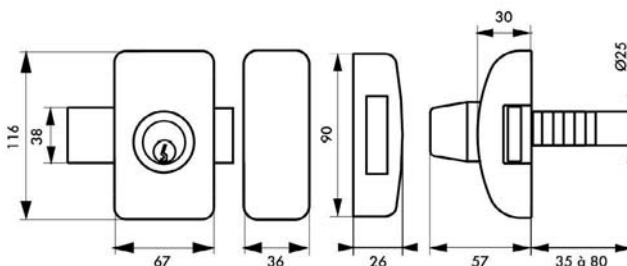

Description/Description/Descripción

Supports de coffre et gâche en acier cambré zingué. Capots de coffre et gâche en alliage. Pêne acier chromé satin. Cylindre laiton à languette de 5 goupilles. Protection contre le perçage par première goupille en acier trempé. Billes anti-crochetage interne au cylindre interdisant toute reproduction hors usine. Entrée laiton. 5 clés laiton nickelé. Possibilité : Clés même variure (sur demande).

Zinc plated arched steel lock case and strike plate mount. Alloy lock case and strike plate cover. Chrome-plated satin finish steel lock bolt. 5 pins brass cylinder. Protection against drilling through a first hardened steel pin. Balls anti-picking internal cylinder prohibiting any reproduction. Brass backset. 5 nickel-plated brass keys with personal security card.

Soporte de caja y gacheta de acero arqueado cincado. Capó de caja y gacheta de aleación. Pestillo de acero cromado satin. Cilindro de latón de 5 pistones. Protección contra la perforación por primer pasador de acero templado. Bolas anti-forzado internas al cilindro que prohíben cualquier reproducción fuera de fabrica. Entrada de latón. 5 llaves de latón niquelado patentadas con título de propiedad.

Finition/Finish/Acabado

Epoxy bronze, argent, noir, blanc
Bronze, silver, black, and white epoxy
Epoxi bronze, plata, negro, blanco

Utilisation/Use/Utilización

Porte d'entrée vitrée / Glass entrance door
Puerta de entrada acristalada

Designation	Boite	Colis.	Prix	Sachet	Colis.	Prix	Brochable					Colis.	Prix
							France	Euro 1	Euro 2	Euro 3	Euro 4		
UNIVERSEL HG5+ à double cyl. Ø 25 mm à languette bronze 3 clés	00080484	1	-	-	-	-	00380484	-	-	-	-	2	-
UNIVERSEL HG5+ à double cyl. Ø 25 mm à languette argent 3 clés	00080485	1	-	-	-	-	00380485	-	-	-	-	2	-
UNIVERSEL HG5+ à double cyl. Ø 25 mm à languette blanc 3 clés	00080486	1	-	-	-	-	00380486	-	-	-	-	2	-
UNIVERSEL HG5+ à double cyl. Ø 25 mm à languette noir 3 clés	00080487	1	-	-	-	-	00380487	-	-	-	-	2	-

Non stocké/Non-stored/Producto no estocado - Sur stock Europe Zone 1 et Zone 2, nous consulter pour délai d'approvisionnement - Epuement/Stock depletion/Agotamiento del stock

Verrou multipoints / MIRAGE 6

PROTECT



NIVEAU DE SÉCURITÉ



GARANTIE



X 3

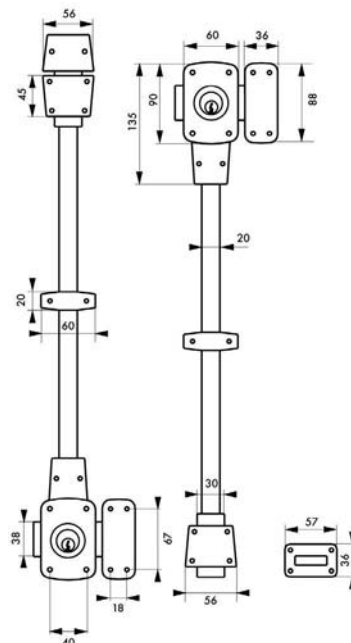

Description/Description/Descripción

Coffre acier embouté. Gâche acier embouté. Pênes acier chromé. Double cylindre laiton à 5 goupilles. 45 mm. Tringles en acier. 2 points 1x460 mm. 4 points 2x460 mm. 1 Plaque de renfort par verrou. 3 clés en acier nickelé.

Pressed steel case and striker. Chrome plated steel bolts. 5 pin brass double cylinder 45 mm length. Aluminium rods. Strengthening plate. 3 nickel plated steel keys. Finish Bronze epoxy.

Caja de acero embutido. Cerradero de acero embutido. Pestillos de acero cromado. Doble cilindro de latón con 5 pasadores de 45 mm. Trancas de aluminio. Placa de refuerzo. 3 llaves de acero niquelado.

Finition/Finish/Acabado

Epoxy bronze / *Bronze epoxy* / Epoxi bronce

Version/Option/Versión

A bouton. Droite. Gauche. Haut et côté. Bas et côté.

With knob. Right hand. Left hand. Top and side bolting.

Down and side bolting. Pair of bolts top and side / down and side bolting.

Con botón. Derecha. Izquierda. Alto y lado. Bajo y lado.

Par de cerrojos alto y lado / bajo y lado.

Utilisation/Use/Utilización

Porte d'entrée vitrée

Glass entrance door

Puerta de entrada acristalada

Designation	Boite	Colis.	Prix	Sachet	Colis.	Prix	Brochable					Colis.	Prix
							France	Euro 1	Euro 2	Euro 3	Euro 4		
Paire de verrous MIRAGE 6 double cylindre 45 mm 4 points droite	00010120	1	-	-	-	-	-	-	-	-	-	-	-
Paire de verrous MIRAGE 6 double cylindre 45 mm 4 points gauche	00010220	1	-	-	-	-	-	-	-	-	-	-	-
MIRAGE 6 • 2 points à double cylindre 45 mm haut et côté droite	00021120	1	-	-	-	-	-	-	-	-	-	-	-
MIRAGE 6 • 2 points à double cylindre 45 mm haut et côté gauche	00021220	1	-	-	-	-	-	-	-	-	-	-	-
MIRAGE 6 • 2 points à double cylindre 45 mm bas et côté droite	00022120	1	-	-	-	-	-	-	-	-	-	-	-
MIRAGE 6 • 2 points à double cylindre 45 mm bas et côté gauche	00022220	1	-	-	-	-	-	-	-	-	-	-	-

Ⓝ Non stocké/Non-stored/Producto no estocado - Ⓜ Sur stock Europe Zone 1 et Zone 2, nous consulter pour délai d'approvisionnement - Ⓞ Epuisement/Stock depletion/Agotamiento del stock

Verrou multipoints / MIRAGE 6

PROTECT



NIVEAU DE SÉCURITÉ



GARANTIE



X 3

Description/Description/Descripción

Coffre acier embouti. Gâche acier embouti. Pênes acier zingué. Cylindre laiton à 5 goupilles 45 mm. Tringles en acier 1x500 + 1x1500 mm. Plaque de renfort. Coulisseau de passage pour serrure horizontale. 3 clés en acier nickelé.

Pressed steel case and striker. Zinc plated steel bolts. Chrome plated ABS knob. 5 pin brass double cylinder 45 mm length. Aluminium rods. Strengthening plate. Mechanism to be used for horizontal lock. 3 nickel plated steel keys.

Caja de acero embutido. Cerradero de acero embutido. Pestillos de acero cromado. Doble cilindro de latón con 5 pasadores de 45 mm. Trancas de aluminio. Placa de refuerzo. 3 llaves de acero niquelado.

Finition/Finish/Acabado

Epoxy bronze

Bronze epoxy

Epoxi bronce

Version/Option/Versión

Epoxi bronce

With knob. Right hand. Left hand.

Con botón. Derecha. Izquierda.

Utilisation/Use/Utilización

Porte d'entrée vitrée

Glass entrance door

Puerta de entrada acristalada

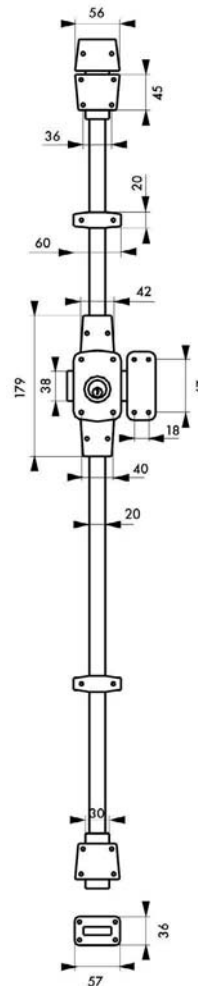

Verrou multipoints complément idéal pour une serrure à encastrer ou applique 1 point.

Designation	Boite	Colis.	Prix	Sachet	Colis.	Prix	Brochable					Colis.	Prix
							France	Euro 1	Euro 2	Euro 3	Euro 4		
MIRAGE 6 double cylindre haut et bas droite	00030120	1	-	-	-	-	-	-	-	-	-	-	-
MIRAGE 6 double cylindre haut et bas gche	00030220	1	-	-	-	-	-	-	-	-	-	-	-
Point supplémentaire pour verrou droit	00030001 <small>NS</small>	1	-	-	-	-	-	-	-	-	-	-	-
Point supplémentaire pour verrou gauche	00030011 <small>NS</small>	1	-	-	-	-	-	-	-	-	-	-	-
Tringle de 0,50	00030002	1	-	-	-	-	-	-	-	-	-	-	-
Tringle de 1 m	00030003	1	-	-	-	-	-	-	-	-	-	-	-
Tringle de 1,50 m	00030004	1	-	-	-	-	-	-	-	-	-	-	-

NS Non stocké/Non-stored/Producto no estocado - ■ Sur stock Europe Zone 1 et Zone 2, nous consulter pour délai d'approvisionnement - ■ Epuiselement/Stock depletion/Agotamiento del stock

Verrou de haute sûreté / TRAFIC 6

PROTECT



NIVEAU DE SÉCURITÉ



MODÈLE DÉPOSÉ PROTÉGÉ



GARANTIE



X 4



Foncet vissé démontable

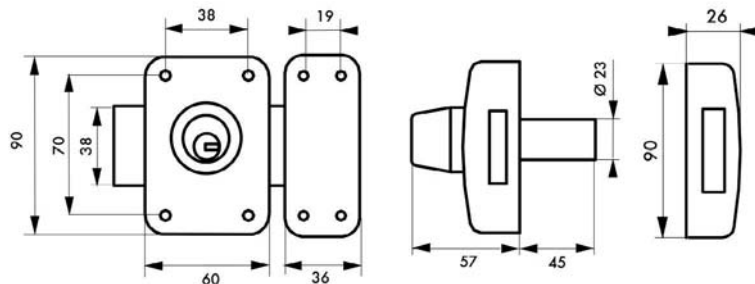

Description/Description/Descripción

Coffre en acier embouti. Gâche en acier embouti. Pêne acier chromé. Cylindre laiton à 6 goupilles. Protection contre le perçage par première goupille en acier trempé. Goupilles anti-crochetage. Protection contre l'arrachement du cylindre par pilier et cavalier. 4 clés plates réversibles laiton nickelé avec carte de propriété.

Pressed steel lock case. Pressed steel strike plate. Chrome-plated steel lock bolt. 6-pin brass cylinder. Protection against drilling by hardened steel pin. Anti-picking pins. Cylinder protected against pull out through pillar and staple. 4 nickel-plated brass reversible cylinder keys with personal card.

Caja de acero embutido. Gacheta de acero embutido. Pestillo de acero cromado. Cilindro de latón de 6 pasadores. Protección contra el taladrado por el primer

pasador de acero templado. Pasadores anti-forzado. Protección contra el desgarramiento del cilindro por pilar y puente. 4 llaves planas reversibles de latón, niquelado con tarjeta persona

Finition/Finish/Acabado

Epoxy or Gold epoxy
Epoxi dorado

Version/Option/Versión

A bouton
With knob
Con botón.

Utilisation/Use/Utilización

Porte d'entrée vitrée
Glass entrance door
Puerta de entrada acristalada

Designation	Boite	Colis.	Prix	Sachet	Colis.	Prix	Brochable					Colis.	Prix
							France	Euro 1	Euro 2	Euro 3	Euro 4		
TRAFIC 6 à double cylindre Ø 23 x 45 mm epoxy or 4 clés réversibles	00092502	1	-	00992502	10	-	00292502	-	-	-	-	2	-

⚠ Non stocké/Non-stored/Producto no estocado - 📦 Sur stock Europe Zone 1 et Zone 2, nous consulter pour délai d'approvisionnement - 📦 Epuisement/Stock depletion/Agotamiento del stock

Verrou de haute sûreté / ADRIATIC 2

PROTECT



NIVEAU DE SÉCURITÉ



MODÈLE DÉPOSÉ PROTÉGÉ



10 ans

GARANTIE



Piston mobile de sécurité



X 4



Clés brevetées et protection anti crochetage et anti perçage.



Foncet vissé démontable

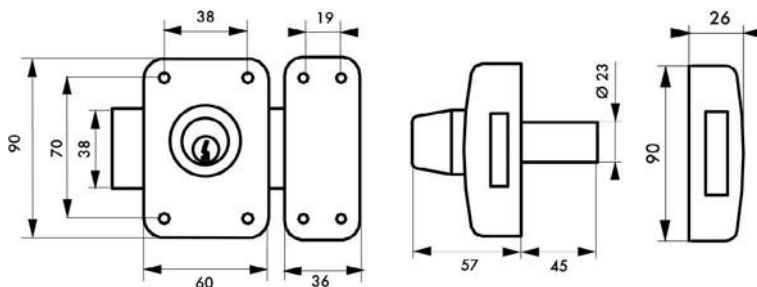

Description/Description/Descripción

Coffre en acier embouti. Gâche en acier embouti. Pêne acier chromé satin. Bouton ABS chromé satin. Cylindre laiton de 6 à 22 goupilles maillechort sur 5 rangées. Goupilles anti-crochetage. Protection contre le perçage par première goupille en acier trempé. Protection contre l'arrachement du cylindre par pilier et cavalier. 4 clés laiton nickelé avec insert ABS, avec carte de propriété permettant la reproduction des clés exclusivement en usine. Pièce mobile anti-crochetage interne. au cylindre interdisant toute reproduction hors usine.

Pressed steel lock case. Pressed steel strike plate. Satin chrome-plated finish steel lock bolt. Satin chrome-plated finish ABS knob. Brass cylinder with 6 to 22 nickel silver pins on 5 rows. Anti-picking pins. Protection against drilling through a first hardened steel pin. Cylinder protected against pull out through pillar and staple. 4 nickel-plated brass keys with ABS insert and property card allowing exclusive key reproduction in the factory. - Anti-picking moving part inside cylinder that prohibit any reproduction off factory.

Caja de acero embutido. Gacheta de acero embutido. Pestillo de acero cromado satin. Botón ABS cromado satin. Cilindro de latón de 6 a 22 pasadores maillechort sobre 5 hileras. Pasadores anti-forzado. Protección contra la perforación por primer pasador de acero templado. Protección contra el desgarramiento del cilindro por pilar y puente. 4 llaves de latón niquelado con inserto ABS y tarjeta de propiedad que permite la reproducción de las llaves exclusivamente en fábrica.

Finition/Finish/Acabado

Epoxy or gold epoxy
Epoxi dorado

Version/Option/Versión

A bouton
With knob
Con botón

Utilisation/Use/Utilización

Porte d'entrée vitrée
Glass entrance door
Puerta de entrada acristalada

Designation	Boîte	Colis.	Prix	Sachet	Colis.	Prix	Brochable					Colis.	Prix
							France	Euro 1	Euro 2	Euro 3	Euro 4		
ADRIATIC 2 à double cylindre Ø 23 x 45 mm epoxy or 4 clés	00092503	1	-	-	-	-	00392503	-	-	-	-	2	-

Non stocké/Non-stored/Producto no estocado - Sur stock Europe Zone 1 et Zone 2, nous consulter pour délai d'approvisionnement - Epuement/Stock depletion/Agotamiento del stock

Verrou de haute sûreté / UNIVERSEL

PROTECT



NIVEAU DE SÉCURITÉ



GARANTIE



X 4

Pose facile et rapide dans les trous existants à l'aide d'un seul tournevis

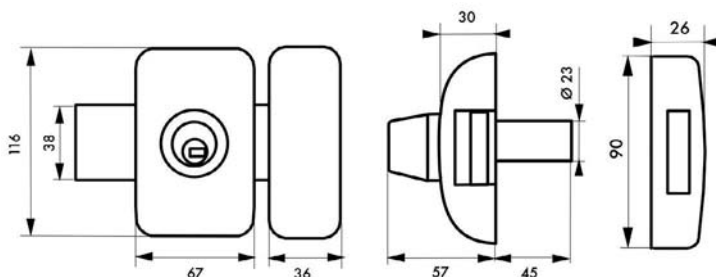
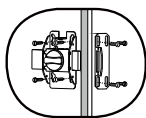

Description/Description/Descripción

Supports de coffre et gâche en acier cambré zingué. Capots de coffre et gâche en alliage. Pêne acier chromé satin. Cylindre laiton 6 goupilles. Goupilles anti-crochetage. Protection contre le perçage par première goupille en acier trempé. Protection contre l'arrachement du cylindre par pilier et cavalier. Entrée laiton. 4 clés plates laiton nickelé réversibles avec carte de propriété. *dipped zinc-plated arched steel lock case and strike plate mount. Alloy lock case and strike plate cover. Chrome-plated satin finish steel lock bolt. Cylinder protected against pull out through pillar and staple. Brass backset. 6 pin brass cylinder. Anti-picking pins. Protection against drilling through a first hardened steel pin. 4 reversible nickel-plated brass cylinder keys with personal card.* Soporte de caja y gacheta de acero arqueada cincada. Capó de caja y gacheta de aleación. Pestillo de acero cromado satén. Protección contra el desgarramiento del

cilindro por pilar y puente. Entrada de latón. Cilindro de latón de 6 pasadores. Pasadores anti-forzado. Protección contra la perforación por primer pasador de acero templado. 4 llaves planas de latón niquelado. reversibles con tarjeta personal.

Finition/Finish/Acabado

Epoxy bronze, argent, noir, blanc
Bronze, silver, black, and white epoxy
Epoxi bronce, plata, negro, blanco

Version/Option/Versión

A bouton
With knob
Con botón

Utilisation/Use/Utilización

Porte d'entrée vitrée
Glass entrance door
Puerta de entrada acristalada

Designation	Boite	Colis.	Prix	Sachet	Colis.	Prix	Brochable					Colis.	Prix
							France	Euro 1	Euro 2	Euro 3	Euro 4		
UNIVERSEL 6 goup. à double cylindre Ø 23 x 45 mm bronze 4 clés	00082451	1	-	-	-	-	00382451	00393192 NS	-	00394192	-	2	-
UNIVERSEL 6 goup. à double cylindre Ø 23 x 45 mm argent 4 clés	00082452	1	-	-	-	-	00382452	00393193 NS	-	00394193	-	2	-
UNIVERSEL 6 goup. à double cylindre Ø 23 x 45 mm blanc 4 clés	00082453	1	-	-	-	-	00382453	00393194 NS	-	00394194	-	2	-
UNIVERSEL 6 goup. à double cylindre Ø 23 x 45 mm noir 4 clés	00082454	1	-	-	-	-	00382454	00393195 NS	-	00394195	-	2	-

NS Non stocké/Non-stored/Producto no estocado - ☐ Sur stock Europe Zone 1 et Zone 2, nous consulter pour délai d'approvisionnement - ☒ Epuisement/Stock depletion/Agotamiento del stock

Verrou de sûreté / UNIVERSEL A LANGUETTE

PROTECT

Cylindre ajustable à languette de 35 à 80mm



NIVEAU DE SÉCURITÉ



MODÈLE DÉPOSÉ PROTÉGÉ



10 ans

GARANTIE



X 5



Remplace les verrous existants, sans nouveau perçage



Un tournevis suffit !

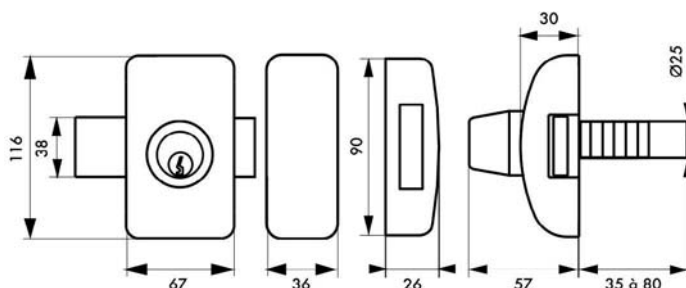

Description/Description/Descripción

Supports de coffre et gâche en acier cambré zingué. Capots de coffre et gâche en alliage. Pêne acier chromé satin. Cylindre laiton à languette 8 goupilles. Protection contre le perçage par première goupille en acier trempé. Entrée laiton. 5 clés plates laiton nickelé réversibles avec carte de propriété.

Zinc plated arched steel lock case and strike plate mount. Alloy lock case and strike plate cover. Chrome-plated satin finish steel lock bolt. Brass backset. 8 pins brass cylinder. Anti-picking pins. Protection against drilling through a first hardened steel pin. 5 reversible nickel-plated brass cylinder keys with personal card.

Soporte de caja y gacheta de acero arqueado cincado.

Capó de caja y gacheta de aleación. Pestillo de acero cromado satin. Protección contra el desgarramiento del cilindro por pilar y puente. Entrada de latón. Cilindro de latón de 8 pasadores. Protección contra la perforación por primer pasador de acero templado. 5 llaves planas de latón niquelado reversibles con tarjeta personal.

Finition/Finish/Acabado

Epoxy bronze, argent, noir, blanc
Bronze, silver, black, and white epoxy
Epoxi bronce, plata, negro, blanco

Utilisation/Use/Utilización

Porte d'entrée vitrée
Glass entrance door
Puerta de entrada acristalada

Designation	Boite	Colis.	Prix	Sachet	Colis.	Prix	Brochable					Colis.	Prix
							France	Euro 1	Euro 2	Euro 3	Euro 4		
UNIVERSEL TRANSIT 2 à double cyl. Ø 25 mm à languette bronze 5 clés réversibles	00080444	1	-	-	-	-	00380444	-	-	-	-	2	-
UNIVERSEL TRANSIT 2 à double cyl. Ø 25 mm à languette argent 5 clés réversibles	00080445	1	-	-	-	-	00380445	-	-	-	-	2	-
UNIVERSEL TRANSIT 2 à double cyl. Ø 25 mm à languette blanc 5 clés réversibles	00080446	1	-	-	-	-	00380446	-	-	-	-	2	-
UNIVERSEL TRANSIT 2 à double cyl. Ø 25 mm à languette noir 5 clés réversibles	00080447	1	-	-	-	-	00380447	-	-	-	-	2	-

Non stocké/Non-stored/Producto no estocado - Sur stock Europe Zone 1 et Zone 2, nous consulter pour délai d'approvisionnement - Epuement/Stock depletion/Agotamiento del stock

Verrou de sûreté / APACHE

RESIST



NIVEAU DE SÉCURITÉ



GARANTIE



X 3



Entraxe standard
pour la rénovation

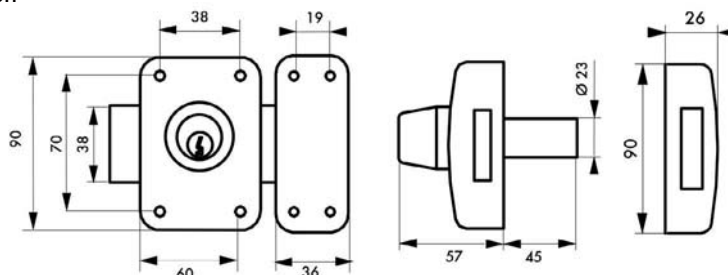

Description/Description/Descripción

Coffre en acier embouté. Gâche en acier embouté. Pêne acier chromé. Cylindre laiton à 5 goupilles. Protection contre l'arrachement du cylindre par pilier et cavalier. Pêne interchangeable. Entrée laiton. 3 clés acier.
Pressed steel lock case. Pressed steel strike plate. Chrome-plated steel lock bolt. 5-pin brass cylinder. Cylinder protected against pull out through pillar and staple. Brass key hole plate. 3 steel keys.
Caja de acero embutido. Gacheta de acero embutido. Pestillo de acero cromado. Cilindro de latón de 5 pasadores. Protección contra el desgarramiento del cilindro por pilar y caballete. Entrada de latón. 3 llaves de acero.

Finition/Finish/Acabado

Epoxy or
Gold epoxy
Epoxi dorado

Version/Option/Versión

A bouton. Sans cylindre extérieur, sans bouton. Pour cylindre profilé. Pêne 140 mm pour porte à recouvrement
With knob. Without knob. Without outside cylinder. Bolt 140 mm for covering door frame.
Con botón. Sin botón. Sin cilindro exterior. Pestillo 140 mm para puerta que recubre el marco.

Utilisation/Use/Utilización

Porte d'entrée vitrée
Glass entrance door
Puerta de entrada acristalada

Designation	Boite	Colis.	Prix	Sachet	Colis.	Prix	Brochable					Colis.	Prix
							France	Euro 1	Euro 2	Euro 3	Euro 4		
APACHE à double cylindre Ø 23 x 45 mm époxy or 3 clés	-	-	-	00992501	5	-	00292501	-	-	00294187	-	5	-
APACHE à double cylindre Ø 23 x 45 mm huisserie métallique 3 clés	-	-	-	-	-	-	00292581	-	-	-	-	5	-
APACHE à double cylindre Ø 23 x 45 mm avec plaque de renfort 3 clés	-	-	-	-	-	-	00392571	-	-	-	-	5	-
APACHE à double cylindre Ø 23 x 60 mm époxy or 3 clés	-	-	-	00992561	5	-	00292561	-	-	-	-	5	-

⚠ Non stocké/Non-stored/Producto no estocado - 📦 Sur stock Europe Zone 1 et Zone 2, nous consulter pour délai d'approvisionnement - 📦 Epuisement/Stock depletion/Agotamiento del stock

Verrou de sûreté / RAFALE RESIST



GARANTIE



X 3



Verrou double fixation brevetée pour une protection contre l'arrachement

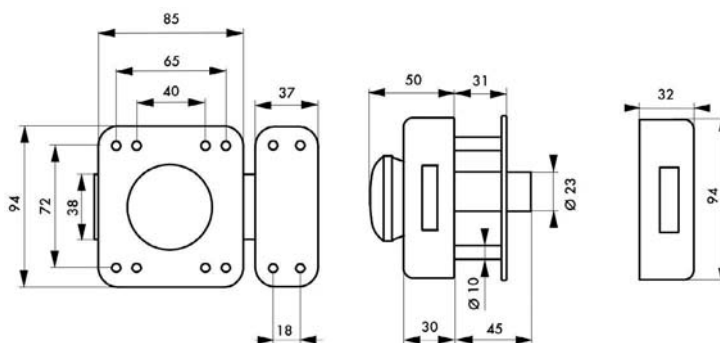

Description/Description/Descripción

Coffre acier embouti. Gâche acier embouti. Pêne acier nickelé. Mécanisme intérieur renforcé. (brevet déposé). Double fixation sur coffre à 8 vis. (brevet déposé). Plaque de renfort. Cylindre laiton à 5 goupilles. Entrée laiton. 3 clés en acier nickelé.

Pressed steel case and striker. Nickel plated steel bolt. Strong inner mechanism (patent registered). Double fixing with 8 screws on case (patent registered). Strengthening plate. 5 pin brass cylinder. Brass key hole plate. 3 nickel plated steel keys.

Caja de acero embutido. Cerradero de acero embutido. Pestillo de acero niquelado. Mecanismo interior reforzado. (patente registrada). Doble fijación en caja con 8 tornillos (patente registrada). Placa de refuerzo. Cilindro de latón de 5 pasadores. Entrada latón. 3 llaves de acero niquelado

Finition/Finish/Acabado

Epoxy bronze
Bronze epoxy
Epoxi bronze

Versión/Option/Versión

A bouton. Boîtier avec pêne alliage nickelé pour cylindre profilé.

With knob. For profile cylinder.

Con botón. Caja con pestillo de aleación niquelada para cilindro perfilado.

Utilisation/Use/Utilización

Porte d'entrée vitrée
Glass entrance door
Puerta de entrada acristalada

Designation	Boite	Colis.	Prix	Sachet	Colis.	Prix	Brochable					Colis.	Prix
							France	Euro 1	Euro 2	Euro 3	Euro 4		
RAFALE à double cylindre Ø 23 x45 mm epoxy bronze 3 clés	00005020	1	-	-	-	-	00305020 E NS	-	-	-	-	5	-

Non stocké/Non-stored/Producto no estocado - Sur stock Europe Zone 1 et Zone 2, nous consulter pour délai d'approvisionnement - Epuisement/Stock depletion/Agotamiento del stock

Verrou de haute sûreté / TRANSIT 2 RESIST



GARANTIE



X 4



Possibilité de fabriquer
des cylindres ou verrous
sur le même numéro.
Foncet vissé démontable



Foncet vissé
démontable

Description/Description/Descripción

Coffre en acier embouti. Gâche en acier embouti. Pêne acier chromé. Cylindre à 8 goupilles maillechort. Protection contre le perçage par première goupille en acier trempé. Protection contre l'arrachement par pilier et cavalier. 4 clés plates laiton nickelé réversibles avec carte de propriété.

Pressed steel case and striker. Chrome plated steel bolt. 6 pin brass cylinder. Protection against drilling by hardened steel pin. Safety device against drawing the cylinder by rider and pillar. 4 nickel plated brass reversible keys with owner card allowing key duplication in factory.

Caja de acero embutido. Cerradero de acero embutido. Pestillo de acero cromado. Cilindro de 6 pasadores de alpaca. Protección contra el taladrado por el primer pasador de acero templado.

Protección contra el arrancamiento por pilar y puente. 4 llaves de latón niquelado reversibles con tarjeta de propiedad para la reproducción de las llaves en fábrica.

Finition/Finish/Acabado

Epoxy or
gold epoxy
Epoxi dorado

Version/Option/Versión

A bouton
With knob
Con botón

Utilisation/Use/Utilización

Porte d'entrée vitrée
Glass entrance door
Puerta de entrada acristalada

Verrou de haute sûreté / TRANSIT 2 RESIST

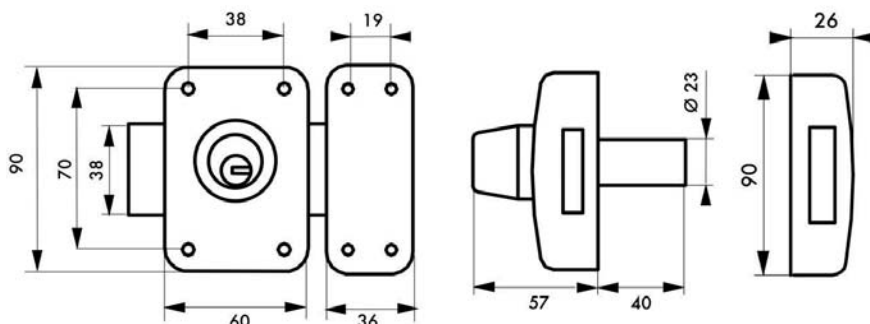

Designation	Boite	Colis.	Prix	Sachet	Colis.	Prix	Brochable					Colis.	Prix
							France	Euro 1	Euro 2	Euro 3	Euro 4		
TRANSIT 2 à double cylindre Ø 23 x40 mm époxy or 4 clés réversibles	00007620	1	-	-	-	-	-	-	-	-	-	-	-
TRANSIT 2 à double cylindre Ø 23 x45 mm époxy or 4 clés réversibles	00017620	1	-	00917620	10	-	00317620	-	-	-	-	2	-
TRANSIT 2 à double cylindre Ø 23 x50 mm époxy or 4 clés réversibles	00027620	1	-	-	-	-	-	-	-	-	-	-	-
TRANSIT 2 à double cylindre Ø 23 x60 mm époxy or 4 clés réversibles	00047620	1	-	-	-	-	-	-	-	-	-	-	-
TRANSIT 2 à double cylindre Ø 23 x65 mm époxy or 4 clés réversibles	00057620	1	-	-	-	-	-	-	-	-	-	-	-
TRANSIT 2 à double cylindre Ø 23 x70 mm époxy or 4 clés réversibles	00067620	1	-	-	-	-	-	-	-	-	-	-	-
TRANSIT 2 à double cylindre Ø 23 x75 mm époxy or 4 clés réversibles	00077620	1	-	-	-	-	-	-	-	-	-	-	-
TRANSIT 2 à double cylindre Ø 23 x80 mm époxy or 4 clés réversibles	00087620 <small>NS</small>	1	-	-	-	-	-	-	-	-	-	-	-
TRANSIT 2 à double cylindre Ø 23 x85 mm époxy or 4 clés réversibles	00097620 <small>NS</small>	1	-	-	-	-	-	-	-	-	-	-	-
TRANSIT 2 à double cylindre Ø 23 x90 mm époxy or 4 clés réversibles	00117620 <small>NS</small>	1	-	-	-	-	-	-	-	-	-	-	-
TRANSIT 2 à double cylindre Ø 23 x95 mm époxy or 4 clés réversibles	00127620 <small>NS</small>	1	-	-	-	-	-	-	-	-	-	-	-
TRANSIT 2 à double cylindre Ø 23 x100 mm époxy or 4 clés réversibles	00137620 <small>NS</small>	1	-	-	-	-	-	-	-	-	-	-	-

NS Non stocké/Non-stored/Productos no estocado - ■ Sur stock Europe Zone 1 et Zone 2, nous consulter pour délai d'approvisionnement - E Epuement/Stock depletion/Agotamiento del stock

Verrou de sûreté / CAPITAL RESIST



NIVEAU DE SÉCURITÉ



GARANTIE



X 3



Foncet vissé
démontable

Description/Description/Descripción

Coffre et gâche acier embouti. Pêne acier chromé mat. Cylindre laiton à 5 goupilles type HG5. Protection contre l'arrachement du cylindre. par pilier et cavalier (sauf cylindre de 30 mm). Pêne interchangeable. Entrée laiton - 3 clés en acier nickelé.

Pressed steel case. Pressed steel striker. Dull chrome plated steel bolt. 5 pin brass cylinder. Safety device against drawing the cylinder by rider and pillar (except cylinder 30 mm). Brass key hole plate. 3 nickel plated steel keys.

Caja de acero embutido. Cerradero de acero embutido. Pestillo de acero cromado mate. Cilindro de latón con 5 pasadores. Protección contra el arrancamiento del cilindro mediante pilar y caballete (excepto cilindro 30 mm). Entrada de latón. 3 llaves de acero niquelado.

Finition/Finish/Acabado

Epoxy or
gold epoxy
Epoxi dorado

Version/Option/Versión

A bouton. Sans bouton. Avec pêne 160 mm cylindre 30 mm pour porte de garage. Sans cylindre extérieur. Pour cylindre profilé. Avec pêne alliage nickelé. Montage sur organigramme compatible HG5. Autres longueurs de cylindre sur demande.

Double cylinder. With 160 mm bolt and 30 mm length cylinder for garage door. Without outside cylinder. Doble cilindro. Con pestillo 160 mm cilindro 30 mm para puerta de garaje. Sin cilindro exterior.

Utilisation/Use/Utilización

Porte d'entrée vitrée
Glass entrance door
Puerta de entrada acristalada

Verrou de sûreté / CAPITAL RESIST



NIVEAU DE SÉCURITÉ

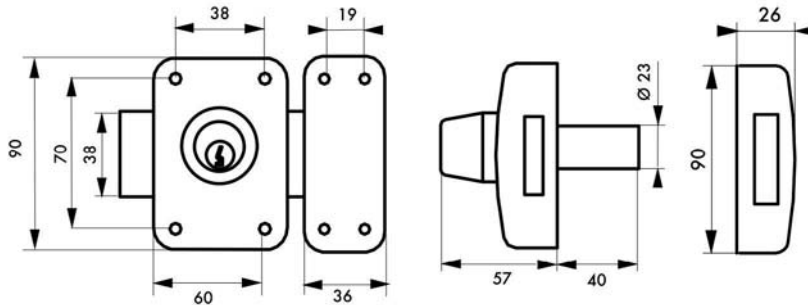

Designation	Boite	Colis.	Prix	Sachet	Colis.	Prix	Brochable					Colis.	Prix
							France	Euro 1	Euro 2	Euro 3	Euro 4		
CAPITAL à double cylindre Ø 23 x40 mm époxy or 3 clés	00091320	1	-	-	-	-	-	-	-	-	-	-	-
CAPITAL à double cylindre Ø 23 x45 mm époxy or 3 clés	00092320	1	-	-	-	-	-	-	-	-	-	-	-
CAPITAL à double cylindre Ø 23 x50 mm époxy or 3 clés	00093320	1	-	-	-	-	-	-	-	-	-	-	-
CAPITAL à double cylindre Ø 23 x60 mm époxy or 3 clés	00092306	1	-	-	-	-	-	-	-	-	-	-	-
CAPITAL à double cylindre Ø 23 x70 mm époxy or 3 clés	00092370	1	-	-	-	-	-	-	-	-	-	-	-
CAPITAL à double cylindre Ø 23 x80 mm époxy or 3 clés	00092371	1	-	-	-	-	-	-	-	-	-	-	-
CAPITAL à double cylindre Ø 23 x90 mm époxy or 3 clés	00092372	1	-	-	-	-	-	-	-	-	-	-	-
CAPITAL à double cylindre Ø 23 x100 mm époxy or 3 clés	00092373	1	-	-	-	-	-	-	-	-	-	-	-
CAPITAL à double cylindre Ø 23 x100 mm époxy or 3 clés	00092374	1	-	-	-	-	-	-	-	-	-	-	-
CAPITAL à double cylindre Ø 23 x120 mm époxy or 3 clés	00092375	1	-	-	-	-	-	-	-	-	-	-	-

Tarif conditionnement non décollable

CAPITAL à double cylindre Ø 23 x40 mm époxy or 3 clés	00091325	25	-	-	-	-	-	-	-	-	-	-	-
CAPITAL à double cylindre Ø 23 x45 mm époxy or 3 clés	00092325	25	-	-	-	-	-	-	-	-	-	-	-
CAPITAL à double cylindre Ø 23 x50 mm époxy or 3 clés	00093325	25	-	-	-	-	-	-	-	-	-	-	-

☒ Non stocké/Non-stored/Productos no estocado - ☑ Sur stock Europe Zone 1 et Zone 2, nous consulter pour délai d'approvisionnement - ☒ Epuement/Stock depletion/Agotamiento del stock

Verrou de haute sûreté / SURVEYOR RESIST



NIVEAU DE SÉCURITÉ



GARANTIE



X 4



Protecteur de cylindre + plaque de renfort pour une sécurité accrue.

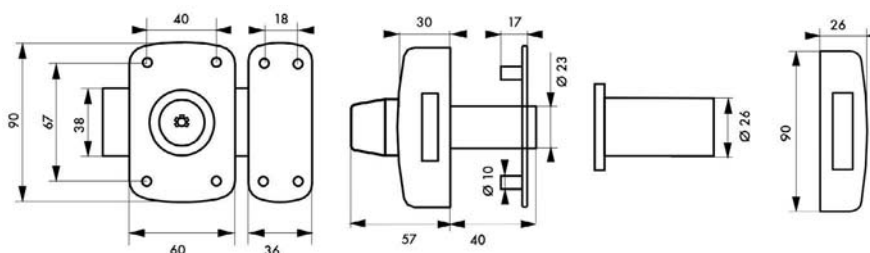

Description/Description/Descripción

Coffre en acier embouti. Gâche en acier embouti. Pêne acier chromé. Cylindre laiton à pompes à 5 éléments de verrouillage. Protecteur de cylindre en acier cémenté, contre le perçage et l'arrachement. Plaque de renfort en alliage moulé. 4 clés à insert laiton avec carte personnelle.

Pressed steel case. Pressed steel striker. Chrome plated steel bolt. Tumblers brass cylinder. Hardened steel guard cylinder against drilling and tearing off. Strengthening plate. 4 keys in insert brass and patent registered keys with owner card allowing key duplication only in factory.
Caja de acero embutido. Cerradero de acero embutido. Pestillo de acero cromado. Cilindro de latón de bombas. Protector de cilindro de acero cementado contra el taladrado y el arrancamiento. Placa de refuerzo de aleación. 4 llaves con inserción de latón y tarjeta de propiedad para la reproducción de las llaves en fábrica.

Finition/Finish/Acabado

Epoxy bronze

Bronze epoxy

Epoxi bronce

Versión/Option/Versión

A bouton. Verrou EMERAUDE sans protecteur de cylindre, sans plaque de renfort, 3 clés.

With knob. EMERAUDE without guard and without strengthening plate, 3 keys.

Con botón. Cerrojo EMERAUDE sin protector de cilindro y sin placa de refuerzo de aleación, 3 llaves

Utilisation/Use/Utilización

Porte d'entrée vitrée

Glass entrance door

Puerta de entrada acristalada

Designation	Boite	Colis.	Prix	Sachet	Colis.	Prix	Brochable					Colis.	Prix
							France	Euro 1	Euro 2	Euro 3	Euro 4		
SURVEYOR à double cylindre à pompes Ø 23 x40 mm epoxy bronze 4 clés	00007020	1	-	-	-	-	00307020	-	-	-	-	2	-
SURVEYOR à double cylindre à pompes Ø 23 x45 mm epoxy bronze 4 clés	00017020	1	-	-	-	-	00317020	-	-	-	-	2	-

⚠ Non stocké/Non-stored/Producto no estocado - 📦 Sur stock Europe Zone 1 et Zone 2, nous consulter pour délai d'approvisionnement - 📦 Epuisement/Stock depletion/Agotamiento del stock

Verrou de sûreté / ATLANTIC M RESIST



NIVEAU DE SÉCURITÉ



GARANTIE



X 4



Clés réversibles et protection anti
crochetage et anti percage.



Foncet vissé
démontable

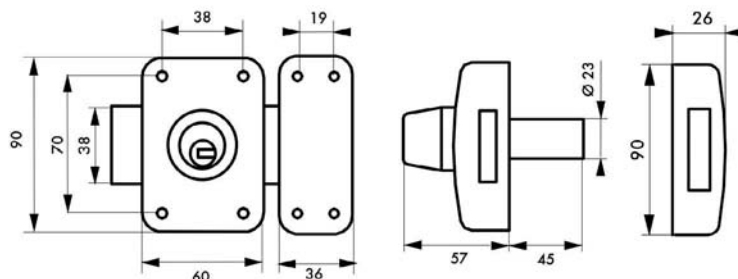

Description/Description/Descripción

Coffre en acier embouti. Gâche en acier embouti. Pêne acier chromé satin. Cylindre laiton 9 à 19 goupilles maillechort. Goupilles anti-crochetage. Protection contre le percage par première goupille en acier trempé. Protection contre l'arrachement du cylindre par pilier et cavalier. 4 clés plates maillechort réversibles brevetées avec carte de propriété permettant la reproduction des clés exclusivement en usine. Pièces mobiles dans la clé interdisant toute reproduction hors usine.

Pressed steel lock case. Pressed steel strike plate. Satin chrome-plated finish steel lock bolt. Brass cylinder with 9 to 19 nickel silver pins. Anti-picking pins. Protection against drilling through a first hardened steel pin. Cylinder protected against pull out through pillar and staple. 4 patented reversible nickel silver keys with property card allowing exclusive key reproduction in the factory. - Moving parts in the key that prohibit any reproduction off factory.
Caja de acero embutido. Gacheta de acero embutido. Pestillo de acero cromado satén. Cilindro de latón 9 a 19 pasadores maillechort. Pasadores anti-forzado. Protección contra la perforación por primer pasador de acero

templado. Protección contra el desgarramiento del cilindro por pilar y puente. 4 llaves planas maillechort reversibles patentadas con tarjeta de propiedad que permite la reproducción de las llaves exclusivamente en fábrica. - Piezas móviles en la llave que prohíben cualquier reproducción fuera de fábrica.

Finition/Finish/Acabado

Epoxy or
gold epoxy
Epoxi dorado

Version/Option/Versión

A bouton
With knob
Con botón

Utilisation/Use/Utilización

Porte d'entrée vitrée
Glass entrance door
Puerta de entrada acristalada

Designation	Boite	Colis.	Prix	Sachet	Colis.	Prix	Brochable				Colis.	Prix	
							France	Euro 1	Euro 2	Euro 3			Euro 4
ATLANTIC M à double cylindre $\varnothing 23 \times 45$ mm époxy or 4 clés	00092504	1	-	-	-	-	00392504	-	-	-	-	2	-

Non stocké/Non-stored/Producto no estocado - Sur stock Europe Zone 1 et Zone 2, nous consulter pour délai d'approvisionnement - Epuement/Stock depletion/Agotamiento del stock

Verrou de haute sûreté / FEDERAL RESIST



NIVEAU DE SÉCURITÉ



MODÈLE DÉPOSÉ ET PROTÉGÉ



GARANTIE



X 4



Mécanisme magnétique protégé contre larrachement, le crochetage et le perçage.



Foncet vissé démontable

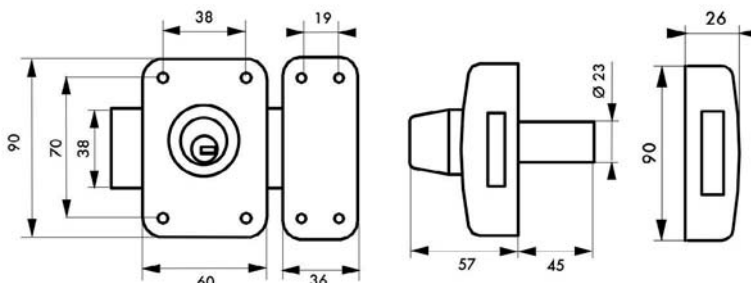

Description/Description/Descripción

Coffre en acier embouti. Gâche en acier embouti. Pêne acier chromé satin. Cylindre laiton de 4 à 5 doubles goupilles télescopiques. Goupilles anti-crochetage. Protection contre le perçage par première goupille en acier trempé. Protection contre l'arrachement du cylindre par pilier et cavalier. 4 clés plates réversibles maillechort avec anneau ergonomique moulé, avec carte de propriété permettant la reproduction des clés exclusivement en usine. Mécanisme magnétique interdisant toute reproduction hors usine.

Pressed steel lock case. Pressed steel strike plate.

Chrome-plated satin finish steel lock bolt. Magnetic 4 to 5 double telescopic pin mechanism. Anti-picking pins. Protection against drilling through a first hardened steel pin. Cylinder protected against pull out through pillar and staple. 4 nickel-plated brass keys with ABS insert and property card allowing exclusive key reproduction in the factory. Caja de acero embutido. Gacheta de acero embutido.

Pestillo de acero cromado satiné. Cilindro de latón de 4 a 5 dobles pasadores. Pasadores anti-forzado. Protección contra la perforación por primer pasador de acero templado. Protección contra el desgarramiento del cilindro por pilar y puente. 4 llaves de latón niquelado con inserto ABS y tarjeta de propiedad que permite la reproducción de las llaves exclusivamente en fábrica.

Finition/Finish/Acabado

Epoxy or gold epoxy
Epoxi dorado

Version/Option/Versión

A bouton
With knob
Con botón

Utilisation/Use/Utilización

Porte d'entrée vitrée
Glass entrance door
Puerta de entrada acristalada

Designation	Boite	Colis.	Prix	Sachet	Colis.	Prix	Brochable					Colis.	Prix
							France	Euro 1	Euro 2	Euro 3	Euro 4		
FEDERAL à double cylindre Ø 23 x45 mm époxy or 4 clés	00092507	1	-	-	-	-	00392507	-	-	-	-	2	-

⚠ Non stocké/Non-stored/Producto no estocado - 📦 Sur stock Europe Zone 1 et Zone 2, nous consulter pour délai d'approvisionnement - 🇪🇺 Epuisement/Stock depletion/Agotamiento del stock

Verrou de haute sûreté / COBRA RESIST



NIVEAU DE SÉCURITÉ



GARANTIE



X 4



Clés type coffre-fort, protecteur et plaque de renfort pour une protection renforcée

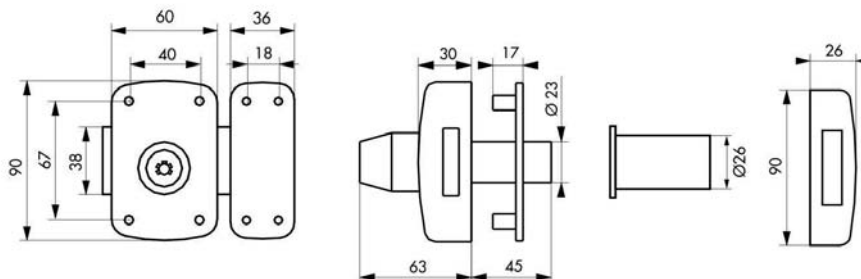

Description/Description/Descripción

Coffre en acier embouti. Gâche en acier embouti. Pêne acier chromé. Bouton ABS chromé. Cylindre laiton chromé à 5 pompes axiales et avec dispositif pompe contre-pompe radiale contre le crochetage. Protecteur de cylindre en acier cémenté contre le perçage et l'arrachement. Plaque de renfort en alliage moulé. 4 clés brevetées à reproduction interdite avec carte de propriété pour la reproduction des clés en usine.

Pressed steel case and striker. Chrome plated steel bolt. Chrome plated ABS knob. Chrome plated brass cylinder with 5 axial tumblers and radial security mechanism. Hardened steel guard cylinder against drilling and tearing off. Strengthening plate. 4 patent registered keys with owner card allowing key duplication only in factory.
Caja de acero embutido. Cerradero de acero embutido. Pestillo de acero cromado. Botón de ABS cromado. Cilindro de latón cromado con 5 bombas axiales y con dispositivo de bomba y contrabomba radial. Protector de cilindro de acero cementado contra el taladrado y el arrancamiento.

Finition/Finish/Acabado

Epoxy bronze
Bronze epoxy
Epoxi bronce

Version/Option/Versión

A bouton
With knob
Con botón

Utilisation/Use/Utilización

Porte d'entrée vitrée
Glass entrance door
Puerta de entrada acristalada

Designation	Boîte	Colis.	Prix	Sachet	Colis.	Prix	Brochable					Colis.	Prix
							France	Euro 1	Euro 2	Euro 3	Euro 4		
COBRA à double cylindre 45 mm époxy bronze 4 clés	M11007420	1	-	-	-	-	M1307420	-	-	-	-	2	-

Non stocké/Non-stored/Producto no estocado - Sur stock Europe Zone 1 et Zone 2, nous consulter pour délai d'approvisionnement - Epuement/Stock depletion/Agotamiento del stock

Verrou de haute sûreté / TRANSIT 2 A2P* *

RESIST



GARANTIE



X 4

Verrou de haute sûreté
breveté reconnu par les
sociétés d'assurances

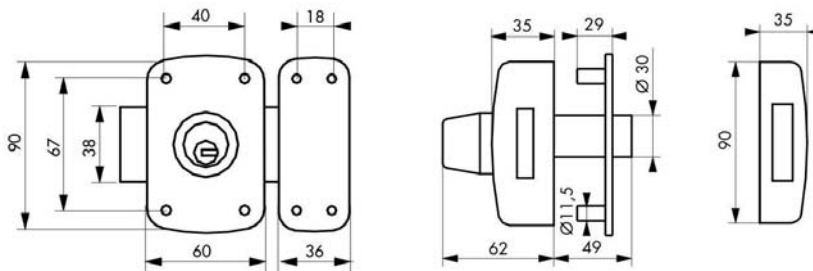

Description/Description/Descripción

Coffre et gâche en acier embouti. Pêne acier cémenté trempé nickelé. Cylindre à 8 goupilles en acier trempé. Cabochon de protection du cylindre en acier zingué. Plaque de blindage du coffre en acier. Plaque de renfort extérieure en acier. 4 clés plates laiton nickelé réversibles avec carte de propriété dans un emballage scellé pour la reproduction des clés en usine.

Pressed steel case and striker. Hardened nickel plated steel bolt. 8 hardened steel pin brass cylinder. Zinc steel cylinder guard. Steel armour plate for the casehardened steel strengthening plate. 4 nickel plated brass reversible keys with owner card in a sealed packing allowing key duplication in factory.

Caja y cerradero de acero embutido. Pestillo de acero cementado templado niquelado. Cilindro con 8 pistones de acero templado. Cabujón de protección del cilindro de acero cincado. Placa de blindaje de la caja de acero. Placa de refuerzo exterior de acero cementado. 4 llaves de latón niquelado reversibles con tarjeta de propiedad en un embalaje sellado para la reproducción de las llaves en fábrica.

Finition/Finish/Acabado

Epoxy bronze
Bronze epoxy
Epoxi bronce

Version/Option/Versión

A bouton
With knob
Con botón

Utilisation/Use/Utilización

Porte d'entrée vitrée
Glass entrance door
Puerta de entrada acristalada

Designation	Boite	Colis.	Prix	Sachet	Colis.	Prix	Brochable					Colis.	Prix
							France	Euro 1	Euro 2	Euro 3	Euro 4		
TRANSIT 2 A2P* à double cylindre 45 mm époxy bronze 4 clés	00098620	1	-	-	-	-	00398620	-	-	-	-	2	-

⚠ Non stocké/Non-stored/Producto no estocado - 📦 Sur stock Europe Zone 1 et Zone 2, nous consulter pour délai d'approvisionnement - 📦 Epuisement/Stock depletion/Agotamiento del stock

Verrou de haute sûreté / ADRIATIC 2 A2P *

RESIST



GARANTIE



X 4



Verrou de haute sûreté
breveté reconnu par les
sociétés d'assurances

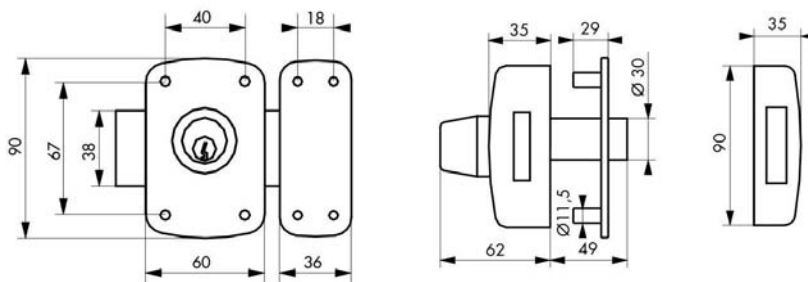

Description/Description/Descripción

Coffre en acier embouti. Gâche en acier embouti. Pêne acier chromé. Cylindre laiton de 6 à 22 goupilles sur 5 rangées. Goupilles en acier trempé anti-crochetage. Cabochon de protection du cylindre en acier zingué. Plaque de blindage du coffre en acier. Plaque de renfort extérieure en acier. 4 clés laiton nickelé avec insert ABS, avec carte de propriété permettant la reproduction des clés exclusivement en usine. Pièce mobile anti-crochetage interne au cylindre interdisant toute reproduction hors usine.

Pressed steel lock case. Pressed steel strike plate. Chrome-plated steel lock bolt. Brass cylinder with 6 to 22 pins on 5 rows. Anti-picking hardened steel pins. Zinc-plated steel protective cabochon for cylinder. Lock case steel armor plate. Exterior steel reinforcing plate. 4 nickel-plated brass keys with ABS insert and property card allowing exclusive key reproduction in the factory. Caja de acero embutido. Gacheta de acero embutido. Pestillo de acero cromado. Cilindro de latón de 6 a 22

pasadores sobre 5 hileras. Pasadores de acero templado anti-forzado. Capuchón de protección del cilindro de acero cincado. Placa de blindaje de la caja de acero Placa de refuerzo exterior de acero. 4 llaves de latón niquelado con inserto ABS y tarjeta de propiedad que permite la reproducción de las llaves exclusivamente en fábrica.

Finition/Finish/Acabado

Epoxy bronze
Bronze epoxy
Epoxi bronçe

Versión/Option/Versión

A bouton
With knob
Con botón

Utilisation/Use/Utilización

Porte d'entrée vitrée
Glass entrance door
Puerta de entrada acristalada

Designation	Boite	Colis.	Prix	Sachet	Colis.	Prix	Brochable					Colis.	Prix
							France	Euro 1	Euro 2	Euro 3	Euro 4		
ADRIATIC A2P* à double cylindre 45 mm epoxy bronze 4 clés	00092530	1	-	-	-	-	00392530	-	-	-	-	2	-

Non stocké/Non-stored/Producto no estocado - Sur stock Europe Zone 1 et Zone 2, nous consulter pour délai d'approvisionnement - Epuement/Stock depletion/Agotamiento del stock

Verrou de sûreté / CONCORDE

ECO

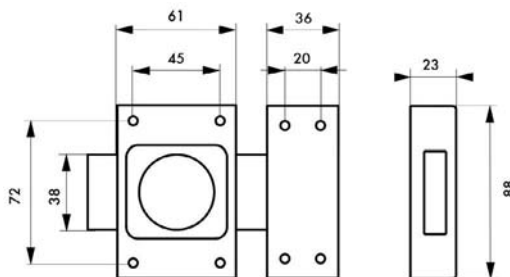

GARANTIE

Description/Description/Descripción

Coffre acier cambré. Gâche acier cambré. Pêne acier nickelé. Bouton ABS chromé.

Cambered steel case. Cambered steel striker. Nickel plated steel bolt. Chrome plated ABS knob.

Caja de acero curvado. Cerradero de acero curvado. Pestillo de acero niquelado. Botón de ABS cromado.

Finition/Finish/Acabado

Epoxy bronze

Bronze epoxy

Epoxi bronce

Version/Option/Versión

Double cylindre. Sans cylindre à bouton.

Boitier avec pêne alliage nickelé pour cylindre profilé.

Double cylinder. Without cylinder with knob.

For profile cylinder.

Doble cilindro. Sin cilindro de botón. Caja para cilindro perfilado.

Utilisation/Use/Utilización

Porte d'intérieur

Inside door

Puerta interior

Designation	Boite	Colis.	Prix	Sachet	Colis.	Prix	Brochable					Colis.	Prix
							France	Euro 1	Euro 2	Euro 3	Euro 4		
Verrou automatique CONCORDE	00001000	1	-	-	-	-	00201000	-	-	-	-	5	-

Verrou de sûreté / TRIDENT

ECO

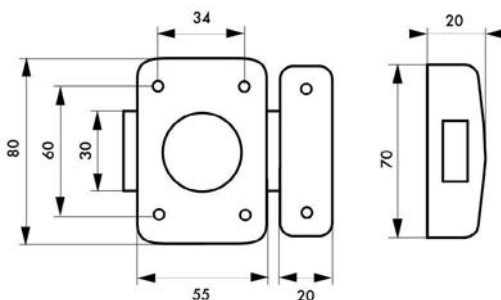

GARANTIE

Description/Description/Descripción

Coffre acier embouti. Gâche acier embouti. Pêne acier nickelé. Bouton ABS chromé.

Pressed steel case, striker. Nickel plated steel bolt.

Chrome plated ABS knob

Caja de acero embutido. Gacheta de acero embutido.

Pestillo de acero niquelado. Botón de ABS cromado.

Finition/Finish/Acabado

Epoxy bronze

Bronze epoxy

Epoxi bronce

Version/Option/Versión

A bouton et cylindre

With knob and cylinder

Con botón y cilindro

Utilisation/Use/Utilización

Porte d'intérieur

Inside door

Puerta interior

Designation	Boite	Colis.	Prix	Sachet	Colis.	Prix	Brochable					Colis.	Prix
							France	Euro 1	Euro 2	Euro 3	Euro 4		
Verrou automatique TRIDENT	00002000	1	-	00902000	5	-	00202000	-	-	-	-	5	-

Verrou de sûreté / VSPM

ECO



00999956

00900956



NIVEAU DE SÉCURITÉ



GARANTIE



X 3

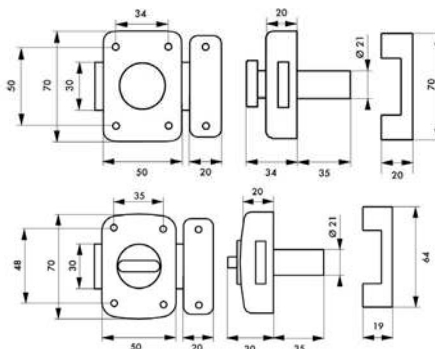

Description/Description/Descripción

Coffre acier embouté. Gâche acier embouté. Pêne acier nickelé. Bouton ABS chromé. Cylindre acier laiton à 5 goupilles. 3 clés nickelé. Entrée laiton.

Pressed steel case, striker. Nickel plated steel bolt.

Chrome plated ABS knob. 5 pin brass cylinder, 3 keys.

Caja de acero prensado. Cerradura manguito. Cierre mediante pestillo empujador. 3 llaves.

Finition/Finish/Acabado

Verni bronze

Bronze varnished

Bronce

Utilisation/Use/Utilización

Porte légère

Light door

Puerta ligera

Designation	Boite	Colis.	Prix	Sachet	Colis.	Prix	Brochable					Colis.	Prix
							France	Euro 1	Euro 2	Euro 3	Euro 4		
VSPM cylindre 35 mm petit coffre verni bronze 3 clés	-	-	-	00999956	10	-	00299956	-	-	-	-	5	-
VSPM cylindre 35 mm verni bronze 3 clés	-	-	-	00900956	10	-	-	-	-	-	-	-	-

Verrou de sûreté / ALOUETTE

ECO



NIVEAU DE SÉCURITÉ



GARANTIE



X 3

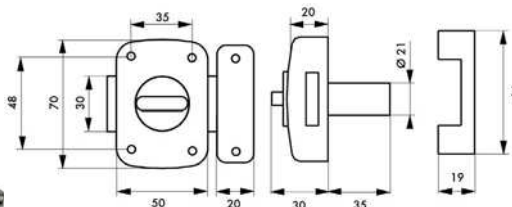

Description/Description/Descripción

Coffre en alliage moulé. Gâche en alliage moulé. Pêne en alliage chromé. Bouton ABS chromé. Cylindre laiton à 5 goupilles. 3 clés en acier nickelé. Entrée laiton.

Zinc alloy pressed case, striker. Chrome plated alloy bolt.

Chrome plated ABS knob. 5 pin brass cylinder, 3 keys.

Caja y cerradura de aleación moldeada. Pestillo de aleación cromado. Botón ABS cromado. Cilindro latón de 5 pasadores, 3 llaves.

Finition/Finish/Acabado

Epoxy bronze. Epoxy argent

Bronze epox. Silver epoxy.

Epoxi bronze. Epoxi plata.

Utilisation/Use/Utilización

Porte légère

Light door

Puerta ligera

Designation	Boite	Colis.	Prix	Sachet	Colis.	Prix	Brochable					Colis.	Prix
							France	Euro 1	Euro 2	Euro 3	Euro 4		
ALOUETTE cylindre 35 mm époxy bronze 3 clés	00000956	1	-	-	-	-	00200956	-	-	-	-	5	-
ALOUETTE cylindre 35 mm époxy argent 3 clés	00001957	1	-	00901957	10	-	00201957	-	-	-	-	5	-

Verrou de sûreté / TRIDENT ECO



NIVEAU DE SÉCURITÉ



GARANTIE



X 3

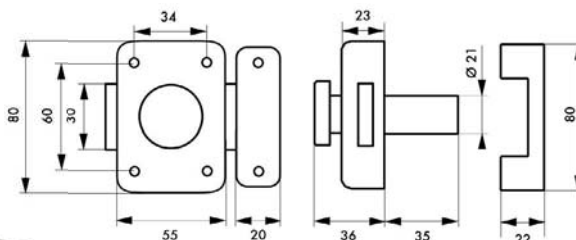

Description/Description/Descripción

Coffre en alliage moulé. Gâche en alliage moulé. Pêne en alliage chromé. Bouton ABS chromé. Cylindre laiton à 5 goupilles. 3 clés en acier nickelé. Entrée laiton.

Moulded alloy case, striker. Chrome plated alloy bolt. Chrome plated ABS knob. 5 pins brass cylinder. 3 nickel plated steel keys.

Caja y cerradura de aleación moldeada. Pestillo de aleación cromado. Botón ABS cromado. Cilindro latón de 5 pasadores. 3 llaves de acero niquelado. Entrada de latón.

Finition/Finish/Acabado

Epoxy bronze.

Bronze epoxy.

Epoxi bronze.

Utilisation/Use/Utilización

Porte légère

Light door

Puerta ligera

Designation	Boite	Colis.	Prix	Sachet	Colis.	Prix	Brochable					Colis.	Prix
							France	Euro 1	Euro 2	Euro 3	Euro 4		
TRIDENT cylindre 35 mm epoxy bronze 3 clés	-	-	-	00900945	5	-	00200945	-	-	-	-	5	-
TRIDENT cylindre 45 mm epoxy bronze 3 clés	-	-	-	00900946	5	-	00200946	-	-	-	-	5	-

Verrou de sûreté / CORVETTE PROTECT

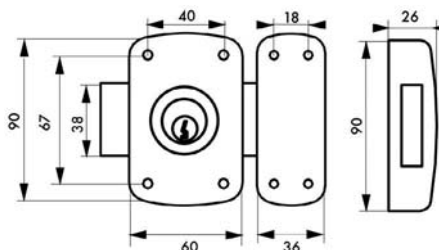

GARANTIE



X 3

Description/Description/Descripción

Coffre acier embouti. Gâche acier embouti. Pêne acier nickelé. 3 clés

Pressed steel case, striker. Nickel plated steel bolt. 3 keys

Caja de acero embutido. Gacheta de acero embutido.

Pestillo de acero niquelado. 3 llaves

Finition/Finish/Acabado

Epoxy bronze

Bronze epoxy

Epoxi bronze

Version/Option/Versión

Double cylindre. Sans cylindre à bouton.

Boîtier avec pêne alliage nickelé pour cylindre profilé.

Double cylinder. Without cylinder with knob.

For profile cylinder.

Doble cilindro. Sin cilindro de botón. Caja para cilindro perfilado.

Utilisation/Use/Utilización

Porte d'intérieur

Inside door

Puerta interior

Designation	Boite	Colis.	Prix	Sachet	Colis.	Prix	Brochable					Colis.	Prix
							France	Euro 1	Euro 2	Euro 3	Euro 4		
Verrou CORVETTE sans cylindre extérieur epoxy bronze 3 clés	00003920	1	-	-	-	-	00303920	-	-	-	-	5	-

Verrou de sûreté / APACHE RESIST

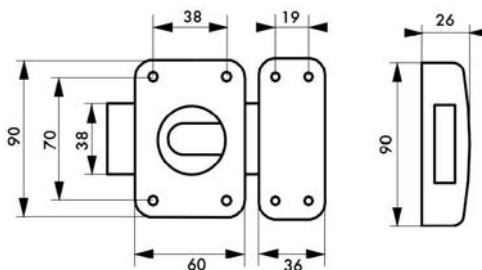

GARANTIE

Description/Description/Descripción

Coffre acier embouti. Gâche acier embouti. Pêne acier chromé mat. Bouton ABS chromé.

Pressed steel case, striker. Chrome plated steel bolt. Dull chrome plated ABS knob

Caja de acero embutido. Gacheta de acero embutido. Pestillo de acero cromado mate. Botón de ABS cromado.

Finition/Finish/Acabado

Epoxy or

Golden epoxy

Epoxi dorado

Version/Option/Versión

Double cylindre. Sans cylindre à bouton.

Boitier avec pêne alliage nickelé pour cylindre profilé.

Double cylinder. Without cylinder with knob.

For profile cylinder.

Doble cilindro. Sin cilindro de botón. Caja para cilindro perfilado.

Utilisation/Use/Utilización

Porte d'intérieur

Inside door

Puerta interior

Designation	Boite	Colis.	Prix	Sachet	Colis.	Prix	Brochable					Colis.	Prix
							France	Euro 1	Euro 2	Euro 3	Euro 4		
Verrou automatique APACHE	-	-	-	00990000	5	-	00290000	-	-	-	-	5	-

Verrou de sûreté / CAPITAL RESIST

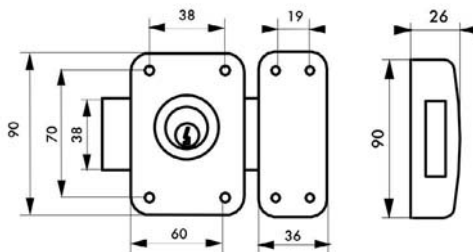

GARANTIE

Description/Description/Descripción

Coffre acier embouti. Gâche acier embouti. Pêne acier chromé mat. 3 clés

Pressed steel case, striker. Chrome plated steel bolt. 3 keys

Caja de acero embutido. Gacheta de acero embutido.

Pestillo de acero cromado mate. 3 llaves

Finition/Finish/Acabado

Epoxy or

Golden epoxy

Epoxi dorado

Version/Option/Versión

Double cylindre. Sans cylindre à bouton.

Boitier avec pêne alliage nickelé pour cylindre profilé.

Double cylinder. Without cylinder with knob.

For profile cylinder.

Doble cilindro. Sin cilindro de botón. Caja para cilindro perfilado.

Utilisation/Use/Utilización

Porte d'intérieur

Inside door

Puerta interior

Designation	Boite	Colis.	Prix	Sachet	Colis.	Prix	Brochable					Colis.	Prix
							France	Euro 1	Euro 2	Euro 3	Euro 4		
Verrou CAPITAL sans cylindre extérieur époxy or 3 clés	00092300	1	-	-	-	-	-	-	-	-	-	-	-

Ⓜ Non stocké/Non-stored/Producto no estocado - Ⓜ Sur stock Europe Zone 1 et Zone 2, nous consulter pour délai d'approvisionnement - Ⓜ Epuisement/Stock depletion/Agotamiento del stock

Verrou / AUTOMATIQUE WC

ECO

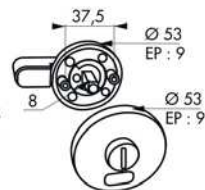

GARANTIE

Description/Description/Descripción

Nylon. Avec voyant libre/occupé.

Nylon. With indication bolt vacant/engaged

Nylon. Con indicador libre/ocupado

Finition/Finish/Acabado

Noir

Black

Negro

Utilisation/Use/Utilización

Pour salle de bains et WC

Bathroom and WC

Para cuartode baño y WC

Designation	Boite	Colis.	Prix	Sachet	Colis.	Prix	Brochable					Colis.	Prix
							France	Euro 1	Euro 2	Euro 3	Euro 4		
Verrou Ø 50 mm noir pour WC	-	-	-	00903039	10	-	00209039	00293039	00292039	-	-	10	-

Verrou / ALOUETTE WC

ECO

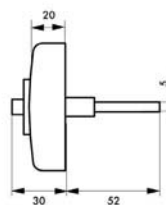
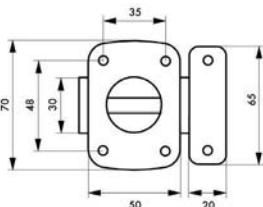

GARANTIE

Description/Description/Descripción

Coffre alliage moulé. Gâche alliage moulé. Bouton ABS

chromé. Pêne alliage moulé. Avec voyant libre / occupé.

Moulded alloy case. Moulded alloy striker. Chrome plated

ABS knob. Moulded alloy bolt. With indication bolt vacant

/ engaged.

Caja de aleación moldeada. Cerradero de aleación mol-

deada. Botón ABS cromado. Pestillo de aleación moldeada.

Con indicador luminoso libre / ocupado.

Finition/Finish/Acabado

Epoxy bronze

Bronze epoxy

Epoxi bronze

Utilisation/Use/Utilización

Pour salle de bains et WC

Bathroom and WC

Para cuartode baño y WC

Designation	Boite	Colis.	Prix	Sachet	Colis.	Prix	Brochable					Colis.	Prix
							France	Euro 1	Euro 2	Euro 3	Euro 4		
ALOUETTE 50 mm epoxy bronze pour WC	-	-	-	00900954	10	-	00200954	00293954	-	-	-	5	-
ALOUETTE 50 mm epoxy argent pour WC	-	-	-	00901955	10	-	-	-	-	-	-	-	-
Clé pour verrou Alouette 50 mm	-	-	-	00999954	10	-	-	-	-	-	-	-	-

⚠ Non stocké/Non-stored/Producto no estocado - 📦 Sur stock Europe Zone 1 et Zone 2, nous consulter pour délai d'approvisionnement - 📦 Epuisement/Stock depletion/Agotamiento del stock

Verrou / AUTOMATIQUE WC PROTECT

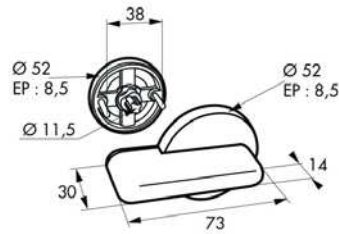

GARANTIE

Description/Description/Descripción

Coffre en alliage moulé. Avec voyant libre/occupé. Pour porte épaisseur 12 à 20mm maxi.
Moulded alloy body. With indication bolt vacant/engaged. Door thickness 12 to 20mm maxi.
 Caja de aleación moldeada. Con indicador libre/ocupado. Puertas de un espesor de 12 a 20mm maxi.

Finition/Finish/Acabado

Nickel satin
Nickel satin
 Niquel satinado

Utilisation/Use/Utilización

Pour salle de bains et WC
Bathroom and WC
 Para cuartode baño y WC

Designation	Boite	Colis.	Prix	Sachet	Colis.	Prix	Brochable					Colis.	Prix
							France	Euro 1	Euro 2	Euro 3	Euro 4		
Verrou Ø 50 mm nickelé satiné pour WC	00009037	10	-	00909037	5	-	00209037	00293137	00292137	-	-	10	-



Verrou / AUTOMATIQUE WC RESIST

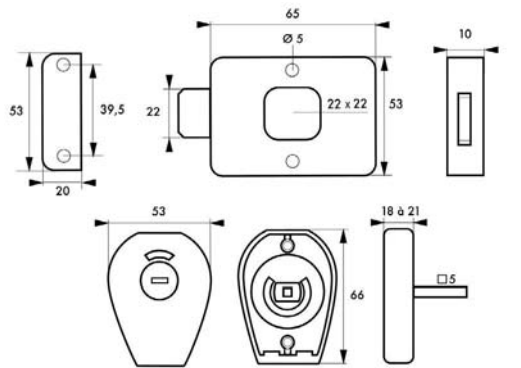

GARANTIE

Description/Description/Descripción

Coffre en alliage moulé. Avec voyant libre/occupé.
Moulded alloy body. With indication bolt vacant/engaged.
 Caja de aleación moldeada. Con indicador libre/ocupado.

Finition/Finish/Acabado

Argent
Silver
 Plata

Utilisation/Use/Utilización

Pour salle de bains et WC
Bathroom and WC
 Para cuartode baño y WC

Designation	Boite	Colis.	Prix	Sachet	Colis.	Prix	Brochable					Colis.	Prix
							France	Euro 1	Euro 2	Euro 3	Euro 4		
Verrou 65 mm pour WC	00009038	10	-	00909038	5	-	00209038	00293890	00292890	00294890	-	10	-

NS Non stocké/Non-stored/Producto no estocado - S Sur stock Europe Zone 1 et Zone 2, nous consulter pour délai d'approvisionnement - E Epuisement/Stock depletion/Agotamiento del stock

Verrou / AUTOMATIQUE WC RESIST



GARANTIE

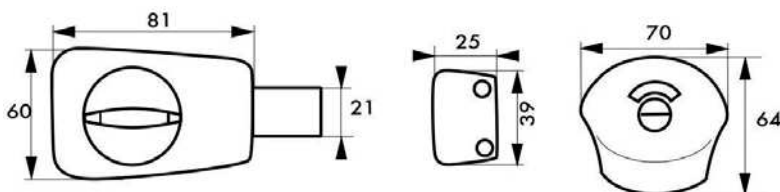

Description/Description/Descripción

Coffre inox moulé. Gâche inox moulé. Bouton inox moulé. Pêne inox. Avec voyant libre / occupé.

Moulded stainless steel case. Moulded stainless steel striker. Moulded stainless steel knob. Stainless steel bolt. With indication bolt vacant / engaged.

Caja de acero inoxidable moldeada. Cerradero de acero inoxidable moldeada. Botón de acero inoxidable. Pestillo de acero inoxidable. Con indicador luminoso. libre / ocupado.

Finition/Finish/Acabado

Inox brossé

Brushed stainless steel

Acero inoxidable

Utilisation/Use/Utilización

Pour salle de bains et WC

Bathroom and WC

Para cuartode baño y WC

Designation	Boite	Colis.	Prix	Sachet	Colis.	Prix	Brochable					Colis.	Prix
							France	Euro 1	Euro 2	Euro 3	Euro 4		
Verrou inox pour WC pour porte de 40 mm	-	-	-	00909035	5	-	00209035	00293968	00992035	00294968	-	10	-

NS Non stocké/Non-stored/Producto no estocado - S Sur stock Europe Zone 1 et Zone 2, nous consulter pour délai d'approvisionnement - E Epuisement/Stock depletion/Agotamiento del stock

Verrou de sûreté / ETENDARD ECO



NIVEAU DE SÉCURITÉ



GARANTIE



X 3

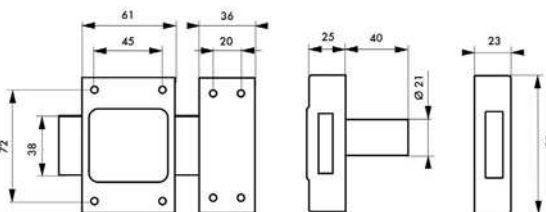

Description/Description/Descripción

Coffre acier cambré. Gâche acier cambré. Pêne acier chromé. Cylindre laiton à 4 goupilles. Entrée acier zingué. 3 clés en acier nickelé.

Cambered steel case. Cambered steel striker. Chrome plated steel bolt. 4 pin brass cylinder. Zinc steel key hole plate. 3 nickel plated steel keys.

Caja de acero curvado. Cerradero de acero curvado. Pestillo de acero cromado. Cilindro de latón con 4 pasadores. Entrada de acero cincado. 3 llaves de acero niquelado.

Finition/Finish/Acabado

Epoxy bronze

Bronze epoxy

Epoxi bronce

Utilisation/Use/Utilización

Pour porte de cave

Cellar door

Puerta de bodega

Designation	Boite	Colis.	Prix	Sachet	Colis.	Prix	Brochable				Colis.	Prix	
							France	Euro 1	Euro 2	Euro 3			Euro 4
ETENDARD sans bouton cylindre 40mm époxy bronze 3 clés	00001028	1	-	00901028	5	-	00301028	-	-	00294969	-	5	-

Verrou de sûreté / CORVETTE PROTECT



NIVEAU DE SÉCURITÉ



GARANTIE



X 3

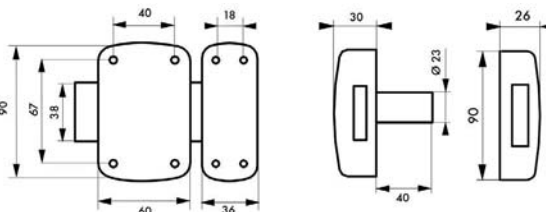

Description/Description/Descripción

Coffre et gâche acier embouti. Pêne acier nickelé. Cylindre laiton à 5 goupilles. Entrée laiton. 3 clés en acier nickelé.

Pressed steel case. Pressed steel striker. Nickel plated steel bolt. 5 pin brass cylinder. Brass key hole plate. 3 nickel plated steel keys.

Caja de acero embutido. Cerradero de acero embutido. Pestillo de acero niquelado. Cilindro de latón con 5 pasadores. Entrada latón. 3 llaves de acero niquelado.

Finition/Finish/Acabado

Epoxy bronze / *Bronze epoxy* / Epoxi bronce

Versión/Option/Versión

A bouton. A double cylindre. Sans cylindre à bouton.

Pour porte à recouvrement. Pour huisserie métallique. A système d'entrebaillage. Avec pêne 160 mm cylindre 30 mm pour porte de garage. *With knob. Double cylinder. Without cylinder with knob. For covering door frame. For steel door frame, guard system. With 160 mm bolt and 30 mm length. cylinder for garage door.*

Con botón. Doble cilindro. Sin cilindro de botón. Para puerta que recubre el marco. Para marco metálico. Patilla de retención. Con pestillo 160 mm cilindro 30 mm para puerta de garaje.

Utilisation/Use/Utilización

Pour porte de cave / *Cellar door* / Puerta de bodega

Designation	Boite	Colis.	Prix	Sachet	Colis.	Prix	Brochable				Colis.	Prix	
							France	Euro 1	Euro 2	Euro 3			Euro 4
CORVETTE sans bouton cylindre 40 mm époxy bronze 3 clés	00002910	1	-	-	-	-	00302910	-	-	-	-	5	-

Verrou / CAPITAL RESIST



NIVEAU DE SÉCURITÉ



GARANTIE



X 3



Foncet vissé
démontable

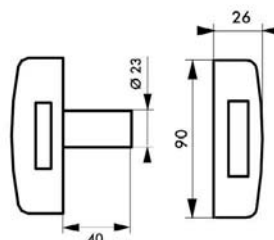
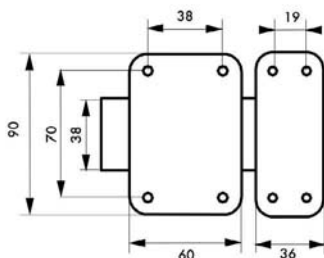

Description/Description/Descripción

Coffre et gâche acier embouté. Pêne acier chromé mat. Cylindre laiton à 5 goupilles type HG5. Protection contre l'arrachement du cylindre par pilier et cavalier. Pêne interchangeable. Entrée laiton - 3 clés en acier nickelé.

Pressed steel case. Pressed steel striker. Dull chrome plated steel bolt. 5 pin brass cylinder. Safety device against drawing the cylinder by rider and pillar. Brass key hole plate. 3 nickel plated steel keys.

Caja de acero embutido. Cerradero de acero embutido. Pestillo de acero cromado mate. Cilindro de latón con 5 pasadores. Protección contra el arrancamiento del cilindro mediante pilar y caballete. Entrada de latón. w3 llaves de acero niquelado.

Finition/Finish/Acabado

Epoxy or
Gold epoxy
Epoxi dorado

Version/Option/Versión

Double cylindre. Avec pêne 160 mm cylindre 30 mm pour porte de garage. Pour cylindre profilé. Avec pêne alliage nickelé. Autres longueurs de cylindre sur demande.

Double cylinder. With 160 mm bolt and 30 mm length cylinder for garage door. For profile cylinder.

Doble cilindro. Con pestillo 160 mm cilindro 30 mm para puerta de garaje. Para cilindro perfilado.

Utilisation/Use/Utilización

Pour porte de cave
Cellar door
Puerta de bodega

Designation	Boite	Colis.	Prix	Sachet	Colis.	Prix	Brochable					Colis.	Prix
							France	Euro 1	Euro 2	Euro 3	Euro 4		
CAPITAL sans bouton cylindre 40 mm epoxy or 3 clés	00091309	1	-	-	-	-	-	-	-	-	-	-	-
Tarif conditionnement non décollable													
CAPITAL sans bouton cylindre 40 mm epoxy or 3 clés - carton 25 pièces	00091314	1	-	-	-	-	-	-	-	-	-	-	-

⚠ Non stocké/Non-stored/Producto no estocado - 📦 Sur stock Europe Zone 1 et Zone 2, nous consulter pour délai d'approvisionnement - 📦 Epuisement/Stock depletion/Agotamiento del stock

Verrou de sûreté / CORVETTE

PROTECT



NIVEAU DE SÉCURITÉ



GARANTIE



X 3

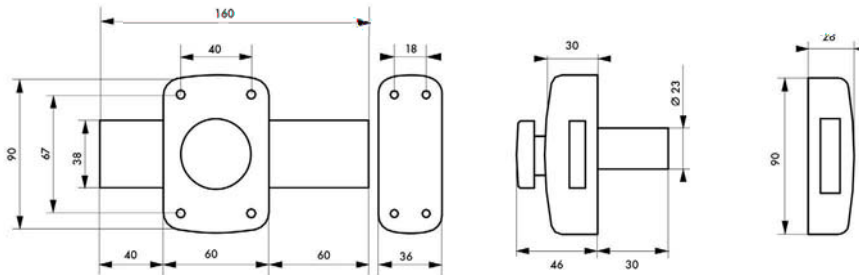

Description/Description/Descripción

Coffre et gâche acier embouti. Pêne acier nickelé. Bouton ABS chromé. Cylindre laiton à 5 goupilles. Entrée laiton. 3 clés en acier nickelé.

Pressed steel case. Pressed steel striker. Nickel plated steel bolt. Chrome plated ABS knob. 5 pin brass cylinder. Brass key hole plate. 3 nickel plated steel keys.

Caja de acero embutido. Cerradero de acero embutido. Pestillo de acero niquelado. Botón de ABS cromado. Cilindro de latón con 5 pasadores. Entrada latón. 3 llaves de acero niquelado.

Finition/Finish/Acabado

Epoxy bronze
Bronze epoxy
Epoxi bronce

Version/Option/Versión

A bouton. A double cylindre. Sans cylindre à bouton. Sans bouton. Pour porte à recouvrement. Pour huisserie métallique. A système d'entrebaillage.

With knob. Double cylinder. Without cylinder with knob. Without knob. For covering door frame. For steel door frame, guard system. Without outside cylinder.

Con botón. Doble cilindro. Sin cilindro de botón. Sin botón. Para puerta que recubre el marco. Para marco metálico. Patilla de retención. Sin cilindro exterior.

Utilisation/Use/Utilización

Pour porte de garage
Garage door
Puerta de garaje

Designation	Boite	Colis.	Prix	Sachet	Colis.	Prix	Brochable					Colis.	Prix
							France	Euro 1	Euro 2	Euro 3	Euro 4		
CORVETTE à bouton et cyl. 30 mm pêne 160mm 3 clés	00003014	1	-	00903014	5	-	00503014	00593977 NS	00592977 NS	-	-	5	-
CORVETTE à cylindre double 30 mm pêne 160mm 3 clés	00003024	1	-	-	-	-	00503024	00593978 NS	00592978 NS	-	-	5	-

NS Non stocké/Non-stored/Producto no estocado - Sur stock Europe Zone 1 et Zone 2, nous consulter pour délai d'approvisionnement - E Epuisement/Stock depletion/Agotamiento del stock

Verrou de sûreté / APACHE

RESIST



NIVEAU DE SÉCURITÉ



GARANTIE



X 3

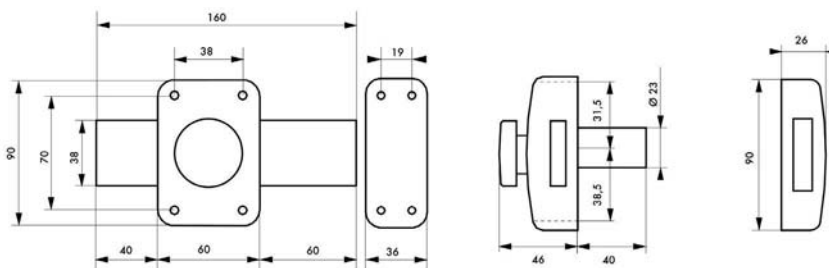

Description/Description/Descripción

Coffre et gâche acier embouté. Pêne acier chromé. Bouton ABS mat. Cylindre laiton à 5 goupilles. Pêne interchangeable. Entrée laiton - 3 clés en acier nickelé.

Pressed steel case. Pressed steel striker. Dull ABS knob. Chrome plated steel bolt. 5 pin brass cylinder. Brass key hole plate. 3 nickel plated steel keys.

Caja de acero embutido. Cerradero de acero embutido. Pestillo de acero cromado. Botón de ABS mate. Cilindro de latón con 5 pasadores. Entrada de latón. 3 llaves de acero niquelado.

Finition/Finish/Acabado

Epoxy or
Gold epoxy
Epoxi dorado

Versión/Option/Versión

A bouton. Double cylindre. Sans cylindre extérieur, sans bouton. Pour cylindre profilé. Pêne 140 mm pour porte à recouvrement

With knob. Double cylinder. Without knob. Without outside cylinder. Bolt 140 mm for covering door frame.

Con botón. Doble cilindro. Sin botón. Sin cilindro exterior. Pestillo 140 mm para puerta que recubre el marco.

Utilisation/Use/Utilización

Pour porte de garage

Garage door

Puerta de garaje

Designation	Boite	Colis.	Prix	Sachet	Colis.	Prix	Brochable					Colis.	Prix
							France	Euro 1	Euro 2	Euro 3	Euro 4		
APACHE à bouton et cyl. 40 mm pêne 160mm 3 clés	-	-	-	00991501	5	-	00490501	-	-	-	-	5	-
APACHE à bouton et cyl. 45 mm pêne 140mm pour porte à recouvrement 3 clés	-	-	-	-	-	-	00490511	-	-	-	-	5	-

⚠ Non stocké/Non-stored/Producto no estocado - 📦 Sur stock Europe Zone 1 et Zone 2, nous consulter pour délai d'approvisionnement - 📦 Epuisement/Stock depletion/Agotamiento del stock

Verrou de sûreté / CAPITAL RESIST



NIVEAU DE SÉCURITÉ



GARANTIE



X 3



Foncet vissé
démontable

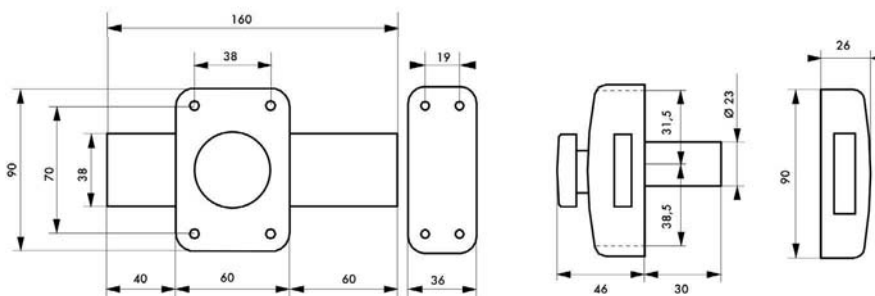

Description/Description/Descripción

Coffre et gâche acier embouté. Pêne acier chromé mat. Bouton ABS chromé mat. Cylindre laiton à 5 goupilles type HG5. Pêne interchangeable. Entrée laiton - 3 clés en acier nickelé.

Pressed steel case. Pressed steel striker. Dull chrome plated ABS knob. Dull chrome plated steel bolt. 5 pin brass cylinder. Brass key hole plate. 3 nickel plated steel keys.

Caja de acero embutido. Cerradero de acero embutido. Pestillo de acero cromado mate. Botón de ABS cromado mate. Cilindro de latón con 5 pasadores. Entrada de latón. 3 llaves de acero niquelado.

Finition/Finish/Acabado

Epoxy or
Gold epoxy
Epoxi dorado

Version/Option/Versión

A bouton. Double cylindre. Sans cylindre extérieur, sans bouton. Pour cylindre profilé. Avec pêne alliage nickelé. Autres longueurs de cylindre sur demande.

With knob. Double cylinder. Without knob. Without outside cylinder.

Con botón. Doble cilindro. Sin botón. Sin cilindro exterior.

Utilisation/Use/Utilización

Con botón. Doble cilindro. Sin botón. Sin cilindro exterior.
Garage door
Puerta de garaje

Designation	Boite	Colis.	Prix	Sachet	Colis.	Prix	Brochable				Colis.	Prix
							France	Euro 1	Euro 2	Euro 3		
CAPITAL à bouton et cylindre 30 mm pêne 160mm 3 clés	00091316	1	-	-	-	-	-	-	-	-	-	-
CAPITAL à cylindre double 30 mm pêne 160mm 3 clés	00092316	1	-	-	-	-	-	-	-	-	-	-

Non stocké/Non-stored/Producto no estocado - Sur stock Europe Zone 1 et Zone 2, nous consulter pour délai d'approvisionnement - Epuisement/Stock depletion/Agotamiento del stock

Verrou / TRANSVERSAL ECO



GARANTIE

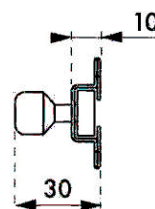
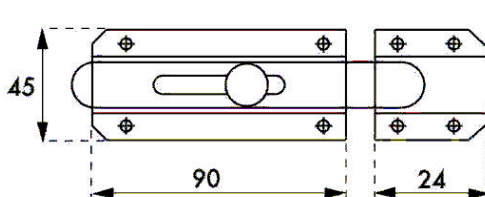
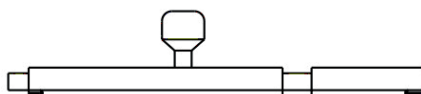

Description/Description/Descripción

Corps acier. Pêne plat coulissant. Bouton rond
Steel case. Sliding flat bolt. Round knob.
Cuerpo de acero. Pestillo plano deslizante. Botón redondo.

Finition/Finish/Acabado

Laqué marron
Brown lacquered
Marrón lacado

Utilisation/Use/Utilización

Pour portail, barrières
For gates, barriers
Para puertas, barreras

Designation	Boite	Colis.	Prix	Sachet	Colis.	Prix	Brochable					Colis.	Prix
							France	Euro 1	Euro 2	Euro 3	Euro 4		
Petit verrou transversal peint 90mm	-	-	-	00912251	1	-	-	-	-	-	-	-	-

⚠ Non stocké/Non-stored/Producto no estocado - 📦 Sur stock Europe Zone 1 et Zone 2, nous consulter pour délai d'approvisionnement - 📦 Epuisement/Stock depletion/Agotamiento del stock

Verrou / PÊNE ROND ECO



GARANTIE

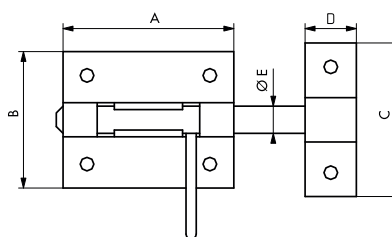

	8mm	10mm	12mm	14mm	16mm
A	55	70	80	90	100
B	38	47	53	55	72
C	40	51	52	56	68
D	15	16	15	20	25
ØE	8	10	12	14	16

Description/Description/Descripción

Platine acier cambré. Gâche acier cambré. Bouton poire.
Pêne rond coulissant.
Cambered steel plate. Cambered steel striker. Oval knob.
Sliding round bolt.
pletina de acero curvado. Cerradero de acero curvado.
Botón pera. pestillo redondo deslizante.

Finition/Finish/Acabado

Zingué
Zinc coated
Cincado

Designation	Boite	Colis.	Prix	Sachet	Colis.	Prix	Brochable					Colis.	Prix
							France	Euro 1	Euro 2	Euro 3	Euro 4		
Verrou de box pêne Ø 8 mm	-	-	-	00906040	25	-	00206040	-	-	-	-	10	-
Verrou de box pêne Ø 10 mm	-	-	-	00906060	25	-	00206060	00293106 NS	00292106 NS	00294106	-	10	-
Verrou de box pêne Ø 12 mm	-	-	-	00906080	25	-	00206080	00293107 NS	00292107 NS	00294107	-	10	-
Verrou de box pêne Ø 14 mm	-	-	-	00906090	25	-	00206090	00293108 NS	00292108 NS	00294108	-	10	-
Verrou de box pêne Ø 16 mm	-	-	-	00906110	25	-	-	-	-	-	-	-	-

NS Non stocké/Non-stored/Producto no estocado - Sur stock Europe Zone 1 et Zone 2, nous consulter pour délai d'approvisionnement - E Epuisement/Stock depletion/Agotamiento del stock

Targette / A PORTE CADENAS PROTECT



GARANTIE

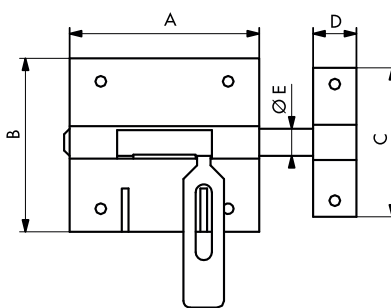

	10mm	12mm	14mm	16mm
A	70	80	90	100
B	62	67,5	76	75
C	50	48	60	57
D	16	20	25	30
ØE	9,45	11,45	13,5	15,5

Description/Description/Descripción

Platine acier cambré. Gâche acier cambré. Patte porte-cadenas. Pêne rond coulissant.

Cambered steel plate. Cambered steel striker. Padlock staple. Sliding round bolt.

Pletina de acero curvado. Cerradero de acero curvado. Patilla portacandado. Pestillo redondo destizante.

Finition/Finish/Acabado

Bronze

Bronze

Bronce

Designation	Boite	Colis.	Prix	Sachet	Colis.	Prix	Brochable					Colis.	Prix
							France	Euro 1	Euro 2	Euro 3	Euro 4		
Verrou de box pêne Ø 10 mm cadenassable	-	-	-	00907060	25	-	00207060	00293131 NS	00292131 NS	00294131	-	10	-
Verrou de box pêne Ø 12 mm cadenassable	-	-	-	00907080	25	-	00207080	00293132 NS	00292132 NS	00294132	-	10	-
Verrou de box pêne Ø 14 mm cadenassable	-	-	-	00907090	25	-	00207090	00293133 NS	00292133 NS	00294133	-	10	-
Verrou de box pêne Ø 16 mm cadenassable	-	-	-	00907110	25	-	-	-	-	-	-	-	-

NS Non stocké/Non-stored/Producto no estocado - S Sur stock Europe Zone 1 et Zone 2, nous consulter pour délai d'approvisionnement - E Epuisement/Stock depletion/Agotamiento del stock

Verrou / A RESSORT PROTECT

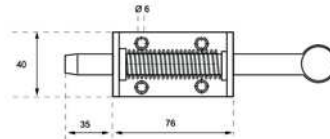
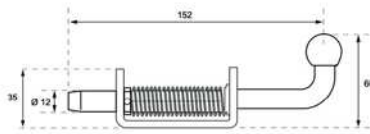

GARANTIE

Description/Description/Descripción

Corps acier zingué. Pêne rond coulissant acier zingué.
Livré sans gâche.

Galvanized steel body. Round sliding bolt, galvanized steel.
Delivered without striker.

Cuerpo de acero galvanizado. Pestillo redondo deslizante,
acero galvanizado. Se entrega sin placa de cierre.

Finition/Finish/Acabado

Zingué.
Zinc plated.

Cincado.

Utilisation/Use/Utilización

Inérieur-Extérieur. Pour portes, portails, porte sectionnelle, remorques.
Indoor/outdoor. For doors, gates, sectional doors, trailers.
Interior/exterior. Para puertas, portones, puertas seccionales, remolques.

Designation	Boite	Colis.	Prix	Sachet	Colis.	Prix	Brochable					Colis.	Prix
							France	Euro 1	Euro 2	Euro 3	Euro 4		
Verrou à ressort L.150mm	-	-	-	00912203	1	-	-	-	-	-	-	-	-

Targette / CADENASSABLE PROTECT

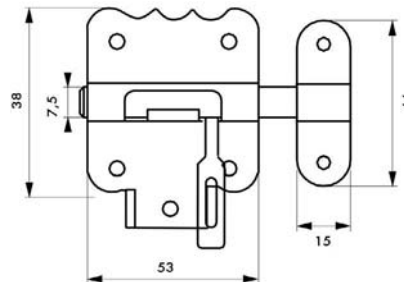

GARANTIE

Description/Description/Descripción

Platine acier cambré. Gâche acier cambré. Patte porte-cadenas.

Cambered steel plate. Cambered steel striker. Padlock staple.

Sliding round bolt. Pletina de acero curvado. Cerradero de acero curvado.
Patilla portacandado. Pestillo redondo deslizante.

Finition/Finish/Acabado

Bronze

Bronze

Bronce

Designation	Boite	Colis.	Prix	Sachet	Colis.	Prix	Brochable					Colis.	Prix
							France	Euro 1	Euro 2	Euro 3	Euro 4		
Targette cadenasable	-	-	-	00909033	10	-	00109033	00193322 NSI	00192322 NSI	00194322	-	10	-

NSI Non stocké/Non-stored/Producto no estocado - Sur stock Europe Zone 1 et Zone 2, nous consulter pour délai d'approvisionnement - E Epuement/Stock depletion/Agotamiento del stock



GARANTIE

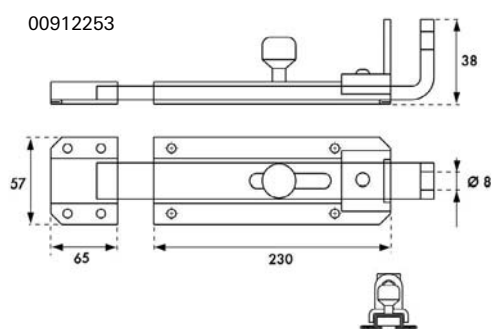
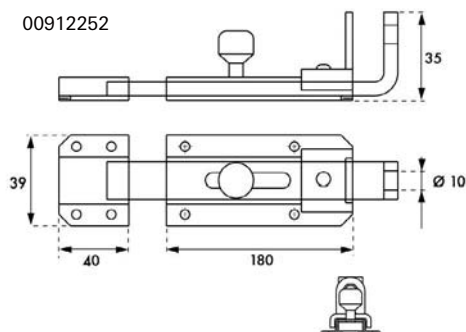

Description/Description/Descripción

Corps acier cambré. Pêne plat coulissant. Gâche acier cambré. Bouton rond. Patte porte-cadenas.
Cambered steel case. Sliding flat bolt. Cambered steel striker. Round knob. Padlock holder.
Cuerpo de acero. Pestillo plano deslizante. Cerradero de acero. Botón redondo. Soporte para candado..

Finition/Finish/Acabado

Zingué.
Zinc plated.
Cincado.

Version/Option/Versión

Léger 180mm / Lourd 230mm .
Light 180mm / Heavy 230mm.
Ligero 180mm / Pesado 230mm.

Utilisation/Use/Utilización

Pour portail, barrières
For gates, barriers
Para puertas, barreras

Designation	Boite	Colis.	Prix	Sachet	Colis.	Prix	Brochable					Colis.	Prix
							France	Euro 1	Euro 2	Euro 3	Euro 4		
Verrou transversal porte-cadenas léger 180 mm	-	-	-	00912252	1	-	-	-	-	-	-	-	-
Verrou transversal porte-cadenas lourd 230 mm	-	-	-	00912253	1	-	-	-	-	-	-	-	-

Verrou / PORTE-CADENAS PROTECT



GARANTIE



00912254

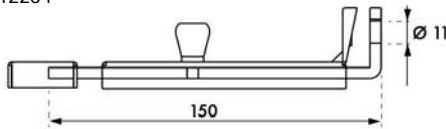

00912255

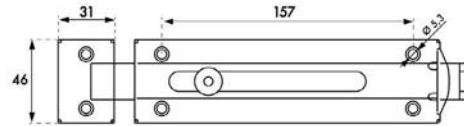
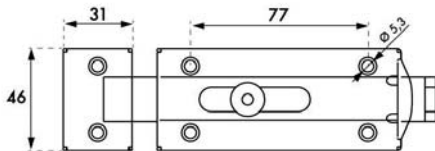
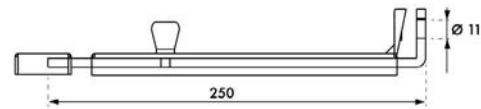

Description/Description/Descripción

Corps acier cambré. Pêne plat coulissant. Gâche acier cambré. Bouton rond. Patte porte-cadenas.

Cambered steel case. Sliding flat bolt. Cambered steel striker. Round knob. Padlock holder.

Cuerpo de acero. Pestillo plano deslizante. Cerradero de acero. Botón redondo. Soporte para candado..

Finition/Finish/Acabado

Zingué.

Zinc plated.

Cincado.

Utilisation/Use/Utilización

Pour portail, barrières

For gates, barriers

Para puertas, barreras

Designation	Boite	Colis.	Prix	Sachet	Colis.	Prix	Brochable					Colis.	Prix
							France	Euro 1	Euro 2	Euro 3	Euro 4		
Verrou porte-cadenas zingué 150mm	-	-	-	00912254	1	-	-	-	-	-	-	-	-
Verrou porte-cadenas zingué 250mm	-	-	-	00912255	1	-	-	-	-	-	-	-	-

⊗ Non stocké/Non-stored/Producto no estocado - ⊠ Sur stock Europe Zone 1 et Zone 2, nous consulter pour délai d'approvisionnement - ⊞ Epuisement/Stock depletion/Agotamiento del stock

Verrou / COULISSANT CADENASSABLE RESIST

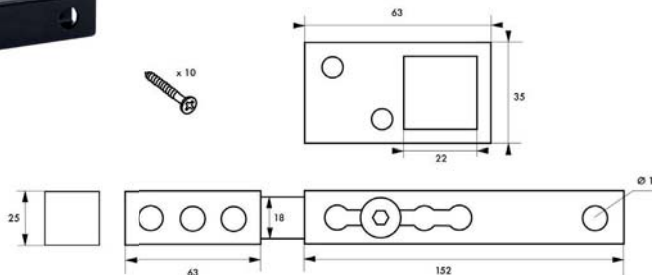

GARANTIE

Description/Description/Descripción

Acier cémenté. Recouvrement des vis en position fermée. Système de verrouillage à pêne coulissant.
Hardened steel. Screws covered in closed condition.
Sliding bolt.

Acero cementado. Recubrimiento de los tornillos en posición cerrada. Pestillo deslizante.

Finition/Finish/Acabado

Noir

Black

Negro

Utilisation/Use/Utilización

Protection renforcée pour portes, portails

Heavy duty security for doors and gates.

Protección reforzada para puertas y portales

Designation	Boite	Colis.	Prix	Sachet	Colis.	Prix	Brochable					Colis.	Prix
							France	Euro 1	Euro 2	Euro 3	Euro 4		
Verrou coulissant cadenassable	00013929	1	-	-	-	-	-	-	-	-	-	-	-

Targette / A COMBINAISON PROTECT

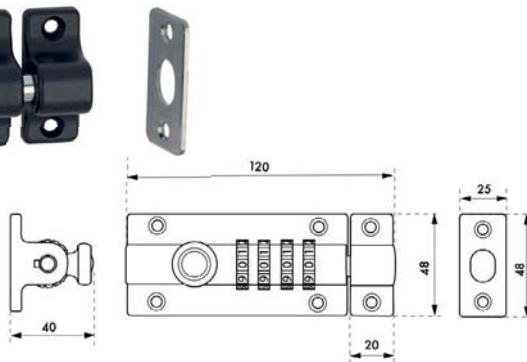

GARANTIE



CODE MODIFIABLE

Description/Description/Descripción

Corps zinc moulé. Pêne rond coulissant acier. Mécanisme à combinaison modifiable de 4 chiffres - 10000 combinaisons différentes. Fourni avec gâche en applique et à encastrer.

Cast zinc body. Round sliding steel bolt. 4-digit changeable combination mechanism - 10000 different combinations. Supplied with surface and mortise strike.

Cuerpo de zinc fundido. Pestillo deslizante de acero redondo. Mecanismo de combinación modificable de 4 dígitos: 10000 combinaciones diferentes. Se suministra con cerradura de empotrar y de superficie.

Finition/Finish/Acabado

Résistant à la corrosion.

Corrosion-resistant.

Resistente a la corrosión.

Utilisation/Use/Utilización

Inérieur-Extérieur. Accès multi-utilisateurs. Pour porte, portails, armoires, locaux industriels

Indoor-outdoor. Multi-user access. For doors, gates, cabinets, industrial areas.

Interior-exterior. Acceso multiusuario. Para puertas, portones, armarios, instalaciones industriales.

Designation	Boite	Colis.	Prix	Sachet	Colis.	Prix	Brochable					Colis.	Prix
							France	Euro 1	Euro 2	Euro 3	Euro 4		
Targette à combinaison 4 viroles	00013829	1	-	-	-	-	00413829	-	-	-	-	1	-

⚠ Non stocké/Non-stored/Producto no estocado - 📦 Sur stock Europe Zone 1 et Zone 2, nous consulter pour délai d'approvisionnement - 📦 Epuisement/Stock depletion/Agotamiento del stock

Verrou / MIRAGE RESIST



NIVEAU DE SÉCURITÉ



GARANTIE



X 3

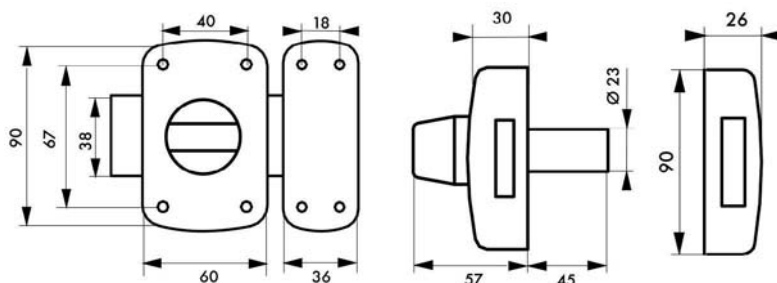

Description/Description/Descripción

Coffre en laiton embouti. Gâche laiton embouti. Pêne en laiton. Cylindre laiton à 5 goupilles. Protection contre l'arrachement du cylindre par pilier et cavalier. Entrée laiton. 3 clés en acier nickelé.

Pressed brass case. Pressed brass striker. Brass bolt. 5 pin brass cylinder. Safety device against drawing the cylinder by rider and pillar. Brass key hole plate. 3 nickel plated steel keys.

Caja de latón embutido. Cerradero de latón embutido. Pestillo de latón. Cilindro de latón con 5 pasadores. Protección contra el arrancamiento del cilindro por pilar y caballete. Entrada de latón. 3 llaves de acero niquelado

Finition/Finish/Acabado

Laiton.

Brass.

Latón.

Designation	Boîte	Colis.	Prix	Sachet	Colis.	Prix	Brochable					Colis.	Prix
							France	Euro 1	Euro 2	Euro 3	Euro 4		
Mirage à cylindre double 45 mm	00003022	1	-	-	-	-	00303022	-	-	-	-	5	-

Non stocké/Non-stored/Producto no estocado - Sur stock Europe Zone 1 et Zone 2, nous consulter pour délai d'approvisionnement - Epuement/Stock depletion/Agotamiento del stock

Targette / PÊNE ROND ECO



GARANTIE

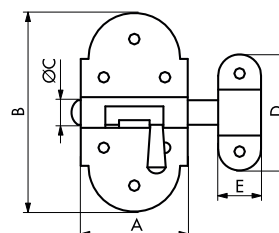

	25 mm	35 mm	40 mm
A	25	35	40
B	50	65	75
ØC	7	8	9
D	38	38	54
E	12	14	16

Description/Description/Descripción

Platine acier embouti. Gâche acier embouti. Bouton poire. Pêne rond coulissant.

Pressed steel plate. Pressed steel striker. Oval knob. Sliding round bolt.

Pletina de acero embutido. Cerradero de acero embutido. Botón pera. Pestillo redondo deslizante.

Finition/Finish/Acabado

Zingué. Nickelé.

Zinc coated. Nickel plated.

Cincado. Niquelado

Designation	Boite	Colis.	Prix	Sachet	Colis.	Prix	Brochable					Colis.	Prix
							France	Euro 1	Euro 2	Euro 3	Euro 4		
Targette nickelée 25 mm	-	-	-	00900627	10	-	00100627	00193100 NS	00192100 NS	00194100	-	10	-
Targette nickelée 35 mm	-	-	-	00900635	10	-	00100635	00193101 NS	00992101 NS	00194101	-	10	-
Targette nickelée 40 mm	-	-	-	00900640	10	-	00100640	00193102 NS	00192102 NS	00194102	-	10	-
Targette zinguée 25 mm	-	-	-	-	-	-	00101627	00193103 NS	00192103 NS	00194103	-	10	-
Targette zinguée 35 mm	-	-	-	-	-	-	00101635	00193104 NS	00192104 NS	00194104	-	10	-
Targette zinguée 40 mm	-	-	-	-	-	-	00101640	00193105 NS	00192105 NS	00194105	-	10	-

NS Non stocké/Non-stored/Producto no estocado - ☑ Sur stock Europe Zone 1 et Zone 2, nous consulter pour délai d'approvisionnement - ☒ Epuisement/Stock depletion/Agotamiento del stock

Targette / PÊNE PLAT ECO

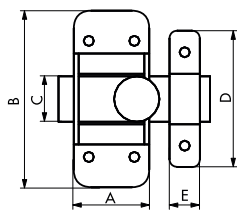

	30 mm	40 mm
A	30	40
B	70	80
C	18	21
D	54	68
E	12	15



GARANTIE

Description/Description/Descripción

Acier cémenté. Recouvrement des vis en position fermée. Système de verrouillage à pêne coulissant.

Hardened steel. Screws covered in closed condition. Sliding bolt.

Acero cementado. Recubrimiento de los tornillos en posición cerrada. Pestillo deslizante.

Finition/Finish/Acabado

Noir

Black

Negro

Utilisation/Use/Utilización

Protection renforcée pour portes, portails

Heavy duty security for doors and gates.

Protección reforzada para puertas y portales

Designation	Boite	Colis.	Prix	Sachet	Colis.	Prix	Brochable				Colis.	Prix	
							France	Euro 1	Euro 2	Euro 3			Euro 4
Targette zinguée pêne plat 30 mm	-	-	-	00900730	10	-	00100730	00193096 NS	00192096 NS	00194096	-	10	-
Targette zinguée pêne plat 40 mm	-	-	-	00900740	10	-	00100740	00193097 NS	00192097 NS	00194097	-	10	-

Targette / PÊNE ROND ECO

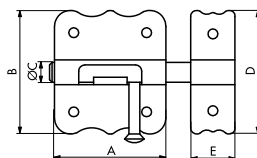
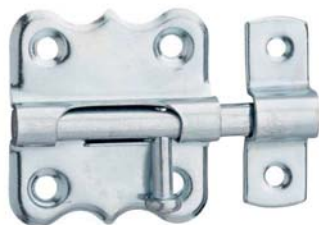

	35 mm	45 mm
A	38	49
B	41	48
C	6	6,5
D	36	48
E	16	16



GARANTIE

Description/Description/Descripción

Platine acier cambré. Gâche acier cambré. Bouton poire. Pêne rond coulissant.

Cambered steel plate. Cambered steel striker. Oval knob. Sliding round bolt.

Pletina de acero curvado. Cerradero de acero curvado. Botón pera. Pestillo redondo deslizante.

Finition/Finish/Acabado

Zingué

Zinc coated

Cincado

Designation	Boite	Colis.	Prix	Sachet	Colis.	Prix	Brochable				Colis.	Prix	
							France	Euro 1	Euro 2	Euro 3			Euro 4
Targette zinguée 35 mm	-	-	-	00902035	10	-	00102035	00193098 NS	00192098 NS	00194098	-	10	-
Targette zinguée 45 mm	-	-	-	00902045	10	-	00102045	00193099 NS	00192099 NS	00194099	-	10	-

NS Non stocké/Non-stored/Producto no estocado - S Sur stock Europe Zone 1 et Zone 2, nous consulter pour délai d'approvisionnement - E Epuisement/Stock depletion/Agotamiento del stock

Verrou automatique / PÊNE PLAT

PROTECT



GARANTIE

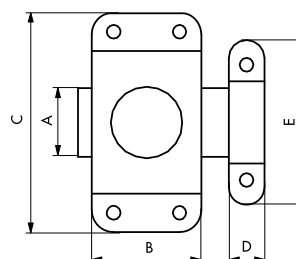

	25mm	30mm	35mm	40mm
A	16	19	22	25
B	25	30	35	40
C	60	70	75	80
D	10	12	12	13
E	45	53	55	60

Description/Description/Descripción

Coffre acier cambré. Gâche acier cambré. Bouton tournant. Pêne plat.

Cambered steel case. and striker. Turning knob. Flat bolt.

Caja de acero curvado. Cerradero de acero curvado.

Botón giratorio. Pestillo plano.

Finition/Finish/Acabado

Zingué. Nickelé.

Zinc coated. Nickel plated.

Cincado. Niquelado.

Designation	Boite	Colis.	Prix	Sachet	Colis.	Prix	Brochable					Colis.	Prix
							France	Euro 1	Euro 2	Euro 3	Euro 4		
Verrou 25 mm acier zingué	-	-	-	00900925	5	-	00100925	00193115 NS	00192115 NS	00194115	-	10	-
Verrou 30 mm acier zingué	-	-	-	00900930	5	-	00100930	00193116 NS	00192116 NS	00194116	-	10	-
Verrou 35 mm acier zingué	-	-	-	00900935	5	-	00100935	00193117 NS	00192117 NS	00194117	-	10	-
Verrou 40 mm acier zingué	-	-	-	00900940	5	-	00100940	00193118 NS	00192118 NS	00194118	-	10	-
Verrou 25 mm acier nickelé	-	-	-	00901925	5	-	00101925	00193111 NS	00192111 NS	00194111	-	10	-
Verrou 30 mm acier nickelé	-	-	-	00901930	5	-	00101930	00193112 NS	00192112 NS	00194112	-	10	-
Verrou 35 mm acier nickelé	-	-	-	00901935	5	-	00101935	00193113 NS	00192113 NS	00194113	-	10	-
Verrou 40 mm acier nickelé	-	-	-	00901940	5	-	00101940	00193114 NS	00192114 NS	00194114	-	10	-

NS Non stocké/Non-stored/Producto no estocado - ☐ Sur stock Europe Zone 1 et Zone 2, nous consulter pour délai d'approvisionnement - E Epuisement/Stock depletion/Agotamiento del stock

Verrou automatique / ALOUETTE

ECO



GARANTIE

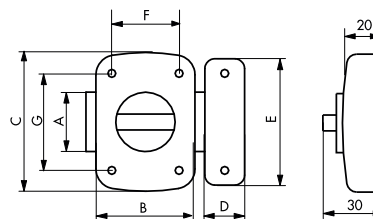

	30mm	40mm	50mm
A	20	25	30
B	30	40	50
C	42	55	70
D	15	18	20
E	40	52	65
F	18	28	35
G	30	40	48

Description/Description/Descripción

Coffre alliage moulé. Gâche alliage moulé. Bouton ABS chromé. Pêne alliage moulé (50 mm). Pêne acier nickelé (30 - 40 mm).

Moulded alloy case. Moulded alloy striker. Chrome plated ABS knob. Moulded alloy bolt (50 mm). Nickel plated steel bolt. (30 - 40 mm).

Caja de aleación moldeada. Cerradero de aleación moldeada. Botón ABS cromado. Pestillo de aleación moldeada (50 mm). Pestillo de acero niquelado (30 - 40 mm).

Finition/Finish/Acabado

Epoxy bronze

Bronze epoxy

Epoxi bronze

Versión/Option/Versión

Chromé brillant. Epoxy argent.

Chromé brillant. Epoxy argent.

Cromado brillante. Epoxy plata.

Designation	Boîte	Colis.	Prix	Sachet	Colis.	Prix	Brochable					Colis.	Prix
							France	Euro 1	Euro 2	Euro 3	Euro 4		
ALOUETTE 30 mm epoxy bronze	-	-	-	00900932	10	-	00100932	-	-	-	-	10	-
ALOUETTE 30 mm chromé brillant	-	-	-	00900933	10	-	00100933	-	-	-	-	10	-
ALOUETTE 30 mm epoxy argent	-	-	-	00901933	10	-	00101933	-	-	00194354	-	10	-
ALOUETTE 40 mm epoxy bronze	-	-	-	00900942	10	-	00100942	00193263 NS	00192263 NS	00194263	-	10	-
ALOUETTE 40 mm chromé brillant	-	-	-	00900943	10	-	00100943	00193264 NS	-	-	-	10	-
ALOUETTE 40 mm epoxy argent	-	-	-	00901943	10	-	00101943	00193265 NS	-	00194266	-	10	-
ALOUETTE 50 mm epoxy bronze	-	-	-	00900952	10	-	00100952	-	-	-	-	10	-
ALOUETTE 50 mm chromé brillant	-	-	-	00900953	10	-	00100953	-	-	-	-	10	-
ALOUETTE 50 mm epoxy argent	-	-	-	00901953	10	-	00101953	-	-	-	-	10	-

NS Non stocké/Non-stored/Producto no estocado - Sur stock Europe Zone 1 et Zone 2, nous consulter pour délai d'approvisionnement - E Epuisement/Stock depletion/Agotamiento del stock

Targette / PÊNE ROND

PROTECT



GARANTIE

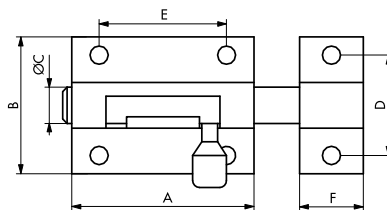

	30mm	35 mm	40mm	50mm	70mm
A	30	35	40	50	70
B	30	30	30	30	30
C	8	8	8	8	8
D	21	21	21	21	21
E	18	24	25	35	56
F	12	14	14	20	20

Description/Description/Descripción

Corps laiton étiré. Gâche laiton étiré. Bouton laiton décolleté. Pêne rond coulissant.

Drawn brass case. Drawn brass striker. Turned brass knob. Sliding round bolt.

Cuerpo de latón estirado. Cerradero de latón estirado. Botón de latón escotado. Pestillo redondo deslizante.

Finition/Finish/Acabado

Laiton poli. Chromé. Laqué blanc
Polished brass. Chrome plated. White lacquered
 Latón pulido. Cromado. Lacado blanco

Designation	Boite	Colis.	Prix	Sachet	Colis.	Prix	Brochable					Colis.	Prix
							France	Euro 1	Euro 2	Euro 3	Euro 4		
Targette laiton 30 mm	-	-	-	00900830	20	-	00100830	00193119 NS	00192119 NS	00194119	-	10	-
Targette laiton 35 mm	-	-	-	00900835	20	-	00100835	-	-	-	-	10	-
Targette laiton 40 mm	-	-	-	00900840	20	-	00100840	00193120 NS	00192120 NS	00194120	-	10	-
Targette laiton 50 mm	-	-	-	00900850	20	-	00100850	00193121 NS	00192121 NS	00194121	-	10	-
Targette laiton 70 mm	-	-	-	00900870	20	-	00100870	00193122 NS	00192122 NS	00194122	-	10	-
Targette laiton chromé 30 mm	-	-	-	00900831	20	-	00100831	00193127 NS	00192127 NS	00194127	-	10	-
Targette laiton chromé 35 mm	-	-	-	00900836	20	-	00100836	-	-	-	-	10	-
Targette laiton chromé 40 mm	-	-	-	00900841	20	-	00100841	00193128 NS	00192128 NS	00194128	-	10	-
Targette laiton chromé 50 mm	-	-	-	00900851	20	-	00100851	00193129 NS	00192129 NS	00194129	-	10	-
Targette laiton chromé 70 mm	-	-	-	00900871	20	-	00100871	00193130 NS	00192130 NS	00194130	-	10	-
Targette laiton laqué blanc 30 mm	-	-	-	00900832	20	-	00100832	00193123 NS	00192123 NS	00194123	-	10	-
Targette laiton laqué blanc 40 mm	-	-	-	00900842	20	-	00100842	00193124 NS	00192124 NS	00194124	-	10	-
Targette laiton laqué blanc 50 mm	-	-	-	00900852	20	-	00100852	00193125 NS	00192125 NS	00194125	-	10	-
Targette laiton laqué blanc 70 mm	-	-	-	00900872	20	-	00100872	00193126 NS	00192126 NS	00194126	-	10	-

NS Non stocké/Non-stored/Producto no estocado - ☐ Sur stock Europe Zone 1 et Zone 2, nous consulter pour délai d'approvisionnement - ☒ Epuisement/Stock depletion/Agotamiento del stock

Targette / PÊNE PLAT PROTECT



GARANTIE

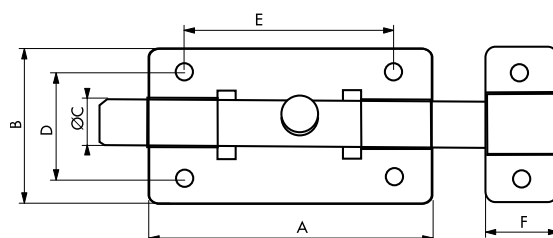

	002075	002100	002155
A	51	75	100
B	39	44	54
C	6	13	15
D	25	29	38
E	37	57	76
F	13	19	25

Description/Description/Descripción

Coffre alliage moulé. Pêne plat coulissant. Bouton rond.
Moulded alloy case. Sliding flat bolt. Turned knob.
Cuerpo de aleación moldeada. Pestillo plano deslizante.
Botón escotado.

Finition/Finish/Acabado

Nickel satin
Nickel satin
Níquel satinado

Designation	Boite	Colis.	Prix	Sachet	Colis.	Prix	Brochable					Colis.	Prix
							France	Euro 1	Euro 2	Euro 3	Euro 4		
Targette 45 mm	-	-	-	00902075	10	-	00102075	00193895 NS	00192895 NS	00194895	-	10	-
Targette 100 mm	-	-	-	00902100	10	-	00102100	00193896 NS	00192896 NS	00194896	-	10	-
Targette 150 mm	-	-	-	00902155	10	-	00202155	00293897 NS	00292897 NS	00294897	-	10	-

NS Non stocké/Non-stored/Producto no estocado - Sur stock Europe Zone 1 et Zone 2, nous consulter pour délai d'approvisionnement - E Epuisement/Stock depletion/Agotamiento del stock

Targette / PÊNE ROND PROTECT



GARANTIE

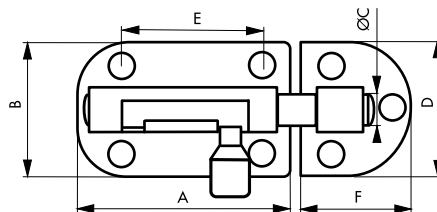

	003075	003100	003150	003200
A	48	73	120	170
B	34	34	34	34
C	8	8	8	8
D	24	24	24	24
E	24	39	28/59	
F	26	30	30	30

Description/Description/Descripción

Coffre alliage moulé. Pêne rond coulissant. Bouton rond.
Moulded alloy case. Sliding round bolt. Turned knob.
Cuerpo de aleación moldeada. Pestillo redondo deslizando. Botón escotado.

Finition/Finish/Acabado

Nickel satin
Nickel satin
Níquel satinado

Designation	Boite	Colis.	Prix	Sachet	Colis.	Prix	Brochable					Colis.	Prix
							France	Euro 1	Euro 2	Euro 3	Euro 4		
Targette 75 mm	-	-	-	00903075	5	-	00103075	00193900 NS	00192900 NS	00194900	-	10	-
Targette 100 mm	-	-	-	00903100	5	-	00103100	00193901 NS	00192901 NS	00194901	-	10	-
Targette 150 mm	-	-	-	00903150	5	-	00203150	00193902 NS	00192902 NS	00194902	-	10	-
Targette 200 mm	-	-	-	00903200	5	-	00203200	00193903 NS	00192903 NS	00194903	-	10	-

NS Non stocké/Non-stored/Producto no estocado - ☐ Sur stock Europe Zone 1 et Zone 2, nous consulter pour délai d'approvisionnement - E Epuisement/Stock depletion/Agotamiento del stock

Targette / PÊNE ROND PROTECT



GARANTIE

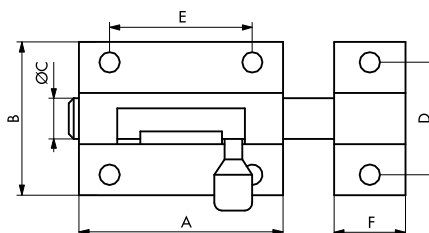
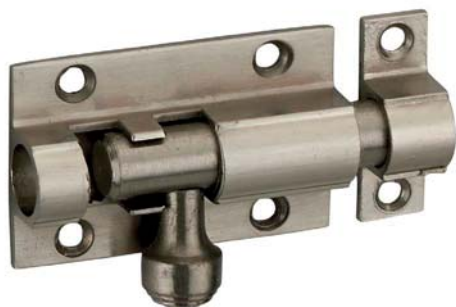

	004052	004062	004072	004102	004156	004202	004252	004302
A	50	63	76	101	151	202	253	305
B	32	32	32	32	32	32	32	32
C	10	10	10	10	10	10	10	10
D	24	24	24	24	24	24	24	24
E	31	48	48	35	63	85	114	90
F	10	10	10	10	10	10	10	10

Description/Description/Descripción

Coffre alliage moulé. Pêne rond coulissant. Bouton rond.
Moulded alloy case. Sliding round bolt. Turned knob.
Cuerpo de aleación moldeada. Pestillo redondo deslizando. Botón escotado.

Finition/Finish/Acabado

Nickel satin
Nickel satin
Níquel satinado

Designation	Boite	Colis.	Prix	Sachet	Colis.	Prix	Brochable					Colis.	Prix
							France	Euro 1	Euro 2	Euro 3	Euro 4		
Targette 50 mm	-	-	-	00904052	10	-	00104052	00193904 NS	00192904 NS	00194904	-	10	-
Targette 60 mm	-	-	-	00904062	10	-	00104062	00193905 NS	00192905 NS	00194905	-	10	-
Targette 75 mm	-	-	-	00904072	10	-	00104072	00193906 NS	00192906 NS	00194906	-	10	-
Targette 100 mm	-	-	-	00904102	10	-	00104102	00193907 NS	00192907 NS	00194907	-	10	-
Targette 150 mm	-	-	-	00904156	10	-	00204156	00293908 NS	00292908 NS	00294908	-	10	-
Targette 200 mm	-	-	-	00904202	10	-	00404202	00493909 NS	00492909 NS	00494909	-	10	-
Targette 250 mm	-	-	-	00904252	10	-	00404252	00493910 NS	00492910 NS	00494910	-	10	-
Targette 300 mm	-	-	-	00904302	10	-	00404302	00493911 NS	00492911 NS	00494911	-	10	-

NS Non stocké/Non-stored/Producto no estocado - Sur stock Europe Zone 1 et Zone 2, nous consulter pour délai d'approvisionnement - E Epuisement/Stock depletion/Agotamiento del stock

Targette / PÊNE PLAT PROTECT



GARANTIE

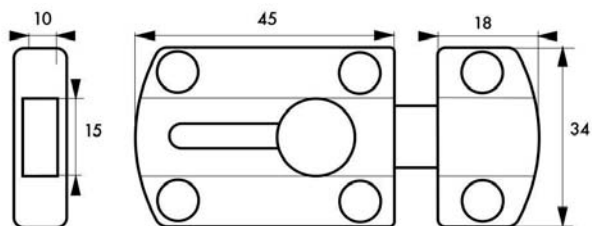

Description/Description/Descripción

Coffre alliage moulé. Pêne plat coulissant. Bouton rond.
Moulded alloy case. Sliding flat bolt. Turned knob.
 Cuerpo de aleación moldeada. Pestillo plano deslizante.
 Botón escotado.

Finition/Finish/Acabado

Nickel satin
Nickel satin
 Níquel satinado

Designation	Boite	Colis.	Prix	Sachet	Colis.	Prix	Brochable					Colis.	Prix
							France	Euro 1	Euro 2	Euro 3	Euro 4		
Targette 45 mm	-	-	-	00903045	5	-	00103045	00193898 NS	00192898 NS	00194898	-	10	-

NS Non stocké/Non-stored/Producto no estocado - Sur stock Europe Zone 1 et Zone 2, nous consulter pour délai d'approvisionnement - E Epusement/Stock depletion/Agotamiento del stock

Targette / LOUIS XVI PROTECT

Ces targettes offrent un style et une décoration soignées.



GARANTIE

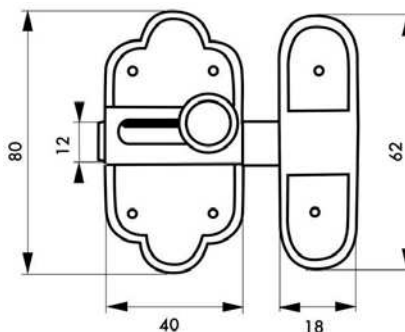

Description/Description/Descripción

Platine zamak. Gâche zamak. Pêne plat coulissant.
Zamak plate. Zamak striker. Sliding flat bolt.
Pletina de zamak. Cerradero de zamak. Pestillo plano deslizando.

Finition/Finish/Acabado

Laiton patiné
Polished brass
Latón pulido

Designation	Boîte	Colis.	Prix	Sachet	Colis.	Prix	Brochable					Colis.	Prix
							France	Euro 1	Euro 2	Euro 3	Euro 4		
Targette LOUIS XVI laiton patiné 40 x 80 mm	-	-	-	00916131	10	-	00116131	00193134	00192134	00194134	-	10	-



Targette / RUSTIQUE PROTECT

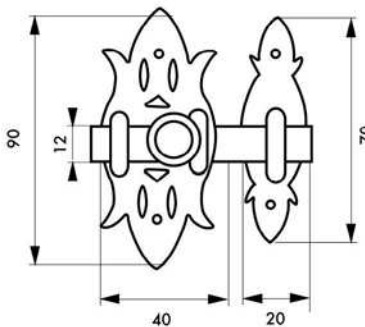

GARANTIE

Description/Description/Descripción

Platine acier. Gâche acier. Pêne plat coulissant.
Steel plate. Steel striker. Sliding flat bolt.
Cuerpo de Pletina de acero. Cerradero de acero. Pestillo plano deslizando.

Finition/Finish/Acabado

Fer noir. Fer patiné. Laiton patiné.
Black iron. Polished iron. Polished brass.
Fero negro. Fero pulido. Latón pulido.

Designation	Boîte	Colis.	Prix	Sachet	Colis.	Prix	Brochable					Colis.	Prix
							France	Euro 1	Euro 2	Euro 3	Euro 4		
Targette RUSTIQUE fer noir 40 x 90 mm	-	-	-	00905302	15	-	00105302	00193135 NS	00192135 NS	00194135	-	10	-
Targette RUSTIQUE fer noir 40 x 130 mm	-	-	-	00901415	10	-	00101415	-	-	-	-	10	-
Targette RUSTIQUE fer patiné 40 x 90 mm	-	-	-	00905303	10	-	00105303	00193136 NS	00192136 NS	00194136	-	10	-
Targette RUSTIQUE fer patiné 40 x 130 mm	-	-	-	00901416	10	-	00101416	-	-	-	-	10	-
Targette RUSTIQUE laiton patiné 40 x 90 mm	-	-	-	00905304	10	-	00105304	00193137	00192137 NS	00194137	-	10	-
Targette RUSTIQUE laiton patiné 40 x 130 mm	-	-	-	00901417	10	-	00101417	-	-	-	-	10	-

NS Non stocké/Non-stored/Producto no estocado - Sur stock Europe Zone 1 et Zone 2, nous consulter pour délai d'approvisionnement - E Epuisement/Stock depletion/Agotamiento del stock

Targette / PÊNE ROND RESIST

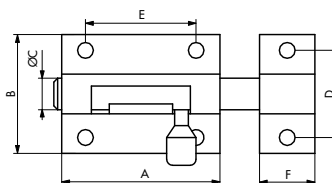

GARANTIE

	109031	109032
A	38	50
B	26	27
C	6	6
D	20	20
E	25	34
F	12	12

Description/Description/Descripción

Corps inox cambré. Gâche inox cambré. Bouton inox décollété. Pêne rond coulissant.
Cambered stainless steel case. Cambered stainless steel striker. Turned stainless steel knob. Sliding round bolt.
 Cuerpo de acero inoxidable curvado. Cerradero de acero inoxidable escotado. Botón de acero inoxidable escotado. Pestillo redondo deslizante.

Finition/Finish/Acabado

Inox
 Silver
 Plata

Designation	Boite	Colis.	Prix	Sachet	Colis.	Prix	Brochable					Colis.	Prix
							France	Euro 1	Euro 2	Euro 3	Euro 4		
Targette inox pêne rond 38 mm	-	-	-	00909031	10	-	00109031	00193323 NS	00192323 NS	00194323	-	10	-
Targette inox pêne rond 50 mm	-	-	-	00909032	10	-	00109032	00193324 NS	00192324 NS	00194324	-	10	-

Targette / PÊNE PLAT RESIST

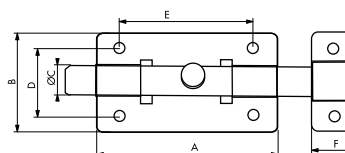

GARANTIE

	013913	013914	013915
A	51	75	64,5
B	37	42	44
C	6	12	18
D	22,5	32	33
E	37	56	45
F	13,5	19,5	25

Description/Description/Descripción

Corps inox. Gâche inox. Bouton inox. Pêne plat coulissant.
Stainless steel case. Stainless steel striker. Turned stainless steel knob. Sliding flat bolt.
 Cuerpo de acero inoxidable. Cerradero de acero inoxidable. Botón de acero inoxidable escotado. Pestillo plano deslizante.

Finition/Finish/Acabado

Inox
 Silver
 Plata

Designation	Boite	Colis.	Prix	Sachet	Colis.	Prix	Brochable					Colis.	Prix
							France	Euro 1	Euro 2	Euro 3	Euro 4		
Targette inox pêne plat 50 mm	-	-	-	00913913	10	-	00113913	00193722 NS	00192722 NS	00194722	-	10	-
Targette inox pêne plat 75 mm	-	-	-	00913914	10	-	00113914	00193723 NS	00192723 NS	00194723	-	10	-
Targette inox pêne plat 65 mm	-	-	-	00913915	10	-	00113915	00193724 NS	00192724 NS	00194724	-	10	-

NS Non stocké/Non-stored/Producto no estocado - ☐ Sur stock Europe Zone 1 et Zone 2, nous consulter pour délai d'approvisionnement - E Epuisement/Stock depletion/Agotamiento del stock

Verrou automatique / PÊNE PLAT RESIST



GARANTIE

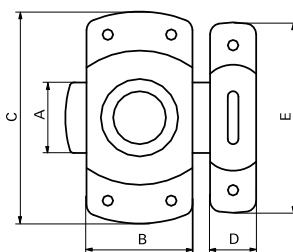

	25 mm	35 mm	40 mm
A	20	22	25
B	30	35	40
C	60	70	80
D	13	17	17
E	54	70	70

Description/Description/Descripción

Coffre laiton embouti chromé. Gâche laiton embouti chromé. Bouton laiton molleté. Pêne acier chromé.
Pressed brass case. Pressed brass striker. Brass knob. Brass bolt.

Caja de latón embutido. Cerradero de latón embutido. Botón de latón grafilado. Pestillo de latón.

Finition/Finish/Acabado

Acier laqué blanc
White lacquered steel
Acero lacado blanco

Designation	Boite	Colis.	Prix	Sachet	Colis.	Prix	Brochable					Colis.	Prix
							France	Euro 1	Euro 2	Euro 3	Euro 4		
Verrou 30 mm laiton chromé	-	-	-	00900931	10	-	00100931	00193249	00192249	00194249	-	10	-
Verrou 35 mm laiton chromé	-	-	-	00900936	10	-	00100936	00193250	00192250	00194250	-	10	-
Verrou 40 mm laiton chromé	-	-	-	00900941	10	-	00100941	00193253	00192253	00194253	-	10	-
Verrou 30 mm laqué blanc	-	-	-	00900929	10	-	00100929	00193251	00192251	00194251	-	10	-
Verrou 35 mm laqué blanc	-	-	-	00900934	10	-	00100934	00193252	00192252	00194252	-	10	-
Verrou 40 mm laqué blanc	-	-	-	00900939	10	-	00100939	00193200	00192200	00194200	-	10	-

NS Non stocké/Non-stored/Producto no estocado - Sur stock Europe Zone 1 et Zone 2, nous consulter pour délai d'approvisionnement - E Epuisement/Stock depletion/Agotamiento del stock

Verrou / A LARDER

ECO



GARANTIE



X 1

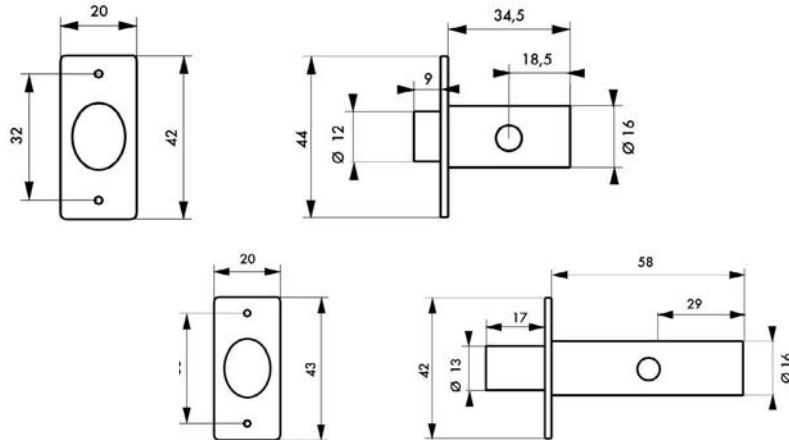

Description/Description/Descripción

Corps acier. Pêne alliage. Mécanisme à 1 tour. 1 clé.
Steel case. Moulded alloy bolt. One turn mechanism. 1 key.

Cuerpo de acero. Pestillo de aleación. Mecanismo de 1 vuelta. 1 llave.

Finition/Finish/Acabado

Laitonné

Brass plated

Latonado

Version/Option/Versión

Pêne long

Long bolt

Pestillo largo

Utilisation/Use/Utilización

A encaster sur fenêtre en bois.

Mortise fixing on wooden window.

Para empotrar en ventanas de madera.

Designation	Boite	Colis.	Prix	Sachet	Colis.	Prix	Brochable					Colis.	Prix
							France	Euro 1	Euro 2	Euro 3	Euro 4		
Verrou à larder avec clé entraîneur pour tous types de fenêtres bois	-	-	-	-	-	-	00100413	-	-	-	-	10	-
Verrou à larder avec clé entraîneur pour tous types de fenêtres bois pêne long	-	-	-	-	-	-	00100419	-	-	00194265	-	10	-

⚠ Non stocké/Non-stored/Producto no estocado - 📦 Sur stock Europe Zone 1 et Zone 2, nous consulter pour délai d'approvisionnement - 📦 Epuisement/Stock depletion/Agotamiento del stock

Verrou / POUR BAIE COULISSANTE ECO

DISPONIBLE JUSQU'À
ÉPUISEMENT DES STOCKS

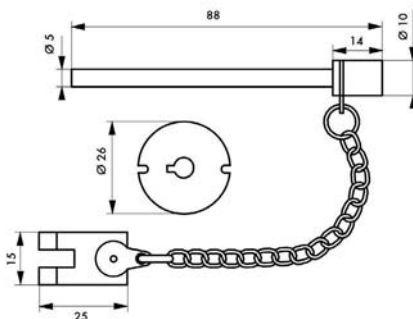

GARANTIE

Description/Description/Descripción

Goupille acier avec chaînette. Gâche acier. Support acier.
Steel pin with chain. Steel striker. Steel plate.
Pasador de acero con cadena. Cerradero de acero. So-
porte de acero.

Finition/Finish/Acabado

Nickelé
Nickel plated
Niquelado

Utilisation/Use/Utilización

Blocage de baie coulissante, barre, tringle de
crémone.
Sliding window closing.
Bloqueo de ventana corredera, barra, tranca de falleba.

Designation	Boite	Colis.	Prix	Sachet	Colis.	Prix	Brochable					Colis.	Prix
							France	Euro 1	Euro 2	Euro 3	Euro 4		
Goupille à chaînette	-	-	-	-	-	-	00100418	-	-	-	-	10	-

Verrou / LOQUETEAU ECO

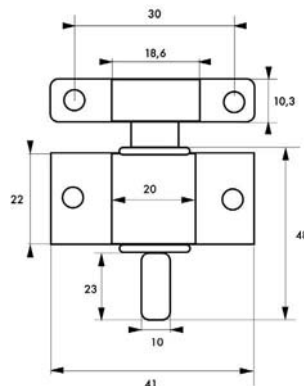

GARANTIE

Description/Description/Descripción

Corps alliage moulé.
Moulded alloy case.
Cuerpo de aleación moldeada.

Finition/Finish/Acabado

Laqué blanc
White lacquered
Lacado blanco

Utilisation/Use/Utilización

Pour vasistas .
For roof windows opening fully towards the
inside.
Para ventana abatible interior.

Designation	Boite	Colis.	Prix	Sachet	Colis.	Prix	Brochable					Colis.	Prix
							France	Euro 1	Euro 2	Euro 3	Euro 4		
Loqueteau de fenêtre blanc vertical	-	-	-	00900426	10	-	00100426	00193808 NS	00192808 NS	00194808	-	10	-

NS Non stocké/Non-stored/Producto no estocado - S Sur stock Europe Zone 1 et Zone 2, nous consulter pour délai d'approvisionnement - E Epuisement/Stock depletion/Agotamiento del stock

Verrou / LOQUETEAU ECO

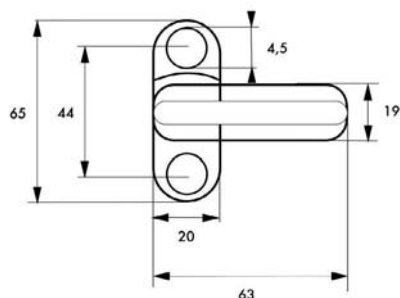

GARANTIE

Description/Description/Descripción

Corps alliage moulé. Câble pour recouvrement.
Moulded alloy case. Stop for cover.
Cuerpo de aleación moldeada. Calce para recubrimiento.

Finition/Finish/Acabado

Laqué blanc
White lacquered
Lacado blanco

Utilisation/Use/Utilización

Pour porte ou fenêtre OF/OB 1 vantail.
For casement or pivoted single pane windows
or doors.
Para puerta o ventana OF/OB 1 hoja.

Designation	Boite	Colis.	Prix	Sachet	Colis.	Prix	Brochable					Colis.	Prix
							France	Euro 1	Euro 2	Euro 3	Euro 4		
Loqueteau de fenêtre blanc	-	-	-	00900423	10	-	00100423	00193809 NS	00192809 NS	00194809	-	10	-

Verrou / LOQUETEAU ECO

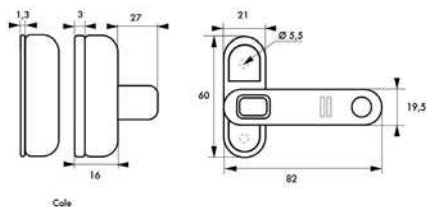

GARANTIE

Description/Description/Descripción

Corps alliage moulé. Alarme sonore 110db. Câble pour recouvrement.
Moulded alloy case. Sound alarm 110db. Stop for cover.
Cuerpo de aleación moldeada. Alarma sonora 110db.
Calce para recubrimiento

Finition/Finish/Acabado

Laqué blanc
White lacquered
Lacado blanco

Utilisation/Use/Utilización

Pour porte ou fenêtre OF/OB 1 vantail.
For casement or pivoted single pane windows
or doors.
Para puerta o ventana OF/OB 1 hoja.

Designation	Boite	Colis.	Prix	Sachet	Colis.	Prix	Brochable					Colis.	Prix
							France	Euro 1	Euro 2	Euro 3	Euro 4		
Loqueteau de fenêtre blanc avec alarme	-	-	-	00912060	10	-	00112060	00193248	00192248	00193248	-	10	-

NS Non stocké/Non-stored/Producto no estocado - M Sur stock Europe Zone 1 et Zone 2, nous consulter pour délai d'approvisionnement - E Epuisement/Stock depletion/Agotamiento del stock

Verrou / A CLE UNIVERSELLE PROTECT

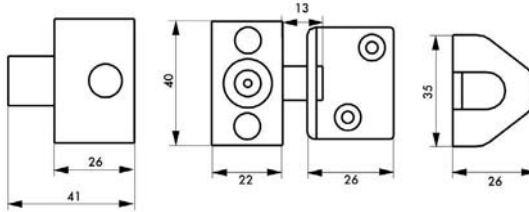

GARANTIE



X 1

Description/Description/Descripción

Corps alliage moulé. Gâche équerre. Gâche plate. 1 clé.
Moulded alloy case. Angle striker. Flat striker. 1 key.
Cuerpo de aleación moldeada. Cerradero escuadra. Cerradero plano. 1 llave.

Finition/Finish/Acabado

Nickelé
Nickel plated
Niquelado

Utilisation/Use/Utilización

Pose sur fenêtre ouvrant à la française, à guillotine, pivotante.
Fitting on window. French opening. Colocación en ventana con apertura a la francesa, de guillotina, giratoria.

Designation	Boite	Colis.	Prix	Sachet	Colis.	Prix	Brochable					Colis.	Prix
							France	Euro 1	Euro 2	Euro 3	Euro 4		
Verrou universel pour fenêtre à la française, bois et métal, à guillotine, pivotante	-	-	-	-	-	-	00100416	-	-	-	-	10	-



Verrou / A CLE UNIVERSELLE PROTECT

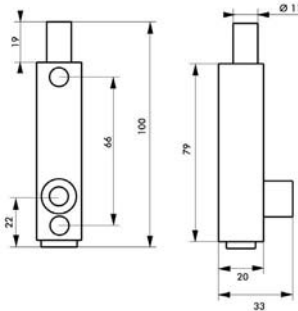

GARANTIE



X 1

Description/Description/Descripción

Corps alliage moulé. Gâche plate. Gâche manchon. 1 clé
Moulded alloy case. Flat striker. Ferrule striker. 1 key.
Cuerpo de aleación moldeada. Cerradero plano. Cerradero manguito.

Finition/Finish/Acabado

Laqué blanc
White lacquered
Lacado blanco

Utilisation/Use/Utilización

Pose sur tous types de fenêtres, portes.
Fitting on all types of windows, doors. Colocación en todo tipo de ventanas y puertas.

Designation	Boite	Colis.	Prix	Sachet	Colis.	Prix	Brochable					Colis.	Prix
							France	Euro 1	Euro 2	Euro 3	Euro 4		
Verrou universel pour fenêtre, porte bois et métal	-	-	-	-	-	-	00100417	-	-	00194271	-	10	-

Non stocké/Non-stored/Producto no estocado - Sur stock Europe Zone 1 et Zone 2, nous consulter pour délai d'approvisionnement - E Epuement/Stock depletion/Agotamiento del stock

Verrou / LOQUETEAU A CLE PROTECT

DISPONIBLE JUSQU'À
ÉPUISEMENT DES STOCKS

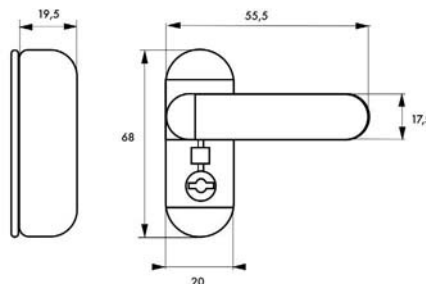

GARANTIE



X 1

Description/Description/Descripción

Corps alliage moulé. Câble pour recouvrement. 1 clé.
Moulded alloy case. Stop for cover. 1 key.
Cuerpo de aleación moldeada. Calce para recubrimiento.
1 llave.

Finition/Finish/Acabado

Laqué blanc
White lacquered
Lacado blanco

Utilisation/Use/Utilización

Pose en applique sur fenêtre bois avec dormant en saillie.
Surface fitting on wood window with projecting window frame.
Montage en plastron pour ventana de madera con durmiente en saliente.

Designation	Boite	Colis.	Prix	Sachet	Colis.	Prix	Brochable					Colis.	Prix
							France	Euro 1	Euro 2	Euro 3	Euro 4		
Loqueteau de fenêtre à clé en applique sur fenêtre avec dormant en saillie - blanc	-	-	-	00912061	10	-	00112061	-	-	-	-	10	-

Verrou / LOQUETEAU A CLE PROTECT

DISPONIBLE JUSQU'À
ÉPUISEMENT DES STOCKS

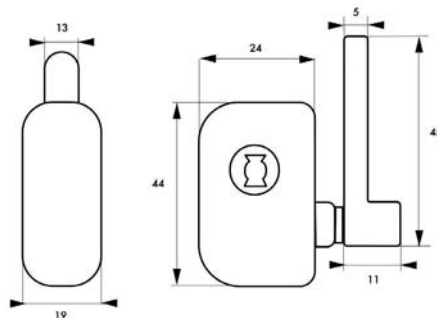

GARANTIE



X 1

Description/Description/Descripción

Corps alliage moulé. Câble pour recouvrement. 1 clé.
Moulded alloy case. Stop for cover. 1 key.
Cuerpo de aleación moldeada. Calce para recubrimiento.
1 llave.

Finition/Finish/Acabado

Laqué blanc
White lacquered
Lacado blanco

Utilisation/Use/Utilización

Pour porte ou fenêtre OF/OB 1 vantail.
For casement or pivoted single pane windows or doors.
Para puerta o ventana OF/OB 1 hoja.

Designation	Boite	Colis.	Prix	Sachet	Colis.	Prix	Brochable					Colis.	Prix
							France	Euro 1	Euro 2	Euro 3	Euro 4		
Loqueteau de fenêtre à clé pour porte ou fenêtre OF/OB 1 vantail - blanc	-	-	-	00912062	10	-	00112062	00193246	00192246	-	-	10	-

Ⓜ Non stocké/Non-stored/Producto no estocado - Ⓜ Sur stock Europe Zone 1 et Zone 2, nous consulter pour délai d'approvisionnement - Ⓜ Epuiement/Stock depletion/Agotamiento del stock

Verrou / A CYLINDRE RESIST

DISPONIBLE JUSQU'À
ÉPUISEMENT DES STOCKS

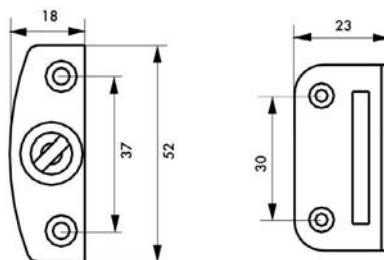

GARANTIE



X 2

Description/Description/Descripción

Corps alliage moulé. Gâche plate. Cylindre à paillettes. 2 clés laiton.

Moulded alloy case. Flat striker. disc-tumblers. 2 brass keys.

Cuerpo de aleación moldeada. Cerradero plano. Cilindro de plaquitas. 2 llaves de latón.

Finition/Finish/Acabado

Laqué blanc

White lacquered

Lacado blanco

Utilisation/Use/Utilización

Pose en applique sur fenêtre bois avec dormant en saillie.

Surface fitting on wood window with projecting window frame.

Montaje en plastrón para ventana de madera con durmiente en saliente.

Designation	Boite	Colis.	Prix	Sachet	Colis.	Prix	Brochable					Colis.	Prix
							France	Euro 1	Euro 2	Euro 3	Euro 4		
Verrou à cylindre pour fenêtre bois avec dormant en saillie - blanc	-	-	-	00900414	10	-	00100414	00193243	00192243	00194243	-	10	-

Verrou / A CYLINDRE RESIST

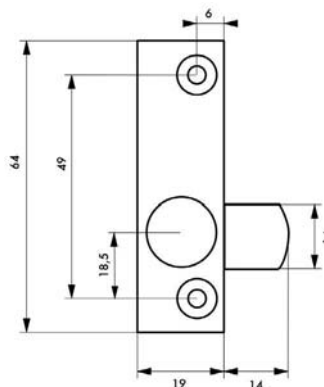

GARANTIE



X 1

Description/Description/Descripción

Corps alliage moulé. Cylindre à paillettes. 1 clé.

Moulded alloy case. Flat striker. Ferrule striker. 1 key

Cuerpo de aleación moldeada. Cerradero plano. Cerradero manguito.

Finition/Finish/Acabado

Laqué blanc

White lacquered

Lacado blanco

Utilisation/Use/Utilización

Pose en applique sur fenêtre bois avec dormant en saillie.

Surface fitting on wood window with projecting window frame.

Montaje en plastrón para ventana de madera con durmiente en saliente.

Designation	Boite	Colis.	Prix	Sachet	Colis.	Prix	Brochable					Colis.	Prix
							France	Euro 1	Euro 2	Euro 3	Euro 4		
Verrou à cylindre pour fenêtre métallique	-	-	-	00900415	10	-	00100415	-	-	-	-	10	-

⊗ Non stocké/Non-stored/Producto no estocado - ⊗ Sur stock Europe Zone 1 et Zone 2, nous consulter pour délai d'approvisionnement - ⊗ Epuisement/Stock depletion/Agotamiento del stock

Verrou / A CYLINDRE RESIST



GARANTIE



X 2

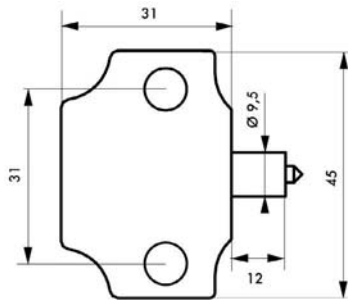

Description/Description/Descripción

Corps alliage moulé. Câble pour recouvrement. 1 clé.
Moulded alloy case. Stop for cover. 1 key.
 Cuerpo de aleación moldeada. Calce para recubrimiento.
 1 llave.

Finition/Finish/Acabado

Laqué blanc
White lacquered
 Lacado blanco

Utilisation/Use/Utilización

Pose en applique sur fenêtre bois avec dormant en saillie.
Surface fitting on wood window with projecting window frame.
 Montaje en plastrón para ventana de madera con durmiente en saliente.

Designation	Boite	Colis.	Prix	Sachet	Colis.	Prix	Brochable					Colis.	Prix
							France	Euro 1	Euro 2	Euro 3	Euro 4		
Verrou à cylindre avec pêne poussoir pour baie coulissante	-	-	-	00900421	10	-	00100421	00193244	00192244	00194244	-	10	-

⚠ Non stocké/Non-stored/Producto no estocado - 📦 Sur stock Europe Zone 1 et Zone 2, nous consulter pour délai d'approvisionnement - 📦 Epuisement/Stock depletion/Agotamiento del stock

Verrou / LOQUETEAU A CLE RESIST



GARANTIE



X 2

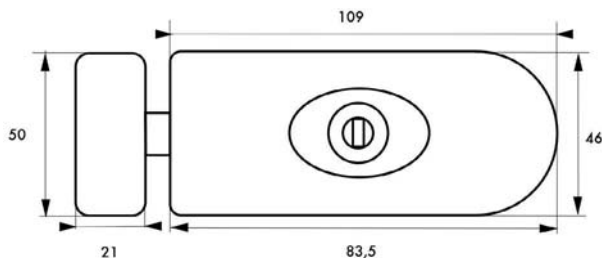

Description/Description/Descripción

Corps alliage moulé. Gâche plate. Cylindre à paillettes. 2 clés laiton.

Moulded alloy case. Flat striker. disc-tumblers. 2 brass keys.

Cuerpo de aleación moldeada. Cerradero plano. Cilindro de plaquitas. 2 llaves de latón.

Finition/Finish/Acabado

Laqué blanc

White lacquered

Lacado blanco

Utilisation/Use/Utilización

Pose en applique sur fenêtre bois avec dormant en saillie.

Surface fitting on wood window with projecting window frame.

Montage en plastrón para ventana de madera con durmiente en saliente.

Designation	Boîte	Colis.	Prix	Sachet	Colis.	Prix	Brochable					Colis.	Prix
							France	Euro 1	Euro 2	Euro 3	Euro 4		
Verrou de fenêtre - blanc - 2 clés	-	-	-	-	-	-	00228016	-	-	-	-	10	-

⊗ Non stocké/Non-stored/Producto no estocado - ☑ Sur stock Europe Zone 1 et Zone 2, nous consulter pour délai d'approvisionnement - ☒ Epuisement/Stock depletion/Agotamiento del stock

Verrou / FENETRE - BAIE COULISSANTE RESIST



GARANTIE



X 2

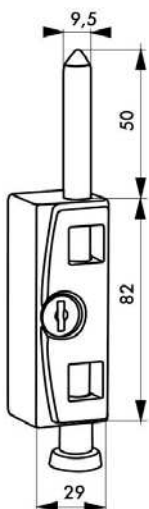
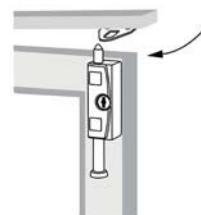
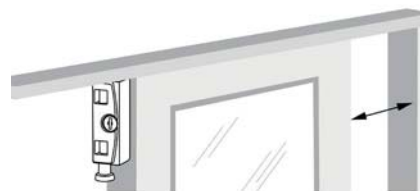

Description/Description/Descripción

Corps alliage. Tige et platine acier. 2 clés.
Moulded alloy case. Steel rod and plate. 2 keys.
Cuerpo de aleación moldeada. Vástago y platina de
acero. 2 llaves.

Finition/Finish/Acabado

Laqué blanc
White lacquered
Lacado blanco

Utilisation/Use/Utilización

Pour porte ou fenêtre OF ou coulissante bois / alu / PVC.
For casement or sliding door or window in wood/alumi-
nium/PVC.

Para puerta o ventana OF o deslizante de madera / alumi-
nio / PVC.

Designation	Boite	Colis.	Prix	Sachet	Colis.	Prix	Brochable					Colis.	Prix
							France	Euro 1	Euro 2	Euro 3	Euro 4		
Verrou de fenêtre et baie coulissante - blanc - 2 clés	-	-	-	00900428	10	-	00400428	00493240	00492240	00494240	-	10	-

⚠ Non stocké/Non-stored/Producto no estocado - 📦 Sur stock Europe Zone 1 et Zone 2, nous consulter pour délai d'approvisionnement - 📦 Epuisement/Stock depletion/Agotamiento del stock

Verrou / FENETRE - BAIE COULISSANTE RESIST



GARANTIE



X 2

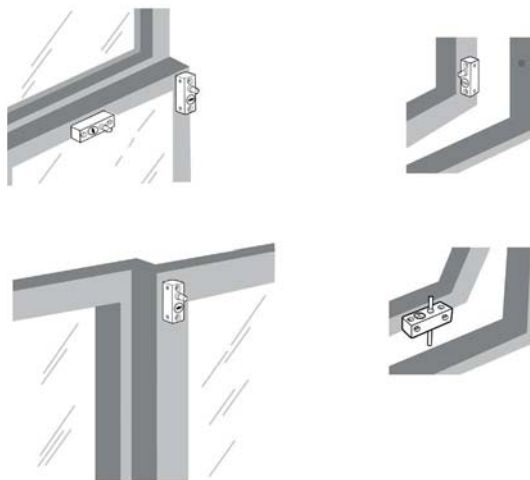
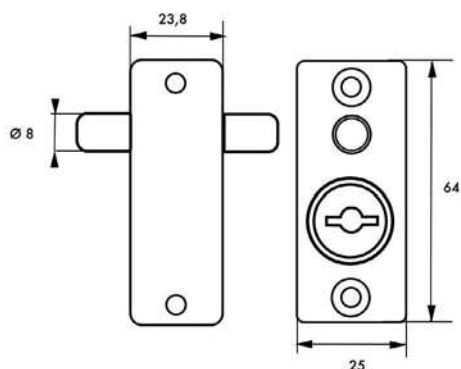

Description/Description/Descripción

Corps alliage. Tige acier. 2 clés. Livré avec 3 pênes.
Moulded alloy case. Steel rod. 2 keys. Delivered with 3 bolts.

Cuerpo de aleación moldeada. Vástago de acero. 2 llaves. Se entrega con 3 pestillos.

Finition/Finish/Acabado

Laqué blanc
White lacquered
Lacado blanco

Utilisation/Use/Utilización

Pour porte ou fenêtre OF ou coulissante bois / alu / PVC.
For casement or sliding door or window in wood/aluminium/PVC.

Para puerta o ventana OF o deslizante de madera / aluminio / PVC.

Designation	Boite	Colis.	Prix	Sachet	Colis.	Prix	Brochable					Colis.	Prix
							France	Euro 1	Euro 2	Euro 3	Euro 4		
Verrou à tige pour fenêtre et baie coulissante - blanc - 2 clés	-	-	-	00900429	10	-	00400429	00493241	00492241	00494241	-	10	-

⚠ Non stocké/Non-stored/Producto no estocado - 📦 Sur stock Europe Zone 1 et Zone 2, nous consulter pour délai d'approvisionnement - ⚠ Epuisement/Stock depletion/Agotamiento del stock

Verrou de sûreté / A COMBINAISON

PROTECT



GARANTIE



Clé pour modification de la combinaison

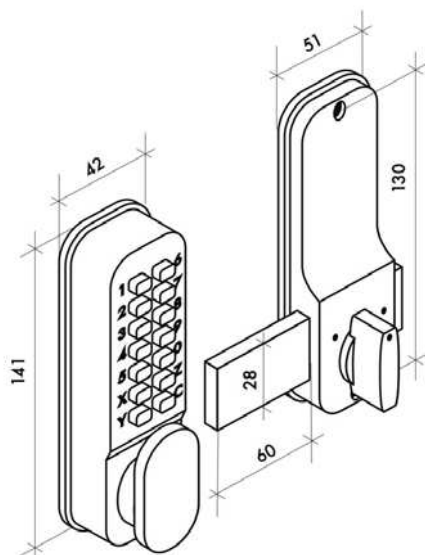

Description/Description/Descripción

Coffre en alliage moulé. Mécanisme à combinaison modifiable de 2 à 8 chiffres ou lettres. 8000 combinaisons possibles. Modification de la combinaison rapide. Réversible droite / gauche. Pour porte épaisseur 30 à 60 mm maxi.

Moulded alloy body. Removing combination mechanism from 2, 8 numbers. 8 000 combination available. Easy duty to change combination. Left or right hand. For door thickness 32 to 55 mm.

Caja de aleación moldeada. Mecanismo con combinación modificable de 2 a 8 cifras o letras. 8.000 combinaciones posibles. Modificación de la combinación rápida. Reversible derecha/izquierda. Para puerta 32 a 55 mm.

Finition/Finish/Acabado

Chromé mat
Dull chrome
Cromado mate

Utilisation/Use/Utilización

Porte d'entrée
Entrance door
Puerta de entrada

Designation	Boite	Colis.	Prix	Sachet	Colis.	Prix	Brochable				Colis.	Prix
							France	Euro 1	Euro 2	Euro 3		
Verrou à combinaison mécanique avec pêne dormant	00005009	1	-	-	-	-	-	-	-	-	-	-

⚠ Non stocké/Non-stored/Producto no estocado - ☑ Sur stock Europe Zone 1 et Zone 2, nous consulter pour délai d'approvisionnement - ☒ Epuisement/Stock depletion/Agotamiento del stock

Verrou de sûreté / A COMBINAISON

PROTECT



GARANTIE



Serrure de haute sûreté spécialement conçue pour les salles de sports, entrées d'immeubles, portes collectives.

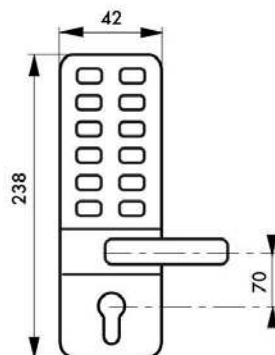

Description/Description/Descripción

Coffre en alliage moulé. Mécanisme à combinaison modifiable de 2 à 8 chiffres ou lettres. 8 000 combinaisons possibles. Modification de la combinaison rapide. Avec béquille double. Réversible droite / gauche. Pour porte épaisseur 32 à 55 mm maxi.

Moulded alloy body. Removing combination. mechanism from 2, 8 numbers. 8 000 combination available. Easy duty to change combination. Left or right hand. For door thickness 32 to 55 mm.

Caja de aleación moldeada. Mecanismo con combinación modificable de 2 a 8 cifras o letras. 8.000 combinaciones posibles. Modificación de la combinación rápida. Reversible derecha / izquierda. Para puerta 32 a 55 mm.

Finition/Finish/Acabado

Chromé mat
Dull chrome
Cromado mate

Utilisation/Use/Utilización

Porte d'entrée
Entrance door
Puerta de entrada

Designation	Boite	Colis.	Prix	Sachet	Colis.	Prix	Brochable				Colis.	Prix	
							France	Euro 1	Euro 2	Euro 3			Euro 4
Serrure avec poignée pour serrure à encastrer entraxe 70mm	00072696	1	-	-	-	-	00572696	-	-	-	-	2	-

Non stocké/Non-stored/Producto no estocado - Sur stock Europe Zone 1 et Zone 2, nous consulter pour délai d'approvisionnement - Epuement/Stock depletion/Agotamiento del stock

Verrou de sûreté / A COMBINAISON PROTECT



GARANTIE

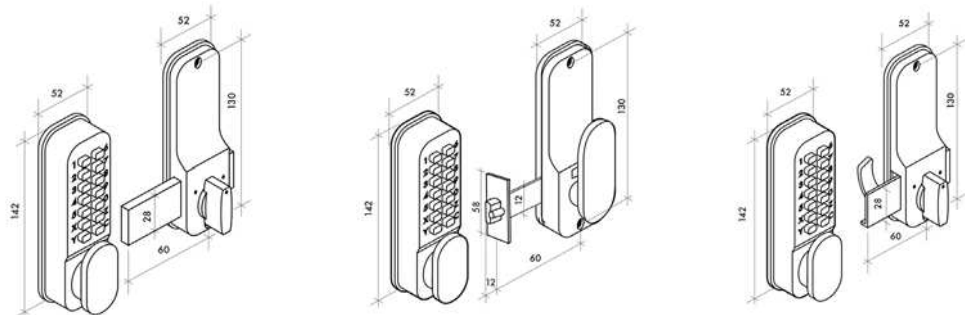

Description/Description/Descripción

Coffre en alliage moulé. Mécanisme à combinaison modifiable de 2 à 8 chiffres ou lettres. 8?000 combinaisons possibles. Modification de la combinaison rapide. Réversible droite / gauche. Pour porte épaisseur 32 à 55 mm maxi.

Moulded alloy body. Removing combination mechanism from 2, 8 numbers. 8 000 combination available. Easy duty to change combination. Left or right hand. For door thickness 32 to 55 mm.

Caja de aleación moldeada. Mecanismo con combinación modificable de 2 a 8 cifras o letras. 8.000 combinaciones posibles. Modificación de la combinación rápida. Reversible derecha/izquierda. Para puerta 32 a 55 mm.

Finition/Finish/Acabado

Chromé mat
Dull chrome
Cromado mate

Utilisation/Use/Utilización

Porte d'entrée
Entrance door
Puerta de entrada

Designation	Boite	Colis.	Prix	Sachet	Colis.	Prix	Brochable				Colis.	Prix	
							France	Euro 1	Euro 2	Euro 3			Euro 4
Verrou avec pêne dormant en applique	00072691	1	-	-	-	-	00572691	00593196	00592196	00594196	-	2	-
Verrou avec pêne 1/2 tour à encastrer	00072692	1	-	-	-	-	00572692	00593197	00592197	00594197	-	2	-
Serrure avec pêne à crochet pour porte coulissante	00072697	1	-	-	-	-	00572697	00593725	00592725	00594725	-	2	-

Non stocké/Non-stored/Producto no estocado - Sur stock Europe Zone 1 et Zone 2, nous consulter pour délai d'approvisionnement - Epuisement/Stock depletion/Agotamiento del stock

Verrou de sûreté / A COMBINAISON

PROTECT



GARANTIE

Spécialement conçue pour les salles de sports, entrées d'immeubles, portes collectives.

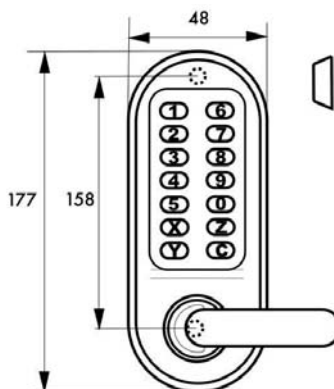

Description/Description/Descripción

Coffre en alliage moulé. Mécanisme à combinaison modifiable de 2 à 8 chiffres ou lettres. 8 000 combinaisons possibles. Modification de la combinaison rapide. Avec béquille double Carré 7mm. Réversible droite / gauche. Pour porte épaisseur 32 à 55 mm maxi. Livré avec jeu de rosaces pour cylindre profilé.

Moulded alloy body. Mechanism with combination from 2, 8 numbers. 8 000 combination available. Easy duty to change combination. Handle Square 7mm. Left or right hand. For door thickness 32 to 55 mm.

Caja de aleación moldeada. Mecanismo con combinación modificable de 2 a 8 cifras o letras. 8.000 combinaciones posibles. Modificación de la combinación rápida. Brazo doble Cuadrado 7mm Reversible derecha/izquierda. Para puerta 32 a 55 mm.

Finition/Finish/Acabado

Chromé mat
Dull chrome
Cromado mate

Version/Option/Versión

Pour utilisation d'un cylindre européen

For use with European cylinder

Para uso con cilindro europeo

Utilisation/Use/Utilización

Porte d'intérieur

Inside door

Puerta interior

Designation	Boite	Colis.	Prix	Sachet	Colis.	Prix	Brochable					Colis.	Prix
							France	Euro 1	Euro 2	Euro 3	Euro 4		
Verrou avec poignée pour serrure à encastrer (non fournie)	00072693	1	-	-	-	-	00572693	00593198 NS	00592198 NS	00594198	-	2	-

NS Non stocké/Non-stored/Producto no estocado - Sur stock Europe Zone 1 et Zone 2, nous consulter pour délai d'approvisionnement - E Epuisement/Stock depletion/Agotamiento del stock

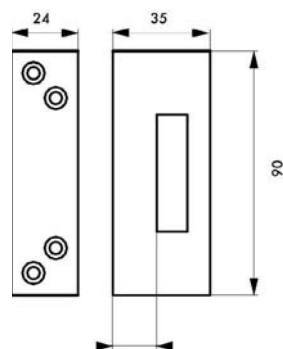
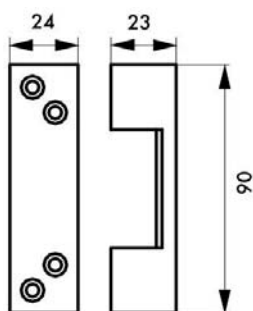

GARANTIE

Description/Description/Descripción

Gâche acier pour verrou de sûreté. Têtière acier version renforcée

Steel striker for safety bolt. Steel forend (for reinforced model).

Cerradero de acero para cerrojo de seguridad. Cabeza de acero versión reforzada.

Finition/Finish/Acabado

Epoxy bronze, beige

Bronze ,beige epoxy.

Epoxi bronze, beige.

Version/Option/Versión

Pour verrou type MIRAGE. Pour verrou type RAFALE.
For bolt MIRAGE. For bolt RAFALE.

Para cerrojo tipo MIRAGE. Para cerrojo tipo RAFALE.

Utilisation/Use/Utilización

Porte huisserie métallique. Porte à recouvrement

Steel door frame. Covering door frame

Puerta con marco metalico. Puerta que recubre el marco.

Designation	Boite	Colis.	Prix	Sachet	Colis.	Prix	Brochable					Colis.	Prix
							France	Euro 1	Euro 2	Euro 3	Euro 4		
Gâche pour huisserie métallique bronze	-	-	-	00901013	20	-	00101013	-	-	-	-	10	-
Gâche pour porte à recouvrement bronze	-	-	-	00901023	20	-	00101023	-	-	-	-	10	-
Gâche pour huisserie métallique beige	-	-	-	00901025	20	-	00101025	-	-	-	-	10	-
Gâche pour porte à recouvrement beige	-	-	-	00901026	20	-	-	-	-	-	-	-	-

Accessoires / GÂCHE RENFORCEE PROTECT



GARANTIE

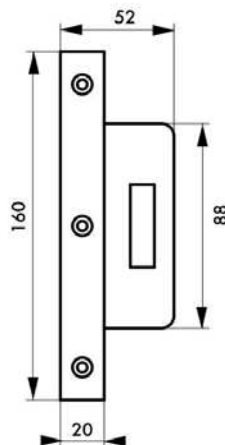
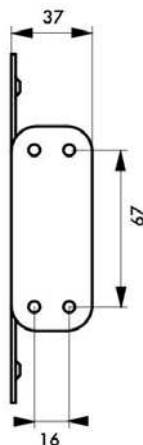

Description/Description/Descripción

Gâche acier pour verrou de sûreté. Têtière acier version renforcée.

Steel striker for safety bolt. Steel forend for reinforced model.

Cerradero de acero para cerrojo de seguridad. Cabeza de acero versión reforzada.

Finition/Finish/Acabado

Epoxy bronze, or.

Bronze, gold epoxy.

Epoxi bronze, oro.

Version/Option/Versión

Pour verrou type CORVETTE. Pour verrou type RAFALE.

Pour verrou type CAPITAL.

For bolt CORVETTE. For bolt RAFALE. For bolt CAPITAL.

Para cerrojo tipo CORVETTE. Para cerrojo tipo RAFALE.

Para cerrojo tipo CAPITAL.

Utilisation/Use/Utilización

Renforcée pour tous types de porte.

Strengthened security for all type of doors.

Reforzado para todo tipo de puertas.

Designation	Boite	Colis.	Prix	Sachet	Colis.	Prix	Brochable					Colis.	Prix
							France	Euro 1	Euro 2	Euro 3	Euro 4		
Gâche renforcée type Corvette epoxy bronze	-	-	-	-	-	-	00205013	-	-	-	-	10	-
Gâche renforcée type Rafale epoxy bronze	-	-	-	-	-	-	00205014	-	-	-	-	10	-

⚠ Non stocké/Non-stored/Producto no estocado - 📦 Sur stock Europe Zone 1 et Zone 2, nous consulter pour délai d'approvisionnement - ⚠ Epuisement/Stock depletion/Agotamiento del stock

Accessoires / PLAQUE DE RENFORT

PROTECT

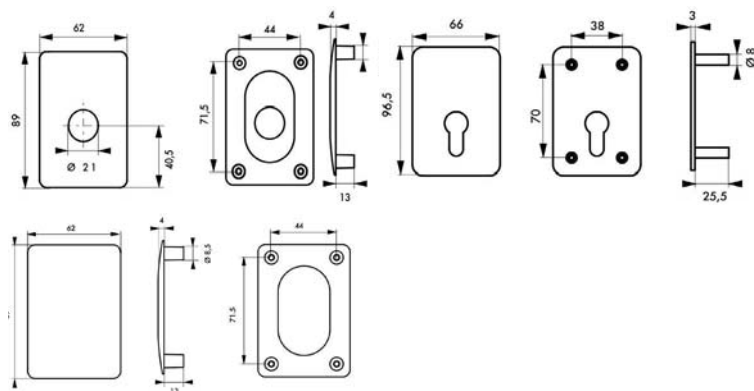

GARANTIE

Description/Description/Descripción

Alliage moulé. 001039-001239-009231-009232 : en acier. Fixation par vis métaux.

Moulded alloy. 001039-001239-009231-009232 : steel. Fixing steel screws.

Aleación moldeada. 001039-001239-009231-009232 : acero. Fijación con tornillos de metal.

Finition/Finish/Acabado

Epoxy bronze, blanc et beige. Chromé.

Bronze, white and beige epoxy. Chrome plated.

Epoxi bronce, blanco y beige. Cromado.

Version/Option/Versión

Pour verrou ETENDARD. Pour verrou CONCORDE. Pour verrous CORVETTE, TRANSIT 2. Pour verrou CAPITAL. Pour verrou SURVEYOR. Pour verrous CAPITAL, CONCORDE équipés de cylindres profilés. Sans trou de passage de cylindre.

For bolt ETENDARD. For bolt CONCORDE. For bolt CORVETTE and TRANSIT 2. For bolt CAPITAL. For bolt SURVEYOR. For bolt CAPITAL AND. CONCORDE with profile cylinder. Without cylinder hole.

Para cerrojo ETENDARD. Para cerrojo CONCORDE. Para cerrojos CORVETTE y TRANSIT 2. Para cerrojo CAPITAL. Para cerrojo SURVEYOR. Para cerrojos CAPITAL y CONCORDE equipados de cilindros perfilados. Sin orificio de paso de cilindro.

Utilisation/Use/Utilización

Sécurité renforcée tout types de porte. Nécessaire pour les portes isoplane.

Security reinforced all types of door. Required for isoplane doors.

Seguridad reforzada para todo tipo de puertas. Necesario para las puertas isoplane.

Designation	Boite	Colis.	Prix	Sachet	Colis.	Prix	Brochable					Colis.	Prix
							France	Euro 1	Euro 2	Euro 3	Euro 4		
Plaque de renfort pour porte isoplane type Etendard et Concorde époxy bronze	-	-	-	-	-	-	00101033	-	-	-	-	10	-
Plaque de renfort porte isoplane type Corvette époxy bronze	-	-	-	00903033	10	-	00103033	-	-	-	-	10	-
Plaque de renfort cylindre profilé type Corvette époxy bronze	00002036	1	-	00902036	10	-	00102036	-	-	-	-	-	-
Plaque de renfort porte isoplane type Capital et Transit 2 époxy or	00009231	10	-	00909231	10	-	00109231	-	-	-	-	10	-
Plaque de renfort pour porte isoplane type Surveyor époxy bronze	-	-	-	-	-	-	00107033	-	-	-	-	10	-
Plaque de renfort pour porte isoplane type Emerald époxy bronze	-	-	-	-	-	-	00107333	-	-	-	-	10	-
Plaque de renfort porte isoplane type Capital à cylindre profilé, époxy bronze	00001039	10	-	-	-	-	00101039	-	-	-	-	10	-
Plaque de renfort porte isoplane type Capital à cylindre profilé, époxy blanc	00001239	10	-	-	-	-	-	-	-	-	-	-	-
Plaque de renfort porte isoplane type Capital à cylindre profilé époxy or	00009232	10	-	-	-	-	-	-	-	-	-	-	-

⚠ Non stocké/Non-stored/Producto no estocado - 📦 Sur stock Europe Zone 1 et Zone 2, nous consulter pour délai d'approvisionnement - 📦 Epuisement/Stock depletion/Agotamiento del stock

Accessoires ENTREE / ROSACE

PROTECT



GARANTIE

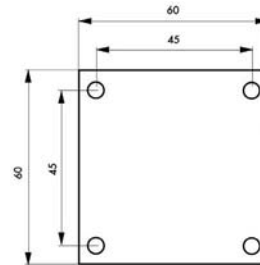
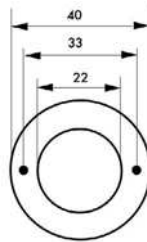
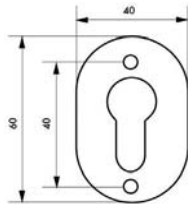
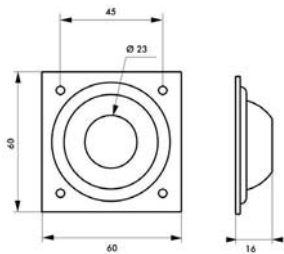

Description/Description/Descripción

Laiton embouti.

Stamped brass.

Latón embutido.

Finition/Finish/Acabado

Laiton. Laiton chromé.

Brass. Chrome plated brass.

Latón. Latón cromado.

Version/Option/Versión

A cuvette. Ø 22 pour cylindre Ø 21. Ø 24 pour cylindre Ø 23. Ø 26 pour cylindre Ø 26.

With cup. Ø 22 for cylinder Ø 21. Ø 24 for cylinder Ø 23. Ø 26 for cylinder Ø 26.

De cubeta para puerta. Ø 22 para cilindro Ø 21. Ø 24 para cilindro Ø 23. Ø 26 para cilindro Ø 26.

Designation	Boite	Colis.	Prix	Sachet	Colis.	Prix	Brochable					Colis.	Prix
							France	Euro 1	Euro 2	Euro 3	Euro 4		
Entrée à cuvette 60 x 60mm pour verrou de sûreté cyl. Ø 23 mm laiton	00041260	10	-	-	-	-	00141260	-	-	-	-	10	-
Entrée à cuvette 60 x 60mm pour verrou de sûreté cyl. Ø 23 mm laiton chromé	00041261	10	-	-	-	-	00141261	-	-	-	-	10	-
Rosace laitonée pour cylindre profilé	00082900	10	-	-	-	-	00182900	-	-	-	-	10	-
Rosace laiton Ø 22 mm	00096022	10	-	-	-	-	00196022	-	-	-	-	10	-
Rosace laiton Ø 24 mm	00096024	10	-	-	-	-	00196024	-	-	-	-	10	-
Rosace laiton Ø 26 mm	00096026	10	-	-	-	-	00196026	-	-	-	-	10	-
Plaque de propreté laiton 60 x 60	00041266	1	-	-	-	-	00141266	-	-	-	-	10	-

Non stocké/Non-stored/Producto no estocado - Sur stock Europe Zone 1 et Zone 2, nous consulter pour délai d'approvisionnement - Epuement/Stock depletion/Agotamiento del stock

Accessoires / LUBRIFIANT PROTECT



Lubrifiant utilisé dans nos atelier idéal pour l'entretien des cadenas, verrous, cylindres et serrures



GARANTIE

Description/Description/Descripción

Poudre graphite micronisée au Xenium
Xenium micronised graphite powder
Polvo de grafito micronizados al Xenium

Utilisation/Use/Utilización

Contre l'oxydation, la corrosion et le grippage des cylindres.

Against corrosion, rust and binding.

Contra la corrosión y agorrotamiento oxidación.

Designation	Boite	Colis.	Prix	Sachet	Colis.	Prix	Brochable					Colis.	Prix
							France	Euro 1	Euro 2	Euro 3	Euro 4		
Lubrifiant poudre graphite 95 ml pour cylindre	00096005	10	-	00996005	20	-	00296005	00293177 NS	00292177 NS	00294177	-	10	-

Accessoires / LUBRIFIANT PROTECT



Lubrifiant utilisé dans nos atelier idéal pour l'entretien des cadenas, verrous, cylindres et serrures



GARANTIE

Description/Description/Descripción

Lubra rapid. Spray lubrifiant non grassex.
Spray lubricant.
Lubricante

Utilisation/Use/Utilización

Contre l'oxydation, la corrosion et le grippage des cylindres.

Against corrosion, rust and binding.

Contra la corrosión y agorrotamiento oxidación.

Designation	Boite	Colis.	Prix	Sachet	Colis.	Prix	Brochable					Colis.	Prix
							France	Euro 1	Euro 2	Euro 3	Euro 4		
Spray lubrifiant 150ml pour cylindre	00010909	1	-	-	-	-	00210909	00293213 NS	00292213 NS	00294213	-	5	-
Présentoir de 20 spray lubrifiants 150 ml pour cylindre	00010919	1	-	-	-	-	-	-	-	-	-	-	-

Tarif conditionnement non décollable

Lubrifiant 150 ml pour cylindre (20 pièces)	00010929	20	-	-	-	-	-	-	-	-	-	-	-
---	----------	----	---	---	---	---	---	---	---	---	---	---	---

NS Non stocké/Non-stored/Producto no estocado - ☐ Sur stock Europe Zone 1 et Zone 2, nous consulter pour délai d'approvisionnement - ☒ Epuisement/Stock depletion/Agotamiento del stock

Accessoires-Suppléments / POUR VERROUS

Designation	Boite	Colis.	Prix	Sachet	Colis.	Prix	Brochable					Colis.	Prix
							France	Euro 1	Euro 2	Euro 3	Euro 4		
ACCESSOIRES / SUPPLEMENTS													
Pêne de verrou symétrique ou assymétrique de 115 à 140 mm	00001060	1	-	-	-	-	-	-	-	-	-	-	-
Pêne de verrou symétrique ou assymétrique jusqu'à 160 mm	00001061	1	-	-	-	-	-	-	-	-	-	-	-
Pêne de verrou symétrique ou assymétrique jusqu'à 200 mm	00001062	1	-	-	-	-	-	-	-	-	-	-	-
Pêne de verrou CP symétrique ou assymétrique de 115 à 140 mm	00001063	1	-	-	-	-	-	-	-	-	-	-	-
Pêne de verrou symétrique ou assymétrique jusqu'à 160 mm	00001064	1	-	-	-	-	-	-	-	-	-	-	-
Pêne de verrou symétrique ou assymétrique jusqu'à 200 mm	00001065	1	-	-	-	-	-	-	-	-	-	-	-
SUPPLEMENTS POUR VERROUS													
Supplément pour entr'ouverture (pour quantité < 50 pièces)	00063001	-	-	-	-	-	-	-	-	-	-	-	-
Supplément pour entr'ouverture hors standard (pour quantité < 50 pièces)	00063991	-	-	-	-	-	-	-	-	-	-	-	-
Supplément pour numéro imposé (pour quantité < 50 pièces)	00063071	-	-	-	-	-	-	-	-	-	-	-	-
Supplément pour combinaisons ouvrant sur passe-partout : verrou à bouton	00063019	-	-	-	-	-	-	-	-	-	-	-	-
Supplément pour combinaisons ouvrant sur passe-partout : verrou à dble cylindre	00056002	-	-	-	-	-	-	-	-	-	-	-	-
Clé passe-partout	00063020	-	-	-	-	-	-	-	-	-	-	-	-
Supplément pour pêne symétrique ou assymétrique de 115 à 140 mm	00001008	-	-	-	-	-	-	-	-	-	-	-	-
Supplément pour pêne jusqu'à 160 mm verrou RAFALE CP	00001003	-	-	-	-	-	-	-	-	-	-	-	-
Supplément pour pêne jusqu'à 160 mm verrou CAPITAL CP	00001004	-	-	-	-	-	-	-	-	-	-	-	-
Minoration pour non fourniture de Clé (prix net par Clé)	00063018	-	-	-	-	-	-	-	-	-	-	-	-
SUPPLEMENTS SPÉCIFIQUES POUR VERROUS SURVEYOR													
Supplément pour numéro imposé (pour quantité < 50 pièces)	00016700	-	-	-	-	-	-	-	-	-	-	-	-
Supplément mise sur passe général	00016701	-	-	-	-	-	-	-	-	-	-	-	-
Supplément mise sur passe général et passe-partiel	00016702	-	-	-	-	-	-	-	-	-	-	-	-



Designation	Boite	Colis.	Prix	Sachet	Colis.	Prix	Brochable					Colis.	Prix
							France	Euro 1	Euro 2	Euro 3	Euro 4		
SUPPLEMENTS SPÉCIFIQUES POUR VERROUS SURVEYOR													
Supplément mise sur combinaison centrale	00016703	-	-	-	-	-	-	-	-	-	-	-	-
Clé passe-partout	00016704	-	-	-	-	-	-	-	-	-	-	-	-
Clé passe-partiel	00016705	-	-	-	-	-	-	-	-	-	-	-	-
Minoration pour non fourniture de Clé (prix net par Clé)	00016707	-	-	-	-	-	-	-	-	-	-	-	-
SUPPLEMENTS SPÉCIFIQUES POUR VERROUS COBRA													
Supplément pour entr'ouverture (pour quantité < 50 pièces)	00017700	-	-	-	-	-	-	-	-	-	-	-	-
Supplément pour numéro imposé (pour quantité < 50 pièces)	00017709	-	-	-	-	-	-	-	-	-	-	-	-
Supplément mise sur passe général	00017701	-	-	-	-	-	-	-	-	-	-	-	-
Supplément mise sur passe général et passe partiel	00017702	-	-	-	-	-	-	-	-	-	-	-	-
Supplément mise sur combinaison centrale	00017703	-	-	-	-	-	-	-	-	-	-	-	-
Clé passe-partout	00017704	-	-	-	-	-	-	-	-	-	-	-	-
Clé passe-partiel	00017705	-	-	-	-	-	-	-	-	-	-	-	-
Minoration pour non fourniture de Clé (prix net par Clé)	-	-	-	-	-	-	-	-	-	-	-	-	-
SUPPLEMENTS POUR VERROUS TRANSIT 2 *													
Supplément pour entr'ouverture (pour quantité < 50 pièces)	00063001	-	-	-	-	-	-	-	-	-	-	-	-
Supplément pour entr'ouverture hors standard (pour quantité < 50 pièces)	00063991	-	-	-	-	-	-	-	-	-	-	-	-
Supplément pour numéro imposé (pour quantité < 50 pièces)	00018792	-	-	-	-	-	-	-	-	-	-	-	-
Minoration pour non fourniture de clé (prix net par clé)	00018794	-	-	-	-	-	-	-	-	-	-	-	-
Plus value verrou Transit 2 cylindre Transit Evolution	00057009	-	-	-	-	-	-	-	-	-	-	-	-
SUPPLEMENTS													
Supplément pour emballage avec antivol	00099010	-	-	-	-	-	-	-	-	-	-	-	-

Notes







Cylindres

CLÉ CRANTÉE	476	CLÉ RÉVERSIBLE	522
CLÉ À POMPE	539	CLÉ MAGNÉTIQUE	543
INDUSTRIE	551	SPÉCIFIQUE - ADAPTATEUR	556
ACCESSOIRES	565		



*Sommaire détaillé par produit
page suivante*





















*Chapitre BATTEUSE
page 574*



Cylindres



CLÉ CRANTÉE

Cylindre 5 goupilles SA laitonné - Vis de 40/45/50mm		476
Cylindre 5 goupilles SA nickelé - Vis de 40/45/50mm		478
Cylindre 5 goupilles SA laitonné		480
Cylindre 5 GOUPILLES SA		482
Cylindre de sûreté 5 GOUPILLES STD		484
Cylindre de sûreté 5 GOUPILLES STD		487
Cylindre de sûreté 5G STD URGENCE		490
Cylindre de sûreté 5G STD MODIFIABLE		491
Cylindre de sûreté HG 5		492
Cylindre de sûreté HG 5		495
Cylindre de sûreté HG 6		498
Cylindre de sûreté HG 6		501
Cylindre de sûreté HG5+		504
Cylindre de haute sûreté HG5+ POUR ORGANIGRAMME		506
Cylindre de sûreté HG6+		512
Cylindre de haute sûreté ADRIATIC 2		515
Cylindre de haute sûreté ADRIA POUR ORGANIGRAMME		516
Cylindre de haute sûreté ADRIATIC POUR ORGANIGRAMME		518





CLÉ RÉVERSIBLE

Cylindre de haute sûreté TRAFIC 6		522
Cylindre de haute sûreté TRAFIC 12		525
Cylindre de haute sûreté TRANSIT 1		526
Cylindre de haute sûreté TRANSIT 1		531
Cylindre de haute sûreté TRANSIT 2		532
Cylindre de haute sûreté TRANSIT 2 POUR ORGANIGRAMME		535



CLÉ À POMPE

Cylindre de haute sûreté SURVEYOR		539
Cylindre de haute sûreté COBRA 2 COBRA 2+ Évolution		541









CLÉ MAGNÉTIQUE

Cylindre de haute sûreté FEDERAL		543
Cylindre de haute sûreté FEDERAL S		545
Cylindre de haute sûreté FEDERAL 2		547
Cylindre de haute sûreté FEDERAL 2		548

INDUSTRIE

Cylindre de sûreté HG5 AVEC TRIANGLE		551
Cylindre de sûreté HG5 AVEC CARRÉ		554

SPÉCIFIQUE - ADAPTATEUR

Cylindre de sûreté OVALE		556
Cylindre RIM clé crantée		556
Cylindre RIM clé réversible		557
Cylindre de haute sûreté ADRIATIC À LANGUETTE		557
Cylindre de haute sûreté COBRA M		558
Cylindre de haute sûreté ADAPTATEUR LAP		558
Cylindre de haute sûreté ADAPTATEUR LAP		559
Cylindre de haute sûreté ADAPTATEUR PLX		559
Cylindre de haute sûreté COBRA M À LANGUETTE - SUJ		560
Cylindre de haute sûreté ADAPTATEUR CIS		560
Cylindre de haute sûreté ADAPTATEUR FIC		561
Cylindre de haute sûreté ADAPTATEUR BLCT		562
Cylindre de haute sûreté T2 FIC		563
Cylindre de haute sûreté ADAPTATEUR CAZ		564
Cylindre de haute sûreté TRANSIT 2 À LANGUETTE		564

ACCESSOIRES

OBTURATEUR		565
ENTRÉE ROSACE		565
Pour serrure à encastrer ADAPTATEUR CLE DE SERVICE		566
ANNEAU PORTE-ETIQUETTE		566
ANNEAU PORTE-ETIQUETTE		567
ANNEAU PORTE-ETIQUETTE		567
PORTE CLÉ ENROULEUR		568
PORTE CLÉ HÔTEL		568
Suppléments pour cylindres		570



Cylindre / 5 GOUPILLES SA

ECO



NIVEAU DE SÉCURITÉ



GARANTIE



X 3



Cylindres disponibles
avec vis de 40,45 ou 50mm



Protection
Arrachement



Description/Description/Descripción

Profil européen alliage. Mécanisme à 5 goupilles.
Panneton anti arrachement. 3 clés en acier nickelé.
*European brass profile. 5 pin mechanism. Driver cam
made of powdered metal. 3 nickel plated steel keys.*
Perfil europeo de aleación. Mecanismo con 5 pasadores.
Pivote de acero sinterizado. 3 llaves de acero niquelado.

Finition/Finish/Acabado

Laitonné / Brass finish / Latonado

Version/Option/Versión

Vis de 40 mm pour porte vitrée. Vis de 45 et 50 mm pour
porte PVC et aluminium. Vis de 60 mm pour porte bois.
Demi-cylindre 1 entrée. Cylindre 1 entrée à bouton.
*Screw 40 mm for glass doors. Screw 45 et 50 mm for PVC
and aluminium door. Screw 60 mm for wood door. 1/2
cylinder with key way. Cylinder with key way and inside
knob.*

Tornillo 40 mm para puerta de vidrio. Tornillo 45 y 50
mm para puerta de PVC u aluminio. Tornillo 60 mm para
puerta de madera. Semicilindro 1 entrada. Cilindro 1
entrada de botón.

Designation	Boite	Colis.	Prix	Sachet	Colis.	Prix	Brochable					Colis.	Prix
							France	Euro 1	Euro 2	Euro 3	Euro 4		
Demi-cylindre SA 30 x 10 mm laitonné 3 clés avec vis de 40 mm	00015946	10	-	-	-	-	-	-	-	-	-	-	-
Cylindre SA 40 x 40 mm laitonné 3 clés avec vis de 40 mm	00016304	10	-	-	-	-	-	-	-	-	-	-	-
Cylindre SA 40 x 40 mm laitonné 3 clés avec vis de 45 mm	00016327	10	-	-	-	-	-	-	-	-	-	-	-
Cylindre SA 45 x 45 mm laitonné 3 clés avec vis de 45 mm	00016328	10	-	-	-	-	-	-	-	-	-	-	-
Cylindre SA 30 x 35 mm laitonné 3 clés avec vis de 45 mm	00016300	10	-	-	-	-	-	-	-	-	-	-	-

⚠ Non stocké/Non-stored/Producto no estocado - 📦 Sur stock Europe Zone 1 et Zone 2, nous consulter pour délai d'approvisionnement - 📦 Epuisement/Stock depletion/Agotamiento del stock

Cylindre / 5 GOUPILLES SA ECO



NIVEAU DE SÉCURITÉ



Designation	Boite	Colis.	Prix	Sachet	Colis.	Prix	Brochable					Colis.	Prix
							France	Euro 1	Euro 2	Euro 3	Euro 4		
Cylindre SA 30 x 40 mm laitonné 3 clés avec vis de 45 mm	00016264	10	-	-	-	-	-	-	-	-	-	-	-
Cylindre SA 35 x 45 mm laitonné 3 clés avec vis de 45 mm	00016326	10	-	-	-	-	-	-	-	-	-	-	-
Demi-cylindre SA 30 x 10 mm laitonné 3 clés avec vis de 50 mm	00015945	10	-	-	-	-	-	-	-	-	-	-	-
Cylindre SA 30 x 30 mm laitonné 3 clés avec vis de 50 mm	00016252	10	-	-	-	-	-	-	-	-	-	-	-
Cylindre SA 35 x 35 mm laitonné 3 clés avec vis de 50 mm	00016277	10	-	-	-	-	-	-	-	-	-	-	-
Cylindre SA 40 x 40 mm laitonné 3 clés avec vis de 50 mm	00016305	10	-	-	-	-	-	-	-	-	-	-	-
Cylindre SA 45 x 45 mm laitonné 3 clés avec vis de 50 mm	00016308	10	-	-	-	-	-	-	-	-	-	-	-
Cylindre SA 30 x 35 mm laitonné 3 clés avec vis de 50 mm	00016301	10	-	-	-	-	-	-	-	-	-	-	-
Cylindre SA 30 x 40 mm laitonné 3 clés avec vis de 50 mm	00016267	10	-	-	-	-	-	-	-	-	-	-	-
Cylindre SA 30 x 50 mm laitonné 3 clés avec vis de 50 mm	00016284	10	-	-	-	-	-	-	-	-	-	-	-
Cylindre SA 35 x 45 mm laitonné 3 clés avec vis de 50 mm	00016302	10	-	-	-	-	-	-	-	-	-	-	-
Cylindre SA 40 x 45 mm laitonné 3 clés avec vis de 50 mm	00016307	10	-	-	-	-	-	-	-	-	-	-	-



Cylindre / 5 GOUPILLES SA

ECO



NIVEAU DE SÉCURITÉ



GARANTIE



X 3



Cylindres disponibles
avec vis de 40,45 ou 50mm



Protection
Arrachement



Description/Description/Descripción

Profil européen alliage. Mécanisme à 5 goupilles.
Panneton anti arrachement. 3 clés en acier nickelé.
*European alloy profile. 5 pin mechanism. Driver cam
made of powdered metal. 3 nickel plated steel keys.*
Perfil europeo de aleación. Mecanismo con 5 pasadores.
Pivote de acero sinterizado. 3 llaves de acero niquelado.

Finition/Finish/Acabado

Nickelé
Nickel plated
Niquelado

Version/Option/Versión

Vis de 40 mm pour porte vitrée. Vis de 45 et 50 mm pour
porte PVC et aluminium. Vis de 60 mm pour porte bois.
Demi-cylindre 1 entrée. Cylindre 1 entrée à bouton.
*Screw 40 mm for glass doors. Screw 45 et 50 mm for PVC
and aluminium door. Screw 60 mm for wood door. 1/2
cylinder with key way. Cylinder with key way and inside
knob.*

Tornillo 40 mm para puerta de vidrio. Tornillo 45 y 50
mm para puerta de PVC u aluminio. Tornillo 60 mm para
puerta de madera. Semicilindro 1 entrada. Cilindro 1
entrada de botón.

Designation	Boite	Colis.	Prix	Sachet	Colis.	Prix	Brochable					Colis.	Prix
							France	Euro 1	Euro 2	Euro 3	Euro 4		
Cylindre SA 40 x 40 mm nickelé 3 clés avec vis de 40 mm	00016318	10	-	-	-	-	-	-	-	-	-	-	-
Cylindre SA 45 x 45 mm nickelé 3 clés avec vis de 40 mm	00016322	10	-	-	-	-	-	-	-	-	-	-	-
Cylindre SA 30 x 50 mm nickelé 3 clés avec vis de 40 mm	00016309	10	-	-	-	-	-	-	-	-	-	-	-
Cylindre SA 35 x 45 mm nickelé 3 clés avec vis de 40 mm	00016314	10	-	-	-	-	-	-	-	-	-	-	-
Cylindre SA 40 x 50 mm nickelé 3 clés avec vis de 40 mm	00016321	10	-	-	-	-	-	-	-	-	-	-	-

⚠ Non stocké/Non-stored/Producto no estocado - 📦 Sur stock Europe Zone 1 et Zone 2, nous consulter pour délai d'approvisionnement - 📦 Epuisement/Stock depletion/Agotamiento del stock

Cylindre / 5 GOUPILLES SA ECO



NIVEAU DE SÉCURITÉ



Designation	Boite	Colis.	Prix	Sachet	Colis.	Prix	Brochable					Colis.	Prix
							France	Euro 1	Euro 2	Euro 3	Euro 4		
Cylindre SA 30 x 30 mm nickelé 3 clés avec vis de 45 mm	00016251	10	-	-	-	-	-	-	-	-	-	-	-
Cylindre SA 35 x 35 mm nickelé 3 clés avec vis de 45 mm	00016325	10	-	-	-	-	-	-	-	-	-	-	-
Cylindre SA 40 x 40 mm nickelé 3 clés avec vis de 45 mm	00016319	10	-	-	-	-	-	-	-	-	-	-	-
Cylindre SA 45 x 45 mm nickelé 3 clés avec vis de 45 mm	00016323	10	-	-	-	-	-	-	-	-	-	-	-
Cylindre SA 30 x 40 mm nickelé 3 clés avec vis de 45 mm	00016274	10	-	-	-	-	-	-	-	-	-	-	-
Cylindre SA 30 x 50 mm nickelé 3 clés avec vis de 45 mm	00016310	10	-	-	-	-	-	-	-	-	-	-	-
Cylindre SA 30 x 60 mm nickelé 3 clés avec vis de 45 mm	00016312	10	-	-	-	-	-	-	-	-	-	-	-
Cylindre SA 35 x 45 mm nickelé 3 clés avec vis de 45 mm	00016315	10	-	-	-	-	-	-	-	-	-	-	-
Cylindre SA 35 x 50 mm nickelé 3 clés avec vis de 45 mm	00016317	10	-	-	-	-	-	-	-	-	-	-	-
Cylindre SA 30 x 30 mm nickelé 3 clés avec vis de 50 mm	00016250	10	-	-	-	-	-	-	-	-	-	-	-
Cylindre SA 45 x 45 mm nickelé 3 clés avec vis de 50 mm	00016324	10	-	-	-	-	-	-	-	-	-	-	-
Cylindre SA 35 x 45 mm nickelé 3 clés avec vis de 50 mm	00016316	10	-	-	-	-	-	-	-	-	-	-	-



☐ Non stocké/Non-stored/Productos no estocados - ☑ Sur stock Europe Zone 1 et Zone 2, nous consulter pour délai d'approvisionnement - ☒ Epuement/Stock depletion/Agotamiento del stock

Cylindre / 5 GOUPILLES SA

ECO



NIVEAU DE SÉCURITÉ



GARANTIE



X 3



Protection
Arrachement

Description/Description/Descripción

Profil européen alliage. Mécanisme à 5 goupilles.
Panneton anti arrachement. 3 clés en acier nickelé.
*European alloy profile. 5 pin mechanism. Driver cam
made of powdered metal. 3 nickel plated steel keys.*
Perfil europeo de aleación. Mecanismo con 5 pasadores.

Pivote de acero sinterizado. 3 llaves de acero niquelado.

Finition/Finish/Acabado

Laitonné
Brass finish
Latonado

Designation	Boite	Colis.	Prix	Sachet	Colis.	Prix	Brochable					Colis.	Prix
							France	Euro 1	Euro 2	Euro 3	Euro 4		
Demi-cylindre SA 30 x 10 mm 3 clés laitonné	00015949	10	-	00915949	10	-	00115949	00193138 NS	00192138 NS	00194138	-	10	-
Cylindre SA 20 x 20 mm laitonné 3 clés	00016243	10	-	-	-	-	-	00193749 NS	00192749 NS	-	-	10	-
Cylindre SA 21 x 21 mm laitonné 3 clés	00016244	10	-	-	-	-	-	-	-	-	-	-	-
Cylindre SA 25 x 25 mm laitonné 3 clés	00016246	10	-	-	-	-	-	00193796 NS	00192796 NS	-	-	10	-
Cylindre SA 27 x 27 mm laitonné 3 clés	00016255	10	-	-	-	-	00116255	-	-	00194267	-	10	-
Cylindre SA 27 x 31 mm laitonné 3 clés	-	-	-	-	-	-	-	-	-	00194246	-	10	-
Cylindre SA 28 x 33 mm laitonné 3 clés	-	-	-	-	-	-	-	-	-	00194133	-	10	-
Cylindre SA 30 x 30 mm laitonné 3 clés	00016259	10	-	00916259	10	-	00116259	00193139 NS	0099213 NS	00194139	-	10	-
Jeu de 2 cylindres SA laitonné 30 x 30 mm 6 clés identiques	-	-	-	00916164	10	-	00116264	00193140 NS	00192140 NS	00194140	-	10	-
Jeu de 3 cylindres SA laitonné 30 x 30 mm 9 clés identiques	-	-	-	-	-	-	00216359	-	-	-	-	10	-
Cylindre SA 35 x 35 mm laitonné 3 clés	00016279	10	-	00916279	10	-	00116279	00193144 NS	00192144 NS	00194144	-	10	-
Cylindre SA 40 x 40 mm laitonné 3 clés	00016189	10	-	00916189	10	-	00116189	00193146 NS	00992145 NS	00194146	-	10	-
Cylindre SA 45 x 45 mm laitonné 3 clés	00016192	10	-	-	-	-	00116192	00193536 NS	00192531 NS	-	-	10	-

NS Non stocké/Non-stored/Producto no estocado - ☐ Sur stock Europe Zone 1 et Zone 2, nous consulter pour délai d'approvisionnement - ☒ Epuisement/Stock depletion/Agotamiento del stock



Designation	Boîte	Colis.	Prix	Sachet	Colis.	Prix	Brochable					Colis.	Prix
							France	Euro 1	Euro 2	Euro 3	Euro 4		
Cylindre SA 50 x 50 mm laitonné 3 clés	00016108	10	-	-	-	-	00116221	00193530 NS	00192530 NS	-	-	10	-
Cylindre SA 25 x 30 mm laitonné 3 clés	00016248	10	-	-	-	-	-	00193797 NS	00192797 NS	-	-	10	-
Cylindre SA 25 x 35 mm laitonné 3 clés	00016249	10	-	-	-	-	-	00193799 NS	00192799 NS	-	-	10	-
Cylindre SA 25 x 40 mm laitonné 3 clés	00016242	10	-	-	-	-	-	00193798 NS	00192798 NS	-	-	10	-
Cylindre SA 30 x 35 mm laitonné 3 clés	00016297	10	-	-	-	-	00116297	00193533 NS	00192533 NS	00194533	-	10	-
Cylindre SA 30 x 40 mm laitonné 3 clés	00016269	10	-	00916269	10	-	00116269	00193141 NS	00992141 NS	00194141	-	10	-
Cylindre SA 30 x 50 mm laitonné 3 clés	00016289	10	-	00916289	10	-	00116289	00193142 NS	00192142 NS	00194142	-	10	-
Cylindre SA 30 x 60 mm laitonné 3 clés	00016299	10	-	00916299	10	-	00116299	00193143 NS	00192143 NS	00194143	-	10	-
Cylindre SA 30 x 65 mm laitonné 3 clés	00016399	10	-	-	-	-	-	-	-	-	-	-	-
Cylindre SA 30 x 70 mm laitonné 3 clés	00016109	10	-	-	-	-	-	-	-	-	-	-	-
Cylindre SA 30 x 80 mm laitonné 3 clés	00016119	10	-	-	-	-	-	-	-	-	-	-	-
Cylindre SA 30 x 90 mm laitonné 3 clés	00016129	10	-	-	-	-	-	-	-	-	-	-	-
Cylindre SA 35 x 40 mm laitonné 3 clés	00016220	10	-	-	-	-	00116220	00193534 NS	00192534 NS	-	-	10	-
Cylindre SA 35 x 45 mm laitonné 3 clés	00016295	10	-	00916295	10	-	00116295	00193147 NS	00192146 NS	00194147	-	10	-
Cylindre SA 35 x 50 mm laitonné 3 clés	00016298	10	-	-	-	-	-	-	-	-	-	-	-
Cylindre SA 35 x 55 mm laitonné 3 clés	00016303	10	-	-	-	-	-	-	-	00194177	-	10	-
Cylindre SA 40 x 45 mm laitonné 3 clés	00016191	10	-	-	-	-	00116191	00193535 NS	00192535 NS	-	-	10	-
Cylindre SA 40 x 50 mm laitonné 3 clés	00016290	10	-	-	-	-	00116290	00193532 NS	00192532 NS	00194532	-	10	-
Cylindre SA à bouton 30 x 30 mm laitonné 3 clés	00014069	10	-	00914069	10	-	00114069	00193148 NS	00192147 NS	00194148	-	10	-
Cylindre SA à bouton 35 x 25 mm laitonné 3 clés	00014054	10	-	-	-	-	-	00193824 NS	00192824 NS	-	-	10	-
Cylindre SA à bouton 35 x 35 mm laitonné 3 clés	00014053	10	-	-	-	-	-	00193743 NS	00192743 NS	00194110	-	10	-
Cylindre SA à bouton 30 x 35 mm laitonné 3 clés	00014055	10	-	-	-	-	-	00193660 NS	00192660 NS	-	-	10	-
Cylindre SA à bouton 30 x 40 mm laitonné 3 clés	00014079	10	-	-	-	-	-	00193692 NS	00192692 NS	00194692	-	10	-
Cylindre SA à bouton 35 x 30 mm laitonné 3 clés	00014057	10	-	-	-	-	-	00193699 NS	00192699 NS	-	-	10	-
Cylindre SA à bouton 40 x 30 mm laitonné 3 clés	00014077	10	-	-	-	-	-	00193745 NS	00192745 NS	00194745	-	10	-
Cylindre SA à bouton 40 x 40 mm laitonné 3 clés	00014080	10	-	-	-	-	-	-	-	00194131	-	10	-
Cylindre SA à bouton 45 x 45 mm laitonné 3 clés	-	10	-	-	-	-	-	-	-	00194132	-	10	-



Cylindre / 5 GOUPILLES SA

ECO



NIVEAU DE SÉCURITÉ



GARANTIE



Protection
Arrachement



X 3

Description/Description/Descripción

Profil européen alliage. Mécanisme à 5 goupilles.
Panneton anti arrachement. 3 clés en acier nickelé.
European alloy profile. 5 pin mechanism. Driver cam
made of powdered metal. 3 nickel plated steel keys.
Perfil europeo de aleación. Mecanismo con 5 pasadores.

Pivote de acero sinterizado. 3 llaves de acero niquelado.

Finition/Finish/Acabado

Nickelé
Nickel plated
Niquelado

Designation	Boite	Colis.	Prix	Sachet	Colis.	Prix	Brochable					Colis.	Prix
							France	Euro 1	Euro 2	Euro 3	Euro 4		
Demi-cylindre SA 30 x 10 mm nickelé 3 clés	00015948	10	-	00915948	10	-	00115948	00193609 NS	00192609 NS	00194609	-	10	-
Demi-cylindre SA 40 x 10 mm nickelé 3 clés	00015950	10	-	-	-	-	-	-	-	-	-	-	-
Cylindre SA 21 x 21 mm nickelé 3 clés	00016245	10	-	-	-	-	-	-	-	-	-	-	-
Cylindre SA 25 x 25 mm nickelé 3 clés	00016247	10	-	-	-	-	-	-	-	-	-	-	-
Cylindre SA 27 x 27 mm nickelé 3 clés	00016256	10	-	-	-	-	00116256	-	-	00194268	-	10	-
Cylindre SA 27 x 43 mm nickelé 3 clés	00016223	10	-	-	-	-	-	-	-	-	-	-	-
Cylindre SA 28 x 33 mm nickelé 3 clés	-	-	-	-	-	-	-	-	-	00194176	-	10	-
Cylindre SA 30 x 30 mm nickelé 3 clés	00016258	10	-	00916258	10	-	00116258	00193269 NS	00192269 NS	00194269	-	10	-
Lot de 2 cylindres SA 30 x 30 mm nickelé 6 clés identiques	-	-	-	-	-	-	-	00193604 NS	00192604 NS	00194604	-	10	-
Cylindre SA 35 x 35 mm nickelé 3 clés	00016278	10	-	00916278	10	-	00116278	00193612 NS	00192612 NS	00194612	-	10	-
Cylindre SA 40 x 40 mm nickelé 3 clés	00016190	10	-	00916190	10	-	00116190	00193613 NS	00192613 NS	00194613	-	10	-
Cylindre SA 45 x 45 mm nickelé 3 clés	00016395	10	-	-	-	-	00116395	00193617 NS	00192617 NS	00194617	-	10	-
Cylindre SA 50 x 50 mm nickelé 3 clés	00016231	10	-	-	-	-	-	00193616 NS	00192616 NS	00194616	-	10	-
Cylindre SA 25 x 30 mm nickelé 3 clés	00016222	10	-	-	-	-	-	00193747 NS	00192747 NS	-	-	10	-
Cylindre SA 25 x 35 mm nickelé 3 clés	00016239	10	-	-	-	-	-	-	-	-	-	-	-
Cylindre SA 25 x 40 mm nickelé 3 clés	00016232	10	-	-	-	-	-	00193748 NS	00192748 NS	-	-	10	-

NS Non stocké/Non-stored/Producto no estocado - ☐ Sur stock Europe Zone 1 et Zone 2, nous consulter pour délai d'approvisionnement - ☒ Epuisement/Stock depletion/Agotamiento del stock

Designation	Boite	Colis.	Prix	Sachet	Colis.	Prix	Brochable					Colis.	Prix
							France	Euro 1	Euro 2	Euro 3	Euro 4		
Cylindre SA 27 x 32 mm nickelé 3 clés	00016257	10	-	-	-	-	-	-	-	-	-	-	-
Cylindre SA 30 x 35 mm nickelé 3 clés	00016273	10	-	-	-	-	00116273	-	00192602 NS	00194602	-	10	-
Cylindre SA 30 x 40 mm nickelé 3 clés	00016268	10	-	00916268	10	-	00116268	00193270 NS	00192270 NS	00194270	-	10	-
Cylindre SA 30 x 50 mm nickelé 3 clés	00016286	10	-	00916286	10	-	00116286	00193610 NS	00192610 NS	00194610	-	10	-
Cylindre SA 30 x 55 mm nickelé 3 clés	00016355	10	-	-	-	-	-	-	-	-	-	-	-
Cylindre SA 30 x 60 mm nickelé 3 clés	00016391	10	-	00916391	10	-	00116391	00193611 NS	00192611 NS	00194611	-	10	-
Cylindre SA 30 x 65 mm nickelé 3 clés	00016394	10	-	-	-	-	-	-	-	-	-	-	-
Cylindre SA 30 x 70 mm nickelé 3 clés	00016371	10	-	-	-	-	-	-	-	-	-	-	-
Cylindre SA 30 x 80 mm nickelé 3 clés	00016380	10	-	-	-	-	-	-	-	-	-	-	-
Cylindre SA 35 x 40 mm nickelé 3 clés	00016354	10	-	-	-	-	-	-	-	-	-	-	-
Cylindre SA 35 x 45 mm nickelé 3 clés	00016296	10	-	00916296	10	-	00116296	00193614 NS	00192614 NS	00194614	-	10	-
Cylindre SA 35 x 50 mm nickelé 3 clés	00016396	10	-	00916396	10	-	-	-	-	-	-	-	-
Cylindre SA 35 x 55 mm nickelé 3 clés	00016313	10	-	-	-	-	-	-	-	-	-	-	-
Cylindre SA 40 x 45 mm nickelé 3 clés	00016397	10	-	00916397	10	-	-	-	-	-	-	-	-
Cylindre SA 40 x 50 mm nickelé 3 clés	00016398	10	-	-	-	-	00116398	00193618 NS	00192618 NS	00194618	-	10	-
Cylindre SA 40 x 55 mm nickelé 3 clés	00016074	10	-	-	-	-	-	-	-	-	-	-	-
Cylindre SA 45 x 50 mm nickelé 3 clés	00016455	10	-	-	-	-	-	-	-	-	-	-	-
Cylindre SA 45 x 55 mm nickelé 3 clés	00016457	10	-	-	-	-	-	-	-	-	-	-	-
Cylindre SA 45 x 60 mm nickelé 3 clés	00016460	10	-	-	-	-	-	-	-	-	-	-	-
Cylindre SA à bouton 30 x 30 mm nickelé 3 clés	00014068	10	-	00914068	10	-	00114068	00193615 NS	00192615 NS	00194615	-	10	-
Cylindre SA à bouton 35 x 25 mm nickelé 3 clés	00014064	10	-	-	-	-	-	00193841 NS	00192841 NS	-	-	10	-
Cylindre SA à bouton 35 x 35 mm nickelé 3 clés	00014063	10	-	-	-	-	-	00193744 NS	00192744 NS	-	-	10	-
Cylindre SA à bouton 40 x 40 mm nickelé 3 clés	00014081	10	-	-	-	-	-	-	-	-	-	-	-
Cylindre SA à bouton 30 x 35 mm nickelé 3 clés	00014065	10	-	-	-	-	-	00193691 NS	00192691 NS	-	-	10	-
Cylindre SA à bouton 30 x 40 mm nickelé 3 clés	00014078	10	-	-	-	-	-	00193693 NS	00192693 NS	-	-	10	-
Cylindre SA à bouton 30 x 50 mm nickelé 3 clés	00014082	10	-	-	-	-	-	-	-	-	-	-	-
Cylindre SA à bouton 35 x 30 mm nickelé 3 clés	00014067	10	-	-	-	-	-	00193742 NS	00192742 NS	-	-	10	-
Cylindre SA à bouton 40 x 30 mm nickelé 3 clés	00014076	10	-	-	-	-	-	00193746 NS	00192746 NS	-	-	10	-
Cylindre SA à bouton 40 x 50 mm nickelé 3 clés	00014090	10	-	-	-	-	-	-	-	-	-	-	-
Cylindre SA à bouton 50 x 40 mm nickelé 3 clés	00014091	10	-	-	-	-	-	-	-	-	-	-	-



Cylindre de sûreté / 5 GOUPILLES STD

PROTECT



NIVEAU DE SÉCURITÉ



GARANTIE



X 3



Cylindre conforme à la norme

EN 1303:2015

Classification

16000C20



Protection
Arrachement



Description/Description/Descripción

Profil européen laiton. Mécanisme à 5 goupilles.
Panneton anti arrachement. 3 clés nickelées.
European brass profile. 5 pin mechanism. Driver cam
made of powdered metal. 3 nickel plated keys.
Perfil europeo latón. Mecanismo de 5 pasadores. Pivote
de acero sinterizado. 3 llaves niqueladas

Finition/Finish/Acabado

Laiton
Brass
Latón

Version/Option/Versión

Demi-cylindre 1 entrée. Cylindre 1 entrée à bouton.
Panneton réduit.
1/2 cylinder with key way. Cylinder with key way and
inside knob.
Semicilindro. Cilindro de 2 entradas. Cilindro 1 entrada
de botón.

Designation	Boite	Colis.	Prix	Sachet	Colis.	Prix	Brochable					Colis.	Prix
							France	Euro 1	Euro 2	Euro 3	Euro 4		
Demi-cylindre STD 30 x 10 mm laiton 3 clés	00015940	10	-	00915940	10	-	00215940	00193330	00192330	00194330	-	10	-
Demi-cylindre STD 40 x 10 mm laiton 3 clés	00015944	10	-	-	-	-	-	-	-	-	-	-	-
Cylindre STD 20 x 20 mm laiton 3 clés	00016410	10	-	-	-	-	-	-	-	-	-	-	-
Cylindre STD 21 x 21 mm laiton 3 clés	00016411	10	-	-	-	-	-	-	-	-	-	-	-
Cylindre STD 25 x 25 mm laiton 3 clés	00016412	10	-	-	-	-	-	00193331	00192331	-	-	10	-
Cylindre STD 27 x 27 mm laiton 3 clés	00016413	10	-	-	-	-	00216413	-	-	00194333	-	10	-
Cylindre STD 30 x 30 mm laiton 3 clés	00016260	10	-	00916260	10	-	00216260	00193190	00192190	00194190	-	10	-
Cylindre STD 35 x 35 mm laiton 3 clés	00016370	10	-	00916270	10	-	00216270	00193192	00192192	00194192	-	10	-
Cylindre STD 40 x 40 mm laiton 3 clés	00016280	10	-	00916280	10	-	00216280	00193193	00192193	00194193	-	10	-
Cylindre STD 45 x 45 mm laiton 3 clés	00016414	10	-	-	-	-	00216414	00193336	00192336	-	-	10	-
Cylindre STD 50 x 50 mm laiton 3 clés	00016367	10	-	-	-	-	00216415	00193337	00192337	-	-	10	-
Cylindre STD 25 x 30 mm laiton 3 clés	00016416	10	-	-	-	-	-	00193338	00192338	-	-	10	-

⚠ Non stocké/Non-stored/Producto no estocado - 📦 Sur stock Europe Zone 1 et Zone 2, nous consulter pour délai d'approvisionnement - 📦 Epuisement/Stock depletion/Agotamiento del stock

Cylindre de sûreté / 5 GOUPILLES STD

PROTECT



NIVEAU DE SÉCURITÉ



013087
Panneton UNI



Designation	Boite	Colis.	Prix	Sachet	Colis.	Prix	Brochable					Colis.	Prix
							France	Euro 1	Euro 2	Euro 3	Euro 4		
Cylindre STD 25 x 35 mm laiton 3 clés	00016417	10	-	-	-	-	-	00193339	00192339	-	-	10	-
Cylindre STD 25 x 40 mm laiton 3 clés	00016418	10	-	-	-	-	-	00193340	00192340	-	-	10	-
Cylindre STD 27 x 31 mm laiton 3 clés	-	-	-	-	-	-	-	-	-	00194334	-	10	-
Cylindre STD 28 x 33 mm laiton 3 clés	-	-	-	-	-	-	-	-	-	00194335	-	10	-
Cylindre STD 30 x 35 mm laiton 3 clés	00016361	10	-	-	-	-	00216361	00193341	00192341	00194341	-	10	-
Cylindre STD 30 x 40 mm laiton 3 clés	00016265	10	-	00916265	10	-	00216265	00193191	00192191	00194191	-	10	-
Cylindre STD 30 x 45 mm laiton 3 clés	00016245	10	-	-	-	-	-	-	-	-	-	-	-
Cylindre STD 30 x 50 mm laiton 3 clés	00016281	10	-	00916281	10	-	00216281	00193195	00192195	00194195	-	10	-
Cylindre STD 30 x 60 mm laiton 3 clés	00016287	10	-	00916287	10	-	00216287	00193196	00192196	00194196	-	10	-
Cylindre STD 30 x 65 mm laiton 3 clés	00016420	10	-	-	-	-	-	-	-	-	-	-	-
Cylindre STD 30 x 70 mm laiton 3 clés	00016363	10	-	-	-	-	-	-	-	-	-	-	-
Cylindre STD 30 x 80 mm laiton 3 clés	00016364	10	-	-	-	-	-	-	-	-	-	-	-
Cylindre STD 30 x 90 mm laiton 3 clés	00016365	10	-	-	-	-	-	-	-	-	-	-	-
Cylindre STD 35 x 40 mm laiton 3 clés	00016421	10	-	-	-	-	00216421	00193342	00192342	-	-	10	-
Cylindre STD 35 x 45 mm laiton 3 clés	00016292	10	-	00916292	10	-	00216292	00193343	00192343	00194343	-	10	-
Cylindre STD 35 x 50 mm laiton 3 clés	00016422	10	-	-	-	-	-	-	-	-	-	10	-
Cylindre STD 35 x 55 mm laiton 3 clés	00016423	10	-	-	-	-	-	-	-	00194344	-	10	-
Cylindre STD 35 x 60 mm laiton 3 clés	00016224	10	-	-	-	-	-	-	-	-	-	-	-
Cylindre STD 40x 45 mm laiton 3 clés	00016424	10	-	-	-	-	00216424	00193345	00192345	-	-	10	-
Cylindre STD 40 x 50 mm laiton 3 clés	00016293	10	-	00916293	10	-	00216293	00193346	00192346	00194346	-	10	-
Cylindre STD 45x 60 mm laiton 3 clés	00016227	10	-	-	-	-	-	-	-	-	-	-	-
Cylindre STD 45x 65 mm laiton 3 clés	00016228	10	-	-	-	-	-	-	-	-	-	-	-
Cylindre STD 50x 60 mm laiton 3 clés	00016229	10	-	-	-	-	-	-	-	-	-	-	-
Cylindre STD à bouton 30 x 30 mm laiton 3 clés	00014060	10	-	00914060	10	-	00214060	00193194	00192194	00194194	-	10	-
Cylindre STD à bouton 35 x 35 mm laiton 3 clés	00014048	10	-	-	-	-	-	00193348	00192348	00194348	-	10	-

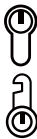

Cylindre de sûreté / 5 GOUPILLES STD

PROTECT



NIVEAU DE SÉCURITÉ



Designation	Boite	Colis.	Prix	Sachet	Colis.	Prix	Brochable					Colis.	Prix
							France	Euro 1	Euro 2	Euro 3	Euro 4		
Cylindre STD à bouton 40 x 40 mm laiton 3 clés	00014074	10	-	00914074	10	-	00214074	-	-	-	-	10	-
Cylindre STD à bouton 45 x 45 mm laiton 3 clés	-	-	-	-	-	-	-	-	-	00194358	-	10	-
Cylindre STD à bouton 30 x 35 mm laiton 3 clés	-	-	-	-	-	-	-	00193349	00192349	-	-	10	-
Cylindre STD à bouton 30 x 40 mm laiton 3 clés	00014072	10	-	00914072	10	-	00214072	00193352	00192352	00194352	-	10	-
Cylindre STD à bouton 30 x 50 mm laiton 3 clés	00014066	10	-	-	-	-	-	-	-	-	-	-	-
Cylindre STD à bouton 30 x 60 mm laiton 3 clés	00014030	10	-	-	-	-	-	-	-	-	-	-	-
Cylindre STD à bouton 35 x 25 mm laiton 3 clés	00014047	10	-	-	-	-	-	00193347	00192347	-	-	10	-
Cylindre STD à bouton 35 x 30 mm laiton 3 clés	00014049	10	-	-	-	-	-	00193353	00192353	-	-	10	-
Cylindre STD à bouton 40 x 30 mm laiton 3 clés	00014073	10	-	00914073	10	-	00214073	00193355	00192355	00194355	-	10	-
Cylindre STD à bouton 40BT x 50 mm laiton 3 clés	00014031	10	-	-	-	-	-	-	-	-	-	-	-
Cylindre STD à bouton 45BT x 45 mm laiton 3 clés	00014033	10	-	-	-	-	-	-	-	-	-	-	-
Cylindre STD à bouton 55BT x 45 mm laiton 3 clés	00014032	10	-	-	-	-	-	-	-	-	-	-	-
Lot de 2 cylindres STD 30 x 30 mm et 1 demi-cylindre STD 30 x 10 mm s'entrouvrant 9 clés	-	-	-	-	-	-	00260300	-	-	-	-	10	-
Lot de 2 cylindres STD 30 x 30 mm laiton s'entrouvrant 6 clés	-	-	-	00916263	10	-	00216263	00293157	00292157	00294157	-	10	-
Lot de 3 cylindres STD 30 x 30 mm laiton s'entrouvrant 9 clés	-	-	-	00916264	10	-	00216264	00293159	00292159	00294159	-	10	-

NS Non stocké/Non-stored/Producto no estocado - ☐ Sur stock Europe Zone 1 et Zone 2, nous consulter pour délai d'approvisionnement - ☒ Epuisement/Stock depletion/Agotamiento del stock

Cylindre de sûreté / 5 GOUPILLES STD

PROTECT



NIVEAU DE SÉCURITÉ



GARANTIE



X 3



Cylindre conforme à la norme

EN 1303:2015

Classification

1 6 0 0 0 C 2 0



Protection
Arrachement

Description/Description/Descripción

Profil européen laiton. Mécanisme à 5 goupilles.

Panneton anti arrachement. 3 clés nickelées.

European brass profile. 5 pin mechanism. Driver cam made of powdered metal. 3 nickel plated keys.

Perfil europeo latón. Mecanismo de 5 pasadores. Pivote de acero sinterizado. 3 llaves niqueladas

Finition/Finish/Acabado

Nickelé / Nickel plated / Niquelado

Version/Option/Versión

Demi-cylindre 1 entrée. Cylindre 1 entrée à bouton.

Panneton réduit.

1/2 cylinder with key way. Cylinder with key way and inside knob.

Semicilindro. Cilindro de 2 entradas. Cilindro 1 entrada de botón.

Designation	Boite	Colis.	Prix	Sachet	Colis.	Prix	Brochable					Colis.	Prix
							France	Euro 1	Euro 2	Euro 3	Euro 4		
Demi-cylindre STD 30 x 10 mm nickelé 3 clés	00015941	10	-	00915941	10	-	00215941	00193149	00192149	00194149	-	10	-
Demi-cylindre STD 40 x 10 mm nickelé 3 clés	00015942	10	-	-	-	-	-	-	-	-	-	-	-
Cylindre STD 21 x 21 mm nickelé 3 clés	00016430	10	-	-	-	-	-	-	-	-	-	-	-
Cylindre STD 25 x 25 mm nickelé 3 clés	00016431	10	-	-	-	-	-	-	-	-	-	-	-
Cylindre STD 27 x 27 mm nickelé 3 clés	00016432	10	-	-	-	-	-	-	-	-	-	-	-
Cylindre STD 30 x 30 mm nickelé 3 clés	00016261	10	-	00916261	10	-	00216261	00193150 NS	00192149 E NS	00194150	-	10	-
Cylindre STD 35 x 35 mm nickelé 3 clés	00016271	10	-	00916271	10	-	00216271	00193154 NS	00192153	00194154	-	10	-
Cylindre STD 40 x 40 mm nickelé 3 clés	00016283	10	-	00916283	10	-	00216283	00193157 NS	- E NS	00194157	-	10	-
Cylindre STD 45 x 45 mm nickelé 3 clés	00016378	10	-	-	-	-	00216378	00193362 NS	00192362	00194362	-	10	-
Cylindre STD 50 x 50 mm nickelé 3 clés	00016379	10	-	-	-	-	-	00193363 NS	00192363	00194363	-	10	-
Cylindre STD 25 x 30 mm nickelé 3 clés	00016433	10	-	-	-	-	-	00193364	00192364	-	-	10	-
Cylindre STD 25 x 35 mm nickelé 3 clés	00016434	10	-	-	-	-	-	-	-	-	-	-	-
Cylindre STD 25 x 40 mm nickelé 3 clés	00016435	10	-	-	-	-	-	00193365	00192365	-	-	10	-
Cylindre STD 27 x 32 mm nickelé 3 clés	00016436	10	-	-	-	-	-	-	-	-	-	-	-
Cylindre STD 28 x 33 mm nickelé 3 clés	-	-	-	-	-	-	-	-	00194361	-	-	10	-

NS Non stocké/Non-stored/Producto no estocado - Sur stock Europe Zone 1 et Zone 2, nous consulter pour délai d'approvisionnement - E Epuisement/Stock depletion/Agotamiento del stock



Cylindre de sûreté / 5 GOUPILLES STD

PROTECT



NIVEAU DE SÉCURITÉ



016272
avec panneton réduit



Designation	Boite	Colis.	Prix	Sachet	Colis.	Prix	Brochable					Colis.	Prix
							France	Euro 1	Euro 2	Euro 3	Euro 4		
Cylindre STD 30 x 35 mm nickelé 3 clés	00016368	10	-	-	-	-	0216368	-	-	00194366	-	10	-
Cylindre STD 30 x 40 mm nickelé 3 clés	00016266	10	-	00916266	10	-	00216266	00193151 NS	00192151	00194151	-	10	-
Cylindre STD 30 x 45 mm nickelé 3 clés	00016240	10	-	-	-	-	-	-	-	-	-	-	-
Cylindre STD 30 x 50 mm nickelé 3 clés	00016282	10	-	00916282	10	-	00216282	00193152 NS	00192152	00194152	-	10	-
Cylindre STD 30 x 55 mm nickelé 3 clés	00016437	10	-	-	-	-	-	-	-	-	-	-	-
Cylindre STD 30 x 60 mm nickelé 3 clés	00016288	10	-	00916288	10	-	00216288	00193153	00192152	00194153	-	10	-
Cylindre STD 30 x 65 mm nickelé 3 clés	00016438	10	-	-	-	-	-	-	-	-	-	-	-
Cylindre STD 30 x 70 mm nickelé 3 clés	00016369	10	-	-	-	-	-	-	-	-	-	-	-
Cylindre STD 30 x 80 mm nickelé 3 clés	00016374	10	-	-	-	-	-	-	-	-	-	-	-
Cylindre STD 30 x 90 mm nickelé 3 clés	00016375	10	-	-	-	-	-	-	-	-	-	-	-
Cylindre STD 35 x 40 mm nickelé 3 clés	00016275	10	-	00916275	10	-	00216275	-	-	-	-	10	-
Cylindre STD 35 x 45 mm nickelé 3 clés	00016294	10	-	00916294	10	-	00216294	00193156	00192154	00194156	-	10	-
Cylindre STD 35 x 50 mm nickelé 3 clés	00016376	10	-	00916376	10	-	-	-	-	-	-	-	-
Cylindre STD 35 x 55 mm nickelé 3 clés	00016285	10	-	00916285	10	-	00216285	-	-	-	-	10	-
Cylindre STD 35 x 60 mm nickelé 3 clés	00016253	10	-	-	-	-	-	-	-	-	-	-	-
Cylindre STD 35 x 65 mm nickelé 3 clés	00016254	10	-	-	-	-	-	-	-	-	-	-	-
Cylindre STD 35 x 75 mm nickelé 3 clés	00016262	10	-	-	-	-	-	-	-	-	-	-	-
Cylindre STD 40 x 45 mm nickelé 3 clés	00016234	10	-	00916234	10	-	00216234	-	-	-	-	10	-
Cylindre STD 40 x 50 mm nickelé 3 clés	00016291	10	-	00916291	10	-	00216291	00193367	00192367	00194367	-	10	-
Cylindre STD 40 x 55 mm nickelé 3 clés	00016263	10	-	-	-	-	-	-	-	-	-	-	-
Cylindre STD 40 x 60 mm nickelé 3 clés	00016377	10	-	-	-	-	00216377	-	-	-	-	10	-
Cylindre STD 45 x 50 mm nickelé 3 clés	00016241	10	-	-	-	-	00216241	-	-	-	-	10	-

NS Non stocké/Non-stored/Producto no estocado - S Sur stock Europe Zone 1 et Zone 2, nous consulter pour délai d'approvisionnement - E Epuisement/Stock depletion/Agotamiento del stock

Cylindre de sûreté / 5 GOUPILLES STD

PROTECT



NIVEAU DE SÉCURITÉ



Designation	Boite	Colis.	Prix	Sachet	Colis.	Prix	Brochable					Colis.	Prix
							France	Euro 1	Euro 2	Euro 3	Euro 4		
Cylindre STD 45 x 55 mm nickelé 3 clés	00016235	10	-	00916235	10	-	00216235	-	-	-	-	10	-
Cylindre STD 45 x 60 mm nickelé 3 clés	00016439	10	-	-	-	-	-	-	-	-	-	-	-
Cylindre STD à bouton 30 x 30 mm nickelé 3 clés	00014061	10	-	00914061	10	-	00214061	00193158 NS	00192156	00194158	-	10	-
Cylindre STD à bouton 30 x 35 mm nickelé 3 clés	00014036	10	-	-	-	-	-	00193370 NS	00192370	-	-	10	-
Cylindre STD à bouton 30 x 40 mm nickelé 3 clés	00016236	10	-	00916236	10	-	00216236	00193371 NS	00192371	-	-	10	-
Cylindre STD à bouton 30 x 50 mm nickelé 3 clés	00014070	10	-	-	-	-	-	-	-	-	-	-	-
Cylindre STD à bouton 35 x 25 mm nickelé 3 clés	00014034	10	-	-	-	-	-	00193368	00192368	-	-	10	-
Cylindre STD à bouton 35 x 30 mm nickelé 3 clés	00014037	10	-	-	-	-	-	00193372	00194372	-	-	10	-
Cylindre STD à bouton 35 x 35 mm nickelé 3 clés	00014035	10	-	-	-	-	-	00193369	00192369	-	-	10	-
Cylindre STD à bouton 40 x 30 mm nickelé 3 clés	00016237	10	-	00916237	10	-	00216237	00193373	00192373	-	-	10	-
Cylindre STD à bouton 40 x 40 mm nickelé 3 clés	00016238	10	-	00916238	10	-	00216238	-	-	-	-	10	-
Cylindre STD à bouton 40 x 50 mm nickelé 3 clés	00014038	10	-	-	-	-	-	-	-	-	-	-	-
Cylindre STD à bouton 50 x 40 mm nickelé 3 clés	00014039	10	-	-	-	-	-	-	-	-	-	-	-
Cylindre STD 30 x 10 mm nickelé panneton ESP 3 clés	00094725	10	-	-	-	-	-	-	-	00194725	-	10	-
Cylindre STD 30 x 30 mm nickelé panneton réduit 3 clés pour réf. 011721-011728-012825	00016272	10	-	00916272	10	-	00216272	-	-	00194272	-	10	-
Cylindre STD 30 x 40 mm nickelé panneton ESP 3 clés	00094727	10	-	-	-	-	-	-	-	00194727	-	10	-
Cylindre STD 30 x 50 mm nickelé panneton ESP 3 clés	00094728	10	-	-	-	-	-	-	-	00194728	-	10	-
Lot de 2 cylindres STD 30 x 30 mm nickelé s'ouvrant 6 clés	-	-	-	-	-	-	00216262	00293158	00292158 NS	00294158	-	10	-
Lot de 3 Cylindres STD 30 x 30 mm nickelé s'ouvrant 9 clés	-	-	-	-	-	-	00216362	-	00292160 NS	00294160	-	10	-
Cylindre STD 30 x 30 mm nickelé panneton ESP 3 clés	00094726	10	-	-	-	-	-	-	-	-	-	-	-



NS Non stocké/Non-stored/Productos no estocado - Sur stock Europe Zone 1 et Zone 2, nous consulter pour délai d'approvisionnement - E Epuement/Stock depletion/Agotamiento del stock

Cylindre de sûreté / 5G STD URGENCE

PROTECT

Ouverture possible de l'extérieur même si une clé est restée à l'intérieur.



Protection Arrachement



Protection Perçage



NIVEAU DE SÉCURITÉ



GARANTIE



X 3

Description/Description/Descripción

Profil européen laiton. Mécanisme à 5 goupilles. Protection contre le perçage par aiguille en acier trempé aux 2 entrées. Panneton anti arrachement. 3 clés acier nickelé. Fonction urgence : panneton débrayable, ouverture possible de l'extérieur même si une clé est restée à l'intérieur.

European brass profile. 5 pin mechanism. Anti-drilling protection hardened steel pins at the 2 key ways. Driver cam made of powdered metal. 3 nickel plated steel keys. Emergency function : the cylinder can work even if a key is inserted on the inner side of the door.

Perfil europeo latón. Mecanismo de 5 pasadores. Protección contra el taladrado aguja de acero templado en las 2 entradas. Pivote de acero sinterizado. Función de emergencia : se puede introducir una llave en el cilindro y girar el pivote incluso si ya hay una llave introducida. 3 llaves de acero niquelado.

Finition/Finish/Acabado

Laiton ou nickelé
Brass or nickel plated
Latón o niquelado

Version/Option/Versión

Cylindre 1 entrée à bouton
Cylinder with key way and inside knob.
Cilindro antitaladrado 1 entrada de botón

Designation	Boite	Colis.	Prix	Sachet	Colis.	Prix	Brochable					Colis.	Prix
							France	Euro 1	Euro 2	Euro 3	Euro 4		
Cylindre STD Urgence laiton panneton débrayable 35 x 35 mm 3 clés	00015260	10	-	00915260	20	-	00215260	-	-	-	-	5	-
Cylindre STD Urgence laiton panneton débrayable 35 x 40 mm 3 clés	-	-	-	00915265	20	-	00215265	-	-	-	-	5	-
Cylindre STD Urgence laiton à bouton 30 x 30 mm 3 clés	-	-	-	00913460	20	-	00213460	-	-	-	-	5	-
Cylindre STD Urgence nickelé panneton débrayable 35 x 35 mm 3 clés	-	-	-	00915261	20	-	00215261	-	-	-	-	5	-
Cylindre STD Urgence nickelé panneton débrayable 35 x 40 mm 3 clés	-	-	-	00915266	20	-	00215266	-	-	-	-	5	-
Cylindre STD Urgence nickelé à bouton 30 x 30 mm 3 clés	-	-	-	00913461	20	-	00213461	-	-	-	-	5	-

⚠ Non stocké/Non-stored/Producto no estocado - 📦 Sur stock Europe Zone 1 et Zone 2, nous consulter pour délai d'approvisionnement - 📦 Epuisement/Stock depletion/Agotamiento del stock

Cylindre de sûreté / 5G STD MODIFIABLE

PROTECT



NIVEAU DE SÉCURITÉ



GARANTIE



X 2x3

En introduisant une clé du second jeu, les clés du premier jeu deviennent inutilisables.



Protection Arrachement



Protection Perçage

Description/Description/Descripción

Profil européen laiton. Mécanisme à 5 goupilles. Protection contre le perçage par aiguille en acier trempé aux 2 entrées. Panneton anti arrachement. 2 x 3 clés. Fonction modifiable: modification de la combinaison, en cas de perte de clés du premier jeu, introduire 1 clé du second jeu dans le cylindre. = les clés du premier jeu deviennent inutilisables.

European brass profile. 5 pin mechanism. Anti-drilling protection hardened steel pins at the 2 key ways. Driver cam made of powdered metal. 2 x 3 keys. Change of combination : in case of loosing keys of the first set, introduce a key of the second set = all keys of the first combination can't be used.

Perfil europeo de latón. Mecanismo de 5 pasadores. Protección contra el taladrado aguja de acero templado en las 2 entradas. Pivote de acero sinterizado. 2 x 3 llaves. Modificación de la combinación, en caso de pérdida de las llaves del primer juego, introducir una llave del segundo juego en el cilindro = las llaves del primer juego son inutilizables

Finition/Finish/Acabado

Laiton ou nickelé
Brass or nickel plated
Latón o niquelado

Version/Option/Versión

Cylindre 1 entrée à bouton
Cylinder with key way and inside knob
Cilindro entrada de botón

Utilisation/Use/Utilización

Sécurité en cas de perte de clés
Security in case of loosing keys
Seguridad en caso de pérdida de llaves

Designation	Boite	Colis.	Prix	Sachet	Colis.	Prix	Brochable					Colis.	Prix
							France	Euro 1	Euro 2	Euro 3	Euro 4		
Cylindre STD modifiable 30 x 30 mm laiton 2 x 3 clés	-	-	-	-	-	-	00214260	-	-	-	-	5	-
Cylindre STD modifiable 30 x 40 mm laiton 2 x 3 clés	-	-	-	-	-	-	00214265	-	-	-	-	5	-
Cylindre STD modifiable à bouton 30 x 30 mm laiton 2 x 3 clés	-	-	-	-	-	-	00212460	-	-	-	-	5	-
Cylindre STD modifiable 30 x 30 mm nickelé 2 x 3 clés	-	-	-	-	-	-	00214261	-	-	-	-	5	-
Cylindre STD modifiable 30 x 40 mm nickelé 2 x 3 clés	-	-	-	-	-	-	00214266	-	-	-	-	5	-
Cylindre STD modifiable à bouton 30 x 30 mm nickelé 2 x 3 clés	-	-	-	-	-	-	00212461	-	-	-	-	5	-

Non stocké/Non-stored/Producto no estocado - Sur stock Europe Zone 1 et Zone 2, nous consulter pour délai d'approvisionnement - Epuement/Stock depletion/Agotamiento del stock



Cylindre de sûreté / HG 5

PROTECT

Système à multi-profil
pour la réalisation
d'organigramme.



Protection
Arrachement

Description/Description/Descripción

Profil européen. Mécanisme à 5 goupilles en maillechort.
Panneton anti arrachement. 3 clés en acier nickelé.
(laiton pour organigramme).

European profile. 5 pin mechanism. Driver cam made of powdered metal. 3 nickel plated steel keys. (brass for master keying system).

Perfil europeo. Mecanismo de 5 pasadores de alpaca
Pivote de acero sinterizado. 3 llaves de acero niquelado.
(latón en organigrama).

Finition/Finish/Acabado

Laiton ou nickelé / Brass or nickel plated
Latón o niquelado



NIVEAU DE SÉCURITÉ



GARANTIE



X 3

Version/Option/Versión

Possibilité de montage avec panneton débrayable
Point Service disponible.

Emergency function on request.

Posibilidad de montaje con sistema de emergencia.

Utilisation/Use/Utilización

Système organigramme.

Master keying system.

Sistema con organigrama.

Designation	Boite	Colis.	Prix	Sachet	Colis.	Prix	Brochable					Colis.	Prix
							France	Euro 1	Euro 2	Euro 3	Euro 4		
Cylindre HG5 30 x 10 mm laiton 3 clés	00053010	10	-	-	-	-	-	-	-	-	-	-	-
Cylindre HG5 35 x 10 mm laiton 3 clés	00053510 NS	10	-	-	-	-	-	-	-	-	-	-	-
Cylindre HG5 40 x 10 mm laiton 3 clés	00054010 NS	10	-	-	-	-	-	-	-	-	-	-	-
Cylindre HG5 45 x 10 mm laiton 3 clés	00054510 NS	10	-	-	-	-	-	-	-	-	-	-	-
Cylindre HG5 50 x 10 mm laiton 3 clés	00055010 NS	10	-	-	-	-	-	-	-	-	-	-	-
Cylindre HG5 55 x 10 mm laiton 3 clés	00055510 NS	10	-	-	-	-	-	-	-	-	-	-	-
Cylindre HG5 60 x 10 mm laiton 3 clés	00056014 NS	10	-	-	-	-	-	-	-	-	-	-	-
Cylindre HG5 70 x 10 mm laiton 3 clés	00057010 NS	10	-	-	-	-	-	-	-	-	-	-	-
Cylindre HG5 80 x 10 mm laiton 3 clés	00058010 NS	10	-	-	-	-	-	-	-	-	-	-	-
Cylindre HG5 90 x 10 mm laiton 3 clés	00059019 NS	10	-	-	-	-	-	-	-	-	-	-	-

NS Non stocké/Non-stored/Producto no estocado - ☐ Sur stock Europe Zone 1 et Zone 2, nous consulter pour délai d'approvisionnement - ☒ Epuisement/Stock depletion/Agotamiento del stock

Designation	Boite	Colis.	Prix	Sachet	Colis.	Prix	Brochable					Colis.	Prix
							France	Euro 1	Euro 2	Euro 3	Euro 4		
Cylindre HG5 30 x 30 mm laiton 3 clés	00053030	10	-	-	-	-	-	-	-	-	-	-	-
Cylindre HG5 35 x 35 mm laiton 3 clés	00053535 <small>NS</small>	10	-	-	-	-	-	-	-	-	-	-	-
Cylindre HG5 40 x 40 mm laiton 3 clés	00054040 <small>NS</small>	10	-	-	-	-	-	-	-	-	-	-	-
Cylindre HG5 45 x 45 mm laiton 3 clés	00054545 <small>NS</small>	10	-	-	-	-	-	-	-	-	-	-	-
Cylindre HG5 50 x 50 mm laiton 3 clés	00055050 <small>NS</small>	10	-	-	-	-	-	-	-	-	-	-	-
Cylindre HG5 55 x 55 mm laiton 3 clés	00055555 <small>NS</small>	10	-	-	-	-	-	-	-	-	-	-	-
Cylindre HG5 60 x 60 mm laiton 3 clés	00056060 <small>NS</small>	10	-	-	-	-	-	-	-	-	-	-	-
Cylindre HG5 30 x 35 mm laiton 3 clés	00053035 <small>NS</small>	10	-	-	-	-	-	-	-	-	-	-	-
Cylindre HG5 30 x 40 mm laiton 3 clés	00053040 <small>NS</small>	10	-	-	-	-	-	-	-	-	-	-	-
Cylindre HG5 30 x 45 mm laiton 3 clés	00053045 <small>NS</small>	10	-	-	-	-	-	-	-	-	-	-	-
Cylindre HG5 30 x 50 mm laiton 3 clés	00053050 <small>NS</small>	10	-	-	-	-	-	-	-	-	-	-	-
Cylindre HG5 30 x 55 mm laiton 3 clés	00053055 <small>NS</small>	10	-	-	-	-	-	-	-	-	-	-	-
Cylindre HG5 30 x 60 mm laiton 3 clés	00053060 <small>NS</small>	10	-	-	-	-	-	-	-	-	-	-	-
Cylindre HG5 30 x 65 mm laiton 3 clés	00053065 <small>NS</small>	10	-	-	-	-	-	-	-	-	-	-	-
Cylindre HG5 30 x 70 mm laiton 3 clés	00053070 <small>NS</small>	10	-	-	-	-	-	-	-	-	-	-	-
Cylindre HG5 30 x 80 mm laiton 3 clés	00053080 <small>NS</small>	10	-	-	-	-	-	-	-	-	-	-	-
Cylindre HG5 35 x 40 mm laiton 3 clés	00053540 <small>NS</small>	10	-	-	-	-	-	-	-	-	-	-	-
Cylindre HG5 35 x 45 mm laiton 3 clés	00053545 <small>NS</small>	10	-	-	-	-	-	-	-	-	-	-	-
Cylindre HG5 35 x 50 mm laiton 3 clés	00053550 <small>NS</small>	10	-	-	-	-	-	-	-	-	-	-	-
Cylindre HG5 35 x 55 mm laiton 3 clés	00053555 <small>NS</small>	10	-	-	-	-	-	-	-	-	-	-	-
Cylindre HG5 35 x 60 mm laiton 3 clés	00053560 <small>NS</small>	10	-	-	-	-	-	-	-	-	-	-	-
Cylindre HG5 35 x 70 mm laiton 3 clés	00053570 <small>NS</small>	10	-	-	-	-	-	-	-	-	-	-	-
Cylindre HG5 40 x 45 mm laiton 3 clés	00054045 <small>NS</small>	10	-	-	-	-	-	-	-	-	-	-	-
Cylindre HG5 40 x 50 mm laiton 3 clés	00054050 <small>NS</small>	10	-	-	-	-	-	-	-	-	-	-	-
Cylindre HG5 40 x 55 mm laiton 3 clés	00054055 <small>NS</small>	10	-	-	-	-	-	-	-	-	-	-	-
Cylindre HG5 40 x 60 mm laiton 3 clés	00054060 <small>NS</small>	10	-	-	-	-	-	-	-	-	-	-	-
Cylindre HG5 40 x 70 mm laiton 3 clés	00054070 <small>NS</small>	10	-	-	-	-	-	-	-	-	-	-	-
Cylindre HG5 45 x 50 mm laiton 3 clés	00054550 <small>NS</small>	10	-	-	-	-	-	-	-	-	-	-	-
Cylindre HG5 45 x 55 mm laiton 3 clés	00054555 <small>NS</small>	10	-	-	-	-	-	-	-	-	-	-	-
Cylindre HG5 45 x 60 mm laiton 3 clés	00054560 <small>NS</small>	10	-	-	-	-	-	-	-	-	-	-	-



NS Non stocké/Non-stored/Productos no estocado - ■ Sur stock Europe Zone 1 et Zone 2, nous consulter pour délai d'approvisionnement - ■ Epuement/Stock depletion/Agotamiento del stock

Designation	Boite	Colis.	Prix	Sachet	Colis.	Prix	Brochable					Colis.	Prix
							France	Euro 1	Euro 2	Euro 3	Euro 4		
Cylindre HG5 45 x 70 mm laiton 3 clés	00054570 NS	10	-	-	-	-	-	-	-	-	-	-	-
Cylindre HG5 50 x 55 mm laiton 3 clés	00055055 NS	10	-	-	-	-	-	-	-	-	-	-	-
Cylindre HG5 50 x 60 mm laiton 3 clés	00055060 NS	10	-	-	-	-	-	-	-	-	-	-	-
Cylindre HG5 50 x 70 mm laiton 3 clés	00055070 NS	10	-	-	-	-	-	-	-	-	-	-	-
Cylindre HG5 55 x 60 mm laiton 3 clés	00055560 NS	10	-	-	-	-	-	-	-	-	-	-	-
Cylindre HG5 à bouton 30 x 10 mm laiton 3 clés	00073010 NS	10	-	-	-	-	-	-	-	-	-	-	-
Cylindre HG5 à bouton 35 x 10 mm laiton 3 clés	00073510 NS	10	-	-	-	-	-	-	-	-	-	-	-
Cylindre HG5 à bouton 40 x 10 mm laiton 3 clés	00074010 NS	10	-	-	-	-	-	-	-	-	-	-	-
Cylindre HG5 à bouton 30 x 30 mm laiton 3 clés	00073030 NS	10	-	-	-	-	-	-	-	-	-	-	-
Cylindre HG5 à bouton 30 x 35 mm laiton 3 clés	00073035 NS	10	-	-	-	-	-	-	-	-	-	-	-
Cylindre HG5 à bouton 30 x 40 mm laiton 3 clés	00073040 NS	10	-	-	-	-	-	-	-	-	-	-	-
Cylindre HG5 à bouton 30 x 45 mm laiton 3 clés	00073045 NS	10	-	-	-	-	-	-	-	-	-	-	-
Cylindre HG5 à bouton 30 x 50 mm laiton 3 clés	00073050 NS	10	-	-	-	-	-	-	-	-	-	-	-
Cylindre HG5 à bouton 30 x 55 mm laiton 3 clés	00073055 NS	10	-	-	-	-	-	-	-	-	-	-	-
Cylindre HG5 à bouton 30 x 60 mm laiton 3 clés	00073060 NS	10	-	-	-	-	-	-	-	-	-	-	-
Cylindre HG5 à bouton 30 x 65 mm laiton 3 clés	00073065 NS	10	-	-	-	-	-	-	-	-	-	-	-
Cylindre HG5 à bouton 30 x 70 mm laiton 3 clés	00073070 NS	10	-	-	-	-	-	-	-	-	-	-	-
Cylindre HG5 à bouton 35 x 35 mm laiton 3 clés	00073535 NS	10	-	-	-	-	-	-	-	-	-	-	-
Cylindre HG5 à bouton 35 x 40 mm laiton 3 clés	00073540 NS	10	-	-	-	-	-	-	-	-	-	-	-
Cylindre HG5 à bouton 35 x 45 mm laiton 3 clés	00073545 NS	10	-	-	-	-	-	-	-	-	-	-	-
Cylindre HG5 à bouton 35 x 50 mm laiton 3 clés	00073550 NS	10	-	-	-	-	-	-	-	-	-	-	-
Cylindre HG5 à bouton 35 x 55 mm laiton 3 clés	00073555 NS	10	-	-	-	-	-	-	-	-	-	-	-
Cylindre HG5 à bouton 35 x 60 mm laiton 3 clés	00073560 NS	10	-	-	-	-	-	-	-	-	-	-	-
Cylindre HG5 à bouton 35 x 70 mm laiton 3 clés	00073570 NS	10	-	-	-	-	-	-	-	-	-	-	-
Cylindre HG5 à bouton 40 x 40 mm laiton 3 clés	00074040 NS	10	-	-	-	-	-	-	-	-	-	-	-
Cylindre HG5 à bouton 40 x 45 mm laiton 3 clés	00074045 NS	10	-	-	-	-	-	-	-	-	-	-	-
Cylindre HG5 à bouton 40 x 50 mm laiton 3 clés	00074050 NS	10	-	-	-	-	-	-	-	-	-	-	-
Cylindre HG5 à bouton 40 x 55 mm laiton 3 clés	00074055 NS	10	-	-	-	-	-	-	-	-	-	-	-
Cylindre HG5 à bouton 40 x 60 mm laiton 3 clés	00074060 NS	10	-	-	-	-	-	-	-	-	-	-	-
Cylindre HG5 à bouton 40 x 70 mm laiton 3 clés	00074070 NS	10	-	-	-	-	-	-	-	-	-	-	-

NS Non stocké/Non-stored/Productos no estocado - ☑ Sur stock Europe Zone 1 et Zone 2, nous consulter pour délai d'approvisionnement - ☒ Epuisement/Stock depletion/Agotamiento del stock

Cylindre de sûreté / HG 5

PROTECT

Système à multi-profil
pour la réalisation
d'organigramme.



NIVEAU DE SÉCURITÉ



GARANTIE



X 3



Protection
Arrachement

Description/Description/Descripción

Profil européen. Mécanisme à 5 goupilles en maillechort.
Panneton anti arrachement. 3 clés en acier nickelé.
(laiton pour organigramme).

*European profile. 5 pin mechanism. Driver cam made
of powdered metal. 3 nickel plated steel keys. (brass for
master keying system).*

Perfil europeo. Mecanismo de 5 pasadores de
alpacaPivote de acero sinterizado. 3 llaves de acero
niquelado. (latón en organigrama).

Finition/Finish/Acabado

Laiton ou nickelé

Brass or nickel plated

Latón o niquelado

Versión/Option/Versión

Possibilité de montage avec panneton débrayablePoint
Service disponible.

Emergency function on request.

Possibilidad de montaje con sistema de emergencia.

Utilisation/Use/Utilización

Système organigramme.

Master keying system.

Sistema con organigrama.



Designation	Boîte	Colis.	Prix	Sachet	Colis.	Prix	Brochable					Colis.	Prix
							France	Euro 1	Euro 2	Euro 3	Euro 4		
Cylindre HG5 30 x 10 mm nickelé 3 clés	00053011 <small>NS</small>	10	-	-	-	-	00253011	-	-	-	-	5	-
Cylindre HG5 35 x 30 mm nickelé 3 clés	00053511 <small>NS</small>	10	-	-	-	-	-	-	-	-	-	-	-
Cylindre HG5 40 x 10 mm nickelé 3 clés	00054011 <small>NS</small>	10	-	-	-	-	-	-	-	-	-	-	-
Cylindre HG5 45 x 10 mm nickelé 3 clés	00054511 <small>NS</small>	10	-	-	-	-	-	-	-	-	-	-	-
Cylindre HG5 50 x 10 mm nickelé 3 clés	00055019 <small>NS</small>	10	-	-	-	-	-	-	-	-	-	-	-
Cylindre HG5 55 x 10 mm nickelé 3 clés	00055511 <small>NS</small>	10	-	-	-	-	-	-	-	-	-	-	-
Cylindre HG5 60 x 10 mm nickelé 3 clés	00056015 <small>NS</small>	10	-	-	-	-	-	-	-	-	-	-	-
Cylindre HG5 70 x 10 mm nickelé 3 clés	00057011 <small>NS</small>	10	-	-	-	-	-	-	-	-	-	-	-
Cylindre HG5 80 x 10 mm nickelé 3 clés	00058011 <small>NS</small>	10	-	-	-	-	-	-	-	-	-	-	-
Cylindre HG5 90 x 10 mm nickelé 3 clés	00059011 <small>NS</small>	10	-	-	-	-	-	-	-	-	-	-	-
Cylindre HG5 30 x 30 mm nickelé 3 clés	00053031	10	-	-	-	-	00253031	-	-	-	-	5	-

NS Non stocké/Non-stored/Producto no estocado - Sur stock Europe Zone 1 et Zone 2, nous consulter pour délai d'approvisionnement - E Epuisement/Stock depletion/Agotamiento del stock

Designation	Boite	Colis.	Prix	Sachet	Colis.	Prix	Brochable					Colis.	Prix
							France	Euro 1	Euro 2	Euro 3	Euro 4		
Cylindre HG5 35 x 35 mm nickelé 3 clés	00053536	10	-	-	-	-	00253536	-	-	-	-	5	-
Cylindre HG5 40 x 40 mm nickelé 3 clés	00054041	10	-	-	-	-	00254041	-	-	-	-	5	-
Cylindre HG5 45 x 45 mm nickelé 3 clés	00054546 NS	10	-	-	-	-	00254546	-	-	-	-	5	-
Cylindre HG5 50 x 50 mm nickelé 3 clés	00055051 NS	10	-	-	-	-	-	-	-	-	-	-	-
Cylindre HG5 55 x 55 mm nickelé 3 clés	00055556 NS	10	-	-	-	-	-	-	-	-	-	-	-
Cylindre HG5 60 x 60 mm nickelé 3 clés	00056061 NS	10	-	-	-	-	-	-	-	-	-	-	-
Cylindre HG5 30 x 35 mm nickelé 3 clés	00053036 NS	10	-	-	-	-	-	-	-	-	-	-	-
Cylindre HG5 30 x 40 mm nickelé 3 clés	00053041	10	-	-	-	-	00253041	-	-	-	-	5	-
Cylindre HG5 30 x 45 mm nickelé 3 clés	00053046 NS	10	-	-	-	-	-	-	-	-	-	-	-
Cylindre HG5 30 x 50 mm nickelé 3 clés	00053051	10	-	-	-	-	00253051	-	-	-	-	5	-
Cylindre HG5 30 x 55 mm nickelé 3 clés	00053056 NS	10	-	-	-	-	-	-	-	-	-	-	-
Cylindre HG5 30 x 60 mm nickelé 3 clés	00053061	10	-	-	-	-	00253061	-	-	-	-	5	-
Cylindre HG5 30 x 65 mm nickelé 3 clés	00053066 NS	10	-	-	-	-	-	-	-	-	-	-	-
Cylindre HG5 30 x 70 mm nickelé 3 clés	00053071 NS	10	-	-	-	-	-	-	-	-	-	-	-
Cylindre HG5 30 x 80 mm nickelé 3 clés	00053086 NS	10	-	-	-	-	-	-	-	-	-	-	-
Cylindre HG5 35 x 40 mm nickelé 3 clés	00053541 NS	10	-	-	-	-	-	-	-	-	-	-	-
Cylindre HG5 35 x 45 mm nickelé 3 clés	00053546	10	-	-	-	-	00253546	-	-	-	-	5	-
Cylindre HG5 35 x 50 mm nickelé 3 clés	00053551 NS	10	-	-	-	-	-	-	-	-	-	-	-
Cylindre HG5 35 x 55 mm nickelé 3 clés	00053556 NS	10	-	-	-	-	-	-	-	-	-	-	-
Cylindre HG5 35 x 60 mm nickelé 3 clés	00053561 NS	10	-	-	-	-	-	-	-	-	-	-	-
Cylindre HG5 35 x 70 mm nickelé 3 clés	00053571 NS	10	-	-	-	-	-	-	-	-	-	-	-
Cylindre HG5 40 x 45 mm nickelé 3 clés	00054046 NS	10	-	-	-	-	-	-	-	-	-	-	-
Cylindre HG5 40 x 50 mm nickelé 3 clés	00054051 NS	10	-	-	-	-	00254051	-	-	-	-	5	-
Cylindre HG5 40 x 55 mm nickelé 3 clés	00054056 NS	10	-	-	-	-	00254056	-	-	-	-	5	-
Cylindre HG5 40 x 60 mm nickelé 3 clés	00054061 NS	10	-	-	-	-	00254061	-	-	-	-	5	-
Cylindre HG5 40 x 70 mm nickelé 3 clés	00054071 NS	10	-	-	-	-	-	-	-	-	-	-	-
Cylindre HG5 45 x 50 mm nickelé 3 clés	00054551 NS	10	-	-	-	-	-	-	-	-	-	-	-
Cylindre HG5 45 x 55 mm nickelé 3 clés	00054556 NS	10	-	-	-	-	-	-	-	-	-	-	-
Cylindre HG5 45 x 60 mm nickelé 3 clés	00054561 NS	10	-	-	-	-	-	-	-	-	-	-	-
Cylindre HG5 45 x 70 mm nickelé 3 clés	00054571 NS	10	-	-	-	-	-	-	-	-	-	-	-

NS Non stocké/Non-stored/Producto no estocado - ☐ Sur stock Europe Zone 1 et Zone 2, nous consulter pour délai d'approvisionnement - ☒ Epuisement/Stock depletion/Agotamiento del stock

Designation	Boite	Colis.	Prix	Sachet	Colis.	Prix	Brochable					Colis.	Prix
							France	Euro 1	Euro 2	Euro 3	Euro 4		
Cylindre HG5 50 x 55 mm nickelé 3 clés	00055056 <small>NS</small>	10	-	-	-	-	-	-	-	-	-	-	-
Cylindre HG5 50 x 60 mm nickelé 3 clés	00055061 <small>NS</small>	10	-	-	-	-	-	-	-	-	-	-	-
Cylindre HG5 50 x 70 mm nickelé 3 clés	00055071 <small>NS</small>	10	-	-	-	-	-	-	-	-	-	-	-
Cylindre HG5 55 x 60 mm nickelé 3 clés	00055561 <small>NS</small>	10	-	-	-	-	-	-	-	-	-	-	-
Cylindre HG5 à bouton 30 x 10 mm nickelé 3 clés	00073011 <small>NS</small>	10	-	-	-	-	-	-	-	-	-	-	-
Cylindre HG5 à bouton 35 x 10 mm nickelé 3 clés	00073511 <small>NS</small>	10	-	-	-	-	-	-	-	-	-	-	-
Cylindre HG5 à bouton 40 x 10 mm nickelé 3 clés	00074011 <small>NS</small>	10	-	-	-	-	-	-	-	-	-	-	-
Cylindre HG5 à bouton 30 x 30 mm nickelé 3 clés	00073031 <small>NS</small>	10	-	-	-	-	00273031	-	-	-	-	5	-
Cylindre HG5 à bouton 30 x 35 mm nickelé 3 clés	00073036 <small>NS</small>	10	-	-	-	-	-	-	-	-	-	-	-
Cylindre HG5 à bouton 30 x 40 mm nickelé 3 clés	00073041 <small>NS</small>	10	-	-	-	-	00273041	-	-	-	-	5	-
Cylindre HG5 à bouton 30 x 45 mm nickelé 3 clés	00073046 <small>NS</small>	10	-	-	-	-	-	-	-	-	-	-	-
Cylindre HG5 à bouton 30 x 50 mm nickelé 3 clés	00073051 <small>NS</small>	10	-	-	-	-	-	-	-	-	-	-	-
Cylindre HG5 à bouton 30 x 55 mm nickelé 3 clés	00073056 <small>NS</small>	10	-	-	-	-	-	-	-	-	-	-	-
Cylindre HG5 à bouton 30 x 60 mm nickelé 3 clés	00073061 <small>NS</small>	10	-	-	-	-	-	-	-	-	-	-	-
Cylindre HG5 à bouton 30 x 65 mm nickelé 3 clés	00073066 <small>NS</small>	10	-	-	-	-	-	-	-	-	-	-	-
Cylindre HG5 à bouton 30 x 70 mm nickelé 3 clés	00073071 <small>NS</small>	10	-	-	-	-	-	-	-	-	-	-	-
Cylindre HG5 à bouton 35 x 35 mm nickelé 3 clés	00073536 <small>NS</small>	10	-	-	-	-	-	-	-	-	-	-	-
Cylindre HG5 à bouton 35 x 40 mm nickelé 3 clés	00073541 <small>NS</small>	10	-	-	-	-	-	-	-	-	-	-	-
Cylindre HG5 à bouton 35 x 45 mm nickelé 3 clés	00073546 <small>NS</small>	10	-	-	-	-	-	-	-	-	-	-	-
Cylindre HG5 à bouton 35 x 50 mm nickelé 3 clés	00073551 <small>NS</small>	10	-	-	-	-	-	-	-	-	-	-	-
Cylindre HG5 à bouton 35 x 55 mm nickelé 3 clés	00073556 <small>NS</small>	10	-	-	-	-	-	-	-	-	-	-	-
Cylindre HG5 à bouton 35 x 60 mm nickelé 3 clés	00073561 <small>NS</small>	10	-	-	-	-	-	-	-	-	-	-	-
Cylindre HG5 à bouton 35 x 70 mm nickelé 3 clés	00073571 <small>NS</small>	10	-	-	-	-	-	-	-	-	-	-	-
Cylindre HG5 à bouton 40 x 30 mm nickelé 3 clés	00074031 <small>NS</small>	10	-	-	-	-	00274031	-	-	-	-	5	-
Cylindre HG5 à bouton 40 x 40 mm nickelé 3 clés	00074041 <small>NS</small>	10	-	-	-	-	00274041	-	-	-	-	5	-
Cylindre HG5 à bouton 40 x 45 mm nickelé 3 clés	00074046 <small>NS</small>	10	-	-	-	-	-	-	-	-	-	-	-
Cylindre HG5 à bouton 40 x 50 mm nickelé 3 clés	00074051 <small>NS</small>	10	-	-	-	-	-	-	-	-	-	-	-
Cylindre HG5 à bouton 40 x 55 mm nickelé 3 clés	00074056 <small>NS</small>	10	-	-	-	-	-	-	-	-	-	-	-
Cylindre HG5 à bouton 40 x 60 mm nickelé 3 clés	00074061 <small>NS</small>	10	-	-	-	-	-	-	-	-	-	-	-
Cylindre HG5 à bouton 40 x 70 mm nickelé 3 clés	00074071 <small>NS</small>	10	-	-	-	-	-	-	-	-	-	-	-

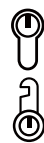

Cylindre de sûreté / HG 6

PROTECT



NIVEAU DE SÉCURITÉ



GARANTIE



X 3

Système à multi-profil à 6 goupilles pour la réalisation d'organigramme.



Protection
Arrachement

Description/Descripción/Descripción

Profil européen. Mécanisme à 6 goupilles en maillechort. Panneton anti arrachement. 3 clés en acier nickelé (laiton sur organigramme).

European profile. 6 pin mechanism. Driver cam made of powdered metal. 3 nickel plated steel keys (brass for master keying system).

Perfil europeo. Mecanismo de 6 pasadores de alpaca. Pivote de acero sinterizado. 3 llaves de acero niquelado (latón en organigrama).

Finition/Finish/Acabado

Laiton

Brass

Latón

Version/Option/Versión

Panneton orientable pour la dimension 35 x 10 (autres dimensions sur demande). Ouverture par clé passe PTT et ou EDF.

With ajustable driver cam for 35x10 (other dimensions on request).

Paletón orientable para el dimension 35 x 10 (otras dimensiones sobre demanda).

Utilisation/Use/Utilización

Système organigramme

Master keying system

Sistema con organigrama

Designation	Boite	Colis.	Prix	Sachet	Colis.	Prix	Brochable					Colis.	Prix
							France	Euro 1	Euro 2	Euro 3	Euro 4		
Demi-cylindre HG6 35 x 10 mm laiton panneton orientable 3 clés	00063510 NS	10	-	-	-	-	-	-	-	-	-	-	-
Demi-cylindre HG6 40 x 10 mm laiton 3 clés	00064110 NS	10	-	-	-	-	-	-	-	-	-	-	-
Demi-cylindre HG6 45 x 10 mm laiton 3 clés	00064510 NS	10	-	-	-	-	-	-	-	-	-	-	-
Demi-cylindre HG6 50 x 10 mm laiton 3 clés	00065010 NS	10	-	-	-	-	-	-	-	-	-	-	-
Demi-cylindre HG6 55 x 10 mm laiton 3 clés	00065510 NS	10	-	-	-	-	-	-	-	-	-	-	-
Demi-cylindre HG6 60 x 10 mm laiton 3 clés	00066119 NS	10	-	-	-	-	-	-	-	-	-	-	-

NS Non stocké/Non-stored/Producto no estocado - ☑ Sur stock Europe Zone 1 et Zone 2, nous consulter pour délai d'approvisionnement - ☒ Epuisement/Stock depletion/Agotamiento del stock

Cylindre de sûreté / HG 6

PROTECT



NIVEAU DE SÉCURITÉ



Designation	Boite	Colis.	Prix	Sachet	Colis.	Prix	Brochable					Colis.	Prix
							France	Euro 1	Euro 2	Euro 3	Euro 4		
Demi-cylindre HG6 70 x 10 mm laiton 3 clés	00067119 <small>NS</small>	10	-	-	-	-	-	-	-	-	-	-	-
Demi-cylindre HG6 80 x 10 mm laiton 3 clés	00068010 <small>NS</small>	10	-	-	-	-	-	-	-	-	-	-	-
Demi-cylindre HG6 90 x 10 mm laiton 3 clés	00069010 <small>NS</small>	10	-	-	-	-	-	-	-	-	-	-	-
Cylindre HG6 35 x 35 mm laiton 3 clés	00063535 <small>NS</small>	10	-	-	-	-	-	-	-	-	-	-	-
Cylindre HG6 40 x 40 mm laiton 3 clés	00064040 <small>NS</small>	10	-	-	-	-	-	-	-	-	-	-	-
Cylindre HG6 45 x 45 mm laiton 3 clés	00064545 <small>NS</small>	10	-	-	-	-	-	-	-	-	-	-	-
Cylindre HG6 50 x 50 mm laiton 3 clés	00065050 <small>NS</small>	10	-	-	-	-	-	-	-	-	-	-	-
Cylindre HG6 60 x 60 mm laiton 3 clés	00066060 <small>NS</small>	10	-	-	-	-	-	-	-	-	-	-	-
Cylindre HG6 35 x 40 mm laiton 3 clés	00063540 <small>NS</small>	10	-	-	-	-	-	-	-	-	-	-	-
Cylindre HG6 35 x 45 mm laiton 3 clés	00063545 <small>NS</small>	10	-	-	-	-	-	-	-	-	-	-	-
Cylindre HG6 35 x 50 mm laiton 3 clés	00063550 <small>NS</small>	10	-	-	-	-	-	-	-	-	-	-	-
Cylindre HG6 35 x 55 mm laiton 3 clés	00063555 <small>NS</small>	10	-	-	-	-	-	-	-	-	-	-	-
Cylindre HG6 35 x 60 mm laiton 3 clés	00063569 <small>NS</small>	10	-	-	-	-	-	-	-	-	-	-	-
Cylindre HG6 35 x 65 mm laiton 3 clés	00063565 <small>NS</small>	10	-	-	-	-	-	-	-	-	-	-	-
Cylindre HG6 35 x 70 mm laiton 3 clés	00063570 <small>NS</small>	10	-	-	-	-	-	-	-	-	-	-	-
Cylindre HG6 35 x 80 mm laiton 3 clés	00063580 <small>NS</small>	10	-	-	-	-	-	-	-	-	-	-	-
Cylindre HG6 40 x 45 mm laiton 3 clés	00064049 <small>NS</small>	10	-	-	-	-	-	-	-	-	-	-	-
Cylindre HG6 40 x 50 mm laiton 3 clés	00064050 <small>NS</small>	10	-	-	-	-	-	-	-	-	-	-	-
Cylindre HG6 40 x 55 mm laiton 3 clés	00064055 <small>NS</small>	10	-	-	-	-	-	-	-	-	-	-	-
Cylindre HG6 40 x 60 mm laiton 3 clés	00064060 <small>NS</small>	10	-	-	-	-	-	-	-	-	-	-	-
Cylindre HG6 40 x 70 mm laiton 3 clés	00064070 <small>NS</small>	10	-	-	-	-	-	-	-	-	-	-	-
Cylindre HG6 45 x 50 mm laiton 3 clés	00064550 <small>NS</small>	10	-	-	-	-	-	-	-	-	-	-	-
Cylindre HG6 45 x 55 mm laiton 3 clés	00064555 <small>NS</small>	10	-	-	-	-	-	-	-	-	-	-	-
Cylindre HG6 45 x 60 mm laiton 3 clés	00064560 <small>NS</small>	10	-	-	-	-	-	-	-	-	-	-	-
Cylindre HG6 45 x 70 mm laiton 3 clés	00064570 <small>NS</small>	10	-	-	-	-	-	-	-	-	-	-	-
Cylindre HG6 50 x 55 mm laiton 3 clés	00065055 <small>NS</small>	10	-	-	-	-	-	-	-	-	-	-	-



NS Non stocké/Non-stored/Productos no estocado - ■ Sur stock Europe Zone 1 et Zone 2, nous consulter pour délai d'approvisionnement - E Epuement/Stock depletion/Agotamiento del stock

Cylindre de sûreté / HG 6

PROTECT



NIVEAU DE SÉCURITÉ



Designation	Boîte	Colis.	Prix	Sachet	Colis.	Prix	Brochable					Colis.	Prix
							France	Euro 1	Euro 2	Euro 3	Euro 4		
Cylindre HG6 50 x 60 mm laiton 3 clés	00065060 NS	10	-	-	-	-	-	-	-	-	-	-	-
Cylindre HG6 50 x 70 mm laiton 3 clés	00065070 NS	10	-	-	-	-	-	-	-	-	-	-	-
Cylindre HG6 55 x 60 mm laiton 3 clés	00065560 NS	10	-	-	-	-	-	-	-	-	-	-	-
Cylindre HG6 55 x 70 mm laiton 3 clés	00065555 NS	10	-	-	-	-	-	-	-	-	-	-	-
Demi cylindre HG6 à bouton 35 x 10 mm laiton 3 clés	00083510 NS	10	-	-	-	-	-	-	-	-	-	-	-
Demi cylindre HG6 à bouton 40 x 10 mm laiton 3 clés	00084010 NS	10	-	-	-	-	-	-	-	-	-	-	-
Cylindre HG6 à bouton 30 x 35 mm laiton 3 clés	00083035 NS	10	-	-	-	-	-	-	-	-	-	-	-
Cylindre HG6 à bouton 30 x 40 mm laiton 3 clés	00083040 NS	10	-	-	-	-	-	-	-	-	-	-	-
Cylindre HG6 à bouton 30 x 45 mm laiton 3 clés	00083045 NS	10	-	-	-	-	-	-	-	-	-	-	-
Cylindre HG6 à bouton 30 x 50 mm laiton 3 clés	00083050 NS	10	-	-	-	-	-	-	-	-	-	-	-
Cylindre HG6 à bouton 30 x 55 mm laiton 3 clés	00083055 NS	10	-	-	-	-	-	-	-	-	-	-	-
Cylindre HG6 à bouton 30 x 60 mm laiton 3 clés	00083060 NS	10	-	-	-	-	-	-	-	-	-	-	-
Cylindre HG6 à bouton 30 x 65 mm laiton 3 clés	00083065 NS	10	-	-	-	-	-	-	-	-	-	-	-
Cylindre HG6 à bouton 30 x 70 mm laiton 3 clés	00083070 NS	10	-	-	-	-	-	-	-	-	-	-	-
Cylindre HG6 à bouton 35 x 35 mm laiton 3 clés	00083535 NS	10	-	-	-	-	-	-	-	-	-	-	-
Cylindre HG6 à bouton 35 x 40 mm laiton 3 clés	00083540 NS	10	-	-	-	-	-	-	-	-	-	-	-
Cylindre HG6 à bouton 35 x 45 mm laiton 3 clés	00083545 NS	10	-	-	-	-	-	-	-	-	-	-	-
Cylindre HG6 à bouton 35 x 50 mm laiton 3 clés	00083550 NS	10	-	-	-	-	-	-	-	-	-	-	-
Cylindre HG6 à bouton 35 x 55 mm laiton 3 clés	00083555 NS	10	-	-	-	-	-	-	-	-	-	-	-
Cylindre HG6 à bouton 35 x 60 mm laiton 3 clés	00083560 NS	10	-	-	-	-	-	-	-	-	-	-	-
Cylindre HG6 à bouton 35 x 70 mm laiton 3 clés	00083570 NS	10	-	-	-	-	-	-	-	-	-	-	-
Cylindre HG6 à bouton 40 x 40 mm laiton 3 clés	00084040 NS	10	-	-	-	-	-	-	-	-	-	-	-
Cylindre HG6 à bouton 40 x 45 mm laiton 3 clés	00084045 NS	10	-	-	-	-	-	-	-	-	-	-	-
Cylindre HG6 à bouton 40 x 50 mm laiton 3 clés	00084050 NS	10	-	-	-	-	-	-	-	-	-	-	-
Cylindre HG6 à bouton 40 x 55 mm laiton 3 clés	00084055 NS	10	-	-	-	-	-	-	-	-	-	-	-
Cylindre HG6 à bouton 40 x 60 mm laiton 3 clés	00084060 NS	10	-	-	-	-	-	-	-	-	-	-	-
Cylindre HG6 à bouton 40 x 70 mm laiton 3 clés	00084070 NS	10	-	-	-	-	-	-	-	-	-	-	-

NS Non stocké/Non-stored/Producto no estocado - ☐ Sur stock Europe Zone 1 et Zone 2, nous consulter pour délai d'approvisionnement - ☒ Epuisement/Stock depletion/Agotamiento del stock

Cylindre de sûreté / HG 6

PROTECT

Système à multi-profil à 6 goupilles pour la réalisation d'organigramme.



NIVEAU DE SÉCURITÉ



GARANTIE



X 3



Protection Arrachement

Description/Description/Descripción

Profil européen. Mécanisme à 6 goupilles en maillechort. Panneton anti arrachement. 3 clés en acier nickelé (laiton sur organigramme).

European profile. 6 pin mechanism. Driver cam made of powdered metal. 3 nickel plated steel keys (brass for master keying system).

Perfil europeo. Mecanismo de 6 pasadores de alpaca. Pivote de acero sinterizado. 3 llaves de acero niquelado (latón en organigrama).

Finition/Finish/Acabado

Laiton ou nickelé

Brass or nickel plated

Latón o niquelado

Version/Option/Versión

Panneton orientable pour la dimension 35 x 10 (autres dimensions sur demande) Ouverture par clé passe PTT et ou EDF.

With adjustable driver cam for 35x10 (other dimensions on request). Opening master key system PTT or EDF.

Paletón orientable para el dimension 35 x 10 (otras dimensiones sobre demanda).

Utilisation/Use/Utilización

Système organigramme

Master keying system

Sistema con organigrama

Designation	Boite	Colis.	Prix	Sachet	Colis.	Prix	Brochable					Colis.	Prix
							France	Euro 1	Euro 2	Euro 3	Euro 4		
Demi-cylindre HG6 35 x 10 mm nickelé panneton orientable 3 clés	00063511 <small>NS</small>	10	-	-	-	-	-	-	-	-	-	-	-
Demi-cylindre HG6 40 x 10 mm nickelé 3 clés	00064111 <small>NS</small>	10	-	-	-	-	-	-	-	-	-	-	-
Demi-cylindre HG6 45 x 10 mm nickelé 3 clés	00064511 <small>NS</small>	10	-	-	-	-	-	-	-	-	-	-	-
Demi-cylindre HG6 50 x 10 mm nickelé 3 clés	00065011 <small>NS</small>	10	-	-	-	-	-	-	-	-	-	-	-
Demi-cylindre HG6 55 x 10 mm nickelé 3 clés	00065511 <small>NS</small>	10	-	-	-	-	-	-	-	-	-	-	-
Demi-cylindre HG6 60 x 10 mm nickelé 3 clés	00066120 <small>NS</small>	10	-	-	-	-	-	-	-	-	-	-	-
Demi-cylindre HG6 70 x 10 mm nickelé 3 clés	00067120 <small>NS</small>	10	-	-	-	-	-	-	-	-	-	-	-

NS Non stocké/Non-stored/Producto no estocado - Sur stock Europe Zone 1 et Zone 2, nous consulter pour délai d'approvisionnement - E Epuisement/Stock depletion/Agotamiento del stock



Cylindre de sûreté / HG 6

PROTECT



NIVEAU DE SÉCURITÉ



Designation	Boite	Colis.	Prix	Sachet	Colis.	Prix	Brochable					Colis.	Prix
							France	Euro 1	Euro 2	Euro 3	Euro 4		
Demi-cylindre HG6 80 x 10 mm nickelé 3 clés	00068011 NS	10	-	-	-	-	-	-	-	-	-	-	-
Demi-cylindre HG6 90 x 10 mm nickelé 3 clés	00069011 NS	10	-	-	-	-	-	-	-	-	-	-	-
Cylindre HG6 35 x 35 mm nickelé 3 clés	00063536 NS	10	-	-	-	-	-	-	-	-	-	-	-
Cylindre HG6 40 x 40 mm nickelé 3 clés	00064041 NS	10	-	-	-	-	-	-	-	-	-	-	-
Cylindre HG6 45 x 45 mm nickelé 3 clés	00064546 NS	10	-	-	-	-	-	-	-	-	-	-	-
Cylindre HG6 50 x 50 mm nickelé 3 clés	00065051 NS	10	-	-	-	-	-	-	-	-	-	-	-
Cylindre HG6 60 x 60 mm nickelé 3 clés	00066061 NS	10	-	-	-	-	-	-	-	-	-	-	-
Cylindre HG6 35 x 40 mm nickelé 3 clés	00063541 NS	10	-	-	-	-	-	-	-	-	-	-	-
Cylindre HG6 35 x 45 mm nickelé 3 clés	00063546 NS	10	-	-	-	-	-	-	-	-	-	-	-
Cylindre HG6 35 x 50 mm nickelé 3 clés	00063558 NS	10	-	-	-	-	-	-	-	-	-	-	-
Cylindre HG6 35 x 55 mm nickelé 3 clés	00063556 NS	10	-	-	-	-	-	-	-	-	-	-	-
Cylindre HG6 35 x 60 mm nickelé 3 clés	00063561 NS	10	-	-	-	-	-	-	-	-	-	-	-
Cylindre HG6 35 x 65 mm nickelé 3 clés	00063566 NS	10	-	-	-	-	-	-	-	-	-	-	-
Cylindre HG6 35 x 70 mm nickelé 3 clés	00063571 NS	10	-	-	-	-	-	-	-	-	-	-	-
Cylindre HG6 35 x 80 mm nickelé 3 clés	00063581 NS	10	-	-	-	-	-	-	-	-	-	-	-
Cylindre HG6 40 x 45 mm nickelé 3 clés	00064046 NS	10	-	-	-	-	-	-	-	-	-	-	-
Cylindre HG6 40 x 50 mm nickelé 3 clés	00064051 NS	10	-	-	-	-	-	-	-	-	-	-	-
Cylindre HG6 40 x 55 mm nickelé 3 clés	00064056 NS	10	-	-	-	-	-	-	-	-	-	-	-
Cylindre HG6 40 x 60 mm nickelé 3 clés	00064061 NS	10	-	-	-	-	-	-	-	-	-	-	-
Cylindre HG6 40 x 70 mm nickelé 3 clés	00064071 NS	10	-	-	-	-	-	-	-	-	-	-	-
Cylindre HG6 45 x 50 mm nickelé 3 clés	00064551 NS	10	-	-	-	-	-	-	-	-	-	-	-
Cylindre HG6 45 x 55 mm nickelé 3 clés	00064556 NS	10	-	-	-	-	-	-	-	-	-	-	-
Cylindre HG6 45 x 60 mm nickelé 3 clés	00064561 NS	10	-	-	-	-	-	-	-	-	-	-	-
Cylindre HG6 45 x 70 mm nickelé 3 clés	00064571 NS	10	-	-	-	-	-	-	-	-	-	-	-
Cylindre HG6 50 x 55 mm nickelé 3 clés	00065056 NS	10	-	-	-	-	-	-	-	-	-	-	-
Cylindre HG6 50 x 60 mm nickelé 3 clés	00065061 NS	10	-	-	-	-	-	-	-	-	-	-	-

NS Non stocké/Non-stored/Producto no estocado - ☐ Sur stock Europe Zone 1 et Zone 2, nous consulter pour délai d'approvisionnement - ☒ Epuisement/Stock depletion/Agotamiento del stock

Cylindre de sûreté / HG 6

PROTECT



NIVEAU DE SÉCURITÉ



Designation	Boite	Colis.	Prix	Sachet	Colis.	Prix	Brochable					Colis.	Prix
							France	Euro 1	Euro 2	Euro 3	Euro 4		
Cylindre HG6 50 x 70 mm nickelé 3 clés	00065071 <small>NS</small>	10	-	-	-	-	-	-	-	-	-	-	-
Cylindre HG6 55 x 60 mm nickelé 3 clés	00065561 <small>NS</small>	10	-	-	-	-	-	-	-	-	-	-	-
Cylindre HG6 55 x 70 mm nickelé 3 clés	00065556 <small>NS</small>	10	-	-	-	-	-	-	-	-	-	-	-
Demi cylindre HG6 à bouton 35 x 10 mm nickelé 3 clés	00083511 <small>NS</small>	10	-	-	-	-	-	-	-	-	-	-	-
Demi cylindre HG6 à bouton 40 x 10 mm nickelé 3 clés	00084011 <small>NS</small>	10	-	-	-	-	-	-	-	-	-	-	-
Cylindre HG6 à bouton 30 x 35 mm nickelé 3 clés	00083036 <small>NS</small>	10	-	-	-	-	-	-	-	-	-	-	-
Cylindre HG6 à bouton 30 x 40 mm nickelé 3 clés	00083041 <small>NS</small>	10	-	-	-	-	-	-	-	-	-	-	-
Cylindre HG6 à bouton 30 x 45 mm nickelé 3 clés	00083046 <small>NS</small>	10	-	-	-	-	-	-	-	-	-	-	-
Cylindre HG6 à bouton 30 x 50 mm nickelé 3 clés	00083051 <small>NS</small>	10	-	-	-	-	-	-	-	-	-	-	-
Cylindre HG6 à bouton 30 x 55 mm nickelé 3 clés	00083056 <small>NS</small>	10	-	-	-	-	-	-	-	-	-	-	-
Cylindre HG6 à bouton 30 x 60 mm nickelé 3 clés	00083061 <small>NS</small>	10	-	-	-	-	-	-	-	-	-	-	-
Cylindre HG6 à bouton 30 x 65 mm nickelé 3 clés	00083066 <small>NS</small>	10	-	-	-	-	-	-	-	-	-	-	-
Cylindre HG6 à bouton 30 x 70 mm nickelé 3 clés	00083071 <small>NS</small>	10	-	-	-	-	-	-	-	-	-	-	-
Cylindre HG6 à bouton 35 x 35 mm nickelé 3 clés	00083536 <small>NS</small>	10	-	-	-	-	-	-	-	-	-	-	-
Cylindre HG6 à bouton 35 x 40 mm nickelé 3 clés	00083541 <small>NS</small>	10	-	-	-	-	-	-	-	-	-	-	-
Cylindre HG6 à bouton 35 x 45 mm nickelé 3 clés	00083546 <small>NS</small>	10	-	-	-	-	-	-	-	-	-	-	-
Cylindre HG6 à bouton 35 x 50 mm nickelé 3 clés	00083551 <small>NS</small>	10	-	-	-	-	-	-	-	-	-	-	-
Cylindre HG6 à bouton 35 x 55 mm nickelé 3 clés	00083556 <small>NS</small>	10	-	-	-	-	-	-	-	-	-	-	-
Cylindre HG6 à bouton 35 x 60 mm nickelé 3 clés	00083561 <small>NS</small>	10	-	-	-	-	-	-	-	-	-	-	-
Cylindre HG6 à bouton 35 x 70 mm nickelé 3 clés	00083571 <small>NS</small>	10	-	-	-	-	-	-	-	-	-	-	-
Cylindre HG6 à bouton 40 x 40 mm nickelé 3 clés	00084041 <small>NS</small>	10	-	-	-	-	-	-	-	-	-	-	-
Cylindre HG6 à bouton 40 x 45 mm nickelé 3 clés	00084046 <small>NS</small>	10	-	-	-	-	-	-	-	-	-	-	-
Cylindre HG6 à bouton 40 x 50 mm nickelé 3 clés	00084051 <small>NS</small>	10	-	-	-	-	-	-	-	-	-	-	-
Cylindre HG6 à bouton 40 x 55 mm nickelé 3 clés	00084056 <small>NS</small>	10	-	-	-	-	-	-	-	-	-	-	-
Cylindre HG6 à bouton 40 x 60 mm nickelé 3 clés	00084061 <small>NS</small>	10	-	-	-	-	-	-	-	-	-	-	-
Cylindre HG6 à bouton 40 x 70 mm nickelé 3 clés	00084071 <small>NS</small>	10	-	-	-	-	-	-	-	-	-	-	-

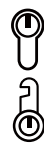

NS Non stocké/Non-stored/Productos no estocado - ■ Sur stock Europe Zone 1 et Zone 2, nous consulter pour délai d'approvisionnement - ■ Epuement/Stock depletion/Agotamiento del stock

Cylindre de sûreté / HG5+

PROTECT



NIVEAU DE SÉCURITÉ



GARANTIE



X 5



Système breveté avec billes de sécurité mobile



Protection Arrachement



Protection Perçage



Protection Crochetage



Protection Snap

Description/Description/Descripción

Profil européen laiton. Mécanisme à 5 goupilles. Protection contre le perçage par 1ère goupille + poussoir en acier trempé. Protection contre l'effraction de la partie saillante du cylindre (anti-snap). Panneton anti arrachement. 5 clés laiton nickelé avec carte de propriété permettant la reproduction des clés. exclusivement en usine. Billes anti-crochetage interne au cylindre interdisant toute reproduction hors usine. Option : Aiguille anti-perçage.

European brass profile. 5 pins mechanism. Protection against drilling by hardened steel pins. Protection against the intrusion of the projecting portion of the cylinder (anti-snap). Driver cam made of powdered metal. 5 nickel plated brass patented keys with personal security card for key copies. Balls anti-picking internal cylinder prohibiting any reproduction. Option : anti-drill pin.

Perfil europeo de latón. Mecanismo de 5 pistones. Protección contra el taladrado mediante un pasador y un empujador de acero templado. Protección contra la manipulación de la parte saliente de cilindro. Pivote de acero sinterizado antiarrancamiento. 5 llaves de latón niquelado patentadas con título de propiedad que permite su reproducción únicamente en fábrica. Bolas anti-forzado internas al cilindro que prohíben cualquier reproducción fuera de fábrica. Opción: Aguja antitaladrado.

Finition/Finish/Acabado

Nickelé. / Nickel plated / Niquelado.

Versión/Option/Versión

Possibilité de montage avec panneton débrayable. Panneton orientable pour la dimension 30 x 10. Emergency function. With ajustable driver cam for 30x10. Posibilidad de montaje con sistema de emergencia. Paletón orientable para el dimension 30x10.

Designation	Boite	Colis.	Prix	Sachet	Colis.	Prix	Brochable					Colis.	Prix
							France	Euro 1	Euro 2	Euro 3	Euro 4		
Demi-cylindre profilé HG5+ 30 x 10mm nickelé panneton orientable 5 clés	00058839 NS	1	-	-	-	-	-	-	-	-	-	-	-
Demi-cylindre profilé HG5+ 60 x 10mm nickelé 5 clés	00058838 NS	1	-	-	-	-	-	-	-	-	-	-	-

NS Non stocké/Non-stored/Producto no estocado - ☑ Sur stock Europe Zone 1 et Zone 2, nous consulter pour délai d'approvisionnement - ☒ Epuisement/Stock depletion/Agotamiento del stock

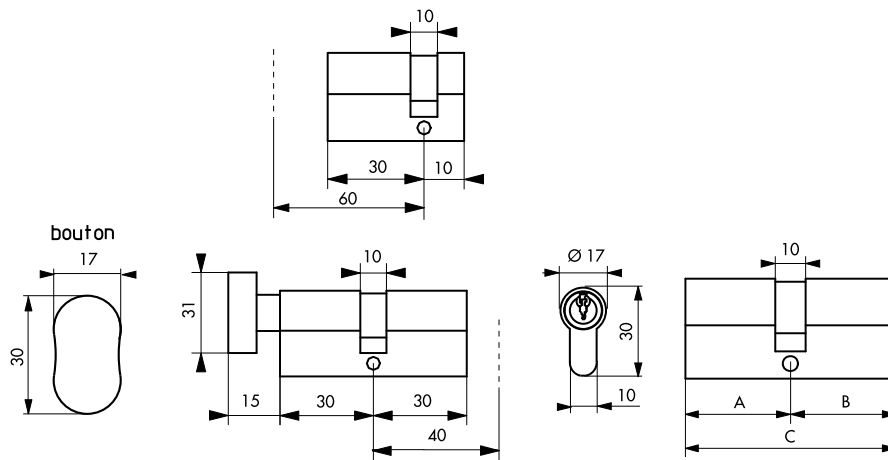

	30x30	35x35	40x40	30x40	30x50	30x60	30x65	35x45
A	30	35	40	30	30	30	30	35
B	30	35	40	40	50	60	65	45
C	60	70	80	70	80	90	95	80

Designation	Boite	Colis.	Prix	Sachet	Colis.	Prix	Brochable					Colis.	Prix
							France	Euro 1	Euro 2	Euro 3	Euro 4		
Cylindre profilé HG5+ 30 x 30mm nickelé 5 clés	00058859 <small>NS</small>	1	-	-	-	-	00247331	-	-	-	-	5	-
Cylindre profilé HG5+ 35 x 35mm nickelé 5 clés	00058879 <small>NS</small>	1	-	-	-	-	-	-	-	-	-	-	-
Cylindre profilé HG5+ 40 x 40mm nickelé 5 clés	00058889 <small>NS</small>	1	-	-	-	-	00247382	-	-	-	-	5	-
Cylindre profilé HG5+ 30 x 40mm nickelé 5 clés	00058869 <small>NS</small>	1	-	-	-	-	00247341	-	-	-	-	5	-
Cylindre profilé HG5+ 30 x 50mm nickelé 5 clés	00058880 <small>NS</small>	1	-	-	-	-	-	-	-	-	-	-	-
Cylindre profilé HG5+ 30 x 60mm nickelé 5 clés	00058890 <small>NS</small>	1	-	-	-	-	00247361	-	-	-	-	5	-
Cylindre profilé HG5+ 30 x 65mm nickelé 5 clés	00058896 <small>NS</small>	1	-	-	-	-	-	-	-	-	-	-	-
Cylindre profilé HG5+ 35 x 45mm nickelé 5 clés	00058881 <small>NS</small>	1	-	-	-	-	-	-	-	-	-	-	-
Cylindre profilé HG5+ à bouton 30 x 30mm nickelé 5 clés	00058861 <small>NS</small>	1	-	-	-	-	-	-	-	-	-	-	-
Cylindre profilé HG5+ à bouton 30 x 40mm nickelé 5 clés	00058856 <small>NS</small>	1	-	-	-	-	-	-	-	-	-	-	-
Cylindre profilé HG5+ 35 x 30mm SNAP côté 30mm nickelé 5 clés	00058960 <small>NS</small>	1	-	-	-	-	-	-	-	-	-	-	-
Cylindre profilé HG5+ 40 x 30mm SNAP côté 30mm nickelé 5 clés	00058961 <small>NS</small>	1	-	-	-	-	-	-	-	-	-	-	-
Cylindre profilé HG5+ 45 x 30mm SNAP côté 30mm nickelé 5 clés	00058962 <small>NS</small>	1	-	-	-	-	-	-	-	-	-	-	-



Cylindre de haute sûreté / HG5+ POUR ORGANIGRAMME PROTECT



NIVEAU DE SÉCURITÉ



GARANTIE



X 3



Description/Description/Descripción

Profil européen laiton. Mécanisme à 5 goupilles. Protection contre le perçage par 1ère goupille + poussoir en acier trempé. Protection contre l'effraction de la partie saillante du cylindre (anti-snap). Panneton anti arrachement. 3 clés plates avec carte de propriété permettant la reproduction des clés exclusivement en usine. Pièce mobile anti-crochetage interne au cylindre interdisant toute reproduction hors usine. Option : Aiguille anti-perçage.

European brass profile. 5 pins mechanism. Protection against drilling by hardened steel pins. Protection against the intrusion of the projecting portion of the cylinder (anti-snap). Driver cam made of powdered metal. 3 patented keys with personal security card for key copies. Internal moving parts anti-picking cylinder prohibiting any reproduction. Option : anti-drill pin.

Perfil europeo de latón. Mecanismo de 5 pistones. Protección contra el taladrado mediante un pasador y un empujador de acero templado. Protección contra la manipulación de la parte saliente de cilindro. Pivote de acero sinterizado antiarrancamiento. 3 llaves planas reversibles patentadas con título de propiedad que permite su reproducción únicamente en fábrica. Opción: Aguja antitaladrado.

Finition/Finish/Acabado

Nickel velours
Dull nickel plated
Níquel terciopelo

Versión/Option/Versión

Cylindre 2 entrées. Cylindre à bouton 1 entrée. Possibilité de montage avec panneton débrayable. Panneton orientable pour les dimensions 30 x 10 et 35 x 10. (autres dimensions sur demande). Point Service disponible. Possibilité de montage avec bouton débrayable. *cylinder with key way. Cylinder with 2 key ways. Cylinder with key way and inside knob. Emergency function. With ajustable driver cam for 30x10 and 35x10 (other dimensions on request).*

Cilindro de botón de 1 entrada. Posibilidad de montaje con sistema de emergencia. Paletón orientable para las dimensiones 30x10 y 35x10 (otras dimensiones sobre demanda).

Designation	Boite	Colis.	Prix	Sachet	Colis.	Prix	Brochable					Colis.	Prix
							France	Euro 1	Euro 2	Euro 3	Euro 4		
Demi-cylindre profilé HG5+ 30 x 10mm nickelé 3 clés panneton orientable	00058811 NS	1	-	-	-	-	-	-	-	-	-	-	-
Cylindre profilé HG5+ 35 x 10mm nickelé 3 clés	00058812 NS	1	-	-	-	-	-	-	-	-	-	-	-
Cylindre profilé HG5+ 40 x 10mm nickelé 3 clés	00058813 NS	1	-	-	-	-	-	-	-	-	-	-	-
Cylindre profilé HG5+ 45 x 10mm nickelé 3 clés	00058814 NS	1	-	-	-	-	-	-	-	-	-	-	-
Cylindre profilé HG5+ 50 x 10mm nickelé 3 clés	00058815 NS	1	-	-	-	-	-	-	-	-	-	-	-

NS Non stocké/Non-stored/Producto no estocado - S Sur stock Europe Zone 1 et Zone 2, nous consulter pour délai d'approvisionnement - E Epuisement/Stock depletion/Agotamiento del stock



Designation	Boîte	Colis.	Prix	Sachet	Colis.	Prix	Brochable					Colis.	Prix
							France	Euro 1	Euro 2	Euro 3	Euro 4		
Cylindre profilé HG5+ 55 x 10mm nickelé 3 clés	00058816 <small>NS</small>	1	-	-	-	-	-	-	-	-	-	-	-
Cylindre profilé HG5+ 60 x 10mm nickelé 3 clés	00058817 <small>NS</small>	1	-	-	-	-	-	-	-	-	-	-	-
Cylindre profilé HG5+ 65 x 10mm nickelé 3 clés	00058914	1	-	-	-	-	-	-	-	-	-	-	-
Cylindre profilé HG5+ 70 x 10mm nickelé 3 clés	00058818 <small>NS</small>	1	-	-	-	-	-	-	-	-	-	-	-
Cylindre profilé HG5+ 80 x 10mm nickelé 3 clés	00058819 <small>NS</small>	1	-	-	-	-	-	-	-	-	-	-	-
Cylindre profilé HG5+ 40 x 100mm nickelé 3 clés	00058826	1	-	-	-	-	-	-	-	-	-	-	-
Cylindre profilé HG5+ 90 x 10mm nickelé 3 clés	00058910	1	-	-	-	-	-	-	-	-	-	-	-
Cylindre profilé HG5+ 30 x 30mm nickelé 3 clés	00058830 <small>NS</small>	1	-	-	-	-	-	-	-	-	-	-	-
Cylindre profilé HG5+ 30 x 35mm nickelé 3 clés	00058831 <small>NS</small>	1	-	-	-	-	-	-	-	-	-	-	-
Cylindre profilé HG5+ 30 x 40mm nickelé 3 clés	00058832 <small>NS</small>	1	-	-	-	-	-	-	-	-	-	-	-
Cylindre profilé HG5+ 35 x 35mm nickelé 3 clés	00058835 <small>NS</small>	1	-	-	-	-	-	-	-	-	-	-	-
Cylindre profilé HG5+ 30 x 45mm nickelé 3 clés	00058833 <small>NS</small>	1	-	-	-	-	-	-	-	-	-	-	-
Cylindre profilé HG5+ 35 x 40mm nickelé 3 clés	00058864 <small>NS</small>	1	-	-	-	-	-	-	-	-	-	-	-
Cylindre profilé HG5+ 30 x 50mm nickelé 3 clés	00058834 <small>NS</small>	1	-	-	-	-	-	-	-	-	-	-	-
Cylindre profilé HG5+ 40 x 40mm nickelé 3 clés	00058840 <small>NS</small>	1	-	-	-	-	-	-	-	-	-	-	-
Cylindre profilé HG5+ 35 x 45mm nickelé 3 clés	00058865 <small>NS</small>	1	-	-	-	-	-	-	-	-	-	-	-
Cylindre profilé HG5+ 30 x 55mm nickelé 3 clés	00058836 <small>NS</small>	1	-	-	-	-	-	-	-	-	-	-	-
Cylindre profilé HG5+ 40 x 45mm nickelé 3 clés	00058841 <small>NS</small>	1	-	-	-	-	-	-	-	-	-	-	-
Cylindre profilé HG5+ 35 x 50mm nickelé 3 clés	00058866 <small>NS</small>	1	-	-	-	-	-	-	-	-	-	-	-
Cylindre profilé HG5+ 30 x 60mm nickelé 3 clés	00058837 <small>NS</small>	1	-	-	-	-	-	-	-	-	-	-	-
Cylindre profilé HG5+ 40 x 50mm nickelé 3 clés	00058842 <small>NS</small>	1	-	-	-	-	-	-	-	-	-	-	-
Cylindre profilé HG5+ 45 x 45mm nickelé 3 clés	00058845 <small>NS</small>	1	-	-	-	-	-	-	-	-	-	-	-
Cylindre profilé HG5+ 35 x 55mm nickelé 3 clés	00058855 <small>NS</small>	1	-	-	-	-	-	-	-	-	-	-	-
Cylindre profilé HG5+ 30 x 65mm nickelé 3 clés	00058820 <small>NS</small>	1	-	-	-	-	-	-	-	-	-	-	-
Cylindre profilé HG5+ 40 x 55mm nickelé 3 clés	00058843 <small>NS</small>	1	-	-	-	-	-	-	-	-	-	-	-





Designation	Boite	Colis.	Prix	Sachet	Colis.	Prix	Brochable					Colis.	Prix
							France	Euro 1	Euro 2	Euro 3	Euro 4		
Cylindre profilé HG5+ 45 x 50mm nickelé 3 clés	00058847 NS	1	-	-	-	-	-	-	-	-	-	-	-
Cylindre profilé HG5+ 35 x 60mm nickelé 3 clés	00058857 NS	1	-	-	-	-	-	-	-	-	-	-	-
Cylindre profilé HG5+ 30 x 70mm nickelé 3 clés	00058862 NS	1	-	-	-	-	-	-	-	-	-	-	-
Cylindre profilé HG5+ 40 x 60mm nickelé 3 clés	00058844 NS	1	-	-	-	-	-	-	-	-	-	-	-
Cylindre profilé HG5+ 45 x 55mm nickelé 3 clés	00058848 NS	1	-	-	-	-	-	-	-	-	-	-	-
Cylindre profilé HG5+ 50 x 50mm nickelé 3 clés	00058850 NS	1	-	-	-	-	-	-	-	-	-	-	-
Cylindre profilé HG5+ 40 x 65mm nickelé 3 clés	00058827	1	-	-	-	-	-	-	-	-	-	-	-
Cylindre profilé HG5+ 35 x 70mm nickelé 3 clés	00058858 NS	1	-	-	-	-	-	-	-	-	-	-	-
Cylindre profilé HG5+ 45 x 60mm nickelé 3 clés	00058849 NS	1	-	-	-	-	-	-	-	-	-	-	-
Cylindre profilé HG5+ 50 x 55mm nickelé 3 clés	00058851 NS	1	-	-	-	-	-	-	-	-	-	-	-
Cylindre profilé HG5+ 30 x 80mm nickelé 3 clés	00058863 NS	1	-	-	-	-	-	-	-	-	-	-	-
Cylindre profilé HG5+ 40 x 70mm nickelé 3 clés	00058846 NS	1	-	-	-	-	-	-	-	-	-	-	-
Cylindre profilé HG5+ 50 x 60mm nickelé 3 clés	00058852 NS	1	-	-	-	-	-	-	-	-	-	-	-
Cylindre profilé HG5+ 55 x 55mm nickelé 3 clés	00058901	1	-	-	-	-	-	-	-	-	-	-	-
Cylindre profilé HG5+ 55 x 60mm nickelé 3 clés	00058853 NS	1	-	-	-	-	-	-	-	-	-	-	-
Cylindre profilé HG5+ 45 x 70mm nickelé 3 clés	00058854 NS	1	-	-	-	-	-	-	-	-	-	-	-
Cylindre profilé HG5+ 30 x 90mm nickelé 3 clés	00058911	1	-	-	-	-	-	-	-	-	-	-	-
Cylindre profilé HG5+ 40 x 80mm nickelé 3 clés	00058828	1	-	-	-	-	-	-	-	-	-	-	-
Cylindre profilé HG5+ 50 x 70mm nickelé 3 clés	00058900	1	-	-	-	-	-	-	-	-	-	-	-
Cylindre profilé HG5+ 60 x 60mm nickelé 3 clés	00058860 NS	1	-	-	-	-	-	-	-	-	-	-	-
Cylindre profilé HG5+ 30 x 100mm nickelé 3 clés	00058912	1	-	-	-	-	-	-	-	-	-	-	-
Cylindre profilé HG5+ 40 x 90mm nickelé 3 clés	00058829	1	-	-	-	-	-	-	-	-	-	-	-
Cylindre profilé HG5+ 30 x 110mm nickelé 3 clés	00058823	1	-	-	-	-	-	-	-	-	-	-	-
Cylindre profilé HG5+ 40 x 110mm nickelé 3 clés	00058950 NS	1	-	-	-	-	-	-	-	-	-	-	-
Cylindre profilé HG5+ 30 x 120mm nickelé 3 clés	00058824	1	-	-	-	-	-	-	-	-	-	-	-



Designation	Boite	Colis.	Prix	Sachet	Colis.	Prix	Brochable					Colis.	Prix
							France	Euro 1	Euro 2	Euro 3	Euro 4		
Cylindre profilé HG5+ à bouton 30BT x 30mm nickelé 3 clés	00058867 <small>NS</small>	1	-	-	-	-	-	-	-	-	-	-	-
Cylindre profilé HG5+ à bouton 30BT x 35mm nickelé 3 clés	00058870 <small>NS</small>	1	-	-	-	-	-	-	-	-	-	-	-
Cylindre profilé HG5+ à bouton 35BT x 30mm nickelé 3 clés	00058878 <small>NS</small>	1	-	-	-	-	-	-	-	-	-	-	-
Cylindre profilé HG5+ à bouton 30BT x 40mm nickelé 3 clés	00058871 <small>NS</small>	1	-	-	-	-	-	-	-	-	-	-	-
Cylindre profilé HG5+ à bouton 35BT x 35mm nickelé 3 clés	00058882 <small>NS</small>	1	-	-	-	-	-	-	-	-	-	-	-
Cylindre profilé HG5+ à bouton 40BT x 30mm nickelé 3 clés	00058891 <small>NS</small>	1	-	-	-	-	-	-	-	-	-	-	-
Cylindre profilé HG5+ à bouton 30BT x 45mm nickelé 3 clés	00058872 <small>NS</small>	1	-	-	-	-	-	-	-	-	-	-	-
Cylindre profilé HG5+ à bouton 35BT x 40mm nickelé 3 clés	00058883 <small>NS</small>	1	-	-	-	-	-	-	-	-	-	-	-
Cylindre profilé HG5+ à bouton 40BT x 35mm nickelé 3 clés	00058892 <small>NS</small>	1	-	-	-	-	-	-	-	-	-	-	-
Cylindre profilé HG5+ 40 x 10mm nickelé 3 clés	00058813 <small>NS</small>	1	-	-	-	-	-	-	-	-	-	-	-
Cylindre profilé HG5+ à bouton 30BT x 50mm nickelé 3 clés	00058873 <small>NS</small>	1	-	-	-	-	-	-	-	-	-	-	-
Cylindre profilé HG5+ à bouton 35BT x 45mm nickelé 3 clés	00058884 <small>NS</small>	1	-	-	-	-	-	-	-	-	-	-	-
Cylindre profilé HG5+ à bouton 40BT x 40mm nickelé 3 clés	00058893 <small>NS</small>	1	-	-	-	-	-	-	-	-	-	-	-
Cylindre profilé HG5+ à bouton 45BT x 35mm nickelé 3 clés	00058868	1	-	-	-	-	-	-	-	-	-	-	-
Cylindre profilé HG5+ à bouton 50BT x 30mm nickelé 3 clés	00058917	1	-	-	-	-	-	-	-	-	-	-	-
Cylindre profilé HG5+ à bouton 30BT x 55mm nickelé 3 clés	00058874 <small>NS</small>	1	-	-	-	-	-	-	-	-	-	-	-
Cylindre profilé HG5+ à bouton 35BT x 50mm nickelé 3 clés	00058885 <small>NS</small>	1	-	-	-	-	-	-	-	-	-	-	-
Cylindre profilé HG5+ à bouton 40BT x 45mm nickelé 3 clés	00058894 <small>NS</small>	1	-	-	-	-	-	-	-	-	-	-	-





Designation	Boite	Colis.	Prix	Sachet	Colis.	Prix	Brochable					Colis.	Prix
							France	Euro 1	Euro 2	Euro 3	Euro 4		
Cylindre profilé HG5+ à bouton 45BT x 40mm nickelé 3 clés	00058915	1	-		-	-	-	-	-	-	-	-	-
Cylindre profilé HG5+ à bouton 50BT x 35mm nickelé 3 clés	00058918	1	-		-	-	-	-	-	-	-	-	-
Cylindre profilé HG5+ à bouton 30BT x 60mm nickelé 3 clés	00058875 NS	1	-	-	-	-	-	-	-	-	-	-	-
Cylindre profilé HG5+ à bouton 35BT x 55mm nickelé 3 clés	00058886 NS	1	-	-	-	-	-	-	-	-	-	-	-
Cylindre profilé HG5+ à bouton 40BT x 50mm nickelé 3 clés	00058895 NS	1	-	-	-	-	-	-	-	-	-	-	-
Cylindre profilé HG5+ à bouton 45BT x 45mm nickelé 3 clés	00058916	1	-		-	-	-	-	-	-	-	-	-
Cylindre profilé HG5+ à bouton 50BT x 40mm nickelé 3 clés	00058920	1	-		-	-	-	-	-	-	-	-	-
Cylindre profilé HG5+ à bouton 60BT x 30mm nickelé 3 clés	00058902	1	-		-	-	-	-	-	-	-	-	-
Cylindre profilé HG5+ à bouton 30BT x 65mm nickelé 3 clés	00058876 NS	1	-	-	-	-	-	-	-	-	-	-	-
Cylindre profilé HG5+ à bouton 35BT x 60mm nickelé 3 clés	00058887 NS	1	-	-	-	-	-	-	-	-	-	-	-
Cylindre profilé HG5+ à bouton 40BT x 55mm nickelé 3 clés	00058897 NS	1	-	-	-	-	-	-	-	-	-	-	-
Cylindre profilé HG5+ à bouton 30BT x 70mm nickelé 3 clés	00058877 NS	1	-	-	-	-	-	-	-	-	-	-	-
Cylindre profilé HG5+ à bouton 40BT x 60mm nickelé 3 clés	00058898 NS	1	-	-	-	-	-	-	-	-	-	-	-
Cylindre profilé HG5+ à bouton 50BT x 50mm nickelé 3 clés	00058921	1	-		-	-	-	-	-	-	-	-	-
Cylindre profilé HG5+ à bouton 60BT x 40mm nickelé 3 clés	00058903	1	-		-	-	-	-	-	-	-	-	-
Cylindre profilé HG5+ à bouton 70BT x 30mm nickelé 3 clés	00058905	1	-		-	-	-	-	-	-	-	-	-
Cylindre profilé HG5+ à bouton 35BT x 70mm nickelé 3 clés	00058888 NS	1	-	-	-	-	-	-	-	-	-	-	-

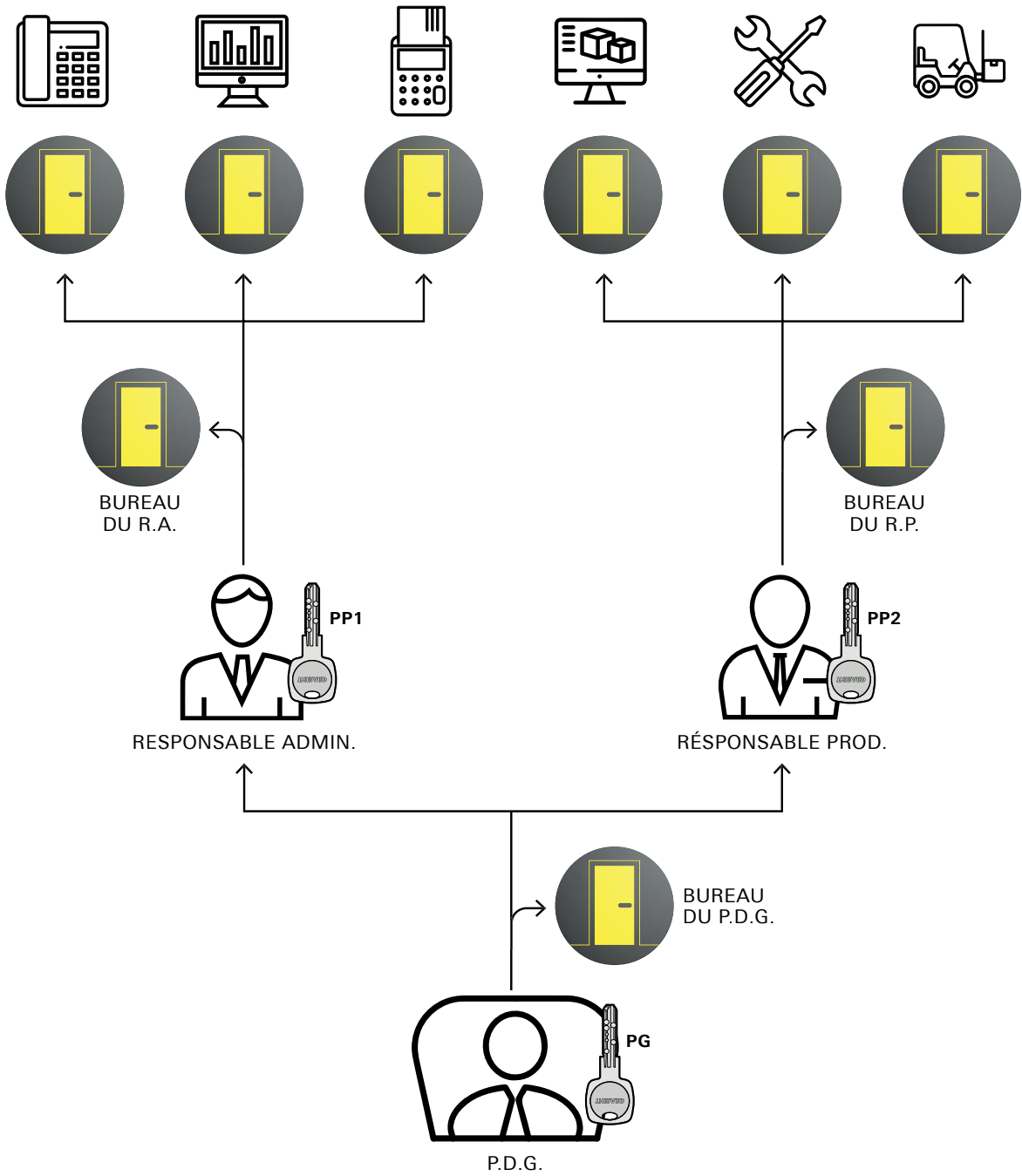

Cylindre de sûreté / HG6+

PROTECT



NIVEAU DE SÉCURITÉ



GARANTIE



X 5



Système breveté avec billes de sécurité mobile



Protection Arrachement



Protection Perçage



Protection Crochetage



Protection Casse



Protection Snap

Description/Description/Descripción

Profil européen laiton. Mécanisme à 6 goupilles.
 Protection contre le perçage par 1ère goupille + poussoir en acier trempé. Protection contre la casse par cavalier acier. Protection contre leffraction de la partie saillante du cylindre (anti-snap). Panneton anti arrachement. 5 clés laiton nickelé avec carte de propriété permettant la reproduction des clés. exclusivement en usine. Billes anti-crochetage interne au cylindre interdisant toute reproduction hors usine. Option : Aiguille anti-perçage.
European brass profile. 6 pins mechanism. Protection against drilling by hardened steel pins. Protection against breakage by steel bridge. Protection against the intrusion of the projecting portion of the cylinder (anti-snap). Driver cam made of powdered metal. 5 nickel plated brass patented keys with personal security card for key copies. Balls anti-picking internal cylinder prohibiting any reproduction. Option : anti-drill pin.

Perfil europeo de latón. Mecanismo de 6 pistones. Protección contra el taladrado mediante un pasador y un empujador de acero templado. Protección contra rotura de puente de acero. Protección contra la manipulación de la parte saliente de cilindro. Pivote de acero sinterizado antiarrancamiento. 5 llaves de latón niquelado patentadas con título de propiedad que permite su reproducción únicamente en fábrica. Bolas anti-forzado internas al cilindro que prohíben cualquier reproducción fuera de fábrica. Opción: Aguja antitaladrado.

Finition/Finish/Acabado

Nickelé / Nickel plated / Níquelado

Version/Option/Versión

Possibilité de montage avec panneton débrayable. Panneton orientable pour la dimension 30 x 10. Possibilité de montage avec bouton débrayable. Emergency function. With ajustable driver cam for 30x10. Posibilidad de montaje con sistema de emergencia. Paletón orientable para el dimension 30x10.

Designation	Boite	Colis.	Prix	Sachet	Colis.	Prix	Brochable					Colis.	Prix
							France	Euro 1	Euro 2	Euro 3	Euro 4		
Cylindre HG6+ - 31x10mm nickelé panneton orientable 5 clés	00076160 	1	-	-	-	-	-	-	-	-	-	-	-
Cylindre HG6+ - 61x10mm nickelé panneton orientable 5 clés	00076166 	1	-	-	-	-	-	-	-	-	-	-	-

Non stocké/Non-stored/Producto no estocado - Sur stock Europe Zone 1 et Zone 2, nous consulter pour délai d'approvisionnement - Epuisement/Stock depletion/Agotamiento del stock

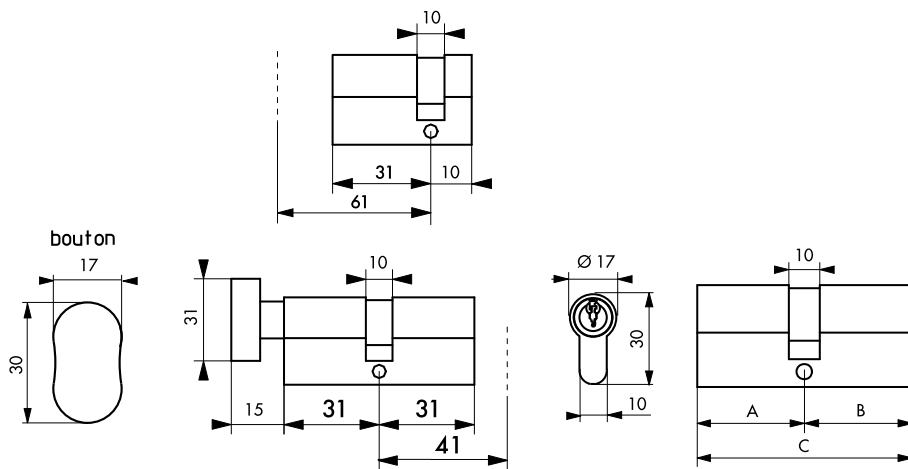

	31x31	36x36	41x41	31x41	31x51	31x61	31x66	36x46
A	31	36	41	31	31	31	31	36
B	31	36	41	41	51	61	66	46
C	62	72	82	72	82	92	97	82

Designation	Boite	Colis.	Prix	Sachet	Colis.	Prix	Brochable					Colis.	Prix
							France	Euro 1	Euro 2	Euro 3	Euro 4		
Cylindre HG6+ - 31x31mm nickelé panneton orientable 5 clés	00076175 <small>NS</small>	1	-	-	-	-	-	-	-	-	-	-	-
Cylindre HG6+ - 36x36mm nickelé panneton orientable 5 clés	00076191 <small>NS</small>	1	-	-	-	-	-	-	-	-	-	-	-
Cylindre HG6+ - 41x41mm nickelé panneton orientable 5 clés	00076207 <small>NS</small>	1	-	-	-	-	-	-	-	-	-	-	-
Cylindre HG6+ - 31x41mm nickelé panneton orientable 5 clés	00076177 <small>NS</small>	1	-	-	-	-	-	-	-	-	-	-	-
Cylindre HG6+ - 31x51mm nickelé panneton orientable 5 clés	00076179 <small>NS</small>	1	-	-	-	-	-	-	-	-	-	-	-
Cylindre HG6+ - 31x61mm nickelé panneton orientable 5 clés	00076181 <small>NS</small>	1	-	-	-	-	-	-	-	-	-	-	-
Cylindre HG6+ - 31x66mm nickelé panneton orientable 5 clés	00076182 <small>NS</small>	1	-	-	-	-	-	-	-	-	-	-	-
Cylindre HG6+ - 36x46mm nickelé panneton orientable 5 clés	00076193 <small>NS</small>	1	-	-	-	-	-	-	-	-	-	-	-
Cylindre HG6+ - 31BTx31mm nickelé panneton orientable 5 clés	00076340 <small>NS</small>	1	-	-	-	-	-	-	-	-	-	-	-
Cylindre HG6+ - 31BTx41mm nickelé panneton orientable 5 clés	00076342 <small>NS</small>	1	-	-	-	-	-	-	-	-	-	-	-



Cylindre de haute sûreté / ADRIATIC 2

PROTECT



NIVEAU DE SÉCURITÉ



GARANTIE



X 5

Système breveté avec billes de sécurité mobile



Protection Arrachement



Protection Perçage



Protection Crochetage



Protection Casse



Protection Snap

Description/Description/Descripción

Profil européen laiton. Mécanisme de 6 à 14 goupilles. Protection contre le perçage par 1ère goupille + poussoir en acier trempé. Protection contre la casse par cavalier acier. Protection contre leffraction de la partie saillante du cylindre (anti-snap). Panneton anti arrachement. 5 clés laiton nickelé avec carte de propriété permettant la reproduction des clés. exclusivement en usine. Billes anti-crochetage interne au cylindre interdisant toute reproduction hors usine. Option : Aiguille anti-perçage. *European brass profile. 6 to 14 pins mechanism. Protection against drilling by hardened steel pins. Protection against breakage by steel bridge. Protection against the intrusion of the projecting portion of the cylinder (anti-snap). Driver cam made of powdered metal. 5 nickel plated brass patented keys with personal security card for key copies. Balls anti-picking internal cylinder prohibiting any reproduction. Option : anti-drill pin.*

Perfil europeo de latón. Mecanismo de 6 a 14 pistones. Protección contra el taladrado mediante un pasador

et un empousoir de acero templado. Protección contra rotura de puente de acero. Protección contra la manipulación de la parte saliente de cilindro. Pivote de acero sinterizado antiarrancamiento. 5 llaves de latón niqueladas patentadas con título de propiedad que permite su reproducción únicamente en fábrica. Bolas anti-forzado internas al cilindro que prohíben cualquier reproducción fuera de fábrica. Opción: Aguja antitaladrado.

Finition/Finish/Acabado

Nickelelé mat
Dull nickel plated.
Níquelelado mate

Versión/Option/Versión

Possibilité de montage avec panneton débrayable Panneton orientable pour la dimension 31 x 10. Possibilité de montage avec bouton débrayable. *Emergency function. With ajustable driver cam for 31x10.* Posibilidad de montaje con sistema de emergencia. Paletón orientable para el dimension 31x10.

Cylindre de haute sûreté / ADRIATIC 2

PROTECT



NIVEAU DE SÉCURITÉ

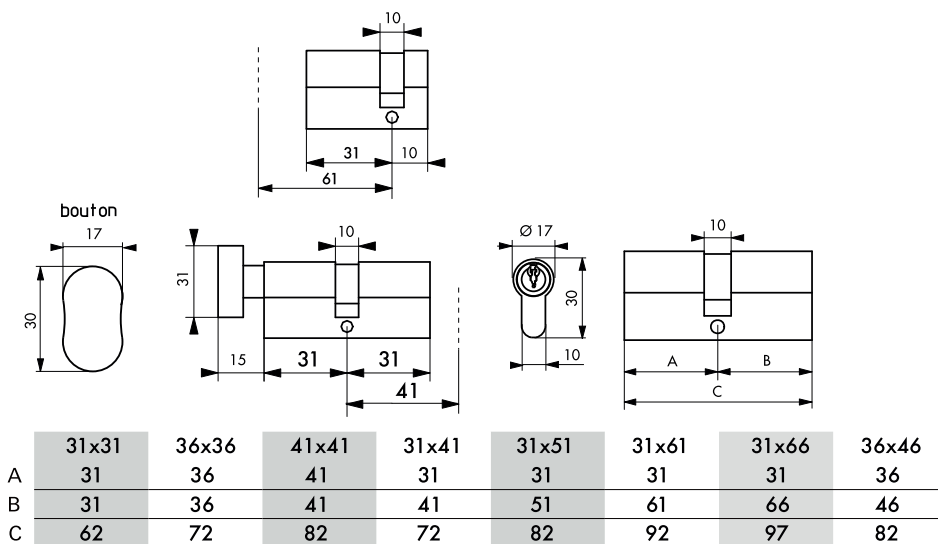

Designation	Boite	Colis.	Prix	Sachet	Colis.	Prix	Brochable					Colis.	Prix
							France	Euro 1	Euro 2	Euro 3	Euro 4		
Demi-cylindre profilé ADRIATIC 2 31 mm pour cadenas 720 CP	00049312 <small>NS</small>	1	-	-	-	-	-	-	-	-	-	-	-
Demi-cylindre profilé ADRIATIC 2 31 x 10mm nickelé panneton orientable 5 clés	00067640 <small>NS</small>	1	-	-	-	-	-	-	-	-	-	-	-
Demi-cylindre profilé ADRIATIC 2 61 x 10mm nickelé panneton orientable 5 clés	00067646 <small>NS</small>	1	-	-	-	-	-	-	-	-	-	-	-
Cylindre profilé ADRIATIC 2 31 x 31mm nickelé 5 clés	00067655 <small>NS</small>	1	-	-	-	-	-	-	-	-	-	-	-
Cylindre profilé ADRIATIC 2 36 x 36mm nickelé 5 clés	00067671 <small>NS</small>	1	-	-	-	-	-	-	-	-	-	-	-
Cylindre profilé ADRIATIC 2 41 x 41mm nickelé 5 clés	00067687 <small>NS</small>	1	-	-	-	-	-	-	-	-	-	-	-
Cylindre profilé ADRIATIC 2 31 x 41mm nickelé 5 clés	00067657 <small>NS</small>	1	-	-	-	-	-	-	-	-	-	-	-
Cylindre profilé ADRIATIC 2 31 x 51mm nickelé 5 clés	00067659 <small>NS</small>	1	-	-	-	-	-	-	-	-	-	-	-
Cylindre profilé ADRIATIC 2 31 x 61mm nickelé 5 clés	00067661 <small>NS</small>	1	-	-	-	-	-	-	-	-	-	-	-
Cylindre profilé ADRIATIC 2 31 x 66mm nickelé 5 clés	00067662 <small>NS</small>	1	-	-	-	-	-	-	-	-	-	-	-
Cylindre profilé ADRIATIC 2 36 x 46mm nickelé 5 clés	00067673 <small>NS</small>	1	-	-	-	-	-	-	-	-	-	-	-
Cylindre profilé ADRIATIC 2 à bouton 31BT x 31mm nickelé 5 clés	00067820 <small>NS</small>	1	-	-	-	-	-	-	-	-	-	-	-
Cylindre profilé ADRIATIC 2 à bouton 31BT x 41mm nickelé 5 clés	00067822 <small>NS</small>	1	-	-	-	-	-	-	-	-	-	-	-

NS Non stocké/Non-stored/Productos no estocados - ■ Sur stock Europe Zone 1 et Zone 2, nous consulter pour délai d'approvisionnement - E Epuement/Stock depletion/Agotamiento del stock



Cylindre de haute sûreté / ADRIA POUR ORGANIGRAMME

PROTECT



NIVEAU DE SÛRETÉ



GARANTIE



Système breveté avec piston de sécurité mobile



X 3



Protection Arrachement



Protection Perçage



Protection Crochetage

Description/Description/Descripción

Profil européen laiton. Mécanisme à 5 goupilles. Protection contre le perçage par 1ère goupille + poussoir en acier trempé. Panneton anti arrachement. 3 clés plates maillechort avec carte de propriété permettant la reproduction des clés exclusivement en usine. Pièce mobile anti-crochetage interne au cylindre interdisant toute reproduction hors usine. Option : Aiguille anti-perçage.

European brass profile. 5 pins mechanism. Protection against drilling by hardened steel pins. Driver cam made of powdered metal. 3 nickel silver patented keys with personal security card for key copies. Internal moving parts anti-picking cylinder prohibiting any reproduction. Option : anti-drill pin.

Perfil europeo de latón. Mecanismo de 5 pistones. Protección contra el taladrado mediante un pasador y un empujador de acero templado. Pivote de acero sinterizado antiar-rancamiento. 3 llaves planas de alpaca reversibles patentadas con título de propiedad que permite su reproducción únicamente en fábrica. Opción: Aguja antitaladrado.

Finition/Finish/Acabado

Nickel velours / Dull nickel plated / Níquel terciopelo

Version/Option/Versión

Demi-cylindre. Cylindre 2 entrées. Cylindre à bouton 1 entrée. Possibilité de montage avec panneton débrayable. Panneton orientable pour les dimensions 30 x 10 et 35 x 10. (autres dimensions sur demande). Point Service disponible. Possibilité de montage avec bouton débrayable.

1/2 cylinder with key way. Cylinder with 2 key ways. Cylinder with key way and inside knob. Emergency function. With adjustable driver cam for 30x10 and 35x10 (other dimensions on request).

Semicilindro. Cilindro de 2 entradas. Cilindro de botón de 1 entrada. Posibilidad de montaje con sistema de emergencia. Paletón orientable para las dimensiones 30x10 y 35x10 (otras dimensiones sobre demanda).

Utilisation/Use/Utilización

Exclusivement pour système organigramme

Exclusively for master key system

Exclusivamente para sistema organigrama

Designation	Boite	Colis.	Prix	Sachet	Colis.	Prix	Brochable					Colis.	Prix
							France	Euro 1	Euro 2	Euro 3	Euro 4		
Cylindre ADRIA 30 x 30 mm nickelé 3 clés	00047330 NS	1	-	-	-	-	-	-	-	-	-	-	-
Cylindre ADRIA 35 x 35 mm nickelé 3 clés	00033535 NS	1	-	-	-	-	-	-	-	-	-	-	-
Cylindre ADRIA 40 x 40 mm nickelé 3 clés	00047440 NS	1	-	-	-	-	-	-	-	-	-	-	-
Cylindre ADRIA 45 x 45 mm nickelé 3 clés	00034545 NS	1	-	-	-	-	-	-	-	-	-	-	-

NS Non stocké/Non-stored/Producto no estocado - ☑ Sur stock Europe Zone 1 et Zone 2, nous consulter pour délai d'approvisionnement - ☒ Epuisement/Stock depletion/Agotamiento del stock

Designation	Boite	Colis.	Prix	Sachet	Colis.	Prix	Brochable					Colis.	Prix
							France	Euro 1	Euro 2	Euro 3	Euro 4		
Cylindre ADRIA 50 x 50 mm nickelé 3 clés	00047550 <small>NS</small>	1	-	-	-	-	-	-	-	-	-	-	-
Cylindre ADRIA 55 x 55 mm nickelé 3 clés	00035555 <small>NS</small>	1	-	-	-	-	-	-	-	-	-	-	-
Cylindre ADRIA 60 x 60 mm nickelé 3 clés	00036060 <small>NS</small>	1	-	-	-	-	-	-	-	-	-	-	-
Cylindre ADRIA 30 x 35 mm nickelé 3 clés	00047335 <small>NS</small>	1	-	-	-	-	-	-	-	-	-	-	-
Cylindre ADRIA 30 x 40 mm nickelé 3 clés	00047340 <small>NS</small>	1	-	-	-	-	-	-	-	-	-	-	-
Cylindre ADRIA 30 x 45 mm nickelé 3 clés	00047345 <small>NS</small>	1	-	-	-	-	-	-	-	-	-	-	-
Cylindre ADRIA 30 x 50 mm nickelé 3 clés	00047350 <small>NS</small>	1	-	-	-	-	-	-	-	-	-	-	-
Cylindre ADRIA 30 x 55 mm nickelé 3 clés	00047355 <small>NS</small>	1	-	-	-	-	-	-	-	-	-	-	-
Cylindre ADRIA 30 x 60 mm nickelé 3 clés	00047360 <small>NS</small>	1	-	-	-	-	-	-	-	-	-	-	-
Cylindre ADRIA 30 x 65 mm nickelé 3 clés	00047365 <small>NS</small>	1	-	-	-	-	-	-	-	-	-	-	-
Cylindre ADRIA 30 x 70 mm nickelé 3 clés	00047370 <small>NS</small>	1	-	-	-	-	-	-	-	-	-	-	-
Cylindre ADRIA 30 x 80 mm nickelé 3 clés	00047380 <small>NS</small>	1	-	-	-	-	-	-	-	-	-	-	-
Cylindre ADRIA 35 x 40 mm nickelé 3 clés	00033540 <small>NS</small>	1	-	-	-	-	-	-	-	-	-	-	-
Cylindre ADRIA 35 x 45 mm nickelé 3 clés	00033545 <small>NS</small>	1	-	-	-	-	-	-	-	-	-	-	-
Cylindre ADRIA 35 x 50 mm nickelé 3 clés	00033550 <small>NS</small>	1	-	-	-	-	-	-	-	-	-	-	-
Cylindre ADRIA 35 x 55 mm nickelé 3 clés	00033555 <small>NS</small>	1	-	-	-	-	-	-	-	-	-	-	-
Cylindre ADRIA 35 x 60 mm nickelé 3 clés	00033560 <small>NS</small>	1	-	-	-	-	-	-	-	-	-	-	-
Cylindre ADRIA 35 x 70 mm nickelé 3 clés	00033570 <small>NS</small>	1	-	-	-	-	-	-	-	-	-	-	-
Cylindre ADRIA 40 x 45 mm nickelé 3 clés	00047445 <small>NS</small>	1	-	-	-	-	-	-	-	-	-	-	-
Cylindre ADRIA 40 x 50 mm nickelé 3 clés	00047450 <small>NS</small>	1	-	-	-	-	-	-	-	-	-	-	-
Cylindre ADRIA 40 x 55 mm nickelé 3 clés	00047455 <small>NS</small>	1	-	-	-	-	-	-	-	-	-	-	-
Cylindre ADRIA 40 x 60 mm nickelé 3 clés	00047460 <small>NS</small>	1	-	-	-	-	-	-	-	-	-	-	-
Cylindre ADRIA 40 x 70 mm nickelé 3 clés	00047470 <small>NS</small>	1	-	-	-	-	-	-	-	-	-	-	-
Cylindre ADRIA 45 x 50 mm nickelé 3 clés	00034550 <small>NS</small>	1	-	-	-	-	-	-	-	-	-	-	-
Cylindre ADRIA 45 x 55 mm nickelé 3 clés	00034555 <small>NS</small>	1	-	-	-	-	-	-	-	-	-	-	-
Cylindre ADRIA 45 x 60 mm nickelé 3 clés	00034560 <small>NS</small>	1	-	-	-	-	-	-	-	-	-	-	-
Cylindre ADRIA 45 x 70 mm nickelé 3 clés	00034570 <small>NS</small>	1	-	-	-	-	-	-	-	-	-	-	-
Cylindre ADRIA 50 x 55 mm nickelé 3 clés	00047555 <small>NS</small>	1	-	-	-	-	-	-	-	-	-	-	-
Cylindre ADRIA 50 x 60 mm nickelé 3 clés	00047560 <small>NS</small>	1	-	-	-	-	-	-	-	-	-	-	-
Cylindre ADRIA 55 x 60 mm nickelé 3 clés	00035560 <small>NS</small>	1	-	-	-	-	-	-	-	-	-	-	-

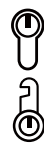

Cylindre de haute sûreté / ADRIATIC POUR ORGANIGRAMME PROTECT



Système breveté avec piston de sécurité mobile. Compatible avec ADRIA



NIVEAU DE SÉCURITÉ



GARANTIE



X 3



Protection Arrachement



Protection Perçage



Protection Crochetage

Description/Description/Descripción

Profil européen laiton. Mécanisme de 6 à 22 goupilles maillechort sur 5 rangées. Protection contre le perçage par 1ère goupille + poussoir en acier trempé. Panneton anti arrachement. 3 clés plates maillechort avec insert ABS avec carte de propriété permettant la reproduction des clés. exclusivement en usine. Pièce mobile anti-crochetage interne au cylindre interdisant toute reproduction hors usine.

European brass profile. 6 to 22 nickel silver pin mechanism. Protection against drilling by hardened steel pins. Driver cam made of powdered metal. 3 reversible nickel silver patented keys with personal security card for key copies.

Perfil europeo de latón. Mecanismo de 6 a 22 pistones de alpaca. Protección contra el taladrado por medio de un pasador de acero templado. Pivote de acero sinterizado antiarrancamiento. 3 llaves planas de alpaca reversibles patentadas con título de propiedad que permite su reproducción únicamente en fábrica.

Finition/Finish/Acabado

Nickel velours

Dull nickel plated

Níquel terciopelo

Version/Option/Versión

Demi-cylindre. Cylindre 2 entrées. Cylindre à bouton 1 entrée. Possibilité de montage avec panneton débrayable. Panneton orientable pour la dimension 30x10 et 35x10 (autres dimensions sur demande). Point Service disponible. Possibilité de montage avec bouton débrayable.

1/2 cylinder with key way. Cylinder with 2 key ways. Cylinder with key way and inside knob.

Emergencyfunction. With adjustable driver cam for 30x10 and 35x10 (other dimensions on request)

Semicilindro. Cilindro de 2 entradas. Cilindro de botón de 1 entrada. Posibilidad de montaje con sistema de emergencia. Paletón orientable para el dimension 30x10 y 35x10 (otras dimensiones sobre demanda).

Utilisation/Use/Utilización

Exclusivement pour système organigramme

Exclusively for master key system

Exclusivamente para sistema organigrama

Designation	Boite	Colis.	Prix	Sachet	Colis.	Prix	Brochable					Colis.	Prix
							France	Euro 1	Euro 2	Euro 3	Euro 4		
Cylindre ADRIATIC 30 x 30 mm nickelé 3 clés	00049330 NS	1	-	-	-	-	-	-	-	-	-	-	-
Cylindre ADRIATIC 35 x 35 mm nickelé 3 clés	00043535 NS	1	-	-	-	-	-	-	-	-	-	-	-

NS Non stocké/Non-stored/Producto no estocado - S Sur stock Europe Zone 1 et Zone 2, nous consulter pour délai d'approvisionnement - E Epuisement/Stock depletion/Agotamiento del stock

Cylindre de haute sûreté / ADRIATIC POUR ORGANIGRAMME

PROTECT



NIVEAU DE SÉCURITÉ



Designation	Boîte	Colis.	Prix	Sachet	Colis.	Prix	Brochable					Colis.	Prix
							France	Euro 1	Euro 2	Euro 3	Euro 4		
Cylindre ADRIATIC 40 x 40 mm nickelé 3 clés	00049440 <small>NS</small>	1	-	-	-	-	-	-	-	-	-	-	-
Cylindre ADRIATIC 45 x 45 mm nickelé 3 clés	00044545 <small>NS</small>	1	-	-	-	-	-	-	-	-	-	-	-
Cylindre ADRIATIC 50 x 50 mm nickelé 3 clés	00049550 <small>NS</small>	1	-	-	-	-	-	-	-	-	-	-	-
Cylindre ADRIATIC 55 x 55 mm nickelé 3 clés	00045555 <small>NS</small>	1	-	-	-	-	-	-	-	-	-	-	-
Cylindre ADRIATIC 60 x 60 mm nickelé 3 clés	00046060 <small>NS</small>	1	-	-	-	-	-	-	-	-	-	-	-
Cylindre ADRIATIC 30 x 35 mm nickelé 3 clés	00049335 <small>NS</small>	1	-	-	-	-	-	-	-	-	-	-	-
Cylindre ADRIATIC 30 x 40 mm nickelé 3 clés	00049340 <small>NS</small>	1	-	-	-	-	-	-	-	-	-	-	-
Cylindre ADRIATIC 30 x 45 mm nickelé 3 clés	00049345 <small>NS</small>	1	-	-	-	-	-	-	-	-	-	-	-
Cylindre ADRIATIC 30 x 50 mm nickelé 3 clés	00049350 <small>NS</small>	1	-	-	-	-	-	-	-	-	-	-	-
Cylindre ADRIATIC 30 x 55 mm nickelé 3 clés	00049355 <small>NS</small>	1	-	-	-	-	-	-	-	-	-	-	-
Cylindre ADRIATIC 30 x 60 mm nickelé 3 clés	00049360 <small>NS</small>	1	-	-	-	-	-	-	-	-	-	-	-
Cylindre ADRIATIC 30 x 65 mm nickelé 3 clés	00049365 <small>NS</small>	1	-	-	-	-	-	-	-	-	-	-	-
Cylindre ADRIATIC 30 x 70 mm nickelé 3 clés	00049370 <small>NS</small>	1	-	-	-	-	-	-	-	-	-	-	-
Cylindre ADRIATIC 30 x 80 mm nickelé 3 clés	00049380 <small>NS</small>	1	-	-	-	-	-	-	-	-	-	-	-
Cylindre ADRIATIC 35 x 40 mm nickelé 3 clés	00043540 <small>NS</small>	1	-	-	-	-	-	-	-	-	-	-	-
Cylindre ADRIATIC 35 x 45 mm nickelé 3 clés	00043545 <small>NS</small>	1	-	-	-	-	-	-	-	-	-	-	-
Cylindre ADRIATIC 35 x 50 mm nickelé 3 clés	00043550 <small>NS</small>	1	-	-	-	-	-	-	-	-	-	-	-
Cylindre ADRIATIC 35 x 55 mm nickelé 3 clés	00043555 <small>NS</small>	1	-	-	-	-	-	-	-	-	-	-	-
Cylindre ADRIATIC 35 x 60 mm nickelé 3 clés	00043560 <small>NS</small>	1	-	-	-	-	-	-	-	-	-	-	-
Cylindre ADRIATIC 35 x 70 mm nickelé 3 clés	00043570 <small>NS</small>	1	-	-	-	-	-	-	-	-	-	-	-
Cylindre ADRIATIC 40 x 45 mm nickelé 3 clés	00049445 <small>NS</small>	1	-	-	-	-	-	-	-	-	-	-	-
Cylindre ADRIATIC 40 x 50 mm nickelé 3 clés	00049450 <small>NS</small>	1	-	-	-	-	-	-	-	-	-	-	-
Cylindre ADRIATIC 40 x 55 mm nickelé 3 clés	00049455 <small>NS</small>	1	-	-	-	-	-	-	-	-	-	-	-
Cylindre ADRIATIC 40 x 60 mm nickelé 3 clés	00049460 <small>NS</small>	1	-	-	-	-	-	-	-	-	-	-	-
Cylindre ADRIATIC 40 x 70 mm nickelé 3 clés	00049470 <small>NS</small>	1	-	-	-	-	-	-	-	-	-	-	-
Cylindre ADRIATIC 45 x 50 mm nickelé 3 clés	00044550 <small>NS</small>	1	-	-	-	-	-	-	-	-	-	-	-
Cylindre ADRIATIC 45 x 55 mm nickelé 3 clés	00044555 <small>NS</small>	1	-	-	-	-	-	-	-	-	-	-	-

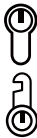

NS Non stocké/Non-stored/Productos no estocados - ■ Sur stock Europe Zone 1 et Zone 2, nous consulter pour délai d'approvisionnement - E Epuement/Stock depletion/Agotamiento del stock

Cylindre de haute sûreté / ADRIATIC POUR ORGANIGRAMME

PROTECT



NIVEAU DE SÉCURITÉ



Designation	Boite	Colis.	Prix	Sachet	Colis.	Prix	Brochable					Colis.	Prix
							France	Euro 1	Euro 2	Euro 3	Euro 4		
Cylindre ADRIATIC 45 x 60 mm nickelé 3 clés	00044560 NS	1	-	-	-	-	-	-	-	-	-	-	-
Cylindre ADRIATIC 45 x 70 mm nickelé 3 clés	00044570 NS	1	-	-	-	-	-	-	-	-	-	-	-
Cylindre ADRIATIC 50 x 55 mm nickelé 3 clés	00049555 NS	1	-	-	-	-	-	-	-	-	-	-	-
Cylindre ADRIATIC 50 x 60 mm nickelé 3 clés	00049560 NS	1	-	-	-	-	-	-	-	-	-	-	-
Cylindre ADRIATIC 55 x 60 mm nickelé 3 clés	00045560 NS	1	-	-	-	-	-	-	-	-	-	-	-
Demi-cylindre ADRIATIC 30 x 10 mm nickelé panneton orientable 3 clés	00049301 NS	1	-	-	-	-	-	-	-	-	-	-	-
Demi-cylindre ADRIATIC 35 x 10 mm nickelé panneton orientable 3 clés	00049351 NS	1	-	-	-	-	-	-	-	-	-	-	-
Demi-cylindre ADRIATIC 40 x 10 mm nickelé 3 clés	00049401 NS	1	-	-	-	-	-	-	-	-	-	-	-
Demi-cylindre ADRIATIC 45 x 10 mm nickelé 3 clés	00049451 NS	1	-	-	-	-	-	-	-	-	-	-	-
Demi-cylindre ADRIATIC 50 x 10 mm nickelé 3 clés	00049501 NS	1	-	-	-	-	-	-	-	-	-	-	-
Demi-cylindre ADRIATIC 55 x 10 mm nickelé 3 clés	00049551 NS	1	-	-	-	-	-	-	-	-	-	-	-
Demi-cylindre ADRIATIC 60 x 10 mm nickelé 3 clés	00049601 NS	1	-	-	-	-	-	-	-	-	-	-	-
Demi-cylindre ADRIATIC 70 x 10 mm nickelé 3 clés	00049701 NS	1	-	-	-	-	-	-	-	-	-	-	-
Demi-cylindre ADRIATIC 80 x 10 mm nickelé 3 clés	00049801 NS	1	-	-	-	-	-	-	-	-	-	-	-
Cylindre ADRIATIC à bouton 30 x 30 mm nickelé 3 clés	00048330 NS	1	-	-	-	-	-	-	-	-	-	-	-
Cylindre ADRIATIC à bouton 30 x 35 mm nickelé 3 clés	00048335 NS	1	-	-	-	-	-	-	-	-	-	-	-
Cylindre ADRIATIC à bouton 30 x 40 mm nickelé 3 clés	00048340 NS	1	-	-	-	-	-	-	-	-	-	-	-
Cylindre ADRIATIC à bouton 30 x 45 mm nickelé 3 clés	00048345 NS	1	-	-	-	-	-	-	-	-	-	-	-
Cylindre ADRIATIC à bouton 30 x 50 mm nickelé 3 clés	00048350 NS	1	-	-	-	-	-	-	-	-	-	-	-
Cylindre ADRIATIC à bouton 30 x 55 mm nickelé 3 clés	00048355 NS	1	-	-	-	-	-	-	-	-	-	-	-
Cylindre ADRIATIC à bouton 30 x 60 mm nickelé 3 clés	00048360 NS	1	-	-	-	-	-	-	-	-	-	-	-
Cylindre ADRIATIC à bouton 30 x 65 mm nickelé 3 clés	00048365 NS	1	-	-	-	-	-	-	-	-	-	-	-
Cylindre ADRIATIC à bouton 30 x 70 mm nickelé 3 clés	00048370 NS	1	-	-	-	-	-	-	-	-	-	-	-
Cylindre ADRIATIC à bouton 35 x 30 mm nickelé 3 clés	00048530 NS	1	-	-	-	-	-	-	-	-	-	-	-
Cylindre ADRIATIC à bouton 35 x 35 mm nickelé 3 clés	00048535 NS	1	-	-	-	-	-	-	-	-	-	-	-
Cylindre ADRIATIC à bouton 35 x 40 mm nickelé 3 clés	00048540 NS	1	-	-	-	-	-	-	-	-	-	-	-

NS Non stocké/Non-stored/Producto no estocado - ☐ Sur stock Europe Zone 1 et Zone 2, nous consulter pour délai d'approvisionnement - ☒ Epuisement/Stock depletion/Agotamiento del stock

Cylindre de haute sûreté / ADRIATIC POUR ORGANIGRAMME

PROTECT



NIVEAU DE SÉCURITÉ



Designation	Boite	Colis.	Prix	Sachet	Colis.	Prix	Brochable					Colis.	Prix
							France	Euro 1	Euro 2	Euro 3	Euro 4		
Cylindre ADRIATIC à bouton 35 x 45 mm nickelé 3 clés	00048545 <small>NS</small>	1	-	-	-	-	-	-	-	-	-	-	-
Cylindre ADRIATIC à bouton 35 x 50 mm nickelé 3 clés	00048550 <small>NS</small>	1	-	-	-	-	-	-	-	-	-	-	-
Cylindre ADRIATIC à bouton 35 x 55 mm nickelé 3 clés	00048555 <small>NS</small>	1	-	-	-	-	-	-	-	-	-	-	-
Cylindre ADRIATIC à bouton 35 x 60 mm nickelé 3 clés	00048560 <small>NS</small>	1	-	-	-	-	-	-	-	-	-	-	-
Cylindre ADRIATIC à bouton 35 x 70 mm nickelé 3 clés	00048570 <small>NS</small>	1	-	-	-	-	-	-	-	-	-	-	-
Cylindre ADRIATIC à bouton 40 x 30 mm nickelé 3 clés	00048430 <small>NS</small>	1	-	-	-	-	-	-	-	-	-	-	-
Cylindre ADRIATIC à bouton 40 x 35 mm nickelé 3 clés	00048435 <small>NS</small>	1	-	-	-	-	-	-	-	-	-	-	-
Cylindre ADRIATIC à bouton 40 x 40 mm nickelé 3 clés	00048440 <small>NS</small>	1	-	-	-	-	-	-	-	-	-	-	-
Cylindre ADRIATIC à bouton 40 x 45 mm nickelé 3 clés	00048445 <small>NS</small>	1	-	-	-	-	-	-	-	-	-	-	-
Cylindre ADRIATIC à bouton 40 x 50 mm nickelé 3 clés	00048450 <small>NS</small>	1	-	-	-	-	-	-	-	-	-	-	-
Cylindre ADRIATIC à bouton 40 x 55 mm nickelé 3 clés	00048455 <small>NS</small>	1	-	-	-	-	-	-	-	-	-	-	-
Cylindre ADRIATIC à bouton 40 x 60 mm nickelé 3 clés	00048460 <small>NS</small>	1	-	-	-	-	-	-	-	-	-	-	-
Cylindre ADRIATIC à bouton 40 x 70 mm nickelé 3 clés	00048470 <small>NS</small>	1	-	-	-	-	-	-	-	-	-	-	-

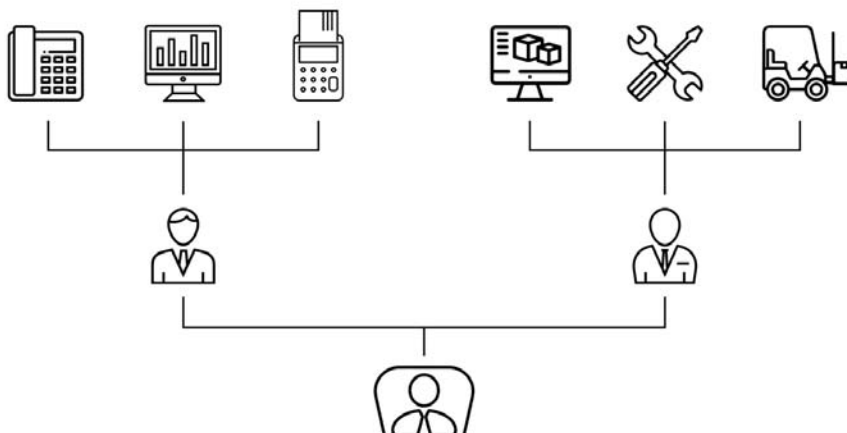

NS Non stocké/Non-stored/Producto no estocado - □ Sur stock Europe Zone 1 et Zone 2, nous consulter pour délai d'approvisionnement - E Epuement/Stock depletion/Agotamiento del stock

Cylindre de haute sûreté / TRAFIC 6

PROTECT



NIVEAU DE SÛRETÉ



GARANTIE



X 5



Clés longues pour utilisation avec rosace de sûreté



Protection Arrachement



Protection Perçage



Protection Crochetage

Description/Description/Descripción

Profil européen laiton. Mécanisme à 6 goupilles contre le crochetage. Protection contre le perçage par 1ère goupille en acier trempé. Panneton anti arrachement. 5 clés plates réversibles longues acier nickelé avec carte personnelle.

European brass profile. 6 pin mechanism. Protection against drilling by hardened steel pin. Driver cam made of powdered metal. . 5 reversible steel nickel plated keys with a personal security card.

Perfil europeo de latón. Mecanismo de 6 pistones de alpaca. Protección contra el taladrado por medio de un pasador de acero templado. Pivote de acero sinterizado antiarrancamiento. 5 llaves planas reversibles de acero niquelado con título de propiedad.

Finition/Finish/Acabado

Nickel satin, laiton
Nickel plated, brass
Niquelado, latón

Versión/Option/Versión

Demi-cylindre - Cylindre 2 entrées - Cylindre 1 entrée à bouton. Panneton réduit - Possibilité de s'entrouvrant (livré avec 4 clés).

1/2 cylinder with key way. Cylinder with 2 key ways. Cylinder with key way and inside knob. Reduced cam. Keyed alike (4 keys) on request.

Semicilindro. Cilindro de 2 entradas. Cilindro 1 entrada de botón. Leva corta - Disponible en versión misma llave (suministrado con 4 llaves).

Designation	Boite	Colis.	Prix	Sachet	Colis.	Prix	Brochable					Colis.	Prix
							France	Euro 1	Euro 2	Euro 3	Euro 4		
Demi-cylindre TRAFIC 6 30 x 10 mm nickelé 5 clés	00017739	1	-	00917739	20	-	00217739	00293164 NS	00292164 NS	00294164	-	5	-
Demi-cylindre TRAFIC 6 60 x 10 mm nickelé 5 clés	00017738	1	-	-	-	-	-	-	-	-	-	-	-
Cylindre TRAFIC 6 30 x 30 mm nickelé 5 clés	00017759	1	-	00917759	20	-	00217759	00293165 NS	00292165 NS	00294165	-	5	-
Cylindre TRAFIC 6 30 x 30 mm nickelé 5 clés nickelé panneton réduit 3 clés	00017761	1	-	-	-	-	00217761	-	-	00294271	-	5	-
Cylindre TRAFIC 6 35 x 35 mm nickelé 5 clés	00017779	1	-	-	-	-	00217779	00293170 NS	00292170 NS	00294170	-	5	-
Cylindre TRAFIC 6 40 x 40 mm nickelé 5 clés	00017789	1	-	-	-	-	00217789	00293172 NS	00292172 NS	00294172	-	5	-
Cylindre TRAFIC 6 30 x 40 mm nickelé 5 clés	00017769	1	-	00917769	20	-	00217769	00293168 NS	00292168 NS	00294168	-	5	-
Cylindre TRAFIC 6 30 x 50 mm nickelé 5 clés	00017780	1	-	-	-	-	00217780	00293447 NS	00292447 NS	00294447	-	5	-
Cylindre TRAFIC 6 30 x 60 mm nickelé 5 clés	00017790	1	-	00917790	20	-	00217790	00293169 NS	00292169 NS	00294169	-	5	-
Cylindre TRAFIC 6 30 x 65 mm nickelé 5 clés	00017796	1	-	00917796	20	-	00217796	-	-	-	-	5	-
Cylindre TRAFIC 6 30 x 70 mm nickelé 5 clés	00017792	1	-	-	-	-	00217792	-	-	-	-	5	-
Cylindre TRAFIC 6 35 x 45 mm nickelé 5 clés	00017781	1	-	-	-	-	00217781	00293171 NS	00292171 NS	00294171	-	5	-

NS Non stocké/Non-stored/Producto no estocado - ☐ Sur stock Europe Zone 1 et Zone 2, nous consulter pour délai d'approvisionnement - ☒ Epuisement/Stock depletion/Agotamiento del stock

Designation	Boite	Colis.	Prix	Sachet	Colis.	Prix	Brochable					Colis.	Prix
							France	Euro 1	Euro 2	Euro 3	Euro 4		
Cylindre TRAFIC 6 35 x 50 mm nickelé 5 clés	-	-	-	-	-	-	00217782	-	-	-	-	5	-
Cylindre TRAFIC 6 40 x 45 mm nickelé 5 clés	00017788	1	-	00917788	20	-	00217788	00293650 NSI	-	-	-	5	-
Cylindre TRAFIC 6 40 x 50 mm nickelé 5 clés	00017791	1	-	-	-	-	00217791	-	00292449	-	-	5	-
Cylindre TRAFIC 6 à bouton 30 x 30 mm nickelé 5 clés	00017757	1	-	00917757	20	-	00217757	00293166 NSI	00292166 NSI	00294166	-	5	-
Cylindre TRAFIC 6 à bouton 30 x 40 mm nickelé 5 clés	00017756	1	-	-	-	-	00217756	00293653 NSI	-	-	-	5	-
Lot de 2 cylindres TRAFIC 6 30 x 30 mm nickelé 10 clés identiques	-	-	-	-	-	-	00227759	00293167 NSI	00292167 NSI	00294167	-	5	-
Cylindre TRAFIC 6 30 x 10 mm laiton 5 clés	00017660	1	-	-	-	-	00217660	00293619 NSI	00292619 NSI	00294619	-	5	-
Cylindre TRAFIC 6 30 x 30 mm laiton 5 clés	00017661	1	-	-	-	-	00217661	00293620 NSI	00292620 NSI	00294620	-	5	-
Cylindre TRAFIC 6 35 x 35 mm laiton 5 clés	00017665	1	-	-	-	-	00217665	00293322 NSI	00292622 NSI	00294622	-	5	-
Cylindre TRAFIC 6 40 x 40 mm laiton 5 clés	00017666	1	-	-	-	-	00217666	00293624 NSI	00292624 NSI	00294624	-	5	-
Cylindre TRAFIC 6 30 x 40 mm laiton 5 clés	00017664	1	-	-	-	-	00217664	00293621 NSI	00292621 NSI	00294621	-	5	-
Cylindre TRAFIC 6 30 x 50 mm laiton 5 clés	00017667	1	-	-	-	-	00217667	00293623 NSI	00292623 NSI	00294623	-	5	-
Cylindre TRAFIC 6 à bouton 30 x 30 mm laiton 5 clés	00017663	1	-	-	-	-	00217663	00293625 NSI	00292625 NSI	00294625	-	5	-
Lot de 2 cylindres TRAFIC 6 30 x 30 mm laiton 10 clés identiques	00017662	1	-	-	-	-	00217662	-	-	00294656	-	5	-
Cylindre TRAFIC 6 30 x 30 mm nickelé 5 clés - fonction urgence	00017721	1	-	-	-	-	00217721	-	-	-	-	5	-
Cylindre TRAFIC 6 35 x 35 mm nickelé 5 clés - fonction urgence	00017722	1	-	-	-	-	00217722	-	-	-	-	5	-
Cylindre TRAFIC 6 40 x 40 mm nickelé 5 clés - fonction urgence	00017723	1	-	-	-	-	00217723	-	-	-	-	5	-
Cylindre TRAFIC 6 30 x 40 mm nickelé 5 clés - fonction urgence	00017724	1	-	-	-	-	00217724	-	-	-	-	5	-
Cylindre TRAFIC 6 30 x 50 mm nickelé 5 clés - fonction urgence	00017725	1	-	-	-	-	-	-	-	-	-	-	-
Cylindre TRAFIC 6 30 x 60 mm nickelé 5 clés - fonction urgence	00017726	1	-	-	-	-	-	-	-	-	-	-	-
Cylindre TRAFIC 6 35 x 45 mm nickelé 5 clés - fonction urgence	00017727	1	-	-	-	-	00217727	-	-	-	-	5	-
Cylindre TRAFIC 6 40 x 45 mm nickelé 5 clés - fonction urgence	00017729	1	-	-	-	-	-	-	-	-	-	-	-
Cylindre TRAFIC 6 40 x 50 mm nickelé 5 clés - fonction urgence	00017728	1	-	-	-	-	-	-	-	-	-	-	-
Lot de 2 cylindres TRAFIC 6 30 x 30 mm nickelé 10 clés identiques - fonction urgence	-	-	-	-	-	-	00217729	-	-	-	-	5	-



NS Non stocké/Non-stored/Productos no estocado - S Sur stock Europe Zone 1 et Zone 2, nous consulter pour délai d'approvisionnement - E Epuement/Stock depletion/Agotamiento del stock

Cylindre de haute sûreté / TRAFIC 12

PROTECT



NIVEAU DE SÉCURITÉ



GARANTIE



Clés longues pour utilisation avec rosace de sécurité



Protection Arrachement



Protection Perçage



Protection Crochetage



Protection Casse



Protection Snap

Cylindre conforme à la norme

EN 1303:2015

Classification

16000C5C

Description/Description/Descripción

Profil européen laiton. Mécanisme à 8 goupilles contre le crochetage. Protection contre le perçage par aiguille et 1ère goupille en acier trempé. Protection contre la casse par poutre. Protection contre l'effraction de la partie saillante du cylindre (anti-snap). Panneton anti arrachement. 5 clés plates réversibles longues laiton nickelé avec carte de propriété.

European brass profile. 8 pins mechanism anti-picking. Protection against drilling by hardened steel pins. Steel girder protecting against damage. Protection against the intrusion of the projecting portion of the cylinder (anti-snap). Driver cam made of powdered metal. 5 long reversible brass nickel plated keys with a personal security card for key copie.

Perfil europeo de latón. Mecanismo de 8 pistones inviolables. Protección contra el taladrado por medio de una aguja y un pasador de acero templado. Protección contra la rotura con una barra de refuerzo de acero. Protección contra la manipulación de la parte saliente de cilindro. Pivote de acero sinterizado antiarrancamiento. 5 llaves planas largas reversibles de latón níquelado con título de propiedad.

Finition/Finish/Acabado

Nickel satin, laiton
Nickel plated, brass
Níquelado, latón

Versión/Option/Versión

Demi-cylindre - Cylindre 2 entrées - Cylindre 1 entrée à bouton. Panneton réduit - Possibilité de s'entrouvrant.
1/2 cylinder with key way. Cylinder with 2 key ways. Cylinder with key way and inside knob. Reduced cam. Keyed alike on request.

Semicilindro. Cilindro de 2 entradas. Cilindro 1 entrada de botón. Leva corta - Disponible en versión misma llave.



NIVEAU DE SÉCURITÉ



Designation	Boite	Colis.	Prix	Sachet	Colis.	Prix	Brochable					Colis.	Prix
							France	Euro 1	Euro 2	Euro 3	Euro 4		
Demi-cylindre TRAFIC 12 30 x 10 mm nickelé 5 clés	00019739	1	-	00919739	20	-	00219739	00293580 NS	00292580 NS	00294580	-	5	-
Demi-cylindre TRAFIC 12 60 x 10 mm nickelé 5 clés	00019740	1	-	-	-	-	-	-	-	-	-	-	-
Cylindre TRAFIC 12 30 x 30 mm nickelé 5 clés	00019759	1	-	00919759	20	-	00219759	00293582 NS	00292582 NS	00294582	-	5	-
Cylindre TRAFIC 12 35 x 35 mm nickelé 5 clés	00019779	1	-	-	-	-	00219779	00293588 NS	00292588 NS	00294588	-	5	-
Cylindre TRAFIC 12 40 x 40 mm nickelé 5 clés	00019789	1	-	-	-	-	00219789	00293587 NS	00292587 NS	00294587	-	5	-
Cylindre TRAFIC 12 30 x 40 mm nickelé 5 clés	00019769	1	-	00919769	20	-	00219769	00293584 NS	00292584 NS	00294584	-	5	-
Cylindre TRAFIC 12 30 x 50 mm nickelé 5 clés	00019780	1	-	-	-	-	-	-	-	00294591	-	5	-
Cylindre TRAFIC 12 30 x 60 mm nickelé 5 clés	00019790	1	-	-	-	-	00219790	00293585 NS	00292585 NS	00294585	-	5	-
Cylindre TRAFIC 12 30 x 65 mm nickelé 5 clés	-	-	-	00919799	20	-	00219799	00293586 NS	00292586 NS	00294586	-	5	-
Cylindre TRAFIC 12 35 x 45 mm nickelé 5 clés	00019781	1	-	-	-	-	-	-	-	-	-	-	-
Cylindre TRAFIC 12 à bouton 30 x 30 mm nickelé 5 clés	00019757	1	-	00919757	20	-	00219757	00293583 NS	00292583 NS	00294583	-	5	-
Cylindre TRAFIC 12 à bouton 30 x 40 mm nickelé 5 clés	00019756	1	-	-	-	-	-	-	-	-	-	-	-
Cylindre TRAFIC 12 à bouton 40 x 30 mm nickelé 5 clés	00019765	1	-	-	-	-	-	-	-	-	-	-	-
Lot de 2 cylindres TRAFIC 12 30 x 30 mm nickelé 10 clés identiques	-	-	-	-	-	-	00229759	00293581 NS	00291581 NS	00294581	-	5	-
Cylindre TRAFIC 12 30 x 10 mm laiton 5 clés	00019771	1	-	-	-	-	-	-	-	00294510	-	5	-
Cylindre TRAFIC 12 30 x 30 mm laiton 5 clés	00019772	1	-	-	-	-	-	-	-	00294512	-	5	-
Cylindre TRAFIC 12 35 x 35 mm laiton 5 clés	00019773	1	-	-	-	-	-	-	-	00294513	-	5	-
Cylindre TRAFIC 12 40 x 40 mm laiton 5 clés	00019774	1	-	-	-	-	-	-	-	00294515	-	5	-
Cylindre TRAFIC 12 30 x 40 mm laiton 5 clés	00019775	1	-	-	-	-	-	-	-	00294516	-	5	-



Cylindre de haute sûreté / TRANSIT 1

PROTECT



NIVEAU DE SÉCURITÉ



GARANTIE



X 5



Protection Arrachement



Protection Perçage



Protection Crochetage



Protection Snap

Description/Description/Descripción

Profil européen laiton. Mécanisme à 6 goupilles protection contre le crochetage. Protection contre le perçage par 1ère goupille + poussoir en acier trempé. Protection contre l'effraction de la partie saillante du cylindre (anti-snap). Panneton anti arrachement. 5 clés plates réversibles longues acier nickelé avec carte personnelle.

European brass profile. 6 nickel silver pin mechanism. Protection against drilling by hardened steel pins. Protection against the intrusion of the projecting portion of the cylinder (anti-snap). Driver cam made of powdered metal. 5 reversible steel nickel plated keys with a personal security card for key copies.

Perfil europeo de latón. Mecanismo de 6 pistones de alpaca. Protección contra el taladrado por medio de un pasador de acero templado. Protección contra la manipulación de la parte saliente de cilindro

Pivote de acero sinterizado antiarrancamiento. 5 llaves planas reversibles de acero niquelado con título de propiedad que permite su reproducción en fábrica.

Finition/Finish/Acabado

Nickelé, laiton
Nickel plated, brass
Niquelado, latón

Version/Option/Versión

Demi-cylindre. Cylindre 2 entrées. Cylindre 1 entrée à bouton. Panneton orientable pour la dimension 30x10 (autres dimensions sur demande).

1/2 cylinder with key way. Cylinder with 2 key ways. Cylinder with key way and inside knob. Indexable cam on half cylinder (other dimensions on request).

Semicilindro, cilindro de 2 entradas. Cilindro 1 entrada de botón. Paletón indexable sobre semi-cilindro (otras dimensiones sobre demanda).

Designation	Boite	Colis.	Prix	Sachet	Colis.	Prix	Brochable					Colis.	Prix
							France	Euro 1	Euro 2	Euro 3	Euro 4		
Demi-cylindre TRANSIT 1 30 x10 mm nickelé panneton orientable 5 clés	00021739	1	-	-	-	-	00221739	00293974	-	00294974	-	5	-
Cylindre TRANSIT 1 30 x 30 mm nickelé 5 clés	00021759	1	-	-	-	-	00221759	00293771	00292771	00294771	-	5	-
Cylindre TRANSIT 1 35 x 35 mm nickelé 5 clés	00021770	1	-	-	-	-	00221770	00293775	-	00294775	-	5	-
Cylindre TRANSIT 1 40 x 40 mm nickelé 5 clés	00021780	1	-	-	-	-	00221780	00293779	00292779	00294779	-	5	-
Cylindre TRANSIT 1 28 x 33 mm nickelé 5 clés	-	-	-	-	-	-	-	-	-	00294870	-	5	-
Cylindre TRANSIT 1 30 x 35 mm nickelé 5 clés	-	-	-	-	-	-	-	-	-	00294871	-	5	-
Cylindre TRANSIT 1 30 x 40 mm nickelé 5 clés	00021769	1	-	-	-	-	00221769	00293782	00292782	00294782	-	5	-
Cylindre TRANSIT 1 30 x 45 mm nickelé 5 clés	-	-	-	-	-	-	-	-	-	00294872	-	5	-
Cylindre TRANSIT 1 30 x 50 mm nickelé 5 clés	00021779	1	-	-	-	-	00221779	00293788	-	00294788	-	5	-

⚠ Non stocké/Non-stored/Producto no estocado - 📦 Sur stock Europe Zone 1 et Zone 2, nous consulter pour délai d'approvisionnement - 📦 Epuisement/Stock depletion/Agotamiento del stock

Cylindre de haute sûreté / TRANSIT 1

PROTECT



NIVEAU DE SÉCURITÉ



Designation	Boite	Colis.	Prix	Sachet	Colis.	Prix	Brochable					Colis.	Prix
							France	Euro 1	Euro 2	Euro 3	Euro 4		
Cylindre TRANSIT 1 30 x 60 mm nickelé 5 clés	00021799	1	-	-	-	-	00221799	00293792	-	00294792	-	5	-
Cylindre TRANSIT 1 35 x 45 mm nickelé 5 clés	00021790	1	-	-	-	-	00221790	00293784	-	00294784	-	5	-
Cylindre TRANSIT 1 40 x 45 mm nickelé 5 clés	-	-	-	-	-	-	00221751	-	-	-	-	5	-
Cylindre TRANSIT 1 40 x 50 mm nickelé 5 clés	-	-	-	-	-	-	00221752	-	00292798	-	-	5	-
Cylindre TRANSIT 1 40 x 60 mm nickelé 5 clés	-	-	-	-	-	-	00221753	-	00292971	-	-	5	-
Cylindre TRANSIT 1 45 x 50 mm nickelé 5 clés	-	-	-	-	-	-	00221754	-	00292972	-	-	5	-
Cylindre TRANSIT 1 à bouton 30BT x 30 mm nickelé 5 clés	00021757	1	-	-	-	-	00221757	00293773	-	00294773	-	5	-
Cylindre TRANSIT 1 à bouton 35BT x 35 mm nickelé 5 clés	-	-	-	-	-	-	-	00293777	-	00294777	-	5	-
Cylindre TRANSIT 1 à bouton 40BT x 40 mm nickelé 5 clés	-	-	-	-	-	-	00221755	00293781	-	00294781	-	5	-
Cylindre TRANSIT 1 à bouton 28BT x 33 mm nickelé 5 clés	-	-	-	-	-	-	-	-	-	00294873	-	5	-
Cylindre TRANSIT 1 à bouton 30BT x 45 mm nickelé 5 clés	-	-	-	-	-	-	-	-	-	00294875	-	5	-
Cylindre TRANSIT 1 à bouton 40BT X 30 mm nickelé 5 clés	-	-	-	-	-	-	00221758	-	00292973	-	-	5	-
Cylindre TRANSIT 1 à bouton 40BT x 50 mm nickelé 5 clés	-	-	-	-	-	-	-	-	-	00294877	-	5	-
Cylindre TRANSIT 1 à bouton 40BT x 60 mm nickelé 5 clés	-	-	-	-	-	-	-	-	-	00294878	-	5	-
Cylindre TRANSIT 1 à bouton 45BT x 35 mm nickelé 5 clés	-	-	-	-	-	-	-	00293786	-	00294876	-	5	-
Cylindre TRANSIT 1 à bouton 50BT X 30 mm nickelé 5 clés	-	-	-	-	-	-	-	00293790	-	-	-	5	-
Cylindre TRANSIT 1 à bouton 60BT X 30mm nickelé 5 clés	-	-	-	-	-	-	-	00293794	-	-	-	5	-
Lot de 2 Cylindres TRANSIT 1 30 x 30 mm nickelé 10 clés identiques	-	-	-	-	-	-	00221762	-	-	-	-	5	-
Cylindre TRANSIT 1 30 x 30 mm laiton 5 clés	-	-	-	-	-	-	-	00293770	-	00294770	-	5	-
Cylindre TRANSIT 1 35 x 35 mm laiton 5 clés	-	-	-	-	-	-	-	00293774	-	00294774	-	5	-
Cylindre TRANSIT 1 40 x 40 mm laiton 5 clés	-	-	-	-	-	-	-	00293778	-	00294778	-	5	-
Cylindre TRANSIT 1 30 x 40 mm laiton 5 clés	-	-	-	-	-	-	-	00293795	-	00294795	-	5	-
Cylindre TRANSIT 1 30 x 50 mm laiton 5 clés	-	-	-	-	-	-	-	00293787	-	00294787	-	5	-
Cylindre TRANSIT 1 30 x 60 mm laiton 5 clés	-	-	-	-	-	-	-	00293791	-	00294791	-	5	-
Cylindre TRANSIT 1 35 x 45 mm laiton 5 clés	-	-	-	-	-	-	-	00293783	-	00294783	-	5	-

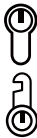

☐ Non stocké/Non-stored/Productos no estocados - ☑ Sur stock Europe Zone 1 et Zone 2, nous consulter pour délai d'approvisionnement - ☒ Epuisement/Stock depletion/Agotamiento del stock

Cylindre de haute sûreté / TRANSIT 1

PROTECT



NIVEAU DE SÉCURITÉ



Designation	Boite	Colis.	Prix	Sachet	Colis.	Prix	Brochable					Colis.	Prix
							France	Euro 1	Euro 2	Euro 3	Euro 4		
Cylindre TRANSIT 1 à bouton 30BT x 30 mm laiton 5 clés	-	-	-	-	-	-	-	00293772	-	00294772	-	5	-
Cylindre TRANSIT 1 à bouton 35BT x 35 mm laiton 5 clés	-	-	-	-	-	-	-	00293776	-	00294776	-	5	-
Cylindre TRANSIT 1 à bouton 40BT x 40 mm laiton 5 clés	-	-	-	-	-	-	-	00293780	-	00294780	-	5	-
Cylindre TRANSIT 1 à bouton 45BT x 35 mm laiton 5 clés	-	-	-	-	-	-	-	00293785	-	-	-	5	-
Cylindre TRANSIT 1 à bouton 50BT X 30 mm laiton 5 clés	-	-	-	-	-	-	-	00293789	-	-	-	5	-
Cylindre TRANSIT 1 à bouton 60BT X 30 mm laiton 5 clés	-	-	-	-	-	-	-	00293793	-	-	-	5	-
Demi-cylindre TRANSIT 1 30 x 10 mm nickelé 5 clés - Fonction urgence	00021910	1	-	-	-	-	00221910	-	-	-	-	10	-
Demi-cylindre TRANSIT 1 40 x 10 mm nickelé 5 clés - Fonction urgence	00021911	1	-	-	-	-	-	-	-	-	-	-	-
Cylindre TRANSIT 1 30 x 30 mm nickelé 5 clés - Fonction urgence	00021912	1	-	-	-	-	00221912	-	-	-	-	10	-
Cylindre TRANSIT 1 35 x 35 mm nickelé 5 clés - Fonction urgence	00021920	1	-	-	-	-	00221920	-	-	-	-	10	-
Cylindre TRANSIT 1 40 x 40 mm nickelé 5 clés - Fonction urgence	00021923	1	-	-	-	-	00221923	-	-	-	-	10	-
Cylindre TRANSIT 1 45 x 45 mm nickelé 5 clés - Fonction urgence	00021929	1	-	-	-	-	-	-	-	-	-	-	-
Cylindre TRANSIT 1 50 x 50 mm nickelé 5 clés - Fonction urgence	00021932	1	-	-	-	-	-	-	-	-	-	-	-
Cylindre TRANSIT 1 30 x 35 mm nickelé 5 clés - Fonction urgence	00021913	1	-	-	-	-	-	-	-	-	-	-	-
Cylindre TRANSIT 1 30 x 40 mm nickelé 5 clés - Fonction urgence	00021914	1	-	-	-	-	00221914	-	-	-	-	10	-
Cylindre TRANSIT 1 30 x 50 mm nickelé 5 clés - Fonction urgence	00021915	1	-	-	-	-	-	-	-	-	-	-	-
Cylindre TRANSIT 1 30 x 60 mm nickelé 5 clés - Fonction urgence	00021916	1	-	-	-	-	-	-	-	-	-	-	-
Cylindre TRANSIT 1 30 x 65 mm nickelé 5 clés - Fonction urgence	00021917	1	-	-	-	-	-	-	-	-	-	-	-
Cylindre TRANSIT 1 30 x 70 mm nickelé 5 clés - Fonction urgence	00021918	1	-	-	-	-	-	-	-	-	-	-	-
Cylindre TRANSIT 1 30 x 80 mm nickelé 5 clés - Fonction urgence	00021919	1	-	-	-	-	-	-	-	-	-	-	-

Ⓝ Non stocké/Non-stored/Producto no estocado - ☑ Sur stock Europe Zone 1 et Zone 2, nous consulter pour délai d'approvisionnement - ☒ Epuisement/Stock depletion/Agotamiento del stock

Cylindre de haute sûreté / TRANSIT 1

PROTECT



NIVEAU DE SÉCURITÉ



Designation	Boîte	Colis.	Prix	Sachet	Colis.	Prix	Brochable					Colis.	Prix
							France	Euro 1	Euro 2	Euro 3	Euro 4		
Cylindre TRANSIT 1 35 x 45 mm nickelé 5 clés - Fonction urgence	00021921	1	-	-	-	-	00221921	-	-	-	-	10	-
Cylindre TRANSIT 1 35 x 50 mm nickelé 5 clés - Fonction urgence	00021922	1	-	-	-	-	-	-	-	-	-	-	-
Cylindre TRANSIT 1 40 x 45 mm nickelé 5 clés - Fonction urgence	00021924	1	-	-	-	-	-	-	-	-	-	-	-
Cylindre TRANSIT 1 40 x 50 mm nickelé 5 clés - Fonction urgence	00021925	1	-	-	-	-	-	-	-	-	-	-	-
Cylindre TRANSIT 1 40 x 55 mm nickelé 5 clés - Fonction urgence	00021926	1	-	-	-	-	-	-	-	-	-	-	-
Cylindre TRANSIT 1 40 x 60 mm nickelé 5 clés - Fonction urgence	00021927	1	-	-	-	-	-	-	-	-	-	-	-
Cylindre TRANSIT 1 40 x 70 mm nickelé 5 clés - Fonction urgence	00021928	1	-	-	-	-	-	-	-	-	-	-	-
Cylindre TRANSIT 1 45 x 50 mm nickelé 5 clés - Fonction urgence	00021930	1	-	-	-	-	-	-	-	-	-	-	-
Cylindre TRANSIT 1 45 x 55 mm nickelé 5 clés - Fonction urgence	00021931	1	-	-	-	-	-	-	-	-	-	-	-
Cylindre TRANSIT 1 50 x 60 mm nickelé 5 clés - Fonction urgence	00021933	1	-	-	-	-	-	-	-	-	-	-	-
Cylindre TRANSIT 1 à bouton 30BT x 30 mm nickelé 5 clés - Fonction urgence	00021934	1	-	-	-	-	-	-	-	-	-	-	-
Cylindre TRANSIT 1 à bouton 35BT x 35 mm nickelé 5 clés - Fonction urgence	00021936	1	-	-	-	-	-	-	-	-	-	-	-
Cylindre TRANSIT 1 à bouton 30BT x 40 mm nickelé 5 clés - Fonction urgence	00021935	1	-	-	-	-	-	-	-	-	-	-	-
Cylindre TRANSIT 1 à bouton 40BT x 30 mm nickelé 5 clés - Fonction urgence	00021937	1	-	-	-	-	-	-	-	-	-	-	-
Cylindre TRANSIT 1 à bouton 40BT x 40 mm nickelé 5 clés - Fonction urgence	00021938	1	-	-	-	-	-	-	-	-	-	-	-
Cylindre TRANSIT 1 35 x 30 mm nickelé 5 clés - SNAP côté 30	00021625	1	-	-	-	-	-	-	-	-	-	-	-
Cylindre TRANSIT 1 40 x 30 mm nickelé 5 clés - SNAP côté 30	00021626	1	-	-	-	-	-	-	-	-	-	-	-
Cylindre TRANSIT 1 45 x 30 mm nickelé 5 clés - SNAP côté 30	00021627	1	-	-	-	-	-	-	-	-	-	-	-

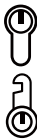

Non stocké/Non-stored/Productos no estocados - Sur stock Europe Zone 1 et Zone 2, nous consulter pour délai d'approvisionnement - Epuement/Stock depletion/Agotamiento del stock

Cylindre de haute sûreté / TRANSIT 1

PROTECT



NIVEAU DE SÉCURITÉ



GARANTIE



X 4



Les + : Bouton recoupable et clé de chantier :
Modification de la combinaison après les travaux
avec la clé «Propriétaire».



Protection
Arrachement



Protection
Perçage



Protection
Crochetage



Protection
Snap

Description/Description/Descripción

Profil européen laiton. Mécanisme à 6 goupilles.
Protection contre le crochetage. Protection contre le perçage par 1ère goupille + poussoir en acier trempé.
Protection contre l'effraction de la partie saillante du cylindre (anti-snap). Panneton anti arrachement. 1 clé «Chantier» + 4 clés plates réversibles laiton nickelé avec carte personnelle.

European brass profile. 6 pins mechanism. Antipicking system Protection against drilling by hardened steel pins. Protection against the intrusion of the projecting portion of the cylinder (anti-snap). Driver cam made of powdered metal. 1 key Construction site + 4 reversible brass nickel plated keys with personal security card for key copies.

Perfil europeo de latón. Mecanismo de 6 pistones.
Protección contra el forzamiento. Protección contra el taladrado mediante un pasador y un empujador de acero templado. Protección contra la manipulación de la parte saliente de cilindro. Pivote de acero sinterizado antiarrancamiento. 1 llave «Sitio» + 4 llaves planas reversibles de latón niquelado con título de propiedad.

Finition/Finish/Acabado

Nickel velours
Dull nickel plated
Níquel terciopelo

Cylindre de haute sûreté / TRANSIT 1

PROTECT



NIVEAU DE SÉCURITÉ

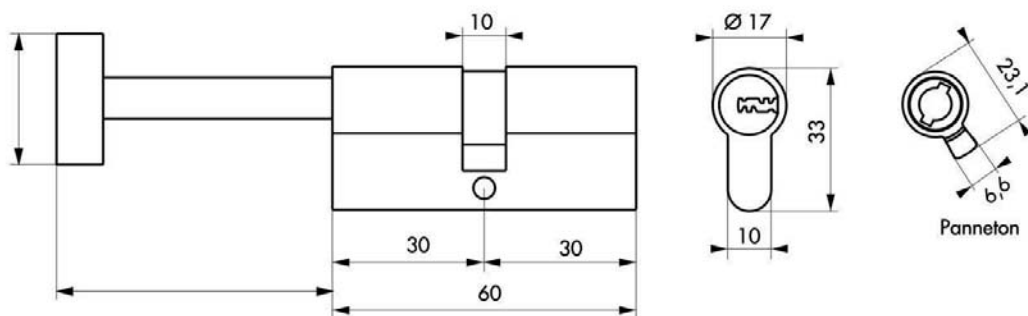

Designation	Boite	Colis.	Prix	Sachet	Colis.	Prix	Brochable					Colis.	Prix
							France	Euro 1	Euro 2	Euro 3	Euro 4		
Cylindre TRANSIT 1 30BT x 30 mm nickelé 4 clés + 1 clé chantier	00094879	1	-	-	-	-	-	-	-	00294879	-	5	-
Cylindre TRANSIT 1 30BT x 35 mm nickelé 4 clés + 1 clé chantier	00094883	1	-	-	-	-	-	-	-	00294883	-	5	-
Cylindre TRANSIT 1 30BT x 40 mm nickelé 4 clés + 1 clé chantier	00094884	1	-	-	-	-	-	-	-	00294884	-	5	-
Cylindre TRANSIT 1 30BT x 50 mm nickelé 4 clés + 1 clé chantier	00094885	1	-	-	-	-	-	-	-	00294885	-	5	-

Non stocké/Non-stored/Producto no estocado - Sur stock Europe Zone 1 et Zone 2, nous consulter pour délai d'approvisionnement - Epuement/Stock depletion/Agotamiento del stock

Cylindre de haute sûreté / TRANSIT 2

RESIST



NIVEAU DE SÉCURITÉ



GARANTIE



X 5



Protection Arrachement



Protection Perçage



Protection Crochetage



Protection Snap

Cylindre conforme à la norme

EN 1303:2015

Classification

1 6 0 0 0 B 5 1

Description/Description/Descripción

Profil européen laiton. Mécanisme à 8 goupilles contre le crochetage. Protection contre le perçage par aiguille + 1ère goupille + poussoir en acier trempé. Protection contre l'effraction de la partie saillante du cylindre (anti-snap). Panneton anti arrachement. 5 clés plates longues réversibles laiton nickelé avec carte de propriété. Fonction urgence : panneton débrayable, ouverture possible de l'extérieur même si une clé est restée à l'intérieur.

European brass profile. 8 nickel silver pin mechanism. Protection against drilling by hardened steel insert and pins. Protection against the destruction of the projecting portion of the cylinder (anti-snap). Drivercam made of powdered metal. 5 long reversible brass nickel plated keys with a personal security card for key copies. Emergency function : the cylinder can work even if a key is inserted on the inner side of the door.

Perfil europeo de latón. Mecanismo de 8 pistones de alpaca. Protección contra el taladrado por medio de una aguja y un pasador de acero templado. Protección contra la manipulación de la parte saliente de cilindro. Pivote de acero sinterizado antiarrancamiento. 5 llaves planas largas reversibles de latón niquelado con título de propiedad que permite su reproducción en fábrica. Función de emergencia : se puede introducir una llave en el cilindro y girar el pivote incluso si ya hay una llave introducida.

Finition/Finish/Acabado

Nickel velours

Dull nickel plated

Níquel terciopelo

Versión/Option/Versión

Demi-cylindre. Cylindre 2 entrées. Cylindre 1 entrée à bouton. Fonction urgence : Possibilité d'introduire une clé dans le cylindre et tourner le panneton même si une clé est engagée à l'intérieur (panneton débrayable). Cadenas, batteuse, barillet contacteur. Panneton orientable pour la dimension 30x10 (autres dimensions sur demande). Possibilité de montage avec bouton débrayable. Possibilité de montage sur organigramme avec 3 clés.

1/2 cylinder with key way. Cylinder with 2 key ways. Cylinder with key way and inside knob. Emergency function : The cylinder can work even if a key is inserted on the inner side of the door. Padlock, Cam lock, key controlled contactor. Indexable cam on half cylinder (other dimensions on request). Master key system delivered with 3 keys.

Semicilindro, cilindro de 2 entradas. Cilindro 1 entrada de botón. Se puede introducir una llave en el cilindro y girar el pivote incluso si ya hay una llave introducida (función de emergencia). Cerradura, contactor de mando. Paletón indexable sobre semi-cilindro (otras dimensiones sobre demanda). Sistema organigrama entregada con 3 llaves.

Designation	Boite	Colis.	Prix	Sachet	Colis.	Prix	Brochable					Colis.	Prix
							France	Euro 1	Euro 2	Euro 3	Euro 4		
Demi-cylindre TRANSIT 2 30 mm nickelé pour cadenas 720 CP 5clés	00018738 NS	1	-	-	-	-	-	-	-	-	-	-	-
Demi-cylindre TRANSIT 2 30 x10 mm nickelé panneton orientable 5 clés	00018739	1	-	-	-	-	00218739	-	-	-	-	5	-
Demi-cylindre TRANSIT 2 60 x 10 mm nickelé 5 clés	00018740	1	-	-	-	-	-	-	-	-	-	-	-
Cylindre TRANSIT 2 30 x 30 mm nickelé 5 clés	00018759	1	-	-	-	-	00218759	00293173 E	00292173 E	00294173	-	5	-
Cylindre TRANSIT 2 35 x 35 mm nickelé 5 clés	00018770	1	-	-	-	-	00218770	00293179 E	-	00294180	-	5	-

NS Non stocké/Non-stored/Producto no estocado - E Sur stock Europe Zone 1 et Zone 2, nous consulter pour délai d'approvisionnement - E Epuisement/Stock depletion/Agotamiento del stock

Cylindre de haute sûreté / TRANSIT 2

RESIST



NIVEAU DE SÉCURITÉ

Designation	Boîte	Colis.	Prix	Sachet	Colis.	Prix	Brochable					Colis.	Prix
							France	Euro 1	Euro 2	Euro 3	Euro 4		
Cylindre TRANSIT 2 40 x 40 mm nickelé 5 clés	00018780	1	-	-	-	-	00218780	00293200	00292200	00294179	-	5	-
Cylindre TRANSIT 2 45 x 45 mm nickelé 5 clés	-	-	-	-	-	-	00218772	-	-	-	-	5	-
Cylindre TRANSIT 2 30 x 40 mm nickelé 5 clés	00018769	1	-	-	-	-	00218769	00293178	00292195	00294178	-	5	-
Cylindre TRANSIT 2 30 x 50 mm nickelé 5 clés	00018779	1	-	-	-	-	00218779	-	-	-	-	5	-
Cylindre TRANSIT 2 30 x 60 mm nickelé 5 clés	00018799	1	-	-	-	-	00218799	00293995	00292205	-	-	5	-
Cylindre TRANSIT 2 30 x 70 mm nickelé 5 clés	00021100	1	-	-	-	-	-	-	-	-	-	-	-
Cylindre TRANSIT 2 35 x 45 mm nickelé 5 clés	00018790	1	-	-	-	-	00218790	00293201	00292201	-	-	5	-
Cylindre TRANSIT 2 40 x 45 mm nickelé 5 clés	-	-	-	-	-	-	00218781	-	-	-	-	5	-
Cylindre TRANSIT 2 40 x 50 mm nickelé 5 clés	00018977	1	-	-	-	-	00218977	-	00292202	-	-	5	-
Cylindre TRANSIT 2 40 x 55 mm nickelé 5 clés	-	-	-	-	-	-	00218774	-	-	-	-	5	-
Cylindre TRANSIT 2 40 x 60 mm nickelé 5 clés	-	-	-	-	-	-	00218791	-	-	-	-	5	-
Cylindre TRANSIT 2 45 x 50 mm nickelé 5 clés	-	-	-	-	-	-	00218792	-	-	-	-	5	-
Cylindre TRANSIT 2 45 x 55 mm nickelé 5 clés	-	-	-	-	-	-	00218773	-	-	-	-	5	-
Cylindre TRANSIT 2 à bouton 30BT x 30 mm nickelé 5 clés	00018757	1	-	-	-	-	00218757	00293210	-	-	-	5	-
Cylindre TRANSIT 2 à bouton 30BT x 40 mm nickelé 5 clés	00018758	1	-	-	-	-	00218758	00293211	-	-	-	5	-
Cylindre TRANSIT 2 à bouton 40BT x 30 mm nickelé 5 clés	-	-	-	-	-	-	00218775	-	-	-	-	5	-
Cylindre TRANSIT 2 à bouton 40BT x 40 mm nickelé 5 clés	-	-	-	-	-	-	00218778	-	-	-	-	5	-
Lot de 2 cylindres TRANSIT 2 30 x 30 mm nickelé 10 clés identiques	-	-	-	-	-	-	00228759	-	-	-	-	5	-
Lot de 2 cylindres TRANSIT 2 30 x 40 mm nickelé 10 clés identiques	-	-	-	-	-	-	00228769	-	-	-	-	5	-
Cylindre TRANSIT 2 30 x 30 mm laiton 5 clés	00018747	1	-	-	-	-	-	-	-	00294956	-	5	-
Cylindre TRANSIT 2 35 x 35 mm laiton 5 clés	00018748	1	-	-	-	-	-	-	-	00294957	-	5	-
Cylindre TRANSIT 2 40 x 40 mm laiton 5 clés	00018749	1	-	-	-	-	-	-	-	00294958	-	5	-
Cylindre TRANSIT 2 30 x 40 mm laiton 5 clés	00018752	1	-	-	-	-	-	-	-	00294959	-	5	-
Cylindre TRANSIT 2 35 x 30 mm nickelé 5 clés - SNAP côté 30	00019829	1	-	-	-	-	00219829	-	-	-	-	5	-
Cylindre TRANSIT 2 40 x 30 mm nickelé 5 clés - SNAP côté 30	00019830	1	-	-	-	-	00219830	-	-	-	-	5	-
Cylindre TRANSIT 2 45 x 30 mm nickelé 5 clés - SNAP côté 30	00019831	1	-	-	-	-	00219831	-	-	-	-	5	-

Non stocké/Non-stored/Productos no estocados - Sur stock Europe Zone 1 et Zone 2, nous consulter pour délai d'approvisionnement - Epuement/Stock depletion/Agotamiento del stock

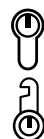

Cylindre de haute sûreté / TRANSIT 2 POUR ORGANIGRAMME RESIST



NIVEAU DE SÉCURITÉ



GARANTIE



X 3



Installation à combinaison centrale



Protection Arrachement



Protection Perçage



Protection Snap

Description/Description/Descripción

Profil européen laiton. Mécanisme à 7 à 16 goupilles. Protection contre l'effraction de la partie saillante du cylindre (anti-snap). Panneton anti arrachement. 3 clésplates réversibles laiton nickelé avec carte de propriété. Option : Protection contre le perçage par aiguille + 1ère goupille + poussoir en acier trempé. *European brass profile. 7 to 16 nickel silver pin mechanism. Protection against the destruction of the projecting portion of the cylinder (anti-snap). Drivercam made of powdered metal. 3 reversible brass nickel plated keys with a personal security card for key copies. Option : Protection against drilling by hardened steel insert and pins.*

Perfil europeo de latón. Mecanismo de 7 a 16 pistones de alpaca. Protección contra la manipulación de la parte saliente de cilindro. Pivote de acero sinterizado antiarrancamiento. 3 llaves planas reversibles de latón niquelado con título de propiedad que permite su reproducción en fábrica. Opción : Protección contra el taladrado por medio de una aguja y un pasador de acero templado.

Finition/Finish/Acabado

Nickel velours

Dull nickel plated

Níquel terciopelo

Version/Option/Versión

Demi-cylindre. Cylindre 2 entrées. Cylindre 1 entrée à bouton. Fonction urgence : Possibilité d'introduire une clé dans le cylindre et tourner le panneton même si une clé est engagée à l'intérieur (panneton débrayable). Cadenas, batteuse, barillet contacteur. Panneton orientable pour la dimension 30x10 (autres dimensions sur demande). Possibilité de montage avec bouton débrayable.

1/2 cylinder with key way. Cylinder with 2 key ways. Cylinder with key way and inside knob. Emergency function : The cylinder can work even if a key is inserted on the inner side of the door. Padlock, Cam lock, key controlled contactor. Indexable cam on half cylinder (other dimensions on request).

Semicilindro, cilindro de 2 entradas. Cilindro 1 entrada de botón. Se puede introducir una llave en el cilindro y girar el pivote incluso si ya hay una llave introducida (función de emergencia). Cerradura, contactor de mando. Paletón indexable sobre semi-cilindro (otras dimensiones sobre demanda).

Cylindre de haute sûreté / TRANSIT 2 POUR ORGANIGRAMME RESIST



NIVEAU DE SÉCURITÉ

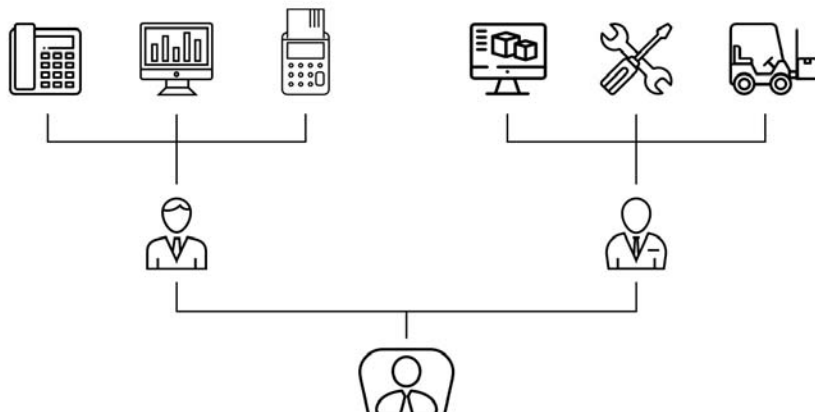

Designation	Boîte	Colis.	Prix	Sachet	Colis.	Prix	Brochable					Colis.	Prix
							France	Euro 1	Euro 2	Euro 3	Euro 4		
Demi-cylindre TRANSIT 2 30 x10 mm nickelé panneton orientable 3 clés	00018801 <small>NS</small>	1	-	-	-	-	-	-	-	-	-	-	-
Cylindre TRANSIT 2 35 x 10 mm nickelé 3 clés	00018802 <small>NS</small>	1	-	-	-	-	-	-	-	-	-	-	-
Cylindre TRANSIT 2 40 x 10 mm nickelé 3 clés	00018803 <small>NS</small>	1	-	-	-	-	-	-	-	-	-	-	-
Cylindre TRANSIT 2 45 x 10 mm nickelé 3 clés	00018804 <small>NS</small>	1	-	-	-	-	-	-	-	-	-	-	-
Cylindre TRANSIT 2 50 x 10 mm nickelé 3 clés	00018805 <small>NS</small>	1	-	-	-	-	-	-	-	-	-	-	-
Cylindre TRANSIT 2 55 x 10 mm nickelé 3 clés	00018806 <small>NS</small>	1	-	-	-	-	-	-	-	-	-	-	-
Cylindre TRANSIT 2 60 x 10 mm nickelé 3 clés	00018807 <small>NS</small>	1	-	-	-	-	-	-	-	-	-	-	-
Cylindre TRANSIT 2 70 x 10 mm nickelé 3 clés	00018808 <small>NS</small>	1	-	-	-	-	-	-	-	-	-	-	-
Cylindre TRANSIT 2 80 x 10 mm nickelé 3 clés	00018809 <small>NS</small>	1	-	-	-	-	-	-	-	-	-	-	-
Cylindre TRANSIT 2 30 x 30 mm nickelé 3 clés	00018810 <small>NS</small>	1	-	-	-	-	-	-	-	-	-	-	-
Cylindre TRANSIT 2 30 x 35 mm nickelé 3 clés	00018811 <small>NS</small>	1	-	-	-	-	-	-	-	-	-	-	-
Cylindre TRANSIT 2 30 x 40 mm nickelé 3 clés	00018812 <small>NS</small>	1	-	-	-	-	-	-	-	-	-	-	-
Cylindre TRANSIT 2 30 x 45 mm nickelé 3 clés	00018813 <small>NS</small>	1	-	-	-	-	-	-	-	-	-	-	-
Cylindre TRANSIT 2 30 x 50 mm nickelé 3 clés	00018814 <small>NS</small>	1	-	-	-	-	-	-	-	-	-	-	-
Cylindre TRANSIT 2 30 x 55 mm nickelé 3 clés	00018815 <small>NS</small>	1	-	-	-	-	-	-	-	-	-	-	-
Cylindre TRANSIT 2 30 x 60 mm nickelé 3 clés	00018816 <small>NS</small>	1	-	-	-	-	-	-	-	-	-	-	-

NS Non stocké/Non-stored/Productos no estocado - ■ Sur stock Europe Zone 1 et Zone 2, nous consulter pour délai d'approvisionnement - ■ Epuement/Stock depletion/Agotamiento del stock





Designation	Boîte	Colis.	Prix	Sachet	Colis.	Prix	Brochable					Colis.	Prix
							France	Euro 1	Euro 2	Euro 3	Euro 4		
Cylindre TRANSIT 2 30 x 65 mm nickelé 3 clés	00018817 NS	1	-	-	-	-	-	-	-	-	-	-	-
Cylindre TRANSIT 2 30 x 70 mm nickelé 3 clés	00018818 NS	1	-	-	-	-	-	-	-	-	-	-	-
Cylindre TRANSIT 2 30 x 80 mm nickelé 3 clés	00018819 NS	1	-	-	-	-	-	-	-	-	-	-	-
Cylindre TRANSIT 2 35 x 35 mm nickelé 3 clés	00018820 NS	1	-	-	-	-	-	-	-	-	-	-	-
Cylindre TRANSIT 2 35 x 40 mm nickelé 3 clés	00018821 NS	1	-	-	-	-	-	-	-	-	-	-	-
Cylindre TRANSIT 2 35 x 45 mm nickelé 3 clés	00018822 NS	1	-	-	-	-	-	-	-	-	-	-	-
Cylindre TRANSIT 2 35 x 50 mm nickelé 3 clés	00018823 NS	1	-	-	-	-	-	-	-	-	-	-	-
Cylindre TRANSIT 2 35 x 55 mm nickelé 3 clés	00018824 NS	1	-	-	-	-	-	-	-	-	-	-	-
Cylindre TRANSIT 2 35 x 60 mm nickelé 3 clés	00018825 NS	1	-	-	-	-	-	-	-	-	-	-	-
Cylindre TRANSIT 2 35 x 70 mm nickelé 3 clés	00018826 NS	1	-	-	-	-	-	-	-	-	-	-	-
Cylindre TRANSIT 2 40 x 40 mm nickelé 3 clés	00018830 NS	1	-	-	-	-	-	-	-	-	-	-	-
Cylindre TRANSIT 2 40 x 45 mm nickelé 3 clés	00018831 NS	1	-	-	-	-	-	-	-	-	-	-	-
Cylindre TRANSIT 2 40 x 50 mm nickelé 3 clés	00018832 NS	1	-	-	-	-	-	-	-	-	-	-	-
Cylindre TRANSIT 2 40 x 55 mm nickelé 3 clés	00018833 NS	1	-	-	-	-	-	-	-	-	-	-	-
Cylindre TRANSIT 2 40 x 60 mm nickelé 3 clés	00018834 NS	1	-	-	-	-	-	-	-	-	-	-	-
Cylindre TRANSIT 2 40 x 70 mm nickelé 3 clés	00018835 NS	1	-	-	-	-	-	-	-	-	-	-	-
Cylindre TRANSIT 2 45 x 45 mm nickelé 3 clés	00018836 NS	1	-	-	-	-	-	-	-	-	-	-	-
Cylindre TRANSIT 2 45 x 50 mm nickelé 3 clés	00018837 NS	1	-	-	-	-	-	-	-	-	-	-	-
Cylindre TRANSIT 2 45 x 55 mm nickelé 3 clés	00018838 NS	1	-	-	-	-	-	-	-	-	-	-	-
Cylindre TRANSIT 2 45 x 60 mm nickelé 3 clés	00018839 NS	1	-	-	-	-	-	-	-	-	-	-	-
Cylindre TRANSIT 2 45 x 70 mm nickelé 3 clés	00018840 NS	1	-	-	-	-	-	-	-	-	-	-	-
Cylindre TRANSIT 2 50 x 50 mm nickelé 3 clés	00018841 NS	1	-	-	-	-	-	-	-	-	-	-	-
Cylindre TRANSIT 2 50 x 55 mm nickelé 3 clés	00018842 NS	1	-	-	-	-	-	-	-	-	-	-	-
Cylindre TRANSIT 2 50 x 60 mm nickelé 3 clés	00018843 NS	1	-	-	-	-	-	-	-	-	-	-	-
Cylindre TRANSIT 2 55 x 55 mm nickelé 3 clés	00018844 NS	1	-	-	-	-	-	-	-	-	-	-	-
Cylindre TRANSIT 2 55 x 60 mm nickelé 3 clés	00018845 NS	1	-	-	-	-	-	-	-	-	-	-	-

Cylindre de haute sûreté / TRANSIT 2 POUR ORGANIGRAMME RESIST



NIVEAU DE SÉCURITÉ



Designation	Boite	Colis.	Prix	Sachet	Colis.	Prix	Brochable					Colis.	Prix
							France	Euro 1	Euro 2	Euro 3	Euro 4		
Cylindre TRANSIT 2 60 x 60 mm nickelé 3 clés	00018846 <small>NS</small>	1	-	-	-	-	-	-	-	-	-	-	-
Cylindre TRANSIT 2 à bouton 30 x 30 mm nickelé 3 clés	00018860 <small>NS</small>	1	-	-	-	-	-	-	-	-	-	-	-
Cylindre TRANSIT 2 à bouton 30 x 35 mm nickelé 3 clés	00018861 <small>NS</small>	1	-	-	-	-	-	-	-	-	-	-	-
Cylindre TRANSIT 2 à bouton 30 x 40 mm nickelé 3 clés	00018862 <small>NS</small>	1	-	-	-	-	-	-	-	-	-	-	-
Cylindre TRANSIT 2 à bouton 30 x 45 mm nickelé 3 clés	00018863 <small>NS</small>	1	-	-	-	-	-	-	-	-	-	-	-
Cylindre TRANSIT 2 à bouton 30 x 50 mm nickelé 3 clés	00018864 <small>NS</small>	1	-	-	-	-	-	-	-	-	-	-	-
Cylindre TRANSIT 2 à bouton 30 x 55 mm nickelé 3 clés	00018865 <small>NS</small>	1	-	-	-	-	-	-	-	-	-	-	-
Cylindre TRANSIT 2 à bouton 30 x 60 mm nickelé 3 clés	00018866 <small>NS</small>	1	-	-	-	-	-	-	-	-	-	-	-
Cylindre TRANSIT 2 à bouton 30 x 65 mm nickelé 3 clés	00018867 <small>NS</small>	1	-	-	-	-	-	-	-	-	-	-	-
Cylindre TRANSIT 2 à bouton 30 x 70 mm nickelé 3 clés	00018868 <small>NS</small>	1	-	-	-	-	-	-	-	-	-	-	-
Cylindre TRANSIT 2 à bouton 35 x 30 mm nickelé 3 clés	00018871 <small>NS</small>	1	-	-	-	-	-	-	-	-	-	-	-
Cylindre TRANSIT 2 à bouton 35 x 35 mm nickelé 3 clés	00018872 <small>NS</small>	1	-	-	-	-	-	-	-	-	-	-	-
Cylindre TRANSIT 2 à bouton 35 x 40 mm nickelé 3 clés	00018873 <small>NS</small>	1	-	-	-	-	-	-	-	-	-	-	-
Cylindre TRANSIT 2 à bouton 35 x 45 mm nickelé 3 clés	00018874 <small>NS</small>	1	-	-	-	-	-	-	-	-	-	-	-
Cylindre TRANSIT 2 à bouton 35 x 50 mm nickelé 3 clés	00018875 <small>NS</small>	1	-	-	-	-	-	-	-	-	-	-	-
Cylindre TRANSIT 2 à bouton 35 x 55 mm nickelé 3 clés	00018876 <small>NS</small>	1	-	-	-	-	-	-	-	-	-	-	-
Cylindre TRANSIT 2 à bouton 35 x 60 mm nickelé 3 clés	00018877 <small>NS</small>	1	-	-	-	-	-	-	-	-	-	-	-
Cylindre TRANSIT 2 à bouton 35 x 70 mm nickelé 3 clés	00018878 <small>NS</small>	1	-	-	-	-	-	-	-	-	-	-	-
Cylindre TRANSIT 2 à bouton 40 x 30 mm nickelé 3 clés	00018881 <small>NS</small>	1	-	-	-	-	-	-	-	-	-	-	-
Cylindre TRANSIT 2 à bouton 40 x 35 mm nickelé 3 clés	00018882 <small>NS</small>	1	-	-	-	-	-	-	-	-	-	-	-
Cylindre TRANSIT 2 à bouton 40 x 40 mm nickelé 3 clés	00018883 <small>NS</small>	1	-	-	-	-	-	-	-	-	-	-	-
Cylindre TRANSIT 2 à bouton 40 x 45 mm nickelé 3 clés	00018884 <small>NS</small>	1	-	-	-	-	-	-	-	-	-	-	-
Cylindre TRANSIT 2 à bouton 40 x 50 mm nickelé 3 clés	00018885 <small>NS</small>	1	-	-	-	-	-	-	-	-	-	-	-
Cylindre TRANSIT 2 à bouton 40 x 55 mm nickelé 3 clés	00018886 <small>NS</small>	1	-	-	-	-	-	-	-	-	-	-	-
Cylindre TRANSIT 2 à bouton 40 x 60 mm nickelé 3 clés	00018887 <small>NS</small>	1	-	-	-	-	-	-	-	-	-	-	-
Cylindre TRANSIT 2 à bouton 40 x 70 mm nickelé 3 clés	00018888 <small>NS</small>	1	-	-	-	-	-	-	-	-	-	-	-



NS Non stocké/Non-stored/Productos no estocado - ☑ Sur stock Europe Zone 1 et Zone 2, nous consulter pour délai d'approvisionnement - Ⓔ Epuement/Stock depletion/Agotamiento del stock

Cylindre de haute sûreté / SURVEYOR RESIST



NIVEAU DE SÉCURITÉ



GARANTIE



X 4



Protection
Arrachement



Protection
Crochetage

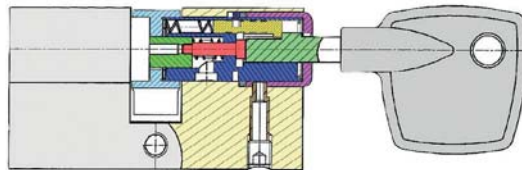

Description/Description/Descripción

Profil européen laiton. Mécanisme à pompes à 5 éléments de verrouillage. Panneton anti arrachement. 4 clés à insert laiton avec carte personnelle.

European brass profile. 5 tumbler mechanism. Driver cam made of powdered metal. 4 pump keys with a personal security card for key copies.

Perfil europeo de latón. Mecanismo de bombas con 5 elementos de cierre. Pivote de acero sinterizado antiarrancamiento. 4 llaves de bombas con título de propiedad que permite su reproducción en fábrica

Finition/Finish/Acabado

Laiton
Brass
Latón

Version/Option/Versión

Demi-cylindre. Cylindre 2 entrées. Cylindre 1 entrée à bouton. Batteuse.

1/2 cylinder with key way. Cylinder with 2 key ways.

Cylinder with key way and inside knob. Cam lock.

Semicilindro. Cilindro 2 entradas. Cilindro 1 entrada de botón. Cerradura.

Cylindre de haute sûreté / SURVEYOR RESIST



NIVEAU DE SÉCURITÉ

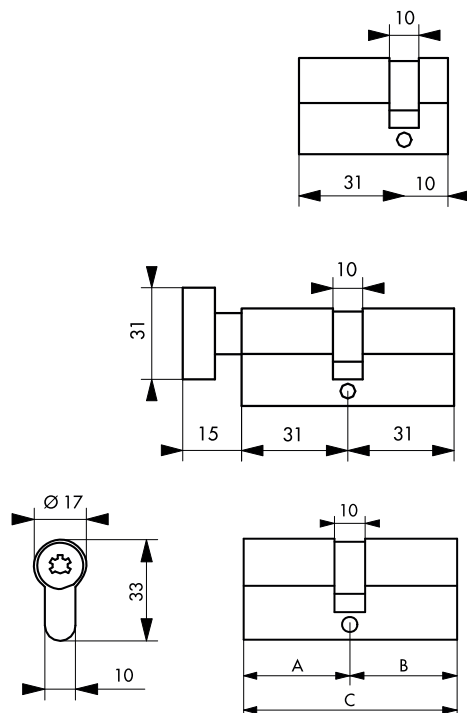

	31x31	36x36	41x41	31x41	31x61	31x66
A	31	36	41	31	31	31
B	31	36	41	41	61	66
C	62	72	82	72	92	97

Designation	Boite	Colis.	Prix	Sachet	Colis.	Prix	Brochable					Colis.	Prix
							France	Euro 1	Euro 2	Euro 3	Euro 4		
Demi-cylindre SURVEYOR 31 x 10 mm 4 clés	00016729	1	-	-	-	-	-	-	-	-	-	-	-
Cylindre SURVEYOR 31 x 31 mm 4 clés	00016730	1	-	-	-	-	00216730	00293162 NS	00292162 NS	00294162	-	5	-
Cylindre SURVEYOR 36 x 36 mm 4 clés	00016736	1	-	-	-	-	-	-	-	-	-	-	-
Cylindre SURVEYOR 41 x 41 mm 4 clés	00016741	1	-	-	-	-	-	-	-	-	-	-	-
Cylindre SURVEYOR 31 x 41 mm 4 clés	00016732	1	-	-	-	-	00216732	-	-	-	-	5	-
Cylindre SURVEYOR 31 x 61 mm 4 clés	00016761	1	-	-	-	-	-	-	-	-	-	-	-
Cylindre SURVEYOR 31 x 66 mm 4 clés	00016766	1	-	-	-	-	-	-	-	-	-	-	-
Cylindre SURVEYOR à bouton 31 x 31 mm 4 clés	00016733	1	-	-	-	-	-	-	-	-	-	-	-

NS Non stocké/Non-stored/Producto no estocado - Sur stock Europe Zone 1 et Zone 2, nous consulter pour délai d'approvisionnement - E Epuisement/Stock depletion/Agotamiento del stock

Cylindre de haute sûreté / COBRA 2 / COBRA 2+ ÉVOLUTION RESIST



NIVEAU DE SÉCURITÉ



GARANTIE



X 4

Système modulaire à pompes
avec poutre anticasse et
protection antiperçage.



Protection
Arrachement



Protection
Perçage



Protection
Crochetage



Protection
Casse

Cylindre conforme à la norme

EN 1303:2015
Classification

16000B62

Description/Description/Descripción

Profil européen laiton. Mécanisme à 5 pompes de sécurité axiales équipées de faux-crans contre le crochetage et 1 pompe radiale. Protection contre la casse par poutre en acier. Panneton anti arrachement. 5 clés ergonomiques brevetées avec carte de propriété pour la reproduction exclusive en usine (livrée avec 4 clés sous conditionnement coque). COBRA 2+ : Protection contre le perçage par éléments en carbures

European brass profile. Pin tumbler mechanism with 5 top pins ensuring pick resistance and 1 radial pin. Steel girder protecting against damage, anti-wrench bit. 4 patented keys with a personal security card for key copies only in factory (5 keys under blister packing). COBRA 2+ : carbide components providing drill resistance.

Perfil europeo latón. Mecanismo de 5 bombas axiales equipadas de muescas falsas contra el forzamiento y 1 bomba radial. 4 llaves patentadas con título de propiedad que garantiza su reproducción únicamente en fábrica (5 llaves suministrado en embalaje blister). COBRA 2+ : Protección contra el taladrado mediante elementos de carburo.

Finition/Finish/Acabado

Nickel velours
Dull nickel plated
Níquel terciopelo

Version/Option/Versión

Demi-cylindre. Cylindre 2 entrées. Cylindre à bouton 1 entrée. Panneton orientable pour la dimension 33x10mm. (autres dimensions sur demande). Batteuse. Barillet contacteur.

1/2 cylinder with key way. Cylinder with 2 key ways. Cylinder with key way and inside knob. With adjustable driver came for 33x10mm. (other dimensions on request). Cam lock. Key controlled contactor.

Semicilindro. Cilindro 2 entradas. Cilindro 1 entrada de botón. Paletón orientable para el dimension 33x10mm (otras dimensiones sobre demanda). Cerradura. Contactor de mando.



Réf : 217730 - 5 clés ABS sous conditionnement Blister

Cylindre de haute sûreté / COBRA 2 / COBRA 2+ ÉVOLUTION

RESIST



NIVEAU DE SÉCURITÉ



Designation	Boite	Colis.	Prix	Sachet	Colis.	Prix	Brochable					Colis.	Prix
							France	Euro 1	Euro 2	Euro 3	Euro 4		
Demi-cylindre COBRA 2 Évolution 33 x 10 mm panneton orientable	00040331 <small>NS</small>	1	-	-	-	-	-	-	-	-	-	-	-
Cylindre COBRA 2 Évolution 33 x 33 mm	00040660	1	-	-	-	-	-	00293991 <small>☐</small>	-	-	-	5	-
Cylindre COBRA 2 Évolution 38 x 38 mm	00040760 <small>NS</small>	1	-	-	-	-	-	-	-	-	-	-	-
Cylindre COBRA 2 Évolution 43 x 43 mm	00040860 <small>NS</small>	1	-	-	-	-	-	-	-	-	-	-	-
Cylindre COBRA 2 Évolution 33 x 43 mm	00040810 <small>NS</small>	1	-	-	-	-	-	-	-	-	-	-	-
Cylindre COBRA 2 Évolution 33 x 53 mm	00040861 <small>NS</small>	1	-	-	-	-	-	-	-	-	-	-	-
Cylindre COBRA 2 Évolution 33 x 63 mm	00040960 <small>NS</small>	1	-	-	-	-	-	-	-	-	-	-	-
Cylindre COBRA 2 Évolution 33 x 68 mm	00040111 <small>NS</small>	1	-	-	-	-	-	-	-	-	-	-	-
Cylindre COBRA 2 Évolution 38 x 48 mm	00040862 <small>NS</small>	1	-	-	-	-	-	-	-	-	-	-	-
Cylindre COBRA 2 Évolution à bouton 33BT x 33 mm	00040661	1	-	-	-	-	-	00293992 <small>☐</small>	-	-	-	5	-
Cylindre COBRA 2 Évolution à bouton 33BT x 43 mm	00040761 <small>NS</small>	1	-	-	-	-	-	-	-	-	-	-	-



Designation	Boite	Colis.	Prix	Sachet	Colis.	Prix	Brochable					Colis.	Prix
							France	Euro 1	Euro 2	Euro 3	Euro 4		
Demi-cylindre COBRA 2+ Évolution 33 x 10 mm panneton orientable	00041331 <small>NS</small>	1	-	-	-	-	-	-	-	-	-	-	-
Cylindre COBRA 2+ Évolution 33 x 33 mm	00041660	1	-	-	-	-	00217730	00293163 <small>☐</small>	00292163 <small>☐</small>	00294163	-	5	-
Cylindre COBRA 2+ Évolution 38 x 38 mm	00041760 <small>NS</small>	1	-	-	-	-	-	00293445 <small>☐</small>	-	00294430	-	5	-
Cylindre COBRA 2+ Évolution 43 x 43 mm	00041860 <small>NS</small>	1	-	-	-	-	-	00293446 <small>☐</small>	-	00294431	-	5	-
Cylindre COBRA 2+ Évolution 33 x 43 mm	00041810 <small>NS</small>	1	-	-	-	-	00217732	00293448 <small>☐</small>	00292448 <small>☐</small>	00294432	-	5	-
Cylindre COBRA 2+ Évolution 33 x 53 mm	00041861 <small>NS</small>	1	-	-	-	-	-	-	-	00294433	-	5	-
Cylindre COBRA 2+ Évolution 33 x 63 mm	00041960 <small>NS</small>	1	-	-	-	-	-	-	-	-	-	-	-
Cylindre COBRA 2+ Évolution 33 x 68 mm	00041101 <small>NS</small>	1	-	-	-	-	-	-	-	-	-	-	-
Cylindre COBRA 2+ Évolution 38 x 48 mm	00041862 <small>NS</small>	1	-	-	-	-	-	-	-	-	-	-	-
Cylindre COBRA 2+ Évolution à bouton 33BT x 33 mm	00041661	1	-	-	-	-	00293190	-	-	-	-	5	-
Cylindre COBRA 2+ Évolution à bouton 33BT x 43 mm	00041761 <small>NS</small>	1	-	-	-	-	-	-	-	-	-	-	-
Cylindre COBRA 2+ Évolution à bouton 43BT x 33 mm	-	-	-	-	-	-	00293191	-	-	-	-	5	-

NS Non stocké/Non-stored/Productos no estocados - ☐ Sur stock Europe Zone 1 et Zone 2, nous consulter pour délai d'approvisionnement - E Epuement/Stock depletion/Agotamiento del stock

Cylindre de haute sûreté / FEDERAL PROTECT



NIVEAU DE SÉCURITÉ



GARANTIE



X 4



Protection
Arrachement



Protection
Perçage



Protection
Crochetage



Protection
Casse



Mécanisme magnétique protégé contre l'arrachement, le perçage, le crochetage et la casse.

Description/Description/Descripción

Profil européen laiton. Mécanisme à 3 ou 4 doubles goupilles télescopiques + 1 goupille magnétique. Protection contre le perçage par aiguille en acier trempé. Protection contre la casse par poutre acier. Panneton anti arrachement. 4 clés plates réversibles maillechort avec anneau ergonomique moulé, avec carte de propriété permettant la reproduction des clés exclusivement en usine.

European brass profile. Magnetic 3 to 4 double telescopic pin mechanism + 1 magnetic pin. Protection against drilling by hardened steel pin. Protection against breaking by steel bar. 4 reversible keys with a personal security card for key copies

Perfil europeo de latón. Mecanismo de 3 ó 4 pasadores + 1 pasador magnético. Protección contra el taladrado por medio de una aguja de acero templado. Protección contra la rotura mediante una viga de acero. Pivote de acero sinterizado antiarrancamiento. 4 llaves planas reversibles de alpaca con anillo ergonómico moldeado y título de propiedad que permite su reproducción en fábrica.

Finition/Finish/Acabado

Nickelé mat
Nickel plated matt
Niquelado mate

Version/Option/Versión

Demi-cylindre. Cylindre 2 entrées. Cylindre à bouton 1 entrée.

1/2 cylinder with key way. Cylinder with 2 key ways. Cylinder with key way and inside knob.

Semicilindro. Cilindro de 2 entradas. Cilindro de botón de 1 entrada.



NIVEAU DE SÉCURITÉ

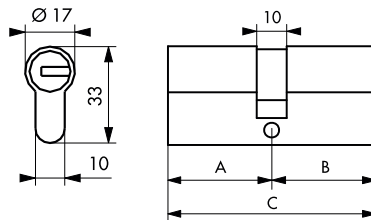
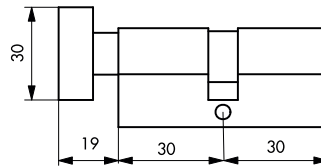
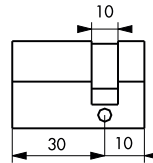

	30x30	30x40	30x60	30x65
A	30	30	30	30
B	30	40	60	65
C	60	70	90	95

Designation	Boite	Colis.	Prix	Sachet	Colis.	Prix	Brochable					Colis.	Prix
							France	Euro 1	Euro 2	Euro 3	Euro 4		
Demi-cylindre FEDERAL 30 x 10 mm 4 clés	00003310	1	-	-	-	-	00203310	-	00292422 NS	-	-	5	-
Cylindre FEDERAL 30 x 30 mm 4 clés	00003330	1	-	-	-	-	00203330	00293176 NS	00292176 NS	00294176	-	5	-
Cylindre FEDERAL 30 x 40 mm 4 clés	00003340	1	-	-	-	-	00203340	-	00292423 NS	-	-	5	-
Cylindre FEDERAL 30 x 60 mm 4 clés	00003360	1	-	-	-	-	00203360	-	00292424 NS	-	-	5	-
Cylindre FEDERAL 30 x 65 mm 4 clés	00003365	1	-	-	-	-	00203365	-	-	-	-	5	-
Cylindre FEDERAL à bouton 30BT x 30 mm 4 clés	00003333	1	-	-	-	-	00203333	-	-	-	-	5	-

NS Non stocké/Non-stored/Producto no estocado - Sur stock Europe Zone 1 et Zone 2, nous consulter pour délai d'approvisionnement - E Epuisement/Stock depletion/Agotamiento del stock

Cylindre de haute sûreté / FEDERAL S RESIST



NIVEAU DE SÉCURITÉ



GARANTIE



X 5



Protection
Arrachement



Protection
Perçage



Protection
Crochetage



Protection
Casse



Protection
Snap



Protection
Bumping

Description/Description/Descripción

Profil européen laiton. Mécanisme à 3 ou 4 doubles goupilles télescopiques + 1 goupille magnétique. Protection contre le perçage par aiguille en acier trempé. Goupilles «Trap pin» contre l'effraction par blocage du rotor. Protection contre l'effraction de la partie saillante du cylindre (anti-snap). Protection contre le bumping. Panneton anti arrachement. 5 clés plates réversibles maillechort avec carte de propriété permettant la reproduction des clés exclusivement en usine. *European brass profile. Magnetic 3 to 4 double telescopic pin mechanism. Protection against drilling by hardened steel pin. Trap pin. Protection against the intrusion of the projecting portion of the cylinder (anti-snap). Anti bump. Driver cam made of powdered metal. 5 reversible keys with a personal security card for key copies.*

Perl europeo de latón. Mecanismo de 3 ó 4 pasadores + 1 pasador magnético. Protección contra el taladrado por medio de una aguja de acero templado. Pivote de acero sinterizado antiarrancamiento. Protección contra la manipulación de la parte saliente del cilindro. 5 llaves planas reversibles de alpaca y título de propiedad que permite su reproducción en fábrica.

Finition/Finish/Acabado

Nickelé satin

Satin nickel

Niquel satinado

Versión/Option/Versión

Demi-cylindre. Cylindre 2 entrées. Cylindre à bouton 1 entrée.

1/2 cylinder with key way. Cylinder with 2 key ways.

Cylinder with key way and inside knob.

Semicilindro. Cilindro de 2 entradas. Cilindro de botón de 1 entrada.

Cylindre de haute sûreté / FEDERAL S RESIST



NIVEAU DE SÉCURITÉ



Cylindre conforme à la norme

EN 1303:2015

Classification

1 6 0 0 0 C 5 0

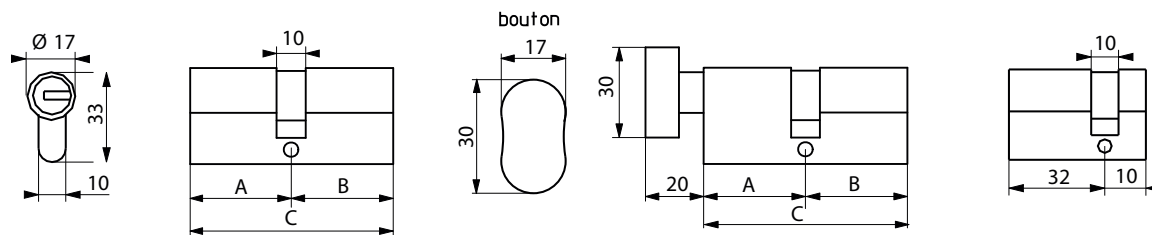

	32x32	37x37	42x42	32x42	32x50	32x60	32x65	37x45
A	32	37	42	32	32	32	32	37
B	32	37	42	42	50	60	65	45
C	64	74	84	74	82	92	97	82



Designation	Boîte	Colis.	Prix	Sachet	Colis.	Prix	Brochable					Colis.	Prix
							France	Euro 1	Euro 2	Euro 3	Euro 4		
Cylindre Federal S - 32x10mm SN 5 clés	00003710	1	-	-	-	-	00203710	00293730 NS	00292730 NS	00294730	-	5	-
Cylindre Federal S - 32x32mm SN 5 clés	00003730	1	-	-	-	-	00203730	00293731 NS	00292731 NS	00294731	-	5	-
Cylindre Federal S - 37x37mm SN 5 clés	00003735	1	-	-	-	-	00203735	00293736 NS	00292736 NS	00294736	-	5	-
Cylindre Federal S - 42x42mm SN 5 clés	00003780	1	-	-	-	-	00203780	00293738 NS	00292738 NS	00294738	-	5	-
Cylindre Federal S - 32x42mm SN 5 clés	00003740	1	-	-	-	-	00203740	00293732 NS	00292732 NS	00294732	-	5	-
Cylindre Federal S - 32x50mm SN 5 clés	00003750	1	-	-	-	-	00203750	00293733 NS	00292733 NS	00294733	-	5	-
Cylindre Federal S - 32x60mm SN 5 clés	00003760	1	-	-	-	-	00203760	00293734 NS	00292734 NS	00294734	-	5	-
Cylindre Federal S - 32x65mm SN 5 clés	00003765	1	-	-	-	-	00203765	00293735 NS	00292735 NS	00294735	-	5	-
Cylindre Federal S - 37x45mm SN 5 clés	00003745	1	-	-	-	-	00203745	00293737 NS	00292737 NS	00294737	-	5	-
Cylindre Federal S - à bouton 32x32mm SN 5 clés	00003733	1	-	-	-	-	00203733	00293739 NS	00292739 NS	00294739	-	5	-
Cylindre Federal S - à bouton 32x42mm SN 5 clés	00003734	1	-	-	-	-	00203734	00293729 NS	00292729 NS	00294729	-	5	-

NS Non stocké/Non-stored/Producto no estocado - Sur stock Europe Zone 1 et Zone 2, nous consulter pour délai d'approvisionnement - E Epuïsement/Stock depletion/Agotamiento del stock

Cylindre de haute sûreté / FEDERAL 2 RESIST



NIVEAU DE SÉCURITÉ



GARANTIE



X 5



Protection Arrachement



Protection Perçage



Protection Crochetage



Protection Casse



Protection Snap



Protection Bumping

Description/Description/Descripción

Profil européen laiton. Mécanisme à 3 ou 4 doubles goupilles télescopiques + 1 goupille magnétique. Protection contre le perçage par aiguille en acier trempé. Goupilles «Trap pin» contre l'effraction par blocage du rotor. Connecteur en acier au molybdène breveté contre la casse. Protection contre l'effraction de la partie saillante du cylindre (anti-snap). Protection contre le bumping. Panneton anti arrachement. 5 clés plates réversibles maillechort avec anneau ergonomique moulé, avec carte de propriété permettant la reproduction des clés exclusivement en usine.

European brass profile. Magnetic 3 to 4 double telescopic pin mechanism. Protection against drilling by hardened steel pin. Trap pin. Protection against breaking by molybdenum steel bar. Protection against the intrusion of the projecting portion of the cylinder (anti-snap). Anti bump. Driver cam made of powdered metal. 5 reversible keys with a personal security card for key copies
 Perfil europeo de latón. Mecanismo de 3 ó 4 pasadores + 1 pasador magnético. Protección contra el taladrado por medio de una aguja de acero templado. Protección contra la rotura mediante una viga de acero. Pivote de acero sinterizado antiarrancamiento. Protección contra la manipulación de la parte saliente de cilindro. 5 llaves planas reversibles de alpaca con anillo ergonómico moldeado y título de propiedad que permite su reproducción en fábrica.

Finition/Finish/Acabado

Nickelé mat
Nickel plated matt
 Niquelado mate

Version/Option/Versión

Demi-cylindre. Cylindre 2 entrées. Cylindre à bouton 1 entrée.
1/2 cylinder with key way. Cylinder with 2 key ways. Cylinder with key way and inside knob.
 Semicilindro. Cilindro de 2 entradas. Cilindro de botón de 1 entrada.

Les + : Trap pin - goupilles contre l'effraction par blocage du rotor.

Connecteur breveté en acier au molybdène contre la casse.

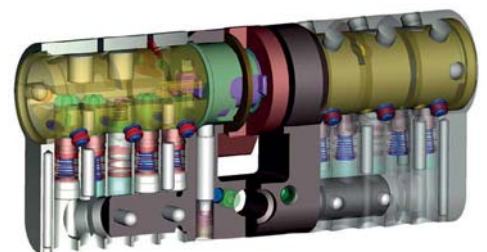

Cylindre de haute sûreté / FEDERAL 2 RESIST



NIVEAU DE SÉCURITÉ



Cylindre conforme à la norme

EN 1303:2015

Classification

1 6 0 0 0 C 5 0

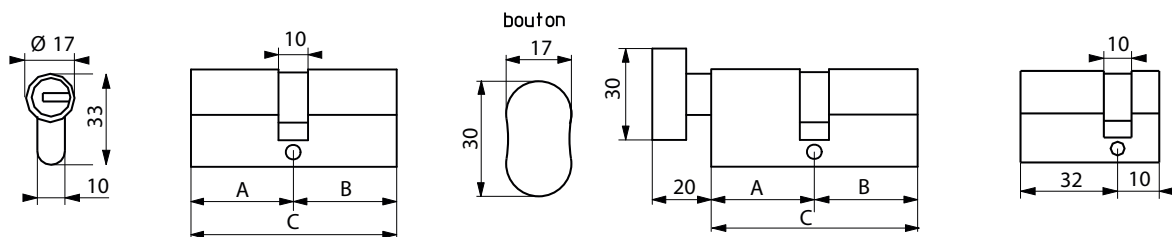

	32x32	37x37	42x42	32x42	32x50	32x60	32x65	37x45
A	32	37	42	32	32	32	32	37
B	32	37	42	42	50	60	65	45
C	64	74	84	74	82	92	97	82

Designation	Boite	Colis.	Prix	Sachet	Colis.	Prix	Brochable					Colis.	Prix
							France	Euro 1	Euro 2	Euro 3	Euro 4		
Demi-cylindre FEDERAL 2 32 x 10 mm 5 clés	00003410	1	-	-	-	-	00203410	-	-	00294842	-	5	-
Cylindre FEDERAL 2 32 x 32 mm 5 clés	00003430	1	-	-	-	-	00203430	00293843 NS	00292843 NS	00294843	-	5	-
Cylindre FEDERAL 2 37 x 37 mm 5 clés	00003435	1	-	-	-	-	00203435	-	-	00294844	-	5	-
Cylindre FEDERAL 2 42 x 42 mm 5 clés	00003489	1	-	-	-	-	00203489	00293845 NS	00292845 NS	00294845	-	5	-
Cylindre FEDERAL 2 32 x 37 mm 5 clés	00003484	1	-	-	-	-	-	-	-	-	-	-	-
Cylindre FEDERAL 2 32 x 42 mm 5 clés	00003440	1	-	-	-	-	00203440	-	00292846 NS	00294846	-	5	-
Cylindre FEDERAL 2 32 x 45 mm 5 clés	00003485	1	-	-	-	-	-	-	-	-	-	-	-
Cylindre FEDERAL 2 32 x 50 mm 5 clés	00003480	1	-	-	-	-	00203480	-	-	00294847	-	5	-
Cylindre FEDERAL 2 32 x 60 mm 5 clés	00003460	1	-	-	-	-	00203460	-	-	00294848	-	5	-
Cylindre FEDERAL 2 32 x 65 mm 5 clés	00003465	1	-	-	-	-	00203465	-	-	00294849	-	5	-
Cylindre FEDERAL 2 37 x 45 mm 5 clés	00003481	1	-	-	-	-	00203481	-	-	00294866	-	5	-
Cylindre FEDERAL 2 42 x 50 mm 5 clés	00003486	1	-	-	-	-	-	-	-	-	-	-	-
Cylindre FEDERAL 2 à bouton 32BT x 32 mm 5 clés	00003433	1	-	-	-	-	00203433	00293867 NS	00292867 NS	00294867	-	5	-
Cylindre FEDERAL 2 à bouton 32BT x 42 mm 5 clés	00003434	1	-	-	-	-	00203434	00293868 NS	00292868 NS	00294868	-	5	-
Cylindre FEDERAL 2 à bouton 32BT x 60 mm 5 clés	00003482	1	-	-	-	-	-	-	-	-	-	-	-
Cylindre FEDERAL 2 à bouton 42BT x 32 mm 5 clés	-	-	-	-	-	-	00203436	-	-	-	-	5	-

NS Non stocké/Non-stored/Producto no estocado - Sur stock Europe Zone 1 et Zone 2, nous consulter pour délai d'approvisionnement - E Epuïsement/Stock depletion/Agotamiento del stock



Cylindre de haute sûreté / FEDERAL 2 POUR ORGANIGRAMME RESIST



NIVEAU DE SÉCURITÉ



GARANTIE



X 3



Designation	Boîte	Colis.	Prix	Sachet	Colis.	Prix	Brochable					Colis.	Prix
							France	Euro 1	Euro 2	Euro 3	Euro 4		
Cylindre FEDERAL 2 32 X 10 mm 3 clés	00003411 NS	1	-	-	-	-	-	-	-	-	-	-	-
Cylindre FEDERAL 2 37 X 10 mm 3 clés	00003412 NS	1	-	-	-	-	-	-	-	-	-	-	-
Cylindre FEDERAL 2 42 X 10 mm 3 clés	00003413 NS	1	-	-	-	-	-	-	-	-	-	-	-
Cylindre FEDERAL 2 45 X 10 mm 3 clés	00003414 NS	1	-	-	-	-	-	-	-	-	-	-	-
Cylindre FEDERAL 2 50 X 10 mm 3 clés	00003415 NS	1	-	-	-	-	-	-	-	-	-	-	-
Cylindre FEDERAL 2 55 X 10 mm 3 clés	00003416 NS	1	-	-	-	-	-	-	-	-	-	-	-
Cylindre FEDERAL 2 60 X 10 mm 3 clés	00003417 NS	1	-	-	-	-	-	-	-	-	-	-	-
Cylindre FEDERAL 2 32 X 32 mm 3 clés	00003418 NS	1	-	-	-	-	-	-	-	-	-	-	-
Cylindre FEDERAL 2 32 X 37 mm 3 clés	00003484 NS	1	-	-	-	-	-	-	-	-	-	-	-
Cylindre FEDERAL 2 32 X 42 mm 3 clés	00003420 NS	1	-	-	-	-	-	-	-	-	-	-	-
Cylindre FEDERAL 2 32 X 45 mm 3 clés	00003421 NS	1	-	-	-	-	-	-	-	-	-	-	-
Cylindre FEDERAL 2 32 X 50 mm 3 clés	00003422 NS	1	-	-	-	-	-	-	-	-	-	-	-
Cylindre FEDERAL 2 32 X 55 mm 3 clés	00003423 NS	1	-	-	-	-	-	-	-	-	-	-	-
Cylindre FEDERAL 2 37 X 37 mm 3 clés	00003425 NS	1	-	-	-	-	-	-	-	-	-	-	-
Cylindre FEDERAL 2 37 X 42 mm 3 clés	00003426 NS	1	-	-	-	-	-	-	-	-	-	-	-
Cylindre FEDERAL 2 37 X 45 mm 3 clés	00003427 NS	1	-	-	-	-	-	-	-	-	-	-	-
Cylindre FEDERAL 2 37 X 50 mm 3 clés	00003428 NS	1	-	-	-	-	-	-	-	-	-	-	-
Cylindre FEDERAL 2 37 X 55 mm 3 clés	00003429 NS	1	-	-	-	-	-	-	-	-	-	-	-
Cylindre FEDERAL 2 42 X 42 mm 3 clés	00003431 NS	1	-	-	-	-	-	-	-	-	-	-	-

NS Non stocké/Non-stored/Producto no estocado - ☐ Sur stock Europe Zone 1 et Zone 2, nous consulter pour délai d'approvisionnement - ☒ Epuisement/Stock depletion/Agotamiento del stock

Cylindre de haute sûreté / FEDERAL 2 POUR ORGANIGRAMME RESIST



NIVEAU DE SÉCURITÉ



Designation	Boîte	Colis.	Prix	Sachet	Colis.	Prix	Brochable					Colis.	Prix
							France	Euro 1	Euro 2	Euro 3	Euro 4		
Cylindre FEDERAL 2 42 X 45 mm 3 clés	00003432 NS	1	-	-	-	-	-	-	-	-	-	-	-
Cylindre FEDERAL 2 42 X 50 mm 3 clés	00003406 NS	1	-	-	-	-	-	-	-	-	-	-	-
Cylindre FEDERAL 2 42 X 55 mm 3 clés	00003437 NS	1	-	-	-	-	-	-	-	-	-	-	-
Cylindre FEDERAL 2 42 X 60 mm 3 clés	00003438 NS	1	-	-	-	-	-	-	-	-	-	-	-
Cylindre FEDERAL 2 45 X 45 mm 3 clés	00003439 NS	1	-	-	-	-	-	-	-	-	-	-	-
Cylindre FEDERAL 2 45 X 50 mm 3 clés	00003441 NS	1	-	-	-	-	-	-	-	-	-	-	-
Cylindre FEDERAL 2 45 X 55 mm 3 clés	00003442 NS	1	-	-	-	-	-	-	-	-	-	-	-
Cylindre FEDERAL 2 50 X 50 mm 3 clés	00003443 NS	1	-	-	-	-	-	-	-	-	-	-	-
Cylindre FEDERAL 2 50 X 55 mm 3 clés	00003444 NS	1	-	-	-	-	-	-	-	-	-	-	-
Cylindre FEDERAL 2 50 X 60 mm 3 clés	00003445 NS	1	-	-	-	-	-	-	-	-	-	-	-
Cylindre FEDERAL 2 à bouton 32BT X 32 mm 3 clés	00003446 NS	1	-	-	-	-	-	-	-	-	-	-	-
Cylindre FEDERAL 2 à bouton 32BT X 37 mm 3 clés	00003447 NS	1	-	-	-	-	-	-	-	-	-	-	-
Cylindre FEDERAL 2 à bouton 32BT X 60 mm 3 clés	00003482 NS	1	-	-	-	-	-	-	-	-	-	-	-
Cylindre FEDERAL 2 à bouton 37BT X 37 mm 3 clés	00003448 NS	1	-	-	-	-	-	-	-	-	-	-	-
Cylindre FEDERAL 2 à bouton 37BT X 42 mm 3 clés	00003449 NS	1	-	-	-	-	-	-	-	-	-	-	-
Cylindre FEDERAL 2 à bouton 37BT X 45 mm 3 clés	00003450 NS	1	-	-	-	-	-	-	-	-	-	-	-
Cylindre FEDERAL 2 à bouton 42BT X 42 mm 3 clés	00003459 NS	1	-	-	-	-	-	-	-	-	-	-	-
Cylindre FEDERAL 2 à bouton 42BT X 45 mm 3 clés	00003461 NS	1	-	-	-	-	-	-	-	-	-	-	-
Cylindre FEDERAL 2 à bouton 42BT X 50 mm 3 clés	00003462 NS	1	-	-	-	-	-	-	-	-	-	-	-
Cylindre FEDERAL 2 à bouton 45BT X 35 mm 3 clés	00003463 NS	1	-	-	-	-	-	-	-	-	-	-	-
Cylindre FEDERAL 2 à bouton 45BT X 45 mm 3 clés	00003464 NS	1	-	-	-	-	-	-	-	-	-	-	-
Cylindre FEDERAL 2 à bouton 45BT X 50 mm 3 clés	00003466 NS	1	-	-	-	-	-	-	-	-	-	-	-
Cylindre FEDERAL 2 à bouton 50BT X 50 mm 3 clés	00003467 NS	1	-	-	-	-	-	-	-	-	-	-	-
Cylindre FEDERAL 2 à bouton 50BT X 55 mm 3 clés	00003468 NS	1	-	-	-	-	-	-	-	-	-	-	-
Cylindre FEDERAL 2 à bouton 50BT X 60 mm 3 clés	00003469 NS	1	-	-	-	-	-	-	-	-	-	-	-



NS Non stocké/Non-stored/Productos no estocado - Sur stock Europe Zone 1 et Zone 2, nous consulter pour délai d'approvisionnement - E Epuement/Stock depletion/Agotamiento del stock

Cylindre de sûreté / HG 5 AVEC TRIANGLE

PROTECT



GARANTIE



Cylindre profilé bouton avec triangle interne

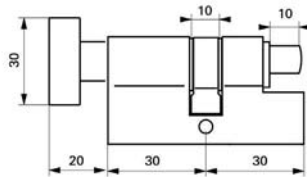

Cylindre profilé bouton avec triangle externe

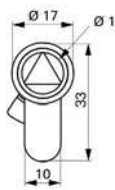
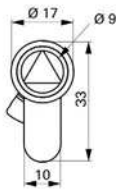
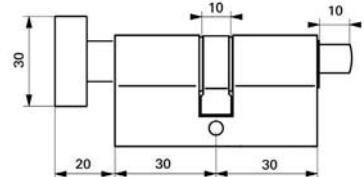

Cylindre profilé avec 2 triangles internes

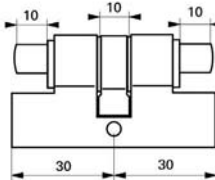

Cylindre profilé avec 2 triangles externes

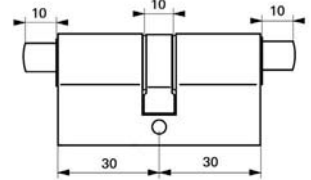

1/2 Cylindre profilé avec triangle externe

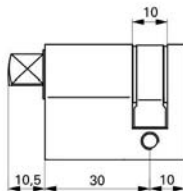

Cylindre profilé avec triangle interne

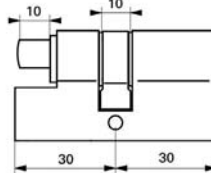

Cylindre profilé avec triangle externe

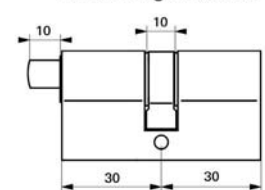

Protection Arrachement

Description/Description/Descripción

Profil européen. Mécanisme à 5 goupilles en maillechort. Panneton anti arrachement. 3 clés en acier nickelé (laiton pour organigramme).

European profile. 5 pin mechanism. Driver cam made of powdered metal. 3 nickel plated steel keys (brass for master keying system).

Perfil europeo. Mecanismo de 5 pasadores de alpaca. Pivote de acero sinterizado. 3 llaves de acero niquelado (latón en organigrama).

Finition/Finish/Acabado

Laiton ou nickelé
Brass or nickel plated
Latón o niquelado

Version/Option/Versión

Panneton orientable pour la dimension 30x10mm (autres dimensions sur demande).

With adjustable driver came for 30x10mm (other dimensions on request).

Paletón orientable para las dimensiones 30x10 mm (otras dimensiones sobre demanda).



Cylindre de sûreté / HG 5 AVEC TRIANGLE

PROTECT



Designation	Boite	Colis.	Prix	Designation	Boite	Colis.	Prix	Designation	Boite	Colis.	Prix
Cylindre profilé HG 30X10 mm laiton triangle ascenseur 9 mm	00053934	10	-	Cylindre profilé HG 35X35 mm laiton triangle externe 11 3 clés	TE11053535 NS	10	-	Cylindre profilé HG 30X60 mm laiton triangle externe 11 côté 30 3 clés	TE11053060 NS	10	-
Cylindre profilé HG 30X10 mm laiton triangle interne 11	T111053009	10	-	Cylindre profilé HG 35X35 mm laiton triangle externe 14 3 clés	TE14053535 NS	10	-	Cylindre profilé HG 30X60 mm laiton 2 triangles externes 14	2TE14053060 NS	10	-
Cylindre profilé HG 30X10 mm laiton triangle interne 14	T114053010 NS	10	-	Cylindre profilé HG 40X40 mm laiton 2 triangles externes 14	2TE14054040	10	-	Cylindre profilé HG 30X60 mm laiton triangle externe 14 côté 30 3 clés	TE14053060 NS	10	-
Cylindre profilé HG 30X10 mm laiton triangle externe 11	TE11053019	10	-	Cylindre profilé HG 45X45 mm laiton triangle externe 14 3 clés	TE14054545 NS	10	-	Cylindre profilé HG 30X70 mm laiton 2 triangles externes 14	2TE14053070 NS	10	-
Cylindre profilé HG 30X10 mm laiton triangle externe 14	TE14053017	10	-	Cylindre profilé HG 30X40 mm laiton triangle interne 11 côté 30 3 clés	T111053040 NS	10	-	Cylindre profilé HG 30X80 mm laiton triangle externe 14 côté 80 3 clés	TE14058030 NS	10	-
Cylindre profilé HG 40X10 mm laiton triangle externe 11	TE11054010 NS	10	-	Cylindre profilé HG 30X40 mm laiton triangle externe 11 côté 30 3 clés	TE11053040 NS	10	-	Cylindre profilé HG 30X100 mm laiton triangle externe 14 côté 30 3 clés	TE140530100 NS	10	-
Cylindre profilé HG 40X10 mm laiton triangle externe 14	TE14054010 NS	10	-	Cylindre profilé HG 30X40 mm laiton triangle externe 14 côté 30 3 clés	TE14053040 NS	10	-	Cylindre profilé HG 40X30 mm laiton triangle externe 14 côté 40 3 clés	TE14054030 NS	10	-
Cylindre profilé HG 60X10 mm laiton triangle externe 14	TE14056010 NS	10	-	Cylindre profilé HG 30X40 mm laiton triangle externe 14 côté 30 3 clés	TE14053040 NS	10	-	Cylindre profilé HG 45X55 mm laiton triangle externe 14 côté 45 3 clés	TE14054555 NS	10	-
Cylindre profilé HG 90X10 mm laiton triangle externe 14	TE14059010 NS	10	-	Cylindre profilé HG 30X50 mm laiton 2 triangles internes 11 laiton	2T111053050 NS	10	-	Cylindre profilé HG 30BTX30 mm laiton triangle interne 11	T111073030 NS	10	-
Cylindre profilé HG 30X30 mm laiton 2 triangles internes 11	2T111053030 NS	10	-	Cylindre profilé HG 30X50 mm laiton triangle interne 11 côté 30 3 clés	T111053050 NS	10	-	Cylindre profilé HG 30BTX30 mm laiton triangle externe 11	TE11073030	10	-
Cylindre profilé HG 30X30 mm laiton triangle interne 11 3 clés	T111053030	10	-	Cylindre profilé HG 30X50 mm laiton 2 triangles externes 11	2TE11053050 NS	10	-	Cylindre profilé HG 30BTX60 mm laiton triangle externe 11	TE11073060 NS	10	-
Cylindre profilé HG 30X30 mm laiton 2 triangles externes	2TE11053030 NS	10	-	Cylindre profilé HG 30X50 mm laiton triangle externe 11 côté 30 3 clés	TE11053050 NS	10	-	Cylindre profilé HG 40BTX30 mm laiton triangle externe 14 côté 30	TE14074030 NS	10	-
Cylindre profilé HG 30X30 mm laiton triangle externe 11 3 clés	TE11053030	10	-	Cylindre profilé HG 30X50 mm laiton triangle externe 14 côté 30 3 clés	TE14053050 NS	10	-	Cylindre profilé HG 45BTX45 mm laiton triangle externe 14	TE14074545 NS	10	-
Cylindre profilé HG 30X30 mm laiton triangle interne 14 3 clés	T114053030 NS	10	-	Cylindre profilé HG 30X50 mm laiton triangle externe 14 côté 50 3 clés	TE14055030 NS	10	-	Cylindre profilé HG 60BTX30 mm laiton triangle externe 11	TE11076030 NS	10	-
Cylindre profilé HG 30X30 mm laiton 2 triangles externes 14	2TE14053030	10	-	Cylindre profilé HG 30X60 mm laiton triangle interne 11 côté 30 3 clés	T111053060 NS	10	-	Cylindre profilé HG 30X10 mm nickelé triangle ascenseur 9 mm	00053935 NS	10	-
Cylindre profilé HG 35X35 mm laiton triangle interne 11 3 clés	T111053535 NS	10	-					Cylindre profilé HG 30X10 mm nickelé triangle interne 11	T111053011 NS	10	-



NS Non stocké/Non-stored/Productos no estocado - Sur stock Europe Zone 1 et Zone 2, nous consulter pour délai d'approvisionnement - E Epuement/Stock depletion/Agotamiento del stock

Cylindre de sûreté / HG 5 AVEC TRIANGLE

PROTECT



Designation	Boite	Colis.	Prix	Designation	Boite	Colis.	Prix	Designation	Boite	Colis.	Prix
Cylindre profilé HG 30X10 mm nickelé triangle externe 11	TE11053011 NS	10	-	Cylindre profilé HG 40X40 mm nickelé triangle interne 11	TI11054041 NS	10	-	Cylindre profilé HG 30X60 mm nickelé triangle externe 11 côté 30 3 clés	TE11053961 NS	10	-
Cylindre profilé HG 30X10 mm nickelé triangle externe 14	TE14053011 NS	10	-	Cylindre profilé HG 40X40 mm nickelé triangle externe 11	TE11054041 NS	10	-	Cylindre profilé HG 30X60 mm nickelé 2 triangles externes 14	2TE14053061 NS	10	-
Cylindre profilé HG 40X10 mm nickelé triangle externe 14	TE14054011 NS	10	-	Cylindre profilé HG 40X40 mm nickelé triangle externe 14	TE14054041	10	-	Cylindre profilé HG 30X60 mm nickelé triangle externe 14 côté 30 3 clés	TE14053962 NS	10	-
Cylindre profilé HG 30X30 mm nickelé 2 triangles internes 11	2TI11053031 NS	10	-	Cylindre profilé HG 40X40 mm nickelé triangle externe 14	TE14054041	10	-	Cylindre profilé HG 30X60 mm nickelé triangle externe 14 côté 30 3 clés	TE14056031 NS	10	-
Cylindre profilé HG 30X30 mm nickelé triangle interne 11	TI11053031	10	-	Cylindre profilé HG 30X40 mm nickelé triangle interne 11 côté 30 3 clés	TI11053041 NS	10	-	Cylindre profilé HG 30X60 mm nickelé triangle externe 14 côté 60 3 clés	TE14054031 NS	10	-
Cylindre profilé HG 30X30 mm nickelé 2 triangles externes 11	2TE11053031 NS	10	-	Cylindre profilé HG 30X40 mm nickelé triangle externe 11 côté 30 3 clés	TE11053041 NS	10	-	Cylindre profilé HG 40X30 mm nickelé triangle externe 14 côté 40 3 clés	TI11073031 NS	10	-
Cylindre profilé HG 30X30 mm nickelé triangle externe 11	TE11053931	10	-	Cylindre profilé HG 30X40 mm nickelé triangle externe 14 côté 30 3 clés	TE14053041 NS	10	-	Cylindre profilé HG 30BTX30 mm nickelé triangle interne 11	TE14073031 NS	10	-
Cylindre profilé HG 30X30 mm nickelé triangle externe 14	TE14053932	10	-	Cylindre profilé HG 30X50 mm nickelé triangle interne 11 côté 30 3 clés	TI11053051 NS	10	-	Cylindre profilé HG 30BTX30 mm nickelé triangle externe 14	TE14073536 NS	10	-
Cylindre profilé HG 30X30 mm nickelé 2 triangles externes 14	2TE14053031	10	-	Cylindre profilé HG 30X50 mm nickelé triangle externe 11 nickelé	2TE11053051 NS	10	-	Cylindre profilé HG 35BTX35 mm nickelé triangle externe 14	TE11074041 NS	10	-
Cylindre profilé HG 35X35 mm nickelé triangle interne 11	TI11053536 NS	10	-	Cylindre profilé HG 30X50 mm nickelé triangle externe 11 côté 30 3 clés	TE11053051 NS	10	-	Cylindre profilé HG 40BTX40 mm nickelé triangle externe 11	TE14073041 NS	10	-
Cylindre profilé HG 35X35 mm nickelé triangle externe 11	TE11053536 NS	10	-	Cylindre profilé HG 30X50 mm nickelé triangle externe 14 côté 30 3 clés	TE14053051 NS	10	-	Cylindre profilé HG 30BTX40 mm nickelé triangle externe 14	TE14074031 NS	10	-
Cylindre profilé HG 35X35 mm nickelé triangle externe 14	TE14053536 NS	10	-	Cylindre profilé HG 30X60 mm nickelé triangle interne 11 côté 30 3 clés	TI11053061 NS	10	-	Clé triangle 9 mm	00013923	10	-
Cylindre profilé HG 40X40 mm nickelé 2 triangles internes 11	2TI11054041 NS	10	-					Clé triangle 11 mm	00013924	10	-
								Clé triangle 14 mm	00013925	10	-

Cylindre de sûreté / HG 5 AVEC CARRÉ

PROTECT



GARANTIE



Cylindre profilé bouton avec triangle interne

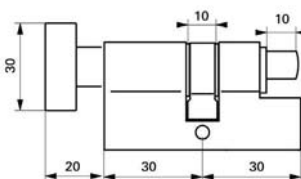

Cylindre profilé bouton avec triangle externe

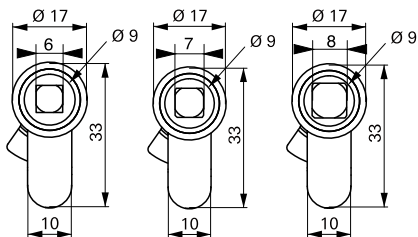
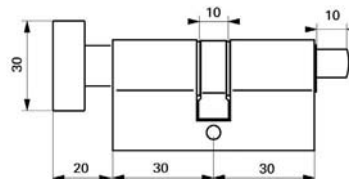

Cylindre profilé avec 2 triangles internes

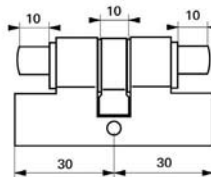

Cylindre profilé avec 2 triangles externes

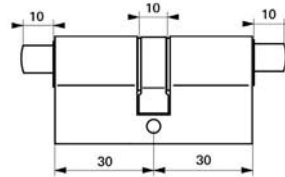

1/2 Cylindre profilé avec triangle externe

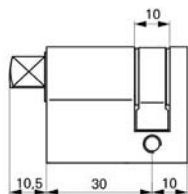

Cylindre profilé avec triangle interne

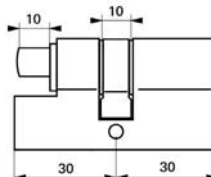

Cylindre profilé avec triangle externe

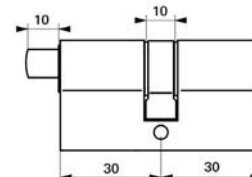

Protection Arrachement

Description/Description/Descripción

Profil européen. Mécanisme à 5 goupilles en maillechort. Panneton anti arrachement. 3 clés en acier nickelé (laiton pour organigramme).

European profile. 5 pin mechanism. Driver cam made of powdered metal. 3 nickel plated steel keys (brass for master keying system).

Perfil europeo. Mecanismo de 5 pasadores de alpaca. Pivote de acero sinterizado. 3 llaves de acero niquelado (latón en organigrama).

Finition/Finish/Acabado

Laiton ou nickelé

Brass or nickel plated

Latón o niquelado

Version/Option/Versión

Panneton orientable pour la dimension 30x10mm (autres dimensions sur demande). Carré de 6/7/8mm, interne, externe.

With adjustable driver came for 30x10mm (other dimensions on request). Square 6/7/8mm, internal, external.

Paletón orientable para las dimensiones 30x10 mm (otras dimensiones sobre demanda). Cuadrado de 6/7/8mm, interior, exterior.



913825

Designation	Boite	Colis.	Prix	Designation	Boite	Colis.	Prix	Designation	Boite	Colis.	Prix
Cylindre profilé HG bouton + carré extérieur 7mm 40x40 nickelé	CE774041 NS	10	-	Cylindre profilé HG clé + carré intérieur 6mm 40x40 nickelé	CI654041 NS	10	-	Cylindre profilé HG bouton + carré intérieur 7mm 30x50 nickelé	CI773051 NS	10	-
Cylindre profilé HG carré extérieur 8mm 30x10 laiton	CE853010 NS	10	-	Cylindre profilé HG carré intérieur 6mm 50x10 laiton	CI655010 NS	10	-	Cylindre profilé HG bouton + carré intérieur 7mm 30x60 laiton	CI773060 NS	10	-
Cylindre profilé HG carré extérieur 8mm 30x10 nickelé	CE853011 NS	10	-	Cylindre profilé HG carré intérieur 6mm 50x10 nickelé	CI655011 NS	10	-	Cylindre profilé HG bouton + carré intérieur 7mm 30x60 nickelé	CI773061 NS	10	-
Cylindre profilé HG clé + carré extérieur 8mm 30x30 laiton	CE853030 NS	10	-	Cylindre profilé HG bouton + carré intérieur 6mm 30x30 laiton	CI673030 NS	10	-	Cylindre profilé HG bouton + carré intérieur 7mm 40x40 nickelé	CI774040 NS	10	-
Cylindre profilé HG clé + carré extérieur 8mm 30x30 nickelé	CE853031 NS	10	-	Cylindre profilé HG bouton + carré intérieur 6mm 30x30 nickelé	CI673031 NS	10	-	Cylindre profilé HG bouton + carré intérieur 7mm 40x40 laiton	CI774041 NS	10	-
Cylindre profilé HG clé + carré extérieur 8mm 30x40 laiton	CE853040 NS	10	-	Cylindre profilé HG bouton + carré intérieur 6mm 30x40 laiton	CI673040 NS	10	-	Cylindre profilé HG carré intérieur 8mm 30x10 laiton	CI853010 NS	10	-
Cylindre profilé HG clé + carré extérieur 8mm 30x40 nickelé	CE853041 NS	10	-	Cylindre profilé HG bouton + carré intérieur 6mm 30x40 nickelé	CI673041 NS	10	-	Cylindre profilé HG carré intérieur 8mm 30x10 nickelé	CI853011 NS	10	-
Cylindre profilé HG carré extérieur 8mm 40x10 laiton	CE854010 NS	10	-	Cylindre profilé HG bouton + carré intérieur 6mm 30x50 laiton	CI673050 NS	10	-	Cylindre profilé HG clé + carré intérieur 8mm 30x30 laiton	CI853030 NS	10	-
Cylindre profilé HG carré extérieur 8mm 40x10 nickelé	CE854011 NS	10	-	Cylindre profilé HG bouton + carré intérieur 6mm 30x50 nickelé	CI673051 NS	10	-	Cylindre profilé HG clé + carré intérieur 8mm 30x30 nickelé	CI853031 NS	10	-
Cylindre profilé HG clé + carré extérieur 8mm 40x40 laiton	CE854040 NS	10	-	Cylindre profilé HG bouton + carré intérieur 6mm 30x60 laiton	CI673060 NS	10	-	Cylindre profilé HG clé + carré intérieur 8mm 30x40 laiton	CI853040 NS	10	-
Cylindre profilé HG clé + carré extérieur 8mm 40x40 nickelé	CE854041 NS	10	-	Cylindre profilé HG bouton + carré intérieur 6mm 30x60 nickelé	CI673061 NS	10	-	Cylindre profilé HG clé + carré intérieur 8mm 30x40 nickelé	CI853041 NS	10	-
Cylindre profilé HG carré extérieur 8mm 50x10 laiton	CE855010 NS	10	-	Cylindre profilé HG bouton + carré intérieur 6mm 30x60 nickelé	CI674040 NS	10	-	Cylindre profilé HG carré intérieur 8mm 40x10 laiton	CI854010 NS	10	-
Cylindre profilé HG carré extérieur 8mm 50x10 nickelé	CE855011 NS	10	-	Cylindre profilé HG bouton + carré intérieur 6mm 40x40 laiton	CI674041 NS	10	-	Cylindre profilé HG carré intérieur 8mm 40x10 nickelé	CI854011 NS	10	-
Cylindre profilé HG bouton + carré extérieur 8mm 30x30 laiton	CE873030 NS	10	-	Cylindre profilé HG bouton + carré intérieur 6mm 40x40 nickelé	CI674041 NS	10	-	Cylindre profilé HG clé + carré intérieur 8mm 40x40 laiton	CI854040 NS	10	-
Cylindre profilé HG bouton + carré extérieur 8mm 30x30 nickelé	CE873031 NS	10	-	Cylindre profilé HG bouton + carré intérieur 6mm 40x40 nickelé	CI753010 NS	10	-	Cylindre profilé HG clé + carré intérieur 8mm 40x40 nickelé	CI854041 NS	10	-
Cylindre profilé HG bouton + carré extérieur 8mm 30x40 laiton	CE873040 NS	10	-	Cylindre profilé HG carré intérieur 7mm 30x10 laiton	CI753011 NS	10	-	Cylindre profilé HG carré intérieur 8mm 50x10 laiton	CI855010 NS	10	-
Cylindre profilé HG bouton + carré extérieur 8mm 30x40 nickelé	CE873041 NS	10	-	Cylindre profilé HG carré intérieur 7mm 30x10 nickelé	CI753011 NS	10	-	Cylindre profilé HG carré intérieur 8mm 50x10 nickelé	CI855011 NS	10	-
Cylindre profilé HG bouton + carré extérieur 8mm 30x50 laiton	CE873050 NS	10	-	Cylindre profilé HG clé + carré intérieur 7mm 30x30 laiton	CI753030 NS	10	-	Cylindre profilé HG bouton + carré intérieur 8mm 30x30 laiton	CI873030 NS	10	-
Cylindre profilé HG bouton + carré extérieur 8mm 30x50 nickelé	CE873051 NS	10	-	Cylindre profilé HG clé + carré intérieur 7mm 30x30 nickelé	CI753031 NS	10	-	Cylindre profilé HG bouton + carré intérieur 8mm 30x30 nickelé	CI873031 NS	10	-
Cylindre profilé HG bouton + carré extérieur 8mm 30x60 laiton	CE873060 NS	10	-	Cylindre profilé HG clé + carré intérieur 7mm 30x40 laiton	CI753040 NS	10	-	Cylindre profilé HG bouton + carré intérieur 8mm 30x40 nickelé	CI873040 NS	10	-
Cylindre profilé HG bouton + carré extérieur 8mm 30x60 nickelé	CE873061 NS	10	-	Cylindre profilé HG clé + carré intérieur 7mm 30x40 nickelé	CI753041 NS	10	-	Cylindre profilé HG bouton + carré intérieur 8mm 30x40 laiton	CI873040 NS	10	-
Cylindre profilé HG bouton + carré extérieur 8mm 40x40 laiton	CE874040 NS	10	-	Cylindre profilé HG carré intérieur 7mm 40x10 laiton	CI754010 NS	10	-	Cylindre profilé HG bouton + carré intérieur 8mm 30x50 laiton	CI873050 NS	10	-
Cylindre profilé HG bouton + carré extérieur 8mm 40x40 nickelé	CE874041 NS	10	-	Cylindre profilé HG carré intérieur 7mm 40x10 nickelé	CI754011 NS	10	-	Cylindre profilé HG bouton + carré intérieur 8mm 30x50 nickelé	CI873051 NS	10	-
Cylindre profilé HG carré intérieur 6mm 30x10 laiton	CI653010 NS	10	-	Cylindre profilé HG carré intérieur 7mm 40x10 nickelé	CI754040 NS	10	-	Cylindre profilé HG bouton + carré intérieur 8mm 30x60 nickelé	CI873060 NS	10	-
Cylindre profilé HG carré intérieur 6mm 30x10 nickelé	CI653011 NS	10	-	Cylindre profilé HG clé + carré intérieur 7mm 40x40 laiton	CI754041 NS	10	-	Cylindre profilé HG bouton + carré intérieur 8mm 30x60 laiton	CI873061 NS	10	-
Cylindre profilé HG clé + carré intérieur 6mm 30x30 laiton	CI653030 NS	10	-	Cylindre profilé HG clé + carré intérieur 7mm 40x40 nickelé	CI755010 NS	10	-	Cylindre profilé HG bouton + carré intérieur 8mm 30x60 nickelé	CI873061 NS	10	-
Cylindre profilé HG clé + carré intérieur 6mm 30x30 nickelé	CI653031 NS	10	-	Cylindre profilé HG bouton + carré intérieur 7mm 30x30 nickelé	CI773030 NS	10	-	Cylindre profilé HG bouton + carré intérieur 8mm 40x40 laiton	CI874040 NS	10	-
Cylindre profilé HG clé + carré intérieur 6mm 30x40 laiton	CI653040 NS	10	-	Cylindre profilé HG bouton + carré intérieur 7mm 30x30 nickelé	CI773031 NS	10	-	Cylindre profilé HG bouton + carré intérieur 8mm 40x40 nickelé	CI874041 NS	10	-
Cylindre profilé HG clé + carré intérieur 6mm 30x40 nickelé	CI653041 NS	10	-	Cylindre profilé HG bouton + carré intérieur 7mm 30x40 laitonZ	CI773040 NS	10	-	Cylindre profilé HG bouton + carré intérieur 8mm 40x40 nickelé	913823	10	-
Cylindre profilé HG carré intérieur 6mm 40x10 laiton	CI654010 NS	10	-	Cylindre profilé HG bouton + carré intérieur 7mm 30x40 nickelé	CI773041 NS	10	-	Clé femelle pour cylindre empreinte carré sortant 6 mm	913824	10	-
Cylindre profilé HG carré intérieur 6mm 40x10 nickelé	CI654011 NS	10	-	Cylindre profilé HG bouton + carré intérieur 7mm 30x50 laiton	CI773050 NS	10	-	Clé femelle pour cylindre empreinte carré sortant 7 mm	913825	10	-
Cylindre profilé HG clé + carré intérieur 6mm 40x40 laiton	CI654040 NS	10	-					Clé femelle pour cylindre empreinte carré sortant 8 mm			

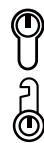

NS Non stocké/Non-stored/Producto no estocado - Sur stock Europe Zone 1 et Zone 2, nous consulter pour délai d'approvisionnement - E Epuisement/Stock depletion/Agotamiento del stock

Cylindre de sûreté / OVALE ECO

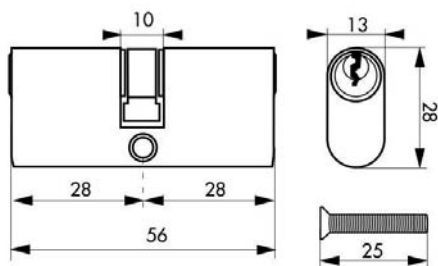

GARANTIE



X 3

Description/Description/Descripción

Cylindre laiton à profil ovale. Mécanisme à 5 goupilles. Panneton anti-arrachement. 3 clés.

Brass profile. 5 pins mechanism. Driver came made of powdered metal. 3 keys.

Perfil de latón. Mecanismo con 5 pasadores. Pivote de acero sinterizado. 3 llaves.

Finition/Finish/Acabado

Laiton ou nickelé

Brass or nickel plated

Latón o niquelado

Designation	Boite	Colis.	Prix	Sachet	Colis.	Prix	Brochable					Colis.	Prix
							France	Euro 1	Euro 2	Euro 3	Euro 4		
Cylindre Ovale 28 x 28 mm laiton 3 clés	00016311	10	-	-	-	-	-	-	-	00194081	-	10	-
Cylindre Ovale 28 x 35 mm laiton 3 clés	00016329	10	-	-	-	-	-	-	-	00194209	-	10	-
Cylindre Ovale 30 x 30 mm nickelé 3 clés	00016320	10	-	-	-	-	-	-	-	00194210	-	10	-

Cylindre / RIM ECO

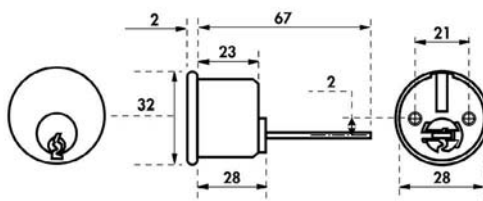

GARANTIE



X 3

Description/Description/Descripción

Mécanisme à 5 goupilles. 3 clés en acier nickelé.

5 pin mechanism. 3 nickel plated steel keys.

Mecanismo con 5 pasadores. 3 llaves de acero niquelado.

Utilisation/Use/Utilización

Serrure de porte d'entrée.

Rim lock or mortice lock for entrance door.

Cerradura de puerta de entrada para aplicar o para empotrar.

Finition/Finish/Acabado

Laiton

Brass

Latón

Designation	Boite	Colis.	Prix	Sachet	Colis.	Prix	Brochable					Colis.	Prix
							France	Euro 1	Euro 2	Euro 3	Euro 4		
Cylindre RIM 3 clés	-	-	-	-	-	-	-	00193247 NS	00192247 NS	-	-	10	-

Cylindre / RIM PROTECT

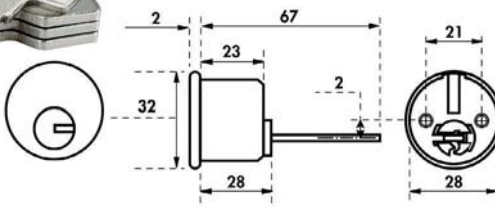

GARANTIE



X 4

Description/Description/Descripción

Mécanisme à 6 goupilles. 4 clés plates réversibles en acier nickelé.
6 pin mechanism. 4 reversible nickel plated steel keys.
Mecanismo con 6 pasadores. 4 llaves planas reversibles de acero niquelado.

Finition/Finish/Acabado

Laiton/ Brass/ Latón

Utilisation/Use/Utilización

Serrure de porte d'entrée.
Rim lock or mortice lock for entrance door.
Cerradura de puerta de entrada para aplicar o para empotrar.

Designation	Boîte	Colis.	Prix	Sachet	Colis.	Prix	Brochable					Colis.	Prix
							France	Euro 1	Euro 2	Euro 3	Euro 4		
Cylindre RIM 4 clés réversibles	-	-	-	-	-	-	-	00193434 NSI	00192434 NSI	-	-	10	-

Cylindre de haute sûreté / ADRIATIC À LANGUETTE RESIST

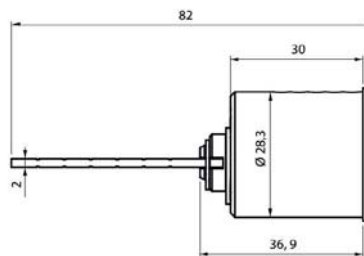
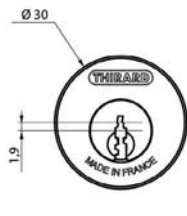

GARANTIE



X 4

Description/Description/Descripción

Corps laiton. Mécanisme de 6 à 22 goupilles maillechort sur 5 rangées. Protection contre le perçage par 1ère goupille + poussoir en acier trempé. 4 clés plates maillechort avec carte de propriété permettant la reproduction des clés exclusivement en usine. Pièce mobile anti-crochetage interne au cylindre interdisant toute reproduction hors usine.

Nickel silver mechanism with 6 to 22 pins over 5 rows.
Tempered steel anti-drilling protection to first key pin and driver pin. 4 flat nickel silver keys with ownership card for factory-only duplication. Anti-picking pin internal to the cylinder preventing any non-factory duplication.

Cuerpos de latón. Mecanismo de 6 a 22 pasadores de alpaca en 5 hileras. Protección anti-perforación mediante primer pasador + aguja de acero templado. 4 llaves planas de alpaca con tarjeta de propiedad para su reproducción únicamente en fábrica. Piiza móvil anti-forzamiento dentro del cilindro que impide su reproducción fuera de la fábrica.

Finition/Finish/Acabado

Nickelé / Nickel plated / Niquelado

Versión/Option/Versión

Possibilité d'identification de la clé par bille de couleur.
Coloured dot key identification system.
Posibilidad de identificación de la llave con bola de color.

Designation	Boîte	Colis.	Prix	Sachet	Colis.	Prix	Brochable					Colis.	Prix
							France	Euro 1	Euro 2	Euro 3	Euro 4		
Cylindre rond ADRIATIC à languette 4 clés	00030405 NSI	1	-	-	-	-	-	-	-	-	-	-	-

NS Non stocké/Non-stored/Producto no estocado - S Sur stock Europe Zone 1 et Zone 2, nous consulter pour délai d'approvisionnement - E Epuisement/Stock depletion/Agotamiento del stock

Cylindre de haute sûreté / COBRA M RESIST

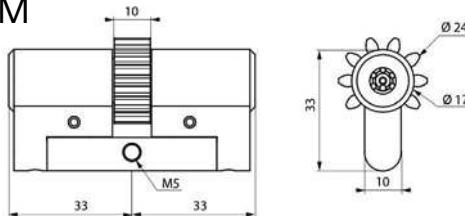

GARANTIE



X 3

Description/Description/Descripción

Profil européen laiton. Mécanisme à 5 pompes de sécurité axiales équipées de faux-crans contre le crochetaje et 1 pompe radiale. Protection contre la casse par poutre en acier. Pignon d'entraînement 10 dents. 3 clés ergonomiques brevetées avec carte de propriété pour la reproduction exclusive en usine.

Brass Europrofile. 5 axial pin security mechanism with anti-picking false gates and 1 radial pin. Steel anti-snapping bar 10-tooth drive pinion. 3 patented ergonomic keys with ownership card for factory-only duplication.

Perfil europeo de latón. Mecanismo de 5 bombas de seguridad axiales equipadas con muescas falsas anti-forzamiento y 1 bomba radial. Protección anti-rotura con viga de acero. Piñón de arrastre de 10 dientes. 3 llaves ergonómicas patentadas con tarjeta de propiedad para su reproducción únicamente en fábrica.

Finition/Finish/Acabado

Nickelé / Nickel plated / Niquelado

Version/Option/Versión

Clé avec insert plus long de 8 mm. Possibilité d'identification de la clé par capot de couleur (noir, vert, jaune, rouge, blanc, orange). Autres dimensions sur demande.

Key with 8 mm longer blade. Head available in different colours (black, green, yellow, red, white, orange) for easy identification. Other sizes available to order.

Llave de punta larga de 8 mm. Posibilidad de identificación de la llave con cubierta de color (negro, verde, amarillo, rojo, blanco, naranja). Otros tamaños por encargo.

Designation	Boite	Colis.	Prix	Sachet	Colis.	Prix	Brochable					Colis.	Prix
							France	Euro 1	Euro 2	Euro 3	Euro 4		
Cylindre profilé COBRA M 33 x 33mm panneton 10 dents 3 clés	00030118 NS	1	-	-	-	-	-	-	-	-	-	-	-

Cylindre de haute sûreté / ADAPTATEUR LAP RESIST

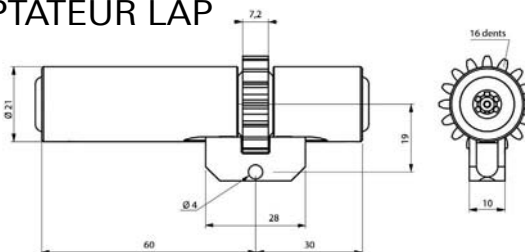

GARANTIE



X 3

Description/Description/Descripción

Corps laiton. Mécanisme à 5 pompes de sécurité axiales équipées de faux-crans contre le crochetaje et 1 pompe radiale. Protection contre la casse par poutre en acier. Pignon d'entraînement 16 dents. 3 clés ergonomiques brevetées avec carte de propriété pour la reproduction exclusive en usine.

Brass body. 5 axial pin security mechanism with anti-picking false gates and 1 radial pin. Steel anti-snapping bar 16-tooth drive pinion. 3 patented ergonomic keys with ownership card for factory-only duplication.

Cuerpos de latón. Mecanismo de 5 bombas de seguridad axiales equipadas con muescas falsas anti-forzamiento y 1 bomba radial. Protección anti-rotura con viga de acero. Piñón de arrastre de 16 dientes. 3 llaves ergonómicas patentadas con tarjeta de propiedad para su reproducción únicamente en fábrica.

Finition/Finish/Acabado

Nickelé / Nickel plated / Niquelado

Version/Option/Versión

Clé avec insert plus long de 8 mm. Possibilité d'identification de la clé par capot de couleur (noir, vert, jaune, rouge, blanc, orange).

Key with 8 mm longer blade. Head available in different colours (black, green, yellow, red, white, orange) for easy identification.

Llave de punta larga de 8 mm. Posibilidad de identificación de la llave con cubierta de color (negro, verde, amarillo, rojo, blanco, naranja).

Use/Utilización

Serrure de porte d'entrée. / Rim lock or mortice lock for entrance door. / Cerradura de puerta de entrada para aplicar o para empotrar.

Designation	Boite	Colis.	Prix	Sachet	Colis.	Prix	Brochable					Colis.	Prix
							France	Euro 1	Euro 2	Euro 3	Euro 4		
Cylindre adaptateur COBRA LAP 30 x 60mm Ø 21mm panneton cranté 3 clés	00030115 NS	1	-	-	-	-	-	-	-	-	-	-	-
Cylindre adaptateur COBRA LAP 35 x 60mm Ø 21mm panneton cranté 3 clés	00030117 NS	1	-	-	-	-	-	-	-	-	-	-	-

Cylindre de haute sûreté / ADAPTEUR LAP CYLINDRE DOUBLE RESIST

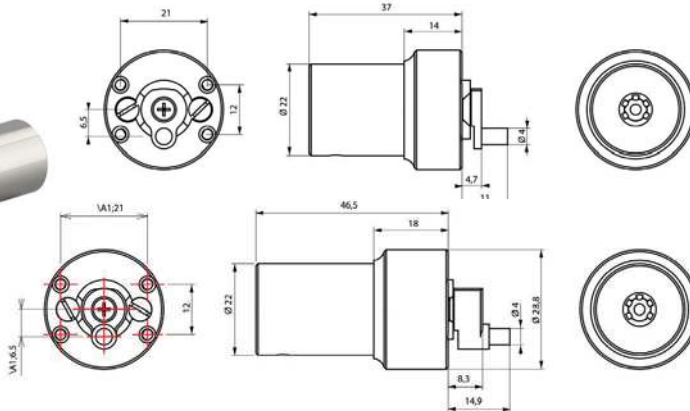

GARANTIE



X 3

Description/Description/Descripción

Corps laiton. Mécanisme à 5 pompes de sécurité axiales équipées de faux-crans contre le crochetage et 1 pompe radiale. 3 clés ergonomiques insert long (+8 mm) brevetées avec carte de propriété pour la reproduction exclusive en usine.

Brass body. 5 axial pin security mechanism with anti-picking false gates and 1 radial pin. 3 patented ergonomic keys with 8 mm longer blade with ownership card limiting duplication exclusively to the factory.

Cuerpos de latón. Mecanismo de 5 bombas de seguridad axiales equipadas con muescas falsas anti-forzamiento y 1 bomba radial. 3 llaves ergonómicas de punta larga

(+8 mm). patentadas con tarjeta de propiedad para su reproducción únicamente en fábrica.

Finition/Finish/Acabado

Nickelé / Nickel plated / Niquelado

Versión/Option/Versión

Possibilité d'identification de la clé par capot de couleur (noir, vert, jaune, rouge, blanc, orange).

Head available in different colours (black, green, yellow, red, white, orange) for easy identification.

Posibilidad de identificación de la llave con cubierta de color (negro, verde, amarillo, rojo, blanco, naranja).

Designation	Boite	Colis.	Prix	Sachet	Colis.	Prix	Brochable					Colis.	Prix
							France	Euro 1	Euro 2	Euro 3	Euro 4		
Cylindre adaptateur rond COBRA LAP double cylindre 37 x 46mm Ø 22mm 3 clés	00030114 NS	1	-	-	-	-	-	-	-	-	-	-	-

Cylindre de haute sûreté / PLX RESIST

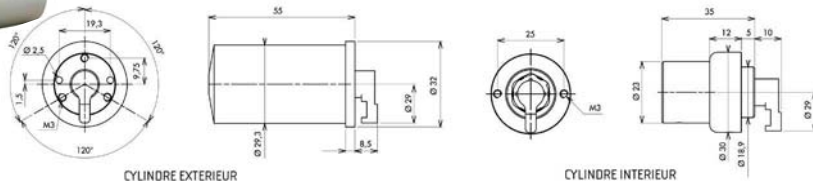

GARANTIE



X 3

Description/Description/Descripción

Corps laiton. Mécanisme à 5 pompes de sécurité axiales équipées de faux crans contre le crochetage et 1 pompe radiale. 3 clés ergonomiques avec insert plus long de 8 mm brevetées, avec carte de propriété pour reproduction exclusive en usine. Cabochon de protection cylindre extérieur. Possibilité d'identification de la clé par capot couleur.

Brass body. 5 axial pin security mechanism with anti-picking false gates and 1 radial pin. 3 patented ergonomic keys with 8 mm longer blade, with ownership card for factory-only duplication. External cylinder guard. Head available in different colours.

Cuerpo de latón. Mecanismo de 5 bombas de seguridad

axiales equipadas con muescas falsas anti-forzamiento y 1 bomba radial. 3 llaves ergonómicas patentadas de punta larga de 8 mm, con tarjeta de propiedad para su reproducción únicamente en fábrica. Cabujón de protección del cilindro exterior. Posibilidad de identificación de la llave con cubierta de color.

Finition/Finish/Acabado

Laiton / Brass / Latón

Utilisation/Use/Utilización

Pour adaptation serrure applique / For rim lock adaptation
Para la adaptación de cerradura sobreponer

Designation	Boite	Colis.	Prix	Sachet	Colis.	Prix	Brochable					Colis.	Prix
							France	Euro 1	Euro 2	Euro 3	Euro 4		
Cylindre adaptateur rond COBRA PLX double cylindre 35 x 55mm Ø 23mm 3 clés	00030139 NS	1	-	-	-	-	-	-	-	-	-	-	-

Cylindre de haute sûreté / COBRA M À LANGUETTE - SUJ RESIST

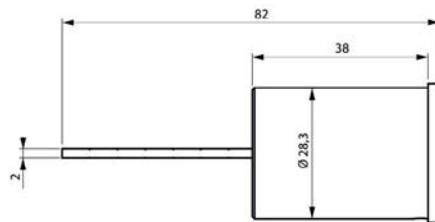
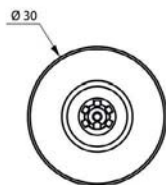

GARANTIE



X 3

Description/Description/Descripción

Corps laiton. Mécanisme à 5 pompes de sécurité axiales équipées de faux-crans contre le crochetage et 1 pompe radiale. 3 clés ergonomiques brevetées avec carte de propriété pour la reproduction exclusive en usine.

Brass body. 5 axial pin security mechanism with anti-picking false gates and 1 radial pin. 3 patented ergonomic keys with ownership card for factory-only duplication.

Cuerpos de latón. Mecanismo de 5 bombas de seguridad axiales equipadas con muescas falsas anti-forzamiento y 1 bomba radial. 3 llaves ergonómicas patentadas con tarjeta de propiedad para su reproducción únicamente en fábrica.

Finition/Finish/Acabado

Nickelé / Nickel plated / Niquelado

Version/Option/Versión

Possibilité d'identification de la clé par capot de couleur (noir, vert, jaune, rouge, blanc, orange).

Head available in different colours (black, green, yellow, red, white, orange) for easy identification.

Posibilidad de identificación de la llave con cubierta de color (negro, verde, amarillo, rojo, blanco, naranja).

Designation	Boite	Colis.	Prix	Sachet	Colis.	Prix	Brochable				Colis.	Prix
							France	Euro 1	Euro 2	Euro 3		
Cylindre rond COBRA M Ø 30mm à languette - SUJ - 3 clés	00030401 NS	1	-	-	-	-	-	-	-	-	-	-

Cylindre de haute sûreté / ADAPTATEUR CIS RESIST

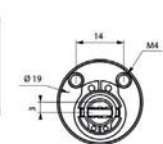
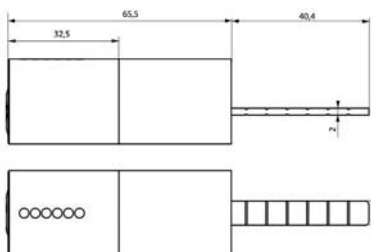
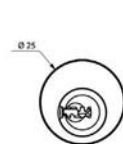
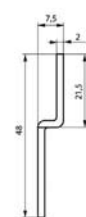
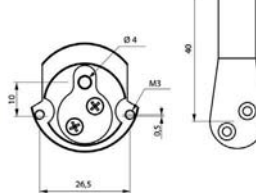
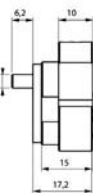
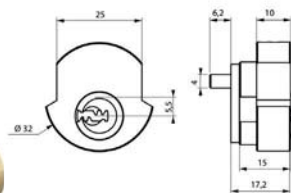
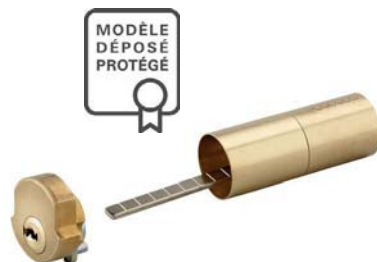

GARANTIE



X 4

Description/Description/Descripción

Corps laiton. Mécanisme à 8 goupilles maillechort. 4 clés plates réversibles laiton nickelé avec carte de propriété. *Brass body. 8 nickel silver key pins. 4 nickel-plated brass reversible flat keys with ownership card.*

Cuerpos de latón. Mecanismo de 8 pasadores de alpaca. 4 llaves planas reversibles de latón niquelado con tarjeta de propiedad.

Version/Option/Versión

Possibilité d'identification de la clé par capot de couleur (noir, vert, jaune, rouge, blanc, orange).

Head available in different colours (black, green, yellow, red, white, orange) for easy identification.

Posibilidad de identificación de la llave con cubierta de color (negro, verde, amarillo, rojo, blanco, naranja).

Finition/Finish/Acabado

Laiton / Brass / Latón

Designation	Boite	Colis.	Prix	Sachet	Colis.	Prix	Brochable				Colis.	Prix
							France	Euro 1	Euro 2	Euro 3		
Cylindre adaptateur rond T2 CIS 10 x 65mm Ø 25mm 4 clés réversibles	00030113 NS	1	-	-	-	-	-	-	-	-	-	-

Cylindre de haute sûreté / ADAPTATEUR FIC RESIST



GARANTIE



X 4

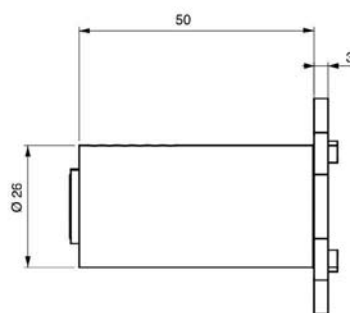
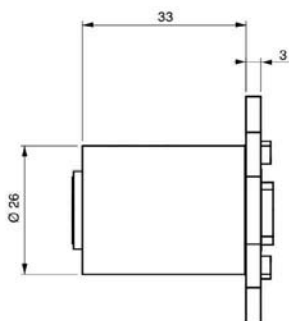
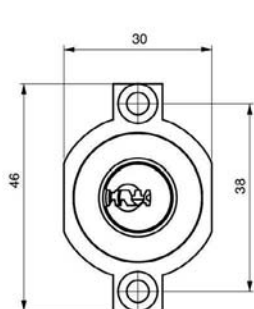

Description/Description/Descripción

Corps laiton. Mécanisme à 8 goupilles maillechort. 4 clés plates réversibles laiton nickelé avec carte de propriété.

Brass body. 8 nickel silver key pins. 4 nickel-plated brass reversible flat keys with ownership card.

Cuerpos de latón. Mecanismo de 8 pasadores de alpaca. 4 llaves planas reversibles de latón niquelado con tarjeta de propiedad.

Finition/Finish/Acabado

Laiton

Brass

Latón

Version/Option/Versión

Protection contre le perçage par 1ère goupille + poussoir en acier trempé.

Tempered steel anti-drilling protection to first key pin and driver pin.

Protección anti-perforación mediante primer pasador + aguja de acero templado.

Designation	Boite	Colis.	Prix	Sachet	Colis.	Prix	Brochable					Colis.	Prix
							France	Euro 1	Euro 2	Euro 3	Euro 4		
Cylindre adaptateur rond T2 FIC 33 x 50mm Ø 26mm 4 clés réversibles	00030111 NS	1	-	-	-	-	-	-	-	-	-	-	-

NS Non stocké/Non-stored/Producto no estocado - Sur stock Europe Zone 1 et Zone 2, nous consulter pour délai d'approvisionnement - E Epuisement/Stock depletion/Agotamiento del stock

Cylindre de haute sûreté / BLCT

RESIST

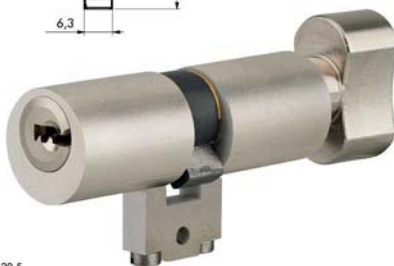
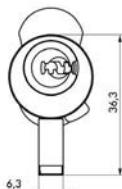
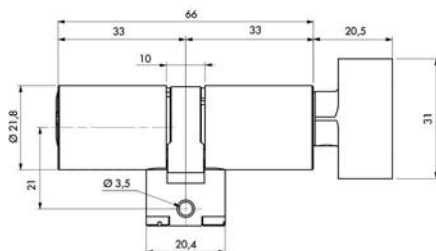
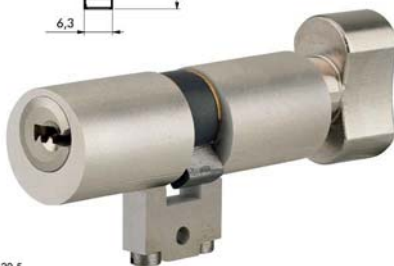
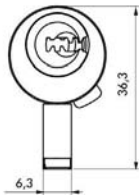
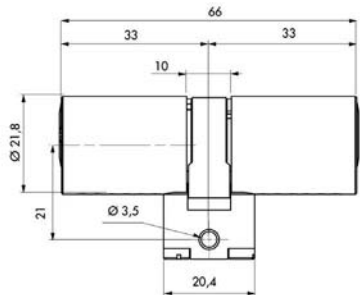

GARANTIE



X 4

Description/Description/Descripción

Mécanisme à 8 goupilles (7 en maillechort et 1ère en acier trempé). Protection contre le perçage par 1ère goupille + poussoir en acier trempé. Protection contre la casse par poutre en acier. 4 clés plates réversibles en laiton nickelé avec carte de propriété.

8 pin mechanism (7 nickel silver and first hardened steel pin). Protection against drilling by hardened steel pins. Protection against breaking by steel bar. 4 reversible brass nickel keys with a personal security card.

Mecanismo de 8 bombas (7 de alpaca y un pasador de acero templado). Protección contra el taladrado por un pasador de acero templado. Protección contra la rotura mediante una viga de acero. 4 llaves planas de latón niquelado reversibles patentadas con título de propiedad.

Finition/Finish/Acabado

Nickel mat

Matt nickel

Níquel mate

Version/Option/Versión

Cylindre à bouton.

Cylinder with key way and inside knob.

Cilindro de 1 entrada de botón.

Designation	Boite	Colis.	Prix	Sachet	Colis.	Prix	Brochable					Colis.	Prix
							France	Euro 1	Euro 2	Euro 3	Euro 4		
Cylindre adaptateur rond T2 BLCT 33 x 33mm Ø 22mm 4 clés réversibles	00030140 NS	1	-	-	-	-	-	-	-	-	-	-	-
Cylindre adaptateur rond T2 BLCT 38 x 38mm Ø 22mm 4 clés réversibles	00030142 NS	1	-	-	-	-	-	-	-	-	-	-	-
Cylindre adaptateur rond T2 BLCT à bouton 33BT x 33mm Ø 22mm 4 clés réversibles	00030141 NS	1	-	-	-	-	-	-	-	-	-	-	-
Cylindre adaptateur rond T2 BLCT à bouton 38BT x 38mm Ø 22mm 4 clés réversibles	00030143 NS	1	-	-	-	-	-	-	-	-	-	-	-

NS Non stocké/Non-stored/Producto no estocado - ☑ Sur stock Europe Zone 1 et Zone 2, nous consulter pour délai d'approvisionnement - ☒ Epuisement/Stock depletion/Agotamiento del stock

Cylindre de haute sûreté / T2 FIC RESIST



GARANTIE



X 4

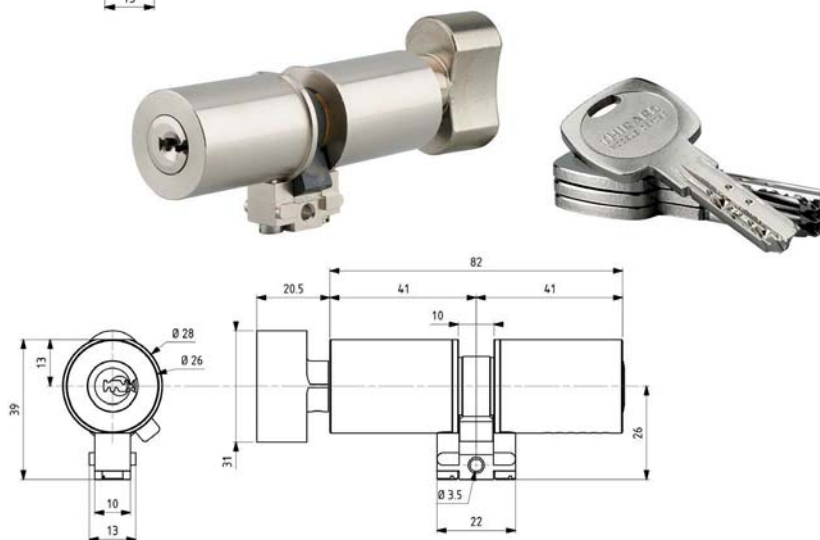
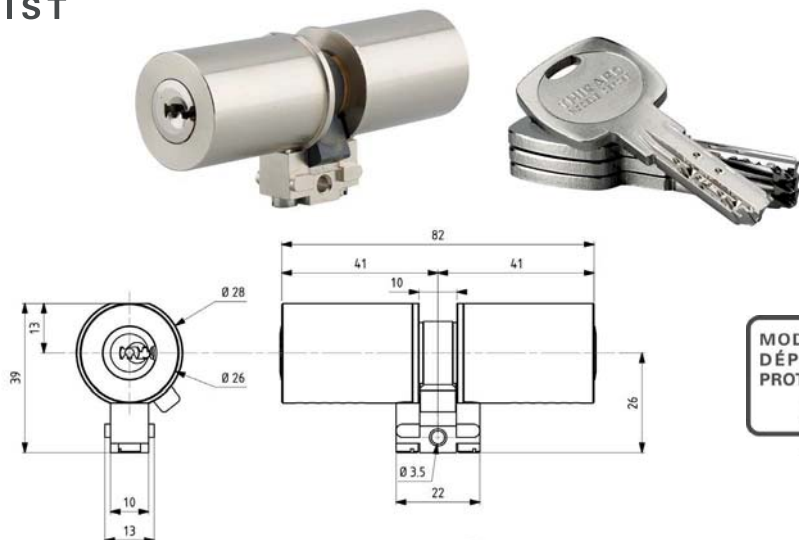

Description/Description/Descripción

Mécanisme à 8 goupilles (7 en maillechort et 1ère en acier trempé). Protection contre le perçage par 1ère goupille + poussoir en acier trempé Protection contre la casse par poutre en acier. 4 clés plates réversibles en laiton nickelé avec carte de propriété.

8 pin mechanism (7 nickel silver and first hardened steel pin). Protection against drilling by hardened steel pins. Protection against breaking by steel bar. 4 reversible brass nickel keys with a personal security card.

Mecanismo de 8 bombas (7 de alpaca y un pasador de acero templado). Protección contra el taladrado por un pasador de acero templado. Protección contra la rotura mediante una viga de acero. 4 llaves planas de latón niquelado reversibles patentadas con título de propiedad

Finition/Finish/Acabado

Nickel mat.

Matt nickel.

Níquel mate.

Version/Option/Versión

Cylindre à bouton.

Cylinder with key way and inside knob.

Cilindro de 1\~entrada de botón.

Designation	Boite	Colis.	Prix	Sachet	Colis.	Prix	Brochable					Colis.	Prix
							France	Euro 1	Euro 2	Euro 3	Euro 4		
Cylindre adaptateur rond T2 FIC 41 x 41mm Ø 26mm 4 clés réversibles	00030145 	1	-	-	-	-	-	-	-	-	-	-	-
Cylindre adaptateur rond T2 FIC à bouton 41BT x 41mm Ø 26mm 4 clés réversibles	00030146 	1	-	-	-	-	-	-	-	-	-	-	-

Non stocké/Non-stored/Producto no estocado - Sur stock Europe Zone 1 et Zone 2, nous consulter pour délai d'approvisionnement - Epuisement/Stock depletion/Agotamiento del stock



Cylindre de haute sûreté / ADAPTATEUR CAZ RESIST

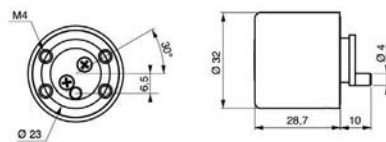
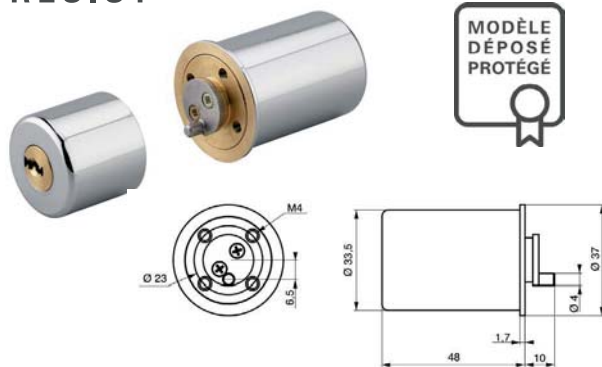

Description/Description/Descripción

Corps laiton. Mécanisme à 8 goupilles maillechort. 4 clés plates réversibles laiton nickelé brevetées avec carte de propriété.

Brass body. 8 nickel silver key pins. 4 patented nickel-plated brass reversible flat keys with ownership card.
Cuerpos de latón. Mecanismo de 8 pasadores de alpaca. 4 llaves planas reversibles de latón niquelado patentadas con tarjeta de propiedad.

Finition/Finish/Acabado

Nickelé / Nickel plated / Niquelado

Version/Option/Versión

Protection contre le perçage par 1ère goupille + poussoir en acier trempé.

Tempered steel anti-drilling protection to first key pin and driver pin.

Protección anti-perforación mediante primer pasador + aguja de acero templado.



GARANTIE



X 4

Designation	Boite	Colis.	Prix	Sachet	Colis.	Prix	Brochable					Colis.	Prix
							France	Euro 1	Euro 2	Euro 3	Euro 4		
Cylindre adaptateur rond T2 CAZ double cylindre 28 x 48mm Ø 33mm 4 clés réversibles	00030112 NS	1	-	-	-	-	-	-	-	-	-	-	-

Cylindre de haute sûreté / TRANSIT 2 À LANGUETTE RESIST

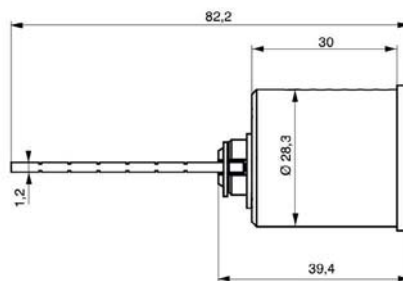
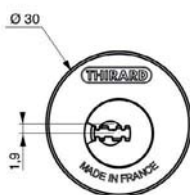

Description/Description/Descripción

Corps laiton. Mécanisme à 8 goupilles maillechort. Protection contre le perçage par 1ère goupille + poussoir en acier trempé. 4 clés plates réversibles laiton nickelé avec carte de propriété.

Brass body. Mechanism with 8 nickel silver key pins. Tempered steel anti-drilling protection to first key pin and driver pin. 4 flat nickel plated brass reversible keys with ownership card.

Cuerpos de latón. Mecanismo de 8 pasadores de alpaca. Protección anti-perforación mediante primer pasador + aguja de acero templado. 4 llaves planas de latón niquelado reversibles y patentadas con tarjeta de propiedad.

Finition/Finish/Acabado

Nickelé / Nickel plated / Niquelado



GARANTIE



X 4

Designation	Boite	Colis.	Prix	Sachet	Colis.	Prix	Brochable					Colis.	Prix
							France	Euro 1	Euro 2	Euro 3	Euro 4		
Cylindre rond TRANSIT 2 Ø 30mm à languette 4 clés réversibles	00030406 NS	1	-	-	-	-	-	-	-	-	-	-	-

NS Non stocké/Non-stored/Producto no estocado - ☑ Sur stock Europe Zone 1 et Zone 2, nous consulter pour délai d'approvisionnement - ☒ Epuisement/Stock depletion/Agotamiento del stock

Accessoires / OBTURATEUR ECO



GARANTIE

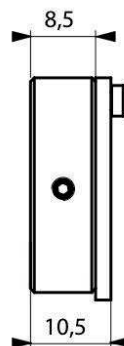
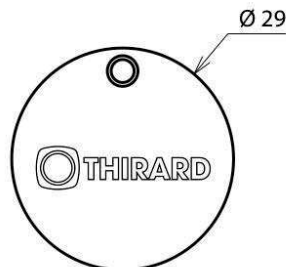

Description/Description/Descripción

Corps et cache en laiton chromé. Fixation par vis pointeau sur le corps du cylindre profilé.

Body and cover chrome plated brass. Screw fixing on the needle body of the profile cylinder.

Cuerpo y tapa en latón cromado. Fijación con tornillos embutidos sobre el cuerpo del cilindro perfilado.

Finition/Finish/Acabado

Chromé

Chrome plated

Cromado

Designation	Boite	Colis.	Prix	Sachet	Colis.	Prix	Brochable					Colis.	Prix
							France	Euro 1	Euro 2	Euro 3	Euro 4		
Obturateur pour cylindre profilé européen	00019942	10	-	00919942	10	-	00119942	-	-	-	-	10	-

Accessoires ENTREE / ROSACE ECO



GARANTIE

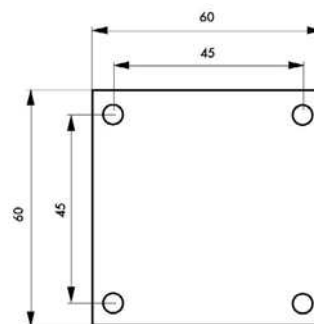
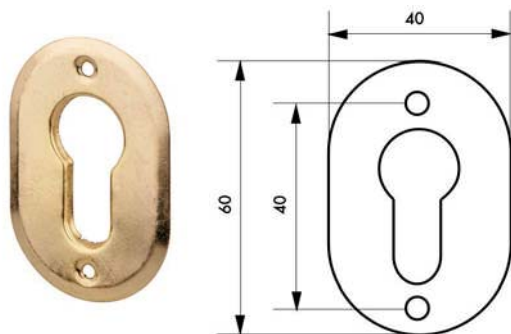

Description/Description/Descripción

Acier

Steel

Acero

Finition/Finish/Acabado

Laiton

Brass

Latón

Designation	Boite	Colis.	Prix	Sachet	Colis.	Prix	Brochable					Colis.	Prix
							France	Euro 1	Euro 2	Euro 3	Euro 4		
Rosace pour cylindre profilé européen	00082900	10	-	-	-	-	00182900	-	-	-	-	10	-
Plaque de propreté laiton 60 x 60 mm	00041266	10	-	-	-	-	00141266	-	-	-	-	10	-

⚠ Non stocké/Non-stored/Producto no estocado - 📦 Sur stock Europe Zone 1 et Zone 2, nous consulter pour délai d'approvisionnement - 🇪🇺 Epuement/Stock depletion/Agotamiento del stock



Pour serrure à encastrer / ADAPTATEUR CLE DE SERVICE ECO



GARANTIE

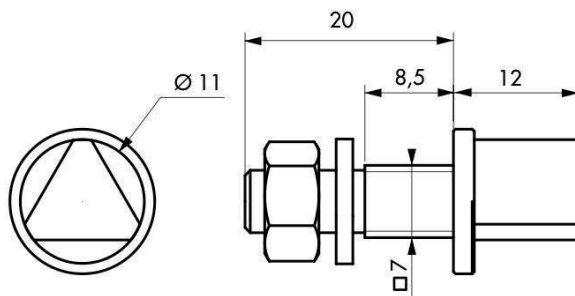

Description/Description/Descripción

Triangle 11 mm ou 14 mm en laiton. Carré de 7 mm. Erou et rondelle acier zingué.

Brass triangle 11 mm or 14 mm. Square 7 mm. Nut and washer zinc plated steel.

Triángulo 11mm o 14 mm en latón - Cuadrado 7 mm. Tuerca y arandela de acero zincado

Finition/Finish/Acabado

Laiton

Brass

Latón

Designation	Boite	Colis.	Prix	Sachet	Colis.	Prix	Brochable					Colis.	Prix
							France	Euro 1	Euro 2	Euro 3	Euro 4		
Adaptateur triangle 11 mm pour fouillot carré 7 mm	00019941	10	-	-	-	-	-	-	-	-	-	-	-
Adaptateur triangle 14 mm pour fouillot carré 7 mm	00019943	10	-	-	-	-	-	-	-	-	-	-	-

Accessoires / ANNEAU PORTE-ETIQUETTE

ECO

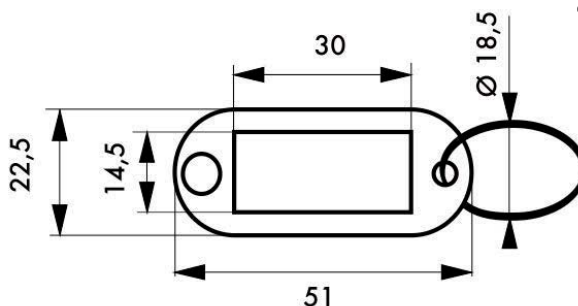

GARANTIE

Description/Description/Descripción

Porte-étiquette PVC.

PVC card holder.

Portaetiqueta PVC.

Finition/Finish/Acabado

Couleurs assorties

Assorted colors

Colores surtidos

Utilisation/Use/Utilización

Identification de clé

Key identification

Identificación de la llave

Designation	Boite	Colis.	Prix	Sachet	Colis.	Prix	Brochable					Colis.	Prix
							France	Euro 1	Euro 2	Euro 3	Euro 4		
Anneau porte-étiquette couleurs assorties (2 pièces conditionnement brochable)	00098309	10	-	-	-	-	-	-	-	-	-	-	-

⚠ Non stocké/Non-stored/Producto no estocado - 📦 Sur stock Europe Zone 1 et Zone 2, nous consulter pour délai d'approvisionnement - 📦 Epuisement/Stock depletion/Agotamiento del stock

Accessoires / ANNEAU PORTE-ETIQUETTE

ECO

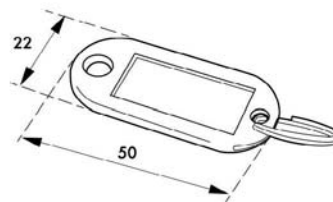

GARANTIE

Description/Description/Descripción

Porte-étiquette PVC. Anneau fendu.

PVC label holder. Split ring.

Portaetiquetas de PVC. Llaveo dividido.

Finition/Finish/Acabado

Couleurs assorties / Assorted colors / Colores surtidos

Utilisation/Use/Utilización

Identification de clé

Key identification

Identificación de la llave

Designation	Boite	Colis.	Prix	Sachet	Colis.	Prix	Brochable					Colis.	Prix
							France	Euro 1	Euro 2	Euro 3	Euro 4		
Porte étiquette 50x22mm - 10 pièces couleurs assorties	-	-	-	00998321	10	-	-	-	-	-	-	-	-
Porte étiquette 50x22mm - 5 pièces - Jaune	-	-	-	00998336	10	-	-	-	-	-	-	-	-
Porte étiquette 50x22mm - 5 pièces - Rouge	-	-	-	00998337	10	-	-	-	-	-	-	-	-
Porte étiquette 50x22mm - 5 pièces - Vert	-	-	-	00998338	10	-	-	-	-	-	-	-	-
Porte étiquette 50x22mm - 5 pièces - Noir	-	-	-	00998339	10	-	-	-	-	-	-	-	-
Porte étiquette 50x22mm - 5 pièces - Bleu	-	-	-	00998340	10	-	-	-	-	-	-	-	-

Accessoires / ANNEAU PORTE-ETIQUETTE

ECO

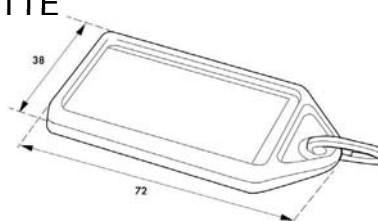

GARANTIE

Description/Description/Descripción

Porte-étiquette PVC. Anneau fendu.

PVC label holder. Split ring.

Portaetiquetas de PVC. Llaveo dividido.

Finition/Finish/Acabado

Couleurs assorties / Assorted colors / Colores surtidos

Utilisation/Use/Utilización

Identification de clé

Key identification

Identificación de la llave

Designation	Boite	Colis.	Prix	Sachet	Colis.	Prix	Brochable					Colis.	Prix
							France	Euro 1	Euro 2	Euro 3	Euro 4		
Porte étiquette 73x38mm - sachet de 10 pièces	-	-	-	00998323	10	-	-	-	-	-	-	-	-
Porte étiquette 57x29mm - sachet de 10 pièces couleurs assorties	-	-	-	00998322	10	-	-	-	-	-	-	-	-
Porte étiquette 57x29mm - 5 pièces - Jaune	-	-	-	00998331	10	-	-	-	-	-	-	-	-
Porte étiquette 57x29mm - 5 pièces - Rouge	-	-	-	00998332	10	-	-	-	-	-	-	-	-
Porte étiquette 57x29mm - 5 pièces - Vert	-	-	-	00998333	10	-	-	-	-	-	-	-	-
Porte étiquette 57x29mm - 5 pièces - Noir	-	-	-	00998334	10	-	-	-	-	-	-	-	-
Porte étiquette 57x29mm - 5 pièces - Bleu	-	-	-	00998335	10	-	-	-	-	-	-	-	-

Non stocké/Non-stored/Producto no estocado - Sur stock Europe Zone 1 et Zone 2, nous consulter pour délai d'approvisionnement - Epuisement/Stock depletion/Agotamiento del stock

Accessoires / PORTE CLÉ ENROULEUR ECO



GARANTIE



Description/Description/Descripción

Corps acier. Chaîne acier rétractable . Anneau fendu. Clip de ceinture.

Steel body. Retractable steel chain. Split ring. Belt clip.

Cuerpo de acero. Cadena de acero retráctil. Anillo dividido. Clip para el cinturón.

Finition/Finish/Acabado

Nickelé.

Nickel plated

Niquelado

Designation	Boite	Colis.	Prix	Sachet	Colis.	Prix	Brochable					Colis.	Prix
							France	Euro 1	Euro 2	Euro 3	Euro 4		
Porte-clés à chaîne rétractable 600mm	-	-	-	00998324	10	-	-	-	-	-	-	-	-
Porte-clés à câble rétractable 1200mm	-	-	-	00998325	10	-	-	-	-	-	-	-	-

Accessoires / PORTE-CLÉ ECO



GARANTIE

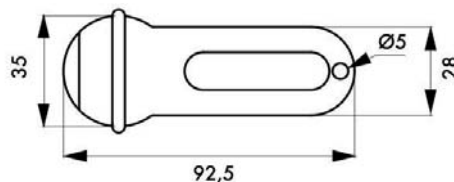
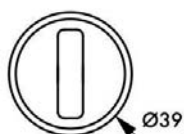

Description/Description/Descripción

Alliage moulé. Bague caoutchouc.

Moulded alloy. Rubber ring.

Aleación moldeada. Anillo de caucho.

Finition/Finish/Acabado

Chromé satiné

Satin chrome

Cromado satina

Designation	Boite	Colis.	Prix	Sachet	Colis.	Prix	Brochable					Colis.	Prix
							France	Euro 1	Euro 2	Euro 3	Euro 4		
Porte-clé Hôtel	00013900	10	-	-	-	-	-	-	-	-	-	-	-

⚠ Non stocké/Non-stored/Producto no estocado - 📦 Sur stock Europe Zone 1 et Zone 2, nous consulter pour délai d'approvisionnement - 📦 Epuisement/Stock depletion/Agotamiento del stock

Norme / EN 1303 - 2005

Elle s'applique aux cylindres destinés aux serrures normalement utilisées dans le bâtiment et qui sont conçues pour être utilisées avec des cylindres.

Cette norme définit les performances et autres exigences du cylindre et de leur clé pour les caractéristiques suivantes :

- résistance de la clé,
- endurance (nombre de cycles),
- niveau de sécurité relatives à la clé (conception du mécanisme de verrouillage),
- résistance à l'attaque,
- résistance à la corrosion,
- bon fonctionnement aux températures extrêmes,
- aptitude à être utilisés sur des blocs portes coupe feu et/ou étanches aux fumées.

Parmi ces critères, **3** sont déterminants pour définir le niveau de sécurité et de qualité du cylindre :

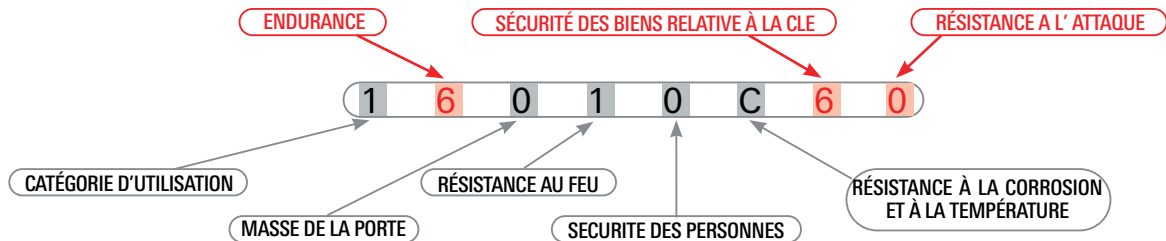

DESCRIPTION DE LA CLASSIFICATION

Catégorie d'utilisation.

Grade 1 : utilisation par des personnes très soigneuses et où il y a un faible risque de mauvaise utilisation. Endurance.

Grade 4 : 25 000 cycles d'essai

Grade 5 : 50 000 cycles d'essai

Grade 6 : 100 000 cycles d'essai.

Masse de la porte.

Grade 0 : pas d'exigence de masse de la porte.

Résistance au feu.

Grade 0 : inapte à l'utilisation sur des blocs-portes coupe-feu et/ou étanches aux fumées

Grade 1 : apte à l'utilisation sur des blocs-portes coupe-feu et/ou étanches aux fumées à condition que la contribution des cylindres à la résistance au feu des blocs-portes coupe-feu et/ou étanches aux fumées spécifiée soit prouvée de façon satisfaisante.

Sécurité des personnes.

Grade 0 : pas d'exigence de sécurité des personnes.

Résistance à la corrosion et à la température.

Grade 0 : aucune exigence de résistance à la corrosion ; pas d'exigence de température

Grade A : résistance élevée à la corrosion ; aucune exigence de température

Grade B : aucune exigence de résistance à la corrosion ; exigence de température : entre -20°C et + 80°C

Grade C : résistance élevée à la corrosion ; exigence de température : entre -20°C et + 80°C.

Sécurité des biens relative à la clé.

Nombre minimal de variations effectives.

Grade 1 : 100-Codage direct / Grade 2 : 300-Codage direct / Grade 3 : 15 000-Codage indirect

Grade 4 : 30 000-Codage indirect / Grade 5 : 30 000-Codage indirect / Grade 6 : 100 000-Codage indirect.

Résistance à l'attaque (perçage, burin, torsion, extraction, rotation du rotor et/ou du cylindre)

Grade 0 : Pas de résistance au perçage, pas de résistance aux attaques mécaniques

Grade 1 : 3/5 minutes de résistance au perçage, résistance aux attaques mécaniques (niveau 1)

Grade 2 : 5/10 minutes de résistance au perçage, résistance aux attaques mécaniques (niveau 2).

Il existe deux 2 types de certification :

- la certification par organisme extérieur (laboratoire accrédité),
- l'autocertification (laboratoire d'essais interne).

Comment reconnaît-on un cylindre classifié selon la norme EN 1303 :

- description sur la documentation commerciale,
- mise à disposition sur demande du certificat du laboratoire d'essais (externe ou interne),
- marquage de l'emballage,
- présence d'une notice de pose et d'entretien spécifique.



SUPPLÉMENTS / POUR CYLINDRES

Designation	Boite	Colis.	Prix	Sachet	Colis.	Prix	Brochable					Colis.	Prix
							France	Euro 1	Euro 2	Euro 3	Euro 4		
SUPPLÉMENTS POUR CYLINDRES PROFILS 5 ET 6 GOUPILLES HG													
Supplément pour entr'ouverture (pour quantité < 50 pièces)	00063001	-	-		-	-	-	-	-	-	-	-	-
Supplément pour entr'ouverture hors standard (pour quantité < 50 pièces)	00063991	-	-		-	-	-	-	-	-	-	-	-
Supplément pour numéro imposé (pour quantité < 50 pièces)	00056009	-	-		-	-	-	-	-	-	-	-	-
Supplément pour ouverture centrale	00056001	-	-		-	-	-	-	-	-	-	-	-
Supplément pour ouverture sur passe général simple	00056002	-	-		-	-	-	-	-	-	-	-	-
Supplément pour ouverture sur passe général et passe partiel	00056003	-	-		-	-	-	-	-	-	-	-	-
Supplément par cylindre en extension d'organigramme autre que le distributeur d'origine	00056022	-	-		-	-	-	-	-	-	-	-	-
Clé passe général HG 5 - HG 6	00056012	-	-		-	-	-	-	-	-	-	-	-
Clé passe-partiel HG 5 - HG 6	00056013	-	-		-	-	-	-	-	-	-	-	-
Clé passe général HG 5 +	00058801	-	-		-	-	-	-	-	-	-	-	-
Clé passe-partiel HG 5 +	00058802	-	-		-	-	-	-	-	-	-	-	-
Minoration par Clé en moins (Prix net)	00056019	-	-		-	-	-	-	-	-	-	-	-
Supplément pour protection anti perçage	00056021	-	-		-	-	-	-	-	-	-	-	-
Marquage Supplémentaire sur stator ou Clé	00056020	-	-		-	-	-	-	-	-	-	-	-
Supplément pour panneton débrayable	00056023	-	-		-	-	-	-	-	-	-	-	-
Supplément pour panneton orientable	00056025	-	-		-	-	-	-	-	-	-	-	-
Supplément pour bouton débrayable (fonction Urgence)	00056026	-	-		-	-	-	-	-	-	-	-	-
Supplément pour panneton réduit	00056031	-	-		-	-	-	-	-	-	-	-	-
Supplément pour dorure	00056024	-	-		-	-	-	-	-	-	-	-	-
Supplément pour poli verni	00056029	-	-		-	-	-	-	-	-	-	-	-
LUBRIFIANT poudre graphite 95 ml pour cylindre	00096005	-	-		-	-	-	-	-	-	-	-	-
PRESENTOIR de 20 burettes LUBRIFIANT poudre graphite 95 ml pour cylindre	00096205	-	-		-	-	-	-	-	-	-	-	-
SUPPLÉMENTS POUR CYLINDRES DE HAUTE SÛRETÉ ADRIA													
Supplément pour ouverture sur passe général simple	00047003	-	-		-	-	-	-	-	-	-	-	-
Supplément pour ouverture sur passe général et passe partiel	00047004	-	-		-	-	-	-	-	-	-	-	-

Designation	Boite	Colis.	Prix	Sachet	Colis.	Prix	Brochable					Colis.	Prix
							France	Euro 1	Euro 2	Euro 3	Euro 4		
Supplément par cylindre en extension d'organigramme autre que le distributeur d'origine	00056022	-	-		-	-	-	-	-	-	-	-	-
Clé supplémentaire	00047009	-	-		-	-	-	-	-	-	-	-	-
Clé passe général	00047006	-	-		-	-	-	-	-	-	-	-	-
Clé passe-partiel	00047007	-	-		-	-	-	-	-	-	-	-	-
Minoration par Clé en moins (Prix net)	00047008	-	-		-	-	-	-	-	-	-	-	-
Supplément pour protection anti perçage	00056021	-	-		-	-	-	-	-	-	-	-	-
Marquage Supplémentaire sur stator ou Clé	00056020	-	-		-	-	-	-	-	-	-	-	-
Supplément pour bouton débrayable (fonction Urgence)	00056026	-	-		-	-	-	-	-	-	-	-	-
Supplément pour panneton débrayable (fonction Urgence)	00056023	-	-		-	-	-	-	-	-	-	-	-
Supplément pour panneton réduit	00056031	-	-		-	-	-	-	-	-	-	-	-

SUPPLEMENTS POUR CYLINDRES DE HAUTE SÛRETÉ ADRIATIC

Supplément pour numéro imposé (pour quantité < 50 pièces)	00049001	-	-		-	-	-	-	-	-	-	-	-
Supplément pour ouverture centrale	00049002	-	-		-	-	-	-	-	-	-	-	-
Supplément pour ouverture sur passe général simple	00049003	-	-		-	-	-	-	-	-	-	-	-
Supplément pour ouverture sur passe général et passe partiel	00049004	-	-		-	-	-	-	-	-	-	-	-
Supplément par cylindre en extension d'organigramme autre que le distributeur d'origine	00056022	-	-		-	-	-	-	-	-	-	-	-
Clé supplémentaire	00049009	-	-		-	-	-	-	-	-	-	-	-
Clé passe général	00049006	-	-		-	-	-	-	-	-	-	-	-
Clé passe-partiel	00049007	-	-		-	-	-	-	-	-	-	-	-
Minoration par Clé en moins (Prix net)	00049008	-	-		-	-	-	-	-	-	-	-	-
Supplément pour protection anti perçage	00056021	-	-		-	-	-	-	-	-	-	-	-
Marquage Supplémentaire sur stator ou Clé	00056020	-	-		-	-	-	-	-	-	-	-	-
Supplément pour bouton débrayable (fonction Urgence)	00056026	-	-		-	-	-	-	-	-	-	-	-
Supplément pour panneton débrayable (fonction Urgence)	00056023	-	-		-	-	-	-	-	-	-	-	-
Supplément pour panneton réduit	00056031	-	-		-	-	-	-	-	-	-	-	-

SUPPLEMENTS POUR CYLINDRES DE HAUTE SÛRETÉ SURVEYOR

Supplément pour entr'ouverture (pour quantité < 50 pièces)	00063001	-	-		-	-	-	-	-	-	-	-	-
--	----------	---	---	--	---	---	---	---	---	---	---	---	---

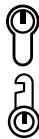

Designation	Boite	Colis.	Prix	Sachet	Colis.	Prix	Brochable					Colis.	Prix
							France	Euro 1	Euro 2	Euro 3	Euro 4		
Supplément pour entr'ouverture hors standard (pour quantité < 50 pièces)	00063991	-	-		-	-	-	-	-	-	-	-	-
Supplément pour ouverture sur numéro imposé (pour quantité < 50 pièces)	00016700	-	-		-	-	-	-	-	-	-	-	-
Supplément pour mise sur passe général	00016701	-	-		-	-	-	-	-	-	-	-	-
Supplément pour mise sur passe général et passe-partiel	00016702	-	-		-	-	-	-	-	-	-	-	-
Supplément pour mise sur combinaison centrale	00016703	-	-		-	-	-	-	-	-	-	-	-
Clé passe-partout	00016704	-	-		-	-	-	-	-	-	-	-	-
Clé passe-partiel	00016705	-	-		-	-	-	-	-	-	-	-	-
Minoration pour non fourniture de clé (prix net par clé)	00016707	-	-		-	-	-	-	-	-	-	-	-
Supplément panneton réduit pour cylindre à pompes	00016710	-	-		-	-	-	-	-	-	-	-	-

SUPPLEMENTS POUR CYLINDRES DE HAUTE SÛRETÉ COBRA 2 ET COBRA 2+

Supplément pour entr'ouverture (pour quantité < 50 pièces)	00063001	-	-		-	-	-	-	-	-	-	-	-
Supplément pour entr'ouverture hors standard (pour quantité < 50 pièces)	00063991	-	-		-	-	-	-	-	-	-	-	-
Supplément pour ouverture sur numéro imposé (pour quantité < 50 pièces)	00040700	-	-		-	-	-	-	-	-	-	-	-
Supplément pour ouverture sur passe général simple	00040701	-	-		-	-	-	-	-	-	-	-	-
Supplément pour ouverture sur passe général et passe-partiel	00040702	-	-		-	-	-	-	-	-	-	-	-
Supplément pour mise sur combinaison centrale	00040703	-	-		-	-	-	-	-	-	-	-	-
Clé passe-général	00040704	-	-		-	-	-	-	-	-	-	-	-
Clé passe-partiel	00040705	-	-		-	-	-	-	-	-	-	-	-
Supplément pour dorure cylindre	00040698	-	-		-	-	-	-	-	-	-	-	-
Supplément pour dorure cylindre bouton	00040699	-	-		-	-	-	-	-	-	-	-	-
Minoration pour non fourniture de clé (prix net par clé)	00040706	-	-		-	-	-	-	-	-	-	-	-

SUPPLEMENTS POUR CYLINDRES DE HAUTE SÛRETÉ TRANSIT 2

Supplément pour panneton débrayable (fonction Urgence)	00015002	-	-		-	-	-	-	-	-	-	-	-
Supplément pour bouton débrayable (fonction Urgence)	00056026	-	-		-	-	-	-	-	-	-	-	-
Supplément pour entr'ouverture (pour quantité < 50 pièces) TRANSIT 2	00063001	-	-		-	-	-	-	-	-	-	-	-
Supplément pour entr'ouverture hors standard (pour quantité < 50 pièces) TRANSIT 2	00063991	-	-		-	-	-	-	-	-	-	-	-

Designation	Boite	Colis.	Prix	Sachet	Colis.	Prix	Brochable					Colis.	Prix
							France	Euro 1	Euro 2	Euro 3	Euro 4		
Supplément pour ouverture sur numéro imposé (pour quantité < 50 pièces) TRANSIT 2	00018792	-	-		-	-	-	-	-	-	-	-	-
Supplément pour ouverture sur passe général simple TRANSIT 2	00057021	-	-		-	-	-	-	-	-	-	-	-
Supplément pour ouverture sur passe général et passe-partiel TRANSIT 2	00057022	-	-		-	-	-	-	-	-	-	-	-
Supplément pour mise sur combinaison centrale TRANSIT 2	00057020	-	-		-	-	-	-	-	-	-	-	-
Clé passe général TRANSIT 2	00058002	-	-		-	-	-	-	-	-	-	-	-
Clé passe-partiel TRANSIT 2	00058003	-	-		-	-	-	-	-	-	-	-	-
Minoration pour clé non fournie (prix net par clé) TRANSIT 2	00018794	-	-		-	-	-	-	-	-	-	-	-
Supplément pour panneton réduit	00056031	-	-		-	-	-	-	-	-	-	-	-
Autres dimensions sur demande	-	-	-		-	-	-	-	-	-	-	-	-
CYLINDRES À GOUPILLES ET À POMPES													
Cylindre à goupilles Ø 21 - 30 à 50 mm 3 clés	00021330	-	-		-	-	-	-	-	-	-	-	-
Cylindre à goupilles Ø 23 - 30 à 50 mm 3 clés	00023330	-	-		-	-	-	-	-	-	-	-	-
Cylindre à goupilles DC Ø 21 - 30 à 50 mm 3 clés	00021340	-	-		-	-	-	-	-	-	-	-	-
Cylindre à goupilles DC Ø 23 - 30 à 50 mm 3 clés	00023340	-	-		-	-	-	-	-	-	-	-	-
Cylindre à goupilles TRANSIT Ø 23 - 30 à 50 mm 3 clés	00018135	-	-		-	-	-	-	-	-	-	-	-
Cylindre à goupilles TRANSIT DC Ø 23 - 30 à 50 mm 3 clés	00018235	-	-		-	-	-	-	-	-	-	-	-
Cylindre à pompes SURVEYOR Ø 23 - 40 à 50 mm 4 clés	00023730	-	-		-	-	-	-	-	-	-	-	-
Cylindre à pompes SURVEYOR DC Ø 23 - 40 à 50 mm 4 clés	00023740	-	-		-	-	-	-	-	-	-	-	-
Cylindre à pompes COBRA Ø 23 - 45 mm 4 clés	00023830	-	-		-	-	-	-	-	-	-	-	-
Cylindre à pompes COBRA DC Ø 23 - 45 mm 4 clés	00023840	-	-		-	-	-	-	-	-	-	-	-
SUPPLEMENTS POUR CYLINDRES DE HAUTE SÛRETÉ FEDERAL 2													
Supplément pour entr'ouverture (pour quantité < 50 pièces) FEDERAL 2	-	-	-		-	-	-	-	-	-	-	-	-
Supplément pour entr'ouverture hors standard (pour quantité < 50 pièces) FEDERAL 2	-	-	-		-	-	-	-	-	-	-	-	-
Supplément pour ouverture sur numéro imposé (pour quantité < 50 pièces) FEDERAL 2	-	-	-		-	-	-	-	-	-	-	-	-
Minoration pour clé non fournie (prix net par clé) FEDERAL 2	-	-	-		-	-	-	-	-	-	-	-	-











Batteuses

ECO
PROTECT
RESIST







BATTEUSE BOITE AUX LETTRES



Came 12 H		577
Came plate		578
Came plate +coudée		579
Came coudée		580
Came plate + came coudée		580
Came coudée		582
Came à combinaison		583

BATTEUSE INDUSTRIE



Came plate		585
Came SURVEYOR		586
Came COBRA M		586
CONTACTEUR		
Contacteur		587
Contacteur à clé		588
Contacteur à clé		589



Batteuse / CAME 12H

ECO



GARANTIE



X 2



017914



017915

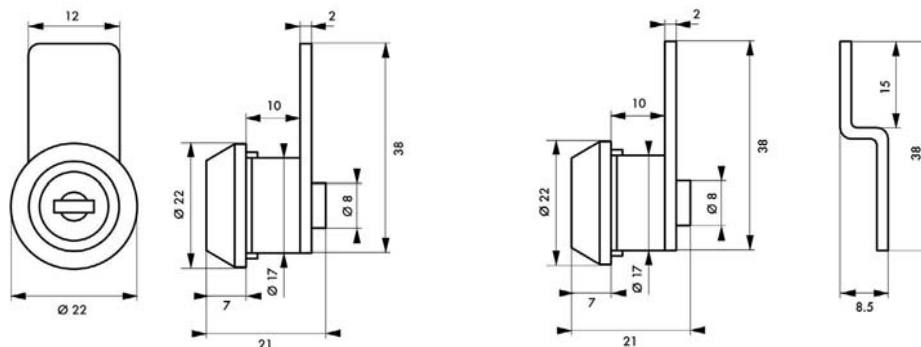
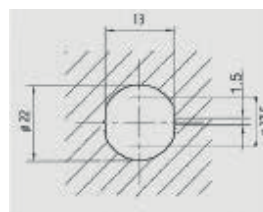

017914
017915

Description/Description/Descripción

Corps alliage moulé. Mécanisme à paillettes. Came montée à 12 h. 2 clés nickelées. Clip de fixation.
Moulded alloy body. Disc tumblers mechanism. Flat cam adjusted at 12 o'clock. 2 nickel plated keys. Fixing click.
Cuerpo de aleación moldeada. Mecanismo de plaquitas. Leva plana montada a 12 h. 2 llaves niqueladas. Clip de fijación.

Finition/Finish/Acabado

Nickelé
Nickel plated
Niquelado

Version/Option/Versión

017904 - Avec came coudée vers la face pour tôle ép. 0,0 à 1,2 mm

017905 - Avec came plate pour tôle ép. 0,8 à 1,3 mm
017914 - Avec came plate pour tôle ép. 0,8 à 1,2 mm
017915 - Avec came coudée vers la face our tôle ép. 0,8 à 1,2 mm
017924 - Avec came plate pour tôle ép. 0,0 à 1,2 mm

With bended cam. Steel sheet thickness from 0,8 to 1,2 mm

Con leva acodada hacia la cara. Buzones de metal 0,8 a 1,2 mm de espesor

Utilisation/Use/Utilización

Boîtes aux lettres
Letter boxes
Buzones de chapa

Batteuse / CAME 12H

ECO



017904



017905

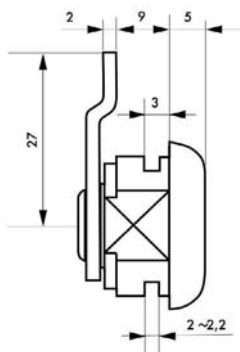

017904

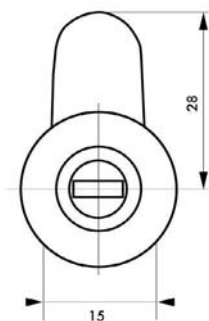

017905

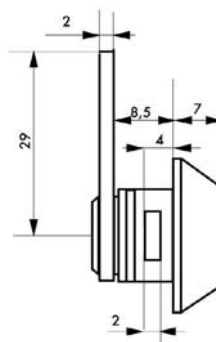

Designation	Boite	Colis.	Prix	Sachet	Colis.	Prix	Brochable					Colis.	Prix
							France	Euro 1	Euro 2	Euro 3	Euro 4		
Batteuse avec came à 12 h plate	-	-	-	00917914	20	-	00117914	00193179 NS	00192179 NS	00194179	-	10	-
Batteuse avec came à 12 h coudée	-	-	-	00917915	20	-	00117915	00193178 NS	00192178 NS	00194178	-	10	-
Batteuse avec came à 12 h coudée vers la face	-	-	-	00917904	20	-	00117904	-	00192231 NS	-	-	10	-
Batteuse avec came à 12 h coudée vers la face	-	-	-	00917905	20	-	00117905	-	00192232 NS	-	-	10	-
Batteuse avec came à 12 h plate	-	-	-	00917924	20	-	-	-	-	-	-	-	-

NS Non stocké/Non-stored/Producto no estocado - Sur stock Europe Zone 1 et Zone 2, nous consulter pour délai d'approvisionnement - E Epuisement/Stock depletion/Agotamiento del stock

Batteuse / CAME PLATE

ECO



GARANTIE



X 2



017916

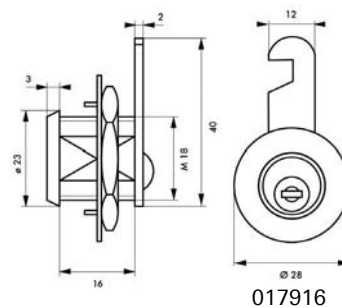

017916



017930

017930

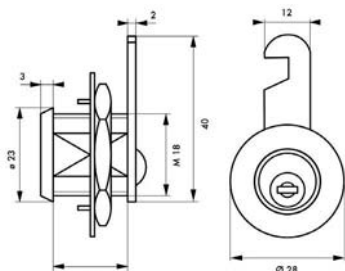

017920

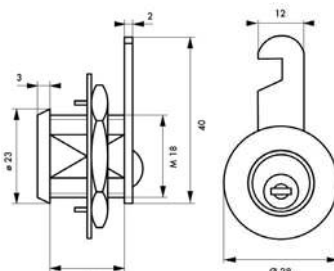

017925

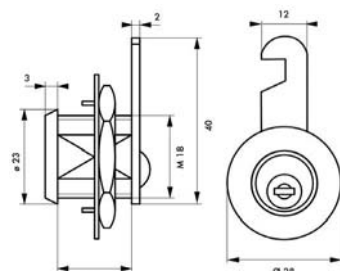

017930

Description/Description/Descripción

Corps alliage moulé. Mécanisme à paillettes. Came plate.
2 clés nickelées gainées PVC. Erou et griffe de fixation.
*Moulded alloy body. Disc tumblers mechanism. Flat cam.
2 nickel plated keys with head protector by a PVC shell.
Nut and fixing click.*

Cuerpo de aleación moldeada. Mecanismo de plaquitas.
Leva plana. 2 llaves niqueladas con revestimiento de
PVC. Tuerca y garra de fijación.

Finition/Finish/Acabado

Nickelé

Nickel plated

Niquelado

Version/Option/Versión

Longueur 18 mm - 20 mm - 25 mm - 30 mm.

Long. 18 mm - 20 mm - 25 mm - 30 mm.

Long. 18 mm - 20 mm - 25 mm - 30 mm.

Utilisation/Use/Utilización

Boîtes aux lettres

Letter boxes

Buzones de chapa

Designation	Boite	Colis.	Prix	Sachet	Colis.	Prix	Brochable					Colis.	Prix
							France	Euro 1	Euro 2	Euro 3	Euro 4		
Batteuse 16 mm pour ép. maxi 12 mm	-	-	-	00917916	20	-	00117916	00193180 NS	00192180 NS	00194180	-	10	-
Batteuse 20 mm pour ép. maxi 14 mm	-	-	-	00917920	20	-	00117920	00193181 NS	00192181 NS	00194181	-	10	-
Batteuse 25 mm pour ép. maxi 19 mm	-	-	-	00917925	20	-	00117925	00193182 NS	00192182 NS	00194182	-	10	-
Batteuse 30 mm pour ép. maxi 24 mm	-	-	-	00917930	20	-	00117930	00193183 NS	00192183 NS	00194183	-	10	-

NS Non stocké/Non-stored/Producto no estocado - ☑ Sur stock Europe Zone 1 et Zone 2, nous consulter pour délai d'approvisionnement - ☒ Epuisement/Stock depletion/Agotamiento del stock

Batteuse / CAME PLATE + COUDEE

ECO



GARANTIE



X 2

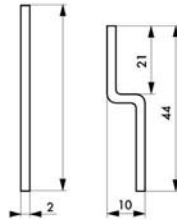
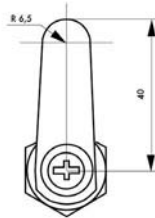
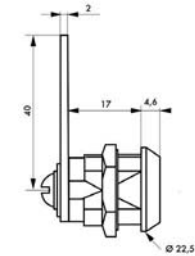

017900

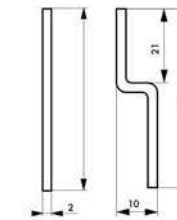
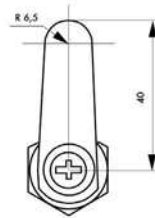
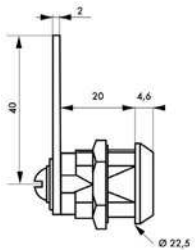
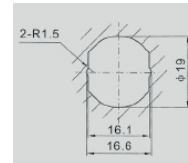

017901

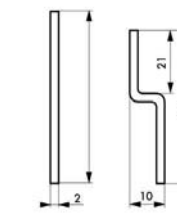
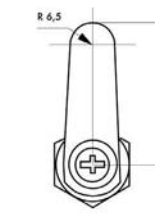
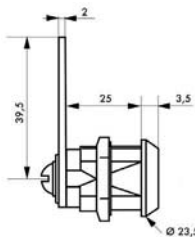
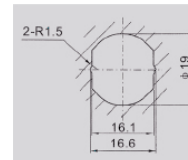

017902

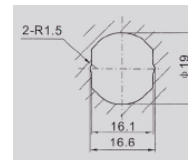

Description/Description/Descripción

Corps alliage moulé. Mécanisme à paillettes. 1 came plate + 1 came coudee. 2 clés nickelées gainées PVC. Ecrou de fixation.

Moulded alloy body. Disc tumblers mechanism. Flat cam. 2 nickel plated keys with head protector by a PVC shell. Nut and fixing click.

Cuerpo de aleación moldeada. Mecanismo de plaquitas. Leva plana. 2 llaves niqueladas con revestimiento de PVC. Tuerca y garra de fijación.

Version/Option/Versión

017900 - pour épaisseur 0 à 12 mm

017901 - pour épaisseur 0 à 14 mm

017902 - pour épaisseur 0 à 24 mm

017900 - for thickness from 0 to 12 mm

017901 - for thickness from 0 to 14 mm

017902 - for thickness from 0 to 24 mm

017900 - para espesor de 0 a 12 mm

017901 - para espesor de 0 a 14 mm

017902 - para espesor de 0 a 24 mm

Utilisation/Use/Utilización

Boîtes aux lettres bois et métal

Wood and metal letter boxes

Buzones de madera y de metal

Designation	Boîte	Colis.	Prix	Sachet	Colis.	Prix	Brochable					Colis.	Prix
							France	Euro 1	Euro 2	Euro 3	Euro 4		
Batteuse avec cames pour ép. maxi 12 mm	-	-	-	00917900	20	-	00117900	00193233 NSI	00192233 NSI	00194233	-	10	-
Batteuse avec cames pour ép. maxi 14 mm	-	-	-	00917901	20	-	00117901	00193234 NSI	00192234 NSI	00194234	-	10	-
Batteuse avec cames pour ép. maxi 24 mm	-	-	-	00917902	20	-	00117902	00193184 NSI	00192184 NSI	00194184	-	10	-

NS Non stocké/Non-stored/Producto no estocado - Sur stock Europe Zone 1 et Zone 2, nous consulter pour délai d'approvisionnement - E Epuisement/Stock depletion/Agotamiento del stock



Batteuse / CAME COUDEE

ECO



Description/Description/Descripción

Corps alliage moulé. Mécanisme à paillettes. Came coudeée. 2 clés nickelées. Ecrou de fixation.

Moulded alloy body. Disc tumblers mechanism cam. 2 nickel plated keys. Fixing click.

Cuerpo de aleación moldeada. Mecanismo de plaquitas. Leva plana. 2 llaves niqueladas. garra de fijación.

Finition/Finish/Acabado

Nickelé / Nickel plated / Niquelado

Utilisation/Use/Utilización

Boîtes aux lettres épaisseur 0 à 6mm

Letter boxes 0 to 6 mm max

Buzones 0 to 6 mm max



GARANTIE



X 2

Designation	Boite	Colis.	Prix	Sachet	Colis.	Prix	Brochable					Colis.	Prix
							France	Euro 1	Euro 2	Euro 3	Euro 4		
Batteuse avec came pour ép. maxi 6 mm	-	-	-	00917903	20	-	00117903	00193186 NS	00192186 NS	00194186	-	10	-

Batteuse / CAME COUDEE

ECO



Description/Description/Descripción

Corps alliage moulé. Mécanisme à goupilles. Came coudeée. 2 clés nickelées gainées PVC. Ecrou de fixation.

Moulded alloy body. Disc tumblers mechanism cam. 2 nickel plated keys with head protector by a PVC shell.

Cuerpo de aleación moldeada. Mecanismo de plaquitas. Leva plana. 2 llaves niqueladas con revestimiento de PVC.

Finition/Finish/Acabado

Nickelé / Nickel plated / Niquelado

Utilisation/Use/Utilización

Boîtes aux lettres épaisseur 0 à 12mm

Letter boxes 0 to 12 mm max

Buzones 0 to 12 mm max



GARANTIE



X 2

Designation	Boite	Colis.	Prix	Sachet	Colis.	Prix	Brochable					Colis.	Prix
							France	Euro 1	Euro 2	Euro 3	Euro 4		
Batteuse avec came pour ép. maxi 12 mm	-	-	-	00917906	20	-	00117906	00193185 NS	00192185 NS	00194185	-	10	-

NS Non stocké/Non-stored/Producto no estocado - E Sur stock Europe Zone 1 et Zone 2, nous consulter pour délai d'approvisionnement - E Epuisement/Stock depletion/Agotamiento del stock

Batteuse / CAME PLATE + CAME COUDÉE

ECO



X 2



GARANTIE

Description/Description/Descripción

Corps alliage moulé. Mécanisme à paillettes 1 came plate + 1 came coudée. 2 clés nickelées. Ecrou de fixation.

Moulded alloy body. Disc tumblers mechanism. Flat cam + blended cam. 2 nickel plated keys. Fixing nut.

Cuerpo de aleacion moldeada. Mecanismo de plaquitas.

Leva plana + leva acodada. 2 llaves niqueladas. Tuerca de fijacion

Finition/Finish/Acabado

Chromé / Chrome plated / Cromado

Utilisation/Use/Utilización

Boîtes aux lettres / Letter boxes / Buzones de chapa

Designation	Boite	Colis.	Prix	Sachet	Colis.	Prix	Brochable					Colis.	Prix
							France	Euro 1	Euro 2	Euro 3	Euro 4		
Batteuse 13 mm avec cames pour ép.1 à 5 mm maxi	-	-	-	00917931	20	-	00117931	-	-	-	-	10	-
Batteuse 19 mm avec cames pour ép.1 à 13 mm maxi	-	-	-	00917932	20	-	00117932	-	-	-	-	10	-
Batteuse 33 mm avec cames pour ép.1 à 28 mm maxi	-	-	-	00917933	20	-	00117933	-	-	-	-	10	-

Batteuse / CAME PLATE + CAME COUDÉE

ECO



X 2



GARANTIE

Description/Description/Descripción

Corps alliage moulé. Mécanisme à paillettes. 1 came plate + 1 came coudée. 2 clés nickelées. Ecrou de fixation

Moulded alloy body. Disc tumblers mechanism. Flat cam + blended cam. 2 nickel plated keys. Fixing nut.

Cuerpo de aleacion moldeada. Mecanismo de plaquitas.

Leva plana + leva acodada. 2 llaves niqueladas. Tuerca de fijacion.

Finition/Finish/Acabado

Chromé / Chrome plated / Cromado

Utilisation/Use/Utilización

Boîtes aux lettres / Letter boxes / Buzones de chapa

Designation	Boite	Colis.	Prix	Sachet	Colis.	Prix	Brochable					Colis.	Prix
							France	Euro 1	Euro 2	Euro 3	Euro 4		
Batteuse 17,5 mm came plate + came coudée pour ép.1 à 13,5 mm maxi	-	-	-	00917936	20	-	00117936	-	-	-	-	10	-

Non stocké/Non-stored/Producto no estocado - Sur stock Europe Zone 1 et Zone 2, nous consulter pour délai d'approvisionnement - Epuement/Stock depletion/Agotamiento del stock

Batteuse / CAME COUDÉE

ECO

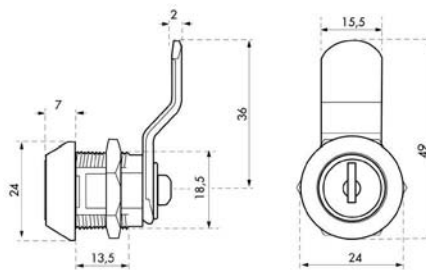

Description/Description/Descripción

Corps alliage moulé. Mécanisme à paillettes. Came coudée vers l'arrière montée à 12h. 2 clés nickelées. Ecrou et griffe de fixation

Moulded alloy body. Disc tumblers mechanism. Bended cam adjusted at 12 o'clock. 2 nickel plated keys. Nut and click.

Cuerpo de aleacion moldeada. Mecanismo de plaquitas. Leva acodada montada a 12h. 2 llaves niqueladas. Tuerca y clip de lu-1279?jacion.

Finition/Finish/Acabado

Chromé
Chrome plated
Cromado

Utilisation/Use/Utilización

Boîtes aux lettres
Letter boxes
Buzones de chapa



GARANTIE



X 2

Designation	Boîte	Colis.	Prix	Sachet	Colis.	Prix	Brochable					Colis.	Prix
							France	Euro 1	Euro 2	Euro 3	Euro 4		
Batteuse 9,7 mm came coudée pour ép.1 à 10 mm maxi	-	-	-	00917935	20	-	00117935	-	-	-	-	10	-

Batteuse / CAME COUDÉE

ECO

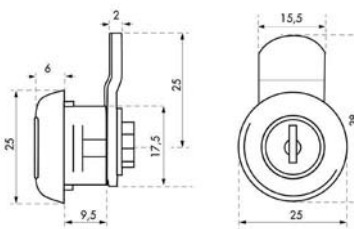

Description/Description/Descripción

Corps alliage moulé. Mécanisme à paillettes. Came coudée vers l'arrière montée à 12h. 2 clés nickelées. Griffes de fixation

Moulded alloy body. Disc Moulded alloy body. Disc tumblers mechanism. Bended cam adjusted at 12 o'clock. 2 nickel plated keys. Fixing click.

Cuerpo de aleacion moldeada. Mecanismo de plaquitas. Leva acodada montada a 12h. 2 llaves niqueladas. Clip de lu-1279?jacion.

Finition/Finish/Acabado

Nickelé
Nickel plated
Niquelado

Utilisation/Use/Utilización

Boîtes aux lettres
Letter boxes
Buzones de chapa



GARANTIE



X 2

Designation	Boîte	Colis.	Prix	Sachet	Colis.	Prix	Brochable					Colis.	Prix
							France	Euro 1	Euro 2	Euro 3	Euro 4		
Batteuse 9,7 mm came coudée pour ép.1 à 5,5 mm maxi	-	-	-	00917934	20	-	00117934	-	-	-	-	10	-

⚠ Non stocké/Non-stored/Producto no estocado - 📦 Sur stock Europe Zone 1 et Zone 2, nous consulter pour délai d'approvisionnement - 📦 Epuisement/Stock depletion/Agotamiento del stock

Batteuse / À COMBINAISON PROTECT



GARANTIE

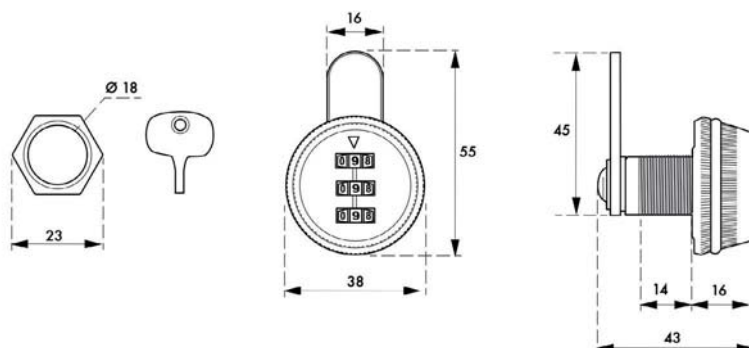

Description/Description/Descripción

Corps alliage chromé. Mécanisme à combinaison modifiable. 3 viroles. 1000 combinaisons possibles. Came plate acier. Écrou de fixation.

Chrome plated alloy body. Changeable combination mechanism. 3 dials. 1000 different combinations. Flat steel cam. Fixing nut.

Cuerpo de aleación cromada. Mecanismo de combinación cambiante. 3 virolas. 1000 combinaciones diferentes. Leva de acero plana. Tuerca de fijación.

Finition/Finish/Acabado

Chromé.

Chrome plated.

Cromado pulido.

Utilisation/Use/Utilización

Boîtes aux lettres, casiers, vestiaires, meubles

Mailboxes, lockers, cloakrooms, furniture

Buzones, taquillas, guardarropa, mobiliario

Designation	Boîte	Colis.	Prix	Sachet	Colis.	Prix	Brochable					Colis.	Prix
							France	Euro 1	Euro 2	Euro 3	Euro 4		
Batteuse à combinaison 3 viroles	-	-	-	00917937	-	-	-	-	-	-	-	-	-

⊗ Non stocké/Non-stored/Producto no estocado - ⊠ Sur stock Europe Zone 1 et Zone 2, nous consulter pour délai d'approvisionnement - ⊞ Epuisement/Stock depletion/Agotamiento del stock

Batteuse / CAME PLATE

PROTECT



GARANTIE



X 2

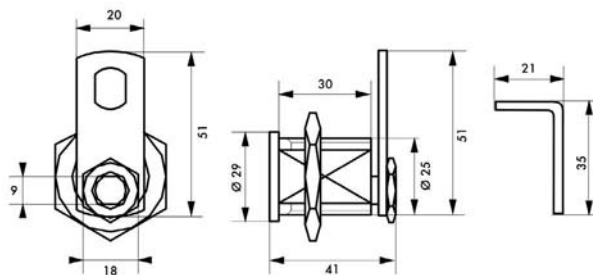

Description/Description/Descripción

Corps laiton. Mécanisme à goupilles. Ouverture par clé passe de l'agent des P.T.T. pour réf : 028299, 028301 et 128331. Pour épaisseur 23 mm maxi. 2 clés en acier nickelé. Ecrou de fixation. Came plate n°3

Brass body. Pin mechanism. Opening by the masterkey of the postal service agent. Flat came for 23 mm thickness. 2 nickel plated steel keys. Fixing nut. Came n° 3.

Cuerpo de latón. Mecanismo de pasadores. Apertura mediante llave de paso del cartero. Leva plana para 23 mm de espesor. 2 llaves de acero niquelado. Tuerca de fijación. Leva n°3.

Finition/Finish/Acabado

Chromé

Chrome plated

Latón o niquelado

Version/Option/Versión

128331 - Cames n°1 et 5, double rainurage avec fourchette. Tout laiton

128331 - Cam n°1 and 5, double grooving with ranges. All brass

128331 - Levas n° 5, doble ranurado con rango. Latón.

Utilisation/Use/Utilización

Boîte aux lettres compatible avec la distribution postale

Mailbox compatible with postal delivery

Buzón compatible con el envío postal

Batteuse / CAME PLATE

PROTECT

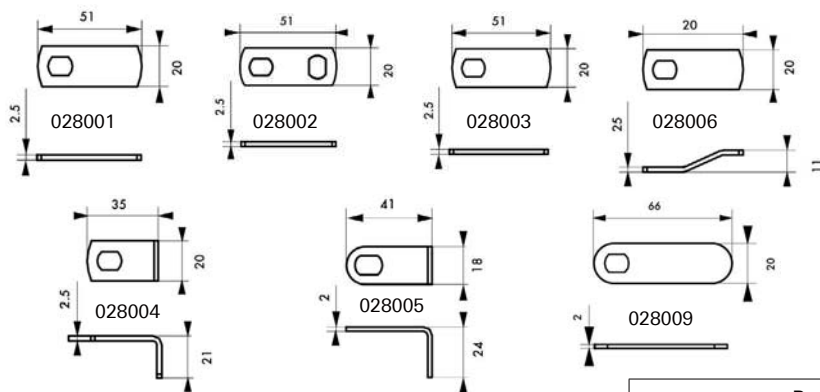

Designation	Boite	Colis.	Prix	Sachet	Colis.	Prix	Brochable					Colis.	Prix
							France	Euro 1	Euro 2	Euro 3	Euro 4		
Batteuse postale lisse 5G pour ép. maxi 1,2 mm 2 clés	00028299	10	-	-	-	-	00128299	-	-	-	-	-	-
Batteuse postale fileté pour ép. maxi 23 mm	00028301	10	-	00928301	20	-	00128301	-	-	-	-	10	-
Batt. postale fileté et clipsable pour ép. maxi 23 mm	-	-	-	00928331	20	-	00128331	-	-	-	-	10	-
Batteuse fileté laiton chromé 5G pour ép.maxi 23mm 3 clés - spécial marine	00028313	10	-	-	-	-	-	-	-	-	-	-	-
Batteuse fileté tout laiton 5G pour ép.maxi 23mm 3 clés - spécial marine	00028302	10	-	-	-	-	00128302	-	-	-	-	10	-
Batteuse fileté tout laiton 6G pour ép.maxi 23mm 3 clés - spécial marine	00028322 <small>NS</small>	10	-	-	-	-	-	-	-	-	-	-	-
Batteuse fileté HG5 laiton chromé 3 clés	00028312	10	-	-	-	-	-	-	-	-	-	-	-
Batteuse fileté HG6 laiton chromé 3 clés	00028315 <small>NS</small>	10	-	-	-	-	-	-	-	-	-	-	-
Batteuse fileté ADRIATIC laiton chromé 3 clés	00049300 <small>NS</small>	10	-	-	-	-	-	-	-	-	-	-	-
Batteuse fileté TRANSIT 2 laiton chromé 3 clés	00028412	10	-	-	-	-	-	-	-	-	-	-	-
Batteuse fileté TRANSIT Evolution laiton chromé 3 clés	00028512 <small>NS</small>	10	-	-	-	-	-	-	-	-	-	-	-
Came batteuse AC Z/B n°1	00028001	10	-	-	-	-	-	-	-	-	-	-	-
Came batteuse AC Z/B n°2	00028010 <small>NS</small>	10	-	-	-	-	-	-	-	-	-	-	-
Came batteuse AC Z/B n°3	00028002	10	-	-	-	-	-	-	-	-	-	-	-
Came batteuse laiton n°1	00028003 <small>NS</small>	10	-	-	-	-	-	-	-	-	-	-	-
Came batteuse AC Z/B n°4	00028006	10	-	-	-	-	-	-	-	-	-	-	-
Came batteuse AC Z/B n°5	00028004	10	-	-	-	-	-	-	-	-	-	-	-
Came batteuse AC Z/B n°6	00028005	10	-	-	-	-	-	-	-	-	-	-	-
Came batteuse AC Z/B n°8	00028009	10	-	-	-	-	-	-	-	-	-	-	-
Jeu de 4 cames (n°3 - 5 - 6 - 8) batteuse PTT	-	-	-	-	-	-	00128000	-	-	-	-	10	-

NS Non stocké/Non-stored/Productos no estocados - ■ Sur stock Europe Zone 1 et Zone 2, nous consulter pour délai d'approvisionnement - E Epuement/Stock depletion/Agotamiento del stock



Batteuse / SURVEYOR / COBRA M RESIST



GARANTIE



X 4

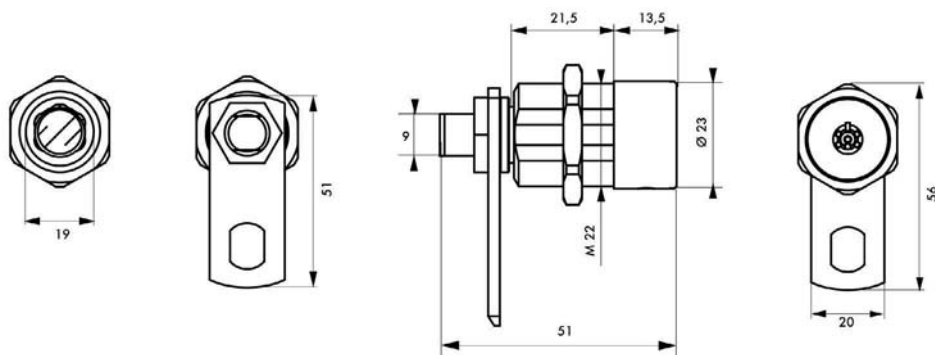

Description/Description/Descripción

Corps laiton. Mécanisme à pompes. Came plate. Clés à pompes. Ecrou de fixation.

Brass body. Pump mechanism. Flat cam. Pump keys. Fixing nut.

Cuerpo de latón. Mecanismo de bombas. Leva plana. Llaves de bombas. Tuerca de fijación.

Finition/Finish/Acabado

Chromé

Chrome plated

Latón o niquelado

Utilisation/Use/Utilización

Boîtes aux lettres

Letter boxes

Buzones de chapa

Designation	Boite	Colis.	Prix	Sachet	Colis.	Prix	Brochable					Colis.	Prix
							France	Euro 1	Euro 2	Euro 3	Euro 4		
Batteuse fileté SURVEYOR chromé avec came 4 clés	00023741 NS	10	-	-	-	-	-	-	-	-	-	-	-
Batteuse fileté COBRA M chromé avec came 3 clés	00094308 NS	10	-	-	-	-	-	-	-	-	-	-	-

NS Non stocké/Non-stored/Producto no estocado - ☑ Sur stock Europe Zone 1 et Zone 2, nous consulter pour délai d'approvisionnement - ☒ Epuisement/Stock depletion/Agotamiento del stock

Batteuse / BARRILLET CONTACTEUR

RESIST

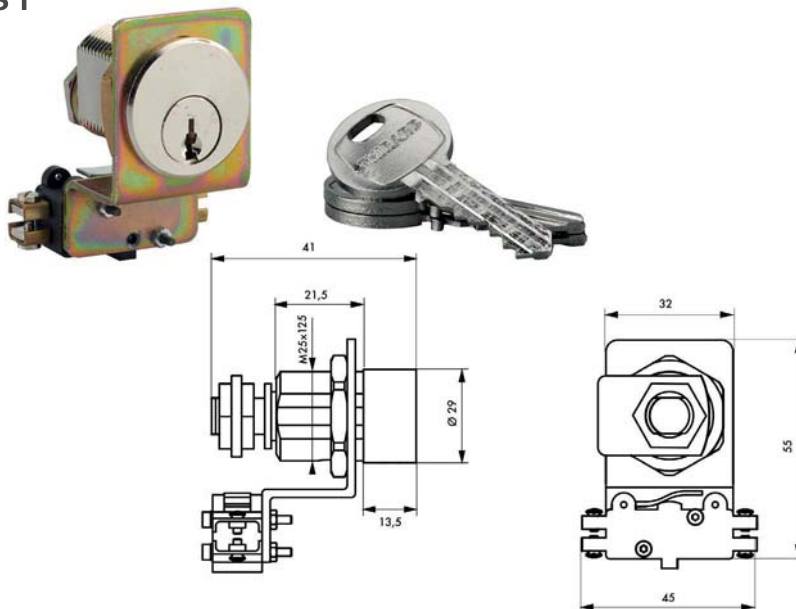

GARANTIE



X 3

Description/Description/Descripción

Contacteur à commande par clé. Corps laiton.
Mécanisme à goupilles. Inverseur à 4 bornes.
Minirupteur avec connexions vissées montage possible sur organigramme. 3 clés en acier nickelé.

Key-controlled contactor. Brass body. Pin mechanism. Electric system with 4 clamps with screws. Can be included in a master-key system. 3 nickel plated keys.
Contactor de mando mediante llave. Cuerpo de latón. Mecanismo de pasadores. Inversor de 4 bornes. Minirruptor con conexiones atornilladas con posible montaje en organigrama. 3 llaves de acero niquelado

Finition/Finish/Acabado

Chromé
Chrome plated or polished brass
Cromado o latón pulido

Version/Option/Versión

Avec cylindre 5 ou 6 goupilles HG - ADRIATIC - COBRA M - TRANSIT 2 - TRANSIT évolution - ATLANTIC - ATLANTIC M. Possibilité d'ouverture sur passe PTT et EDF

With cylinder 5 or 6 pins HG - ADRIATIC - COBRA M - TRANSIT 2 - TRANSIT évolution - ATLANTIC - ATLANTIC M. Opening on master key system of French Post
Con cilindro 5 ó 6 pasadores HG - ADRIATIC - COBRA M - TRANSIT 2 - TRANSIT ÉVOLUTION - ATLANTIC - ATLANTIC M. Con posibilidad de apertura para el paso del cartero y del encargado de la lectura del contador de electricidad

Utilisation/Use/Utilización

Pour toutes commandes de serrure ou gâche électrique, dispositif de sécurité, etc...
For all controls of locks or electric strikes, security devices, etc...
Para todos los controles de cerraduras o cerraderos eléctricos, dispositivos de seguridad, etc.

Designation	Boite	Colis.	Prix	Sachet	Colis.	Prix	Brochable					Colis.	Prix
							France	Euro 1	Euro 2	Euro 3	Euro 4		
Barillet contacteur fileté HG5 3 clés	00094300 <small>NS</small>	1	-	-	-	-	-	-	-	-	-	-	-
Barillet contacteur fileté HG6 3 clés	00094302 <small>NS</small>	1	-	-	-	-	-	-	-	-	-	-	-
Barillet contacteur fileté ADRIATIC 3 clés	00049500 <small>NS</small>	1	-	-	-	-	-	-	-	-	-	-	-
Barillet contacteur fileté COBRA M 3 clés	00094307 <small>NS</small>	1	-	-	-	-	-	-	-	-	-	-	-
Barillet contacteur fileté TRANSIT 2 4 clés	00094303	1	-	-	-	-	-	-	-	-	-	-	-
Barillet contacteur fileté TRANSIT Evolution 4 clés	00094304 <small>NS</small>	1	-	-	-	-	-	-	-	-	-	-	-
Barillet contacteur fileté ATLANTIC 4 clés	00094305 <small>NS</small>	1	-	-	-	-	-	-	-	-	-	-	-
Barillet contacteur fileté ATLANTIC M 4 clés	00094306 <small>NS</small>	1	-	-	-	-	-	-	-	-	-	-	-

NS Non stocké/Non-stored/Producto no estocado - ■ Sur stock Europe Zone 1 et Zone 2, nous consulter pour délai d'approvisionnement - E Epuisement/Stock depletion/Agotamiento del stock

Contacteur à clé / A APPLIQUER / A ENCASTRER RESIST



GARANTIE

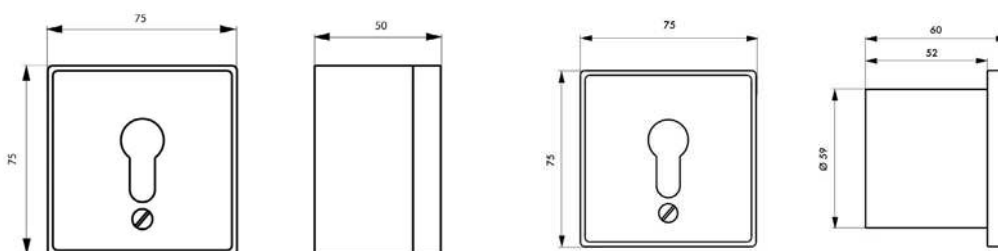
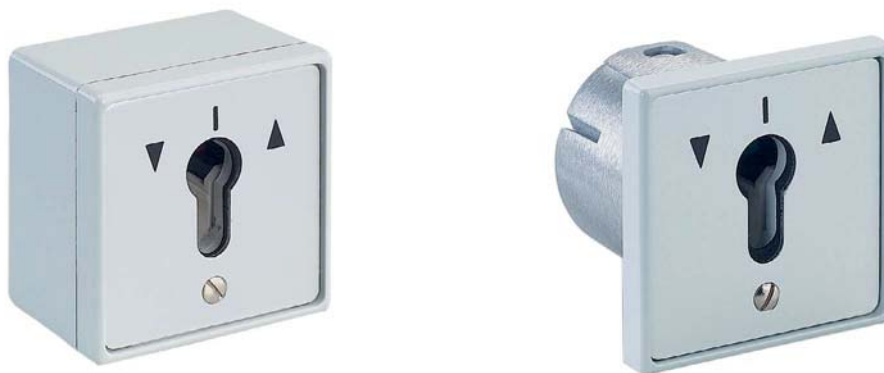

Description/Description/Descripción

Contacteur à clé pour cylindre profilé. Système anti-effraction. Livré sans cylindre 30 x 10 mm.
Key contactor for profile cylinder. Tamper-proof system.
Supplied without cylinder 30 x 10 mm.

Contactor de llave para cilindro perfilado. Sistema antifractura. Entregado sin cilindro 30 x 10 mm.

Finition/Finish/Acabado

Laqué gris
Grey varnished
lacado gris

Utilisation/Use/Utilización

Sécurisation de systèmes de commande
Protection of control systems
Seguridad de los sistemas de mando

Designation	Boite	Colis.	Prix	Sachet	Colis.	Prix	Brochable					Colis.	Prix
							France	Euro 1	Euro 2	Euro 3	Euro 4		
Contacteur à clé en applique (sans cylindre)	00012220	1	-	-	-	-	-	-	-	-	-	-	-
Contacteur à clé à encastrer (sans cylindre)	00012221	1	-	-	-	-	-	-	-	-	-	-	-

⚠ Non stocké/Non-stored/Producto no estocado - 📦 Sur stock Europe Zone 1 et Zone 2, nous consulter pour délai d'approvisionnement - 📦 Epuisement/Stock depletion/Agotamiento del stock

Contacteur à clé triangle / À APPLIQUER

PROTECT



GARANTIE

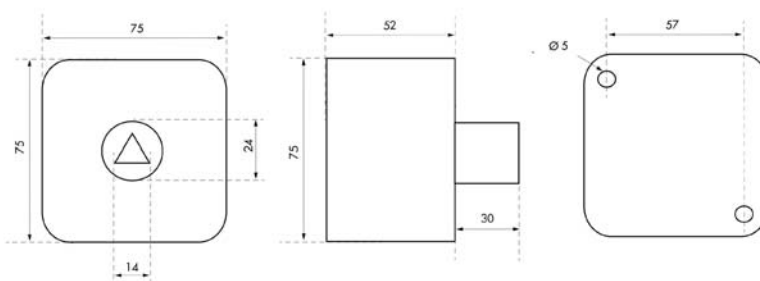

Description/Description/Descripción

Corps alliage. Plastron acier. Triangle mâle laiton 14mm.
 Moulded alloy body. Steel plate. Brass triangle 14mm.
 Cuerpo de aleación. Placa de acero. Triángulo 14mm de latón.

Finition/Finish/Acabado

Epoxy Rouge.
 Red epoxy.
 Epoxi rojo.

Utilisation/Use/Utilización

Ouverture par clé triangle pompier.
 Opening by firefighter triangle key.
 Apertura por llave triangular de bombero.

Designation	Boîte	Colis.	Prix	Sachet	Colis.	Prix	Brochable					Colis.	Prix
							France	Euro 1	Euro 2	Euro 3	Euro 4		
Contacteur à clé pompier en applique triangle 14mm	00012222	1	-	-	-	-	-	-	-	-	-	-	-

Non stocké/Non-stored/Producto no estocado - Sur stock Europe Zone 1 et Zone 2, nous consulter pour délai d'approvisionnement - Epuisement/Stock depletion/Agotamiento del stock



THIRARD

MONOMAX



MADE
IN
FRANCE



Serrures à encastrer

PORTE D'ENTRÉE



594 PORTE INTÉRIEURE



664
701

PORTE SALLE DE
BAINS



679 PORTE BATTANTE



720

PORTE
COULISSANTE



723 PORTAIL

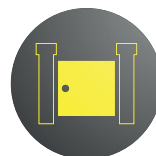

728

INDUSTRIE



730 ACCESSOIRES

734

FERCO BY THIRARD



740 SUPPLÉMENTS
POUR SERRURES À ENCASTRER

764



*Sommaire détaillé par produit
page suivante*



Serrures à encastrer

ECO
PROTECT
RESIST

PORTE D'ENTRÉE



Axe à 40 mm 3 gorges	594
Axe à 40 mm à clé double panneton	595
Axe à 40 mm à clé double panneton	596
Axe à 35 mm à cylindre	597
Axe à 40mm à cylindre, 1 tour	599
Axe à 40mm à cylindre, 1 tour	600
Axe à 40mm à cylindre, 1 tour	601
Axe à 40mm à cylindre, 1 tour	603
Axe à 40mm à cylindre, 2 tours	604
Axe à 40mm à cylindre	605
Axe à 40mm à cylindre	605
Axe à 40mm à cylindre	606
Axe à 40mm à cylindre	606
Axe à 40 mm MONOMAX à cylindre, tête affleurante	607
Axe à 40 mm MONOMAX NF à cylindre	609
Axe à 45 mm à cylindre	610
Axe à 45 mm à cylindre	610
Axe à 45 mm à cylindre	611
Axe à 45 mm à cylindre	611
Axe à 45 mm à cylindre	612
Axe à 45 mm MONOMAX NF à cylindre	612
Axe à 50 mm à cylindre, 1 tour	613
Axe à 50 mm à cylindre, 2 tours	615
Axe à 50 mm à cylindre, 2 tours	616
Axe à 50 mm magnétique, à cylindre	616
Axe à 50 mm à cylindre	617
Axe à 50 mm à cylindre	618
Axe à 50 mm à cylindre	618
Axe à 50 mm à cylindre	619



Axe à 50 mm à cylindre	619
Axe à 50 mm à cylindre	620
Axe à 50 mm à cylindre	620
Axe à 50 mm à cylindre	621
Axe à 50 mm MONOMAX à cylindre, tête affleurante	623
Axe à 50 mm MONOMAX NF à cylindre, 2 tours	625
Axe à 50 mm UNIMAX CE NFQC à cylindre	627
Axe à 50 mm UNIMAX CE NFQC A2P* à cylindre	629
Multipoints TRIMAX NFQC	630
Multipoints TRIMAX NFQC A2P*	632
Axe à 50 mm à cylindre, 2 tours	635
Axe à 55 mm «ALSACE» à cylindre	636
Axe à 55 mm à cylindre	637
Axe à 60 mm à cylindre	638
Axe à 60 mm à cylindre	639
Axe à 60 mm à cylindre	639
Axe à 60 mm à cylindre	640
Axe à 60 mm à cylindre	641
Axe à 67 mm à cylindre	641
Axe à 67 mm à cylindre	642
Axe à 67 mm à cylindre	642
Axe à 70 mm à cylindre	643
Axe à 70 mm à cylindre	644
Axe à 80 mm à cylindre	645
Axe à 15 mm à cylindre	646
Axe 17, 27, 37 mm à cylindre	646
Entraxe 70 mm à cylindre	647
Entraxe 70 mm à cylindre	648
Entraxe 70 mm à cylindre	649
Entraxe 70 mm à cylindre	650
Entraxe 70 mm à cylindre	651

Entraxe 85 mm à cylindre	652
Entraxe 85 mm à cylindre	653
Entraxe 85 mm à cylindre	654
Entraxe 85 mm à cylindre	655
Entraxe 92 mm à cylindre	656
Entraxe 92 mm à cylindre	657
Entraxe 92 mm à cylindre	658
Entraxe 92 mm à cylindre	659
Entraxe 92 mm à cylindre	660
Entraxe 92 mm à cylindre	661
Entraxe 70 mm à crochet, à cylindre	662
Entraxe 85 mm à crochet, à cylindre	662
Entraxe 104 mm à mentonnet, à cylindre	663

























PORTE INTÉRIEURE



























Axe à 40 mm Bec de cane	664
Axe à 40 mm Bec de cane	665
Axe à 40 mm magnétique, bec de cane	665
Axe à 40 mm Bec de cane	666
Axe à 40 mm Bec de cane	667
Axe à 40 mm NF Bec de cane	668
Axe à 40 mm NF Bec de cane	669
Axe à 50 mm Bec de cane	670
Axe à 50 mm Bec de cane	671
Axe à 50 mm Bec de cane	672
Axe à 50 mm magnétique, bec de cane	672
Axe à 50 mm Bec de cane	673
Axe à 50 mm NF Bec de cane	674
Axe à 50 mm CE NFQC bec de cane	675
Axe à 60 mm Bec de cane	676

Axe à 70 mm Bec de cane		677
Axe à 80 mm Bec de cane		678



PORTE SALLE DE BAINS

Axe à 40 mm à condamnation		679
Axe à 40 mm à condamnation		680
Axe à 40 mm / magnétique, à condamnation		680
Axe à 40 mm à condamnation		681
Axe à 40 mm à condamnation		683
Axe à 40 mm à condamnation		684
Axe à 40 mm NF à condamnation		685
Axe à 40 mm MONOMAX NF à condamnation		686
Axe à 45 mm à condamnation		688
Axe à 45 mm à condamnation		688
Axe à 50 mm à condamnation		689
Axe à 50 mm à condamnation		690
Axe à 50 mm à condamnation		690
Axe à 50 mm à condamnation		691
Axe à 50 mm magnétique, à condamnation		691
Axe à 50 mm à condamnation		692
Axe à 50 mm à condamnation		693
Axe à 50 mm à condamnation		693
Axe à 50 mm MONOMAX NF à condamnation		694
Axe à 50 mm UNIMAX CE NFQC à condamnation		695
Axe à 55 mm «ALSACE» à condamnation		696
Axe à 60 mm à condamnation		697
Axe à 70 mm à condamnation		698
Axe à 80 mm à condamnation		699





PORTE INTÉRIURE

Axe à 40 mm Pêne dormant 1/2 tour		701
Axe à 40 mm Pêne dormant 1/2 tour		702
Axe à 40 mm Pêne dormant 1/2 tour		702
Axe à 40 mm Pêne dormant 1/2 tour		703
Axe à 40 mm Pêne dormant 1/2 tour		704
Axe à 40 mm magnétique, Pêne dormant 1/2 tour		704
Axe à 40 mm Pêne dormant 1/2 tour		705
Axe à 40 mm Pêne dormant 1/2 tour		707
Axe à 40 mm Pêne dormant 1/2 tour		708
Axe à 40 mm Pêne dormant 1/2 tour		709
Axe à 43 mm Pêne dormant 1/2 tour		710
Axe à 45 mm Pêne dormant 1/2 tour		710
Axe à 45 mm Pêne dormant 1/2 tour		711
Axe à 45 mm Pêne dormant 1/2 tour		712
Axe à 45 mm Pêne dormant 1/2 tour		712
Axe à 50 mm Pêne dormant 1/2 tour		713
Axe à 50 mm Pêne dormant 1/2 tour		714
Axe à 50 mm Pêne dormant 1/2 tour		714
Axe à 50 mm Pêne dormant 1/2 tour		715
Axe à 50 mm magnétique, Pêne dormant 1/2 tour		715
Axe à 50 mm Pêne dormant 1/2 tour		716
Axe à 50 mm Pêne dormant 1/2 tour		717
Axe à 55 mm «ALSACE» pêne dormant 1/2 tour		718
Axe à 55 mm Pêne dormant 1/2 tour		719



PORTE BATTANTE

Axe à 22 mm à rouleau		720
Axe à 50 mm à rouleau		721
A rouleau		722





PORTE COULISSANTE

Axe à 40 mm à mentonnet		723
Axe à 40 mm Galandage		724
Axe à 50 mm Galandage		725
Axe à 50 mm Galandage		726
Axe à 50 mm à mentonnet		727







PORTAIL

Entraxe 70 mm pour portail		728
Entraxe 72 mm pour portail		729

INDUSTRIE

Axe à 40 mm fouillot 6x9mm		730
Axe à 40 mm Pêne dormant seul		731
Axe à 50 mm UNIMAX NF Pêne dormant seul		732
Axe à 65 mm chaufferie		733

ACCESSOIRES

Gâches serrure à encastrer		734
Clé de blocage pour serrure à encastrer		737
Clé Multifonction		737
Adaptateur pour serrure à encastrer		738
Adaptateur pour serrure à encastrer		738
Axe à 40 / 50 mm / Ferrures de dépannage		739

Serrures  by  740

Suppléments pour serrure à encastrer 764

Axe à 40 mm / 3 GORGES

PROTECT

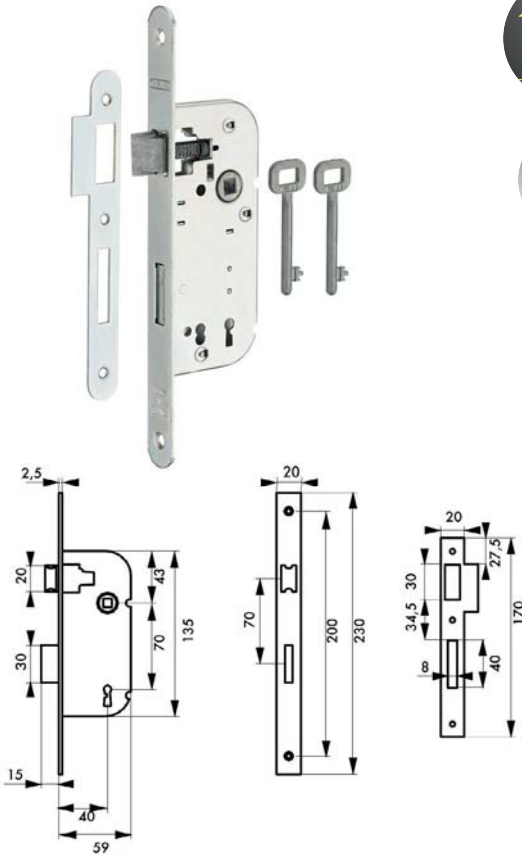

GARANTIE



X 2

Description/Description/Descripción

Coffre acier embouti. Tête acier. Demi-tour alliage réversible sans démontage du coffre. Pêne alliage. Gâche plate acier. Mécanisme à 3 gorges, 2 tours. Carré 7 mm, entr'axe 70 mm. 2 clés. 48 variures.

Stamped steel case - Steel forend. Reversible alloy latch without removing the case. Alloy bolt. Steel flat striker. 3 lever mechanism, double deadbolt throw. Square 7 mm. 2 keys - 48 different keys.

Caja de acero embutido. Cabeza de acero. Media vuelta de aleación reversible sin desmontar la caja. Pestillo de aleación. Cerradero plano de acero. Mecanismo de 3 canilllos, 2 vueltas. Cuadrado 7 mm. 2 llaves - 48 perfiles de llave.

Finition/Finish/Acabado

Epoxy blanc (V) - Zingué (Z).
White epoxy (V) - Zinc plated (Z)
Epoxi blanco (V) - Cincado (Z)

Version/Option/Versión

Tête bouts carrés (BC) Tête bouts ronds (BR)
Square (BC) Round (BR) ended forend
Cabeza de extremos cuadrados (BC) Cabeza de extremos redondos (BR)

Designation	Boite	Colis.	Prix	Sachet	Colis.	Prix	Brochable					Colis.	Prix
							France	Euro 1	Euro 2	Euro 3	Euro 4		
Serrure axe 40mm 3 gorges V/BC 2 clés	00000103	10	-	-	-	-	00400103	-	-	-	-	10	-
Serrure axe 40mm 3 gorges V/BR 2 clés	00001103	10	-	00901103	30	-	00401103	-	-	-	-	10	-
Serrure axe 40mm 3 gorges Z/BC 2 clés	00010103	10	-	-	-	-	-	-	-	-	-	-	-
Serrure axe 40mm 3 gorges Z/BR 2 clés	00011103	10	-	-	-	-	00411103	-	-	-	-	10	-
Tarif conditionnement non décollable													
Serrure axe 40mm 3 gorges réversible V/BC 2 clés (par 50 pièces non décollable)	00050193	50	-	-	-	-	-	-	-	-	-	-	-
Serrure axe 40mm 3 gorges réversible V/BR 2 clés (par 50 pièces non décollable)	00051193	50	-	-	-	-	-	-	-	-	-	-	-

NS Non stocké/Non-stored/Producto no estocado - E Sur stock Europe Zone 1 et Zone 2, nous consulter pour délai d'approvisionnement - E Epusement/Stock depletion/Agotamiento del stock

Axe à 40 mm / A CLE DOUBLE PANNETON RESIST



GARANTIE



X 3

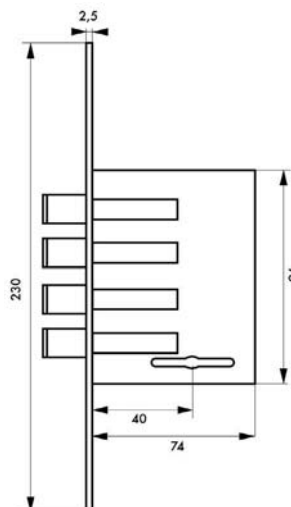

Description/Description/Descripción

Coffre acier embouti. Tête acier bouts carrés. Réversible. Pêne alliage zingué . Gâche plate acier. 3 clés
Stamped steel case. Steel forend. Reversible. Zinc plated alloy bolt. Steel flat striker. 3 keys
 Caja de acero embutido. Cabeza de acero. Reversible. Pestillo de aleación cincada . Cerradero plano de acero. 3 llaves

Finition/Finish/Acabado

Tête laitonée.
Brass plated forend.
 Cabeza de latónado.

Designation	Boite	Colis.	Prix	Sachet	Colis.	Prix	Brochable					Colis.	Prix
							France	Euro 1	Euro 2	Euro 3	Euro 4		
Serrure axe 45mm à clé double panneton 4 pènes - 3 clés	00094345	1	-	-	-	-	-	-	-	00494345	-	5	-

⚠ Non stocké/Non-stored/Producto no estocado - 📦 Sur stock Europe Zone 1 et Zone 2, nous consulter pour délai d'approvisionnement - ⚠ Epuisement/Stock depletion/Agotamiento del stock

Axe à 40 mm / A CLE DOUBLE PANNETON RESIST



GARANTIE



X 3

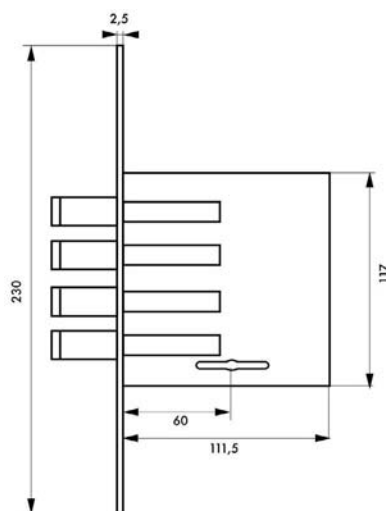

Description/Description/Descripción

Coffre acier embouti. Tête acier bouts carrés. Réversible. Pêne alliage zingué . Gâche plate acier. 3 clés
Stamped steel case. Steel forend. Reversible. Zinc plated alloy bolt. Steel flat striker. 3 keys
 Caja de acero embutido. Cabeza de acero. Reversible. Pestillo de aleación cincada . Cerradero plano de acero. 3 llaves

Finition/Finish/Acabado

Tête laitonée.
Brass plated forend.
 Cabeza de latónado.

Designation	Boite	Colis.	Prix	Sachet	Colis.	Prix	Brochable					Colis.	Prix
							France	Euro 1	Euro 2	Euro 3	Euro 4		
Serrure axe 60mm à clé double panneton 4 pènes - 3 clés	00094346	1	-	-	-	-	-	-	-	00494346	-	5	-

⚠ Non stocké/Non-stored/Producto no estocado - 📦 Sur stock Europe Zone 1 et Zone 2, nous consulter pour délai d'approvisionnement - 🇪🇺 Epuisement/Stock depletion/Agotamiento del stock

Axe à 35 mm / A CYLINDRE RESIST



GARANTIE

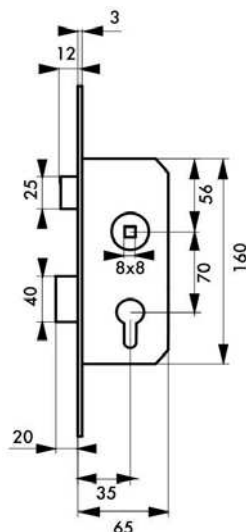

Description/Description/Descripción

Coffre acier embouti. Têtière acier bouts Carrés. Demi-tour réversible sans démontage du coffre. Pêne alliage zingué. Gâche plate acier. Carré 8 mm, entr'axe 70 mm. Rappel du 1/2 tour par la clé.

Stamped steel case. Steel forend. Reversible latch without removing the case. Zinc plated alloy bolt. Steel flat striker. Square 8 mm. Drawback of the latch by the key.

Caja de acero embutido. Cabeza de acero. Media vuelta reversible sin desmontar la caja. Pestillo de aleación cincada. Cerradero plano de acero. Cuadrado 8 mm. Reposición de la media vuelta con llave

Finition/Finish/Acabado

Têtière laitonée. Têtière nickelée.
Brass plated forend. Nickel forend.
Cabeza de latónado. Cabeza niquelado

Designation	Boite	Colis.	Prix	Sachet	Colis.	Prix	Brochable					Colis.	Prix
							France	Euro 1	Euro 2	Euro 3	Euro 4		
Boîtier serrure axe 35mm à cylindre têteière laitonée	00094511	1	-	-	-	-	-	-	-	00494511	-	5	-
Boîtier serrure axe 35mm à cylindre têteière nickelée	00094526	1	-	-	-	-	-	-	-	00494526	-	5	-

⚠ Non stocké/Non-stored/Producto no estocado - 📄 Sur stock Europe Zone 1 et Zone 2, nous consulter pour délai d'approvisionnement - ⚠ Epuisement/Stock depletion/Agotamiento del stock

Axe à 40mm / A CYLINDRE, 1 TOUR

PROTECT



GARANTIE



X 3



Description/Description/Descripción

Coffre acier embouti. Tête acier. Demi-tour alliage réversible sans démontage du coffre. Pêne alliage. Gâche plate acier. Mécanisme à 1 tour. Carré 7 mm, entr'axe 70 mm. Sans rappel du 1/2 tour par la clé.

Stamped steel case. Steel forend. Reversible alloy latch without removing the case. Alloy bolt. Steel flat striker. One deadbolt throw. Square 7 mm. Without drawback of the latch by the key.

Caja de acero embutido. Cabeza de acero. Media vuelta de aleación reversible sin desmontar la caja. Pestillo de aleación. Cerradero plano de acero. Mecanismo de 1 vuelta. Cuadrado 7 mm. No reposición de la media vuelta con llave.

Finition/Finish/Acabado

Epoxy blanc(V) - Zingué (Z)

White epoxy (V) - Zinc plated (Z)

Epoxi blanco (V) - Cincado (Z)

Version/Option/Versión

Tête acier bouts carrés (BC). Tête acier bouts ronds (BR). Avec cylindre profilé laiton, 30 x 30 mm, 3 clés.

Square (BC). Round (BR) ended forend. With brass profile cylinder, 30 x 30 mm, 3 keys.

Cabeza de extremos cuadrados (BC). Cabeza de extremos redondos (BR). Con cilindro perfilado de latón, 30 x 30 mm, 3 llaves.

Utilisation/Use/Utilización

Porte < 40 kg, (NON GARANTIE EN CAS DE CONTRE BEQUILLAGE).

Door < 40 kg

Puerta < 40 kg

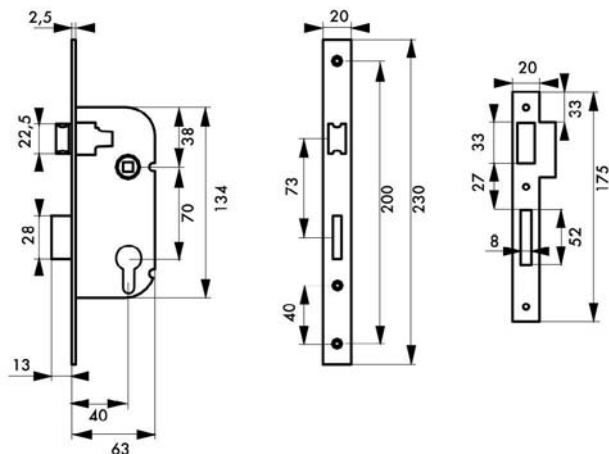

Designation	Boite	Colis.	Prix	Sachet	Colis.	Prix	Brochable					Colis.	Prix
							France	Euro 1	Euro 2	Euro 3	Euro 4		
Serrure axe 40mm à cylindre profilé V/BC 3 clés	-	-	-	-	-	-	00400104	-	-	-	-	10	-
Serrure axe 40mm à cylindre profilé V/BR 3 clés	-	-	-	-	-	-	00401104	-	-	-	-	10	-
Serrure axe 40mm à cylindre profilé Z/BR 3 clés	-	-	-	-	-	-	00411104	-	-	-	-	10	-
Boîtier serrure axe 40mm à cylindre V/BC	-	-	-	-	-	-	00400106	-	-	-	-	10	-
Boîtier serrure axe 40mm à cylindre V/BR	-	-	-	00901106	30	-	00401106	-	-	-	-	10	-
Boîtier serrure axe 40mm à cylindre Z/BR	-	-	-	-	-	-	00411106	-	-	-	-	10	-

Tarif conditionnement non décolisable

Boîtier serrure Eco+ axe à 40mm V/BR sans gâche droite (par 50 pièces non décolisable)	00081176	50	-	-	-	-	-	-	-	-	-	-	-
Boîtier serrure Eco+ axe à 40mm V/BR sans gâche gauche (par 50 pièces non décolisable)	00081186	50	-	-	-	-	-	-	-	-	-	-	-
Boîtier serrure Eco+ axe à 40mm V/BR avec rappel du 1/2 tour par la clé (par 50 pièces)	00081166	50	-	-	-	-	-	-	-	-	-	-	-
Gâche type cylindre Eco+ BR (par 50 pièces)	00081003	50	-	-	-	-	-	-	-	-	-	-	-

Tarif garniture

Garniture serrure Eco+ axe 40mm à cylindre profilé V/BR 3 clés + ensemble ARES	00022165	50	-	00922165	50	-	-	-	-	-	-	-	-
Garniture serrure Eco+ axe 40mm à cylindre profilé V/BR 3 clés + ensemble LETO	00022175	50	-	00922175	50	-	-	-	-	-	-	-	-
Garniture serrure Eco+ axe 40mm à cylindre profilé V/BR 3 clés + ensemble VESTA	00022185	50	-	00922185	50	-	-	-	-	-	-	-	-
Garniture serrure Eco+ axe 40mm à cylindre profilé V/BR 3 clés + ensemble DIONYSOS	00022195	50	-	00922195	50	-	-	-	-	-	-	-	-

☐ Non stocké/Non-stored/Productos no estocados - ☑ Sur stock Europe Zone 1 et Zone 2, nous consulter pour délai d'approvisionnement - ☒ Epuement/Stock depletion/Agotamiento del stock

Axe à 40mm / A CYLINDRE, 1 TOUR

PROTECT



GARANTIE

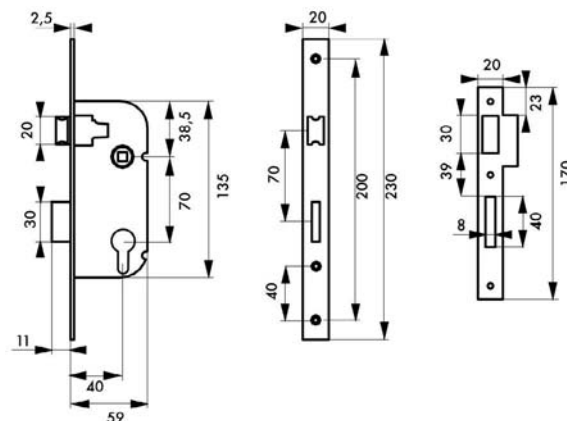

Description/Description/Descripción

Coffre acier embouti. Têtière inox. Demi-tour alliage réversible sans démontage du coffre. Pêne alliage. Gâche plate inox. Mécanisme à 1 tour. Carré 7 mm, entr'axe 70 mm. Sans rappel du 1/2 tour par la clé.

Stamped steel case. Stainless steel forend. Reversible alloy latch without removing the case. Alloy bolt. Stainless steel flat striker. One deadbolt throw. Square 7 mm. Without drawback of the latch by the key.

Caja de acero embutido. Cabeza de acero inoxidable. Media vuelta de aleación reversible sin desmontar la caja.

Pestillo de aleación. Cerradero plano de acero inoxidable. Mecanismo de 1 vuelta. Cuadrado 7 mm. No reposición de la media vuelta con llave.

Finition/Finish/Acabado

Coffre zingué / Têtière inox

Zinc plated case / Stainless steel forend

Caja cincado / Cabeza de acero inoxidable

Designation	Boite	Colis.	Prix	Sachet	Colis.	Prix	Brochable					Colis.	Prix
							France	Euro 1	Euro 2	Euro 3	Euro 4		
Boîtier serrure axe à 40mm à cylindre BR tète inox avec gâche	-	-	-	00982116	10	-	00482116	-	-	-	-	5	-
Tarif conditionnement non décollable													
Boîtier serrure axe à 40mm à cylindre BR tète inox sans gâche (par 50 pièces non décollable)	00082116	50	-	-	-	-	-	-	-	-	-	-	-
Gâche type cylindre inox BR (par 50 pièces)	00082001	50	-	-	-	-	-	-	-	-	-	-	-

⚠ Non stocké/Non-stored/Producto no estocado - 📦 Sur stock Europe Zone 1 et Zone 2, nous consulter pour délai d'approvisionnement - 📦 Epuisement/Stock depletion/Agotamiento del stock

Axe à 40mm / A CYLINDRE, 1 TOUR

ECO



GARANTIE

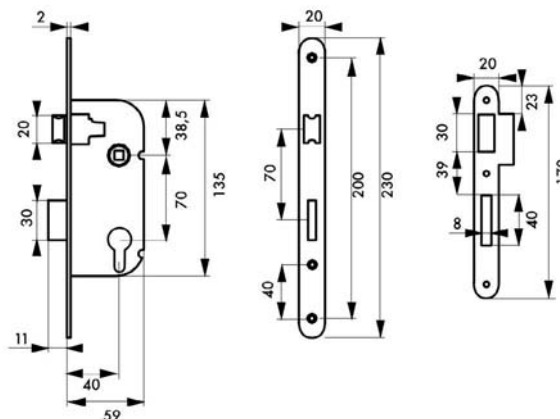

Description/Description/Descripción

Coffre acier embouti. Têtière acier bouts ronds ép.2mm. Demi-tour nylon réversible sans démontage du coffre. Pêne dormant acier. Gâche plate acier. Mécanisme à 1 tour. Carré nylon 7 mm, entraxe 70 mm. Sans rappel du 1/2 tour par la clé.

Stamped steel case. Steel forend. Reversible nylon latch without removing the case. Steel bolt. Steel at striker. One deadbolt throw. Nylon square 7 mm. Without drawback of the latch by the key.

Caja de acero embutido. Cabeza de acero de 2mm de espesor. Media vuelta de nylon reversible sin desmontar la caja. Pestillo de acero. Cerradero plano de acero. Mecanismo de 1 vuelta. Cuadrado de nylon 7 mm. No reposición de la media vuelta con llave.

Finition/Finish/Acabado

Epoxy blanc.
White epoxy.
Epoxi blanco.



Designation	Boite	Colis.	Prix	Sachet	Colis.	Prix	Brochable					Colis.	Prix
							France	Euro 1	Euro 2	Euro 3	Euro 4		
Tarif conditionnement non décollable													
Boîtier serrure Eco axe à 40mm à cylindre V/BR ((par 50 pièces non décollable)	00053196	50	-	-	-	-	-	-	-	-	-	-	-

Non stocké/Non-stored/Producto no estocado - Sur stock Europe Zone 1 et Zone 2, nous consulter pour délai d'approvisionnement - Epuisement/Stock depletion/Agotamiento del stock

Axe à 40mm / A CYLINDRE, 1 TOUR

PROTECT



GARANTIE



X 3



Description/Description/Descripción

Coffre acier embouti. Têtière acier. Demi-tour alliage réversible sans démontage du coffre. Pêne alliage. Gâche plate acier. Mécanisme à 1 tour. Carré 7 mm, entr'axe 70 mm. Sans rappel du 1/2 tour par la clé.

Stamped steel case. Steel forend. Reversible alloy latch without removing the case. Alloy bolt. Steel flat striker. One deadbolt throw. Square 7 mm. Without drawback of the latch by the key.

Caja de acero embutido. Cabeza de acero. Media vuelta de aleación reversible sin desmontar la caja. Pestillo de aleación. Cerradero plano de acero. Mecanismo de 1 vuelta. Cuadrado 7. No reposición de la media vuelta con llave.

Finition/Finish/Acabado

Epoxy blanc (V) - Zingué (Z).

White epoxy (V) - Zinc plated (Z)

Epoxi blanco (V) - Cincado (Z)

Version/Option/Versión

Têtière bouts carrés (BC). Têtière bouts ronds (BR). Avec cylindre profilé laiton, 30 x 30 mm, 3 clés. Coloris bronze sous conditionnement coque.

Square (BC). Round (BR) ended forend. With brass profile cylinder, 30 x 30 mm, 3 keys.

Cabeza de extremos cuadrados (BC). Cabeza de extremos redondos (BR). Con cilindro perfilado de latón, 30 x 30 mm, 3 llaves.

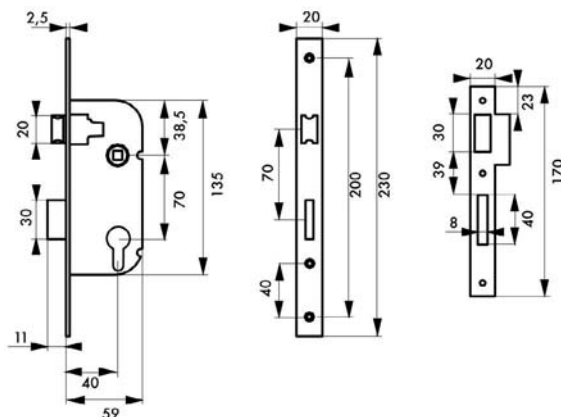

Designation	Boîte	Colis.	Prix	Sachet	Colis.	Prix	Brochable					Colis.	Prix
							France	Euro 1	Euro 2	Euro 3	Euro 4		
Serrure axe 40mm à cylindre profilé V/BC 3 clés	00000104	10	-	-	-	-	-	-	-	-	-	-	-
Serrure axe 40mm à cylindre profilé V/BR 3 clés	00001104	10	-	-	-	-	-	-	-	-	-	-	-
Serrure axe 40mm à cylindre profilé Z/BC 3 clés	00010104	10	-	-	-	-	-	-	-	-	-	-	-
Serrure axe 40mm à cylindre profilé Z/BR 3 clés	00011104	10	-	-	-	-	-	-	-	-	-	-	-
Boîtier serrure axe 40mm à cylindre V/BC	00000106	10	-	-	-	-	-	-	-	-	-	-	-
Boîtier serrure axe 40mm à cylindre V/BR	00001106	10	-	00901196	10	-	00401196	-	-	-	-	10	-
Boîtier serrure axe 40mm à cylindre Z/BC	00010106	10	-	-	-	-	-	-	-	-	-	-	-
Boîtier serrure axe 40mm à cylindre Z/BR	00011106	10	-	-	-	-	-	-	-	-	-	-	-

Tarif conditionnement non décolisable

Boîtier serrure axe 40mm à cylindre V/BC (par 50 pièces non décolisable)	00050196	50	-	-	-	-	-	-	-	-	-	-	-
Boîtier serrure axe 40mm à cylindre V/BR (par 50 pièces non décolisable)	00051196	50	-	-	-	-	-	-	-	-	-	-	-

Tarif garniture

Garniture serrure axe 40mm à cylindre profilé VBZ/BR 3 clés + ensemble ARES	00022166	50	-	-	-	-	-	-	-	-	-	-	-
Garniture serrure axe 40mm à cylindre profilé VBZ/BR 3 clés + ensemble DIONYSOS	00022176	50	-	-	-	-	-	-	-	-	-	-	-

☐ Non stocké/Non-stored/Productos no estocado - ☑ Sur stock Europe Zone 1 et Zone 2, nous consulter pour délai d'approvisionnement - ☒ Epuement/Stock depletion/Agotamiento del stock

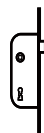

Axe à 40 mm / A CYLINDRE, 2 TOURS

PROTECT



GARANTIE



X 3

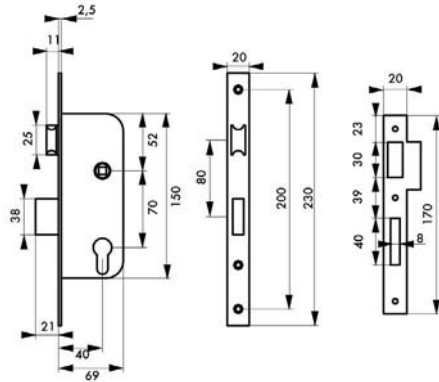

Description/Description/Descripción

Coffre acier embouti épaisseur 15 mm. Tête acier. 1/2 tour zamak réversible sans démontage du coffre. Pêne laiton. Gâche plate acier zingué. Mécanisme à 2 tours. Rappel du 1/2 tour par la clé. Carré 7 mm, entr'axe 70 mm

Stamped steel case thickness 15 mm. Steel forend. Zamak bolt and latch. Reversible without removing the case. Steel flat striker. Double deadbolt throw. Draw back of the latch by key. Square 7 mm.

Caja de acero embutido espesor 15 mm. Cabeza de acero. Pestillo, media vuelta de zamak. Reversible sin desmontar la caja. Cerradero plano de acero. Mecanismo de 2 vueltas. Reposición de la media vuelta. con la llave. Cuadrado 7 mm.

Finition/Finish/Acabado

Epoxy noir. Zingué (Z).
Black epoxy. Zinc plated (Z).
Epoxi negro. Cincado (Z).

Version/Option/Versión

Tête à bouts carrés (BC). Tête à bouts ronds (BR). Avec cylindre profilé laiton, 30 x 30 mm, 3 clés.
Square (BC). Round (BR) ended forend. With brass profile cylinder, 30 x 30 mm, 3 keys.
Cabeza de extremos cuadrados (BC). Cabeza de extremos redondos (BR). Con cilindro perfilado de latón, 30 x 30 mm, 3 llaves.

Designation	Boite	Colis.	Prix	Sachet	Colis.	Prix	Brochable					Colis.	Prix
							France	Euro 1	Euro 2	Euro 3	Euro 4		
Serrure axe 40mm à cylindre profilé V/BC 3 clés	00080104	10	-	-	-	-	00480104	-	-	-	-	10	-
Serrure axe 40mm à cylindre profilé V/BR 3 clés	00081104	10	-	-	-	-	00481104	-	-	-	-	10	-
Boîtier serrure axe 40mm à cylindre V/BC	00080106	10	-	-	-	-	00480106	-	-	-	-	10	-
Boîtier serrure axe 40mm à cylindre V/BR	00081106	10	-	-	-	-	00481106	-	-	-	-	10	-
Boîtier serrure axe 40mm à cylindre Z/BR	00081116	10	-	00981116	10	-	00481116	-	-	-	-	10	-

Tarif conditionnement non décollable

Boîtier serrure axe 40 mm à cylindre 2 tours Z/BR/L sans gâche (par 50 pièces non décollable)	00051096	50	-	-	-	-	-	-	-	-	-	-	-
Gâche type cylindre Z/BR (par 50 pièces non décollable)	00081002	50	-	-	-	-	-	-	-	-	-	-	-

Non stocké/Non-stored/Producto no estocado - Sur stock Europe Zone 1 et Zone 2, nous consulter pour délai d'approvisionnement - Epuisement/Stock depletion/Agotamiento del stock

Axe à 40 mm / A CYLINDRE PROTECT

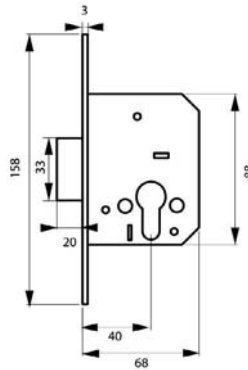

GARANTIE

Description/Description/Descripción

Coffre acier embouti épaisseur 15 mm. Tête acier bouts carrés. Pêne alliage zingué . Gâche plate acier.
Stamped steel case thickness 15 mm. Steel forend. Zinc plated alloy bolt. Steel flat striker.
Caja de acero embutido espesor 15 mm. Cabeza de

acero. estillo de aleación cincada . Cerradero plano de acero.

Finition/Finish/Acabado

Zingué
Zinc coated
Cincado

Designation	Boite	Colis.	Prix	Sachet	Colis.	Prix	Brochable					Colis.	Prix	
							France	Euro 1	Euro 2	Euro 3	Euro 4			
Boîtier serrure axe 40mm à cylindre - Pêne dormant seul	00094514	1	-	-	-	-	-	-	-	-	00494514	-	5	-

Axe à 40 mm / A CYLINDRE PROTECT

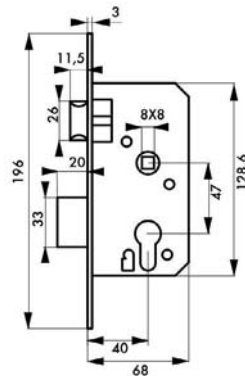

GARANTIE

Description/Description/Descripción

Coffre acier embouti. Tête acier bouts ronds. Demi-tour réversible sans démontage du coffre. Pêne alliage zingué . Gâche plate acier. Carré 8 mm, entr'axe 47 mm. Rappel du 1/2 tour par la clé.
Stamped steel case. Steel forend. Reversible latch without removing the case. Zinc plated alloy bolt. Steel flat striker. Square 8 mm. Draw back of the latch by key.
Caja de acero embutido. Cabeza de acero. Media vuelta

reversible sin desmontar la caja. Pestillo de aleación cincada . Cerradero plano de acero. Cuadrado 8 mm. Reposición de la media vuelta con la llave.

Finition/Finish/Acabado

Tête laitonée. Tête nickelée.
Brass plated forend. Nickel forend.
Cabeza de latónado. Cabeza níquelado

Designation	Boite	Colis.	Prix	Sachet	Colis.	Prix	Brochable					Colis.	Prix	
							France	Euro 1	Euro 2	Euro 3	Euro 4			
Boîtier serrure axe 40mm à cylindre tête laitonée	00094365	1	-	-	-	-	-	-	-	-	00494365	-	5	-
Boîtier serrure axe 40mm à cylindre tête nickelée	00094524	1	-	-	-	-	-	-	-	-	00494524	-	5	-

Non stocké/Non-stored/Producto no estocado - Sur stock Europe Zone 1 et Zone 2, nous consulter pour délai d'approvisionnement - Epuisement/Stock depletion/Agotamiento del stock

Axe à 40 mm / A CYLINDRE PROTECT

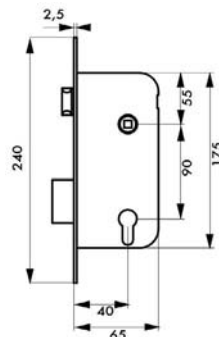

GARANTIE

Description/Description/Descripción

Coffre acier embouti. Têtière acier bouts ronds. Demi-tour réversible sans démontage du coffre. Pêne alliage zingué bichromaté. Gâche plate acier. Carré 8 mm, entraxe 90 mm. Sans rappel du 1/2 tour par la clé. *Stamped steel case. Steel forend. Reversible latch without removing the case. Zinc plated alloy bolt. Steel flat striker. Square 8 mm. Without drawback of the latch by the key.* Caja de acero embutido. Cabeza de acero. Media vuelta

reversible sin desmontar la caja. Pestillo de aleación cincada. Cerradero plano de acero. Cuadrado 8 mm. reposición de la media vuelta con llave.

Finition/Finish/Acabado

Noir, Zingué
Black, Zinc coated
Negro, Cincado

Designation	Boite	Colis.	Prix	Sachet	Colis.	Prix	Brochable				Colis.	Prix	
							France	Euro 1	Euro 2	Euro 3			Euro 4
Boîtier serrure axe 40mm à cylindre V/BR	-	-	-	-	-	-	-	-	00492251 NS	-	-	5	-
Boîtier serrure axe 40mm à cylindre Z/BR	-	-	-	-	-	-	-	-	00492254 NS	-	-	5	-

Axe à 40 mm / A CYLINDRE ECO

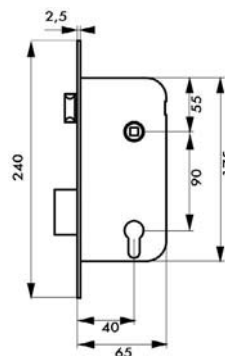

GARANTIE

Description/Description/Descripción

Coffre acier embouti. Têtière acier bouts ronds. Demi-tour réversible sans démontage du coffre. Pêne alliage zingué. Gâche plate acier. Carré 8 mm, entraxe 90 mm. Sans rappel du 1/2 tour par la clé. *Stamped steel case. Steel forend. Reversible latch without removing the case. Zinc plated alloy bolt. Steel flat striker. Square 8 mm. Without drawback of the latch by the key.* Caja de acero embutido. Cabeza de acero. Media vuelta

reversible sin desmontar la caja. Pestillo de aleación cincada. Cerradero plano de acero. Cuadrado 8 mm. No reposición de la media vuelta con llave.

Finition/Finish/Acabado

Zingué
Zinc coated
Cincado

Designation	Boite	Colis.	Prix	Sachet	Colis.	Prix	Brochable				Colis.	Prix	
							France	Euro 1	Euro 2	Euro 3			Euro 4
Boîtier serrure axe 40mm à cylindre Z/BR	-	-	-	00992535	10	-	-	-	00492535 NS	-	-	5	-
Serrure axe 40mm à cylindre profilé Z/BR 3 clés	-	-	-	-	-	-	-	-	00492592 NS	-	-	5	-

NS Non stocké/Non-stored/Producto no estocado - E Sur stock Europe Zone 1 et Zone 2, nous consulter pour délai d'approvisionnement - E Epuisement/Stock depletion/Agotamiento del stock

Axe à 40 mm / A CYLINDRE, TÊTIÈRE AFFLEURANTE RESIST



GARANTIE

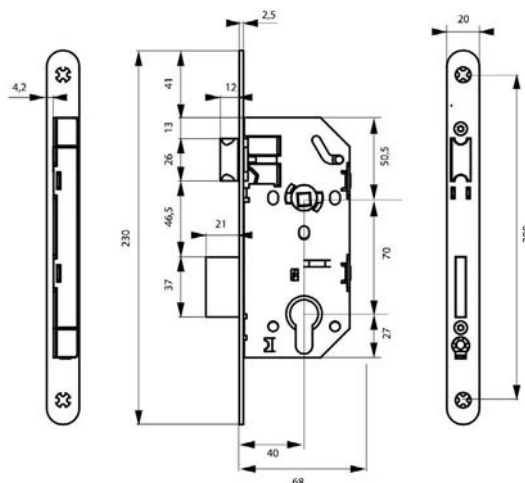

Description/Description/Descripción

Coffre acier embouti. Tête acier bouts ronds. Demi-tour bipente alliage. Pêne acier galvanisé. Gâche acier zingué. Mécanisme à 2 tours. Rappel du 1/2 tour par la clé. Carré 7 mm, entr'axe 70 mm.

Stamped steel case. Round ended steel forend. Alloy latch. Galvanised steel bolt. Zinc plated steel striker. Double deadbolt throw. Draw back of the latch by key. Square 7 mm.

Caja de acero embutido. Cabeza de extremos redondos. Media vuelta de aleación. Pestillo de acero galvanizado. Cerradero de acero cincado. Mecanismo de 2 vueltas. Reposición de la media vuelta con la llave. Cuadrado 7 mm.

Finition/Finish/Acabado

Coffre galvanisé, tête epoxy noir granité

Case galvanised, forend black epoxy

Caja galvanizado, cabeza epoxy negro

Version/Option/Versión

Possibilité carré 8 mm sur demande

Square 8 mm on request.

Cuadrado 8 mm a petición.

Designation	Boite	Colis.	Prix	Sachet	Colis.	Prix	Brochable					Colis.	Prix
							France	Euro 1	Euro 2	Euro 3	Euro 4		
Boîtier serrure axe 40mm à cylindre MONOMAX tête affleurante BR - droite	00086830	5	-	-	-	-	-	-	-	-	-	-	-
Boîtier serrure axe 40mm à cylindre MONOMAX tête affleurante BR - gauche	00086835	5	-	-	-	-	-	-	-	-	-	-	-

Non stocké/Non-stored/Producto no estocado - Sur stock Europe Zone 1 et Zone 2, nous consulter pour délai d'approvisionnement - Epuisement/Stock depletion/Agotamiento del stock

Axe à 40 mm / A CYLINDRE, 2 TOURS

RESIST



GARANTIE



Essais selon la norme NF

EN 12209

Classification

3S400G3HC30

Caractéristiques certifiées NF :
endurance, durabilité, sécurité.

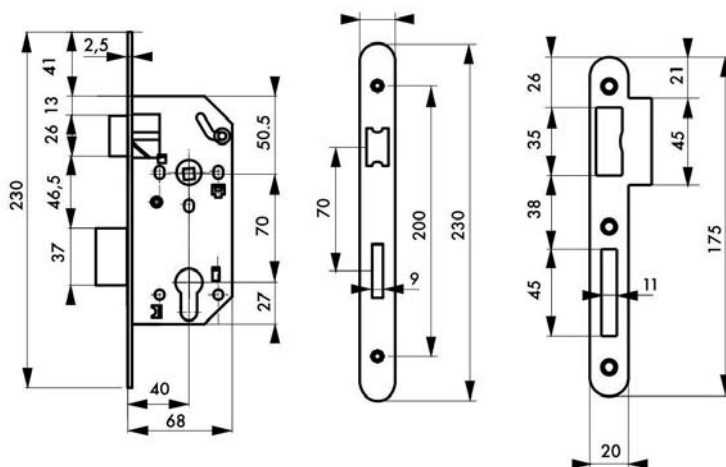

Description/Description/Descripción

Coffre acier embouti. Têtière acier bouts ronds. Demi-tour bipente alliage réversible sans démontage du coffre. Pêne acier galvanisé. Gâche plate acier zingué. Mécanisme à 2 tours. Rappel du 1/2 tour par la clé. Carré 7 mm, entr'axe 70 mm.

Stamped steel case. Round ended steel forend. Reversible alloy latch without removing the case. Galvanized steel bolt. Zinc plated steel flat striker. Double deadbolt throw. Draw back of the latch by key. Square 7 mm.

Caja de acero embutido. Cabeza de extremos redondos. Media vuelta de aleación reversible sin desmontar la caja. Pestillo de acero galvanizado. Cerradero plano de acero cincado. Mecanismo de 2 vueltas. Reposición de la media vuelta con la llave. Cuadrado 7 mm.

Finition/Finish/Acabado

Coffre galvanisé, tèteière epoxy noir granité

Case galvanized, forend black epoxy

Caja galvanizado, cabeza epoxy negro

Version/Option/Versión

Tèteière inox, acier laitonné, acier nickelé. Possibilité carré 8 mm sur demande. Tèteière bouts carrés (BC). Tèteière bouts ronds (BR).

Stainless steel forend, brass plated forend, nickel plated forend. Square 8 mm on request. Square (BC). Round (BR) ended forend.

Cabeza de acero inoxidable, acero latonado, acero niquelado. Cuadrado 8 mm a petición. Cabeza de extremos cuadrados (BC). Cabeza de extremos redondos (BR).

Designation	Boite	Colis.	Prix	Sachet	Colis.	Prix	Brochable					Colis.	Prix
							France	Euro 1	Euro 2	Euro 3	Euro 4		
Boitier MONOMAX NF à cylindre axe 40mm tête noire BR	00546830	5	-	00946830	20	-	00446830	-	-	-	-	5	-
Boitier MONOMAX NF à cylindre axe 40mm tête noire BC	00546930	5	-	-	-	-	-	-	-	-	-	-	-
Boitier MONOMAX NF à cylindre axe 40mm tête inox BR	00546831	5	-	-	-	-	00446831	-	-	-	-	-	-
Boitier MONOMAX NF à cylindre axe 40mm tête laitonée BR	00546832	5	-	-	-	-	-	-	-	-	-	-	-
Boitier MONOMAX NF à cylindre axe 40mm tête nickelée BR	00546833	5	-	-	-	-	-	-	-	-	-	-	-

Tarif conditionnement non décolisable

Boitier MONOMAX NF à cylindre axe 40mm tête noire BR sans gâche (25 pièces non décolisable)	00046830	25	-	-	-	-	-	-	-	-	-	-	-
Gâche acier pour serrure NORME NF à pêne dormant ½ tour (25 pièces non décolisable)	00046102	25	-	-	-	-	-	-	-	-	-	-	-
Boitier MONOMAX NF à cylindre axe 40mm tête inox BR sans gâche (25 pièces non décolisable)	00046831	25	-	-	-	-	-	-	-	-	-	-	-
Gâche inox pour serrure NORME NF à pêne dormant ½ tour (25 pièces non décolisable)	00046103	25	-	-	-	-	-	-	-	-	-	-	-

Tarif garniture

Garniture MONOMAX NF axe 40mm à cylindre 3 clés V/BR + ensemble ARES	00022167	30	-	-	-	-	-	-	-	-	-	-	-
Garniture MONOMAX NF axe 40mm à cylindre 3 clés V/BR + ensemble DEMETER	00022237	30	-	-	-	-	-	-	-	-	-	-	-
Garniture MONOMAX NF axe 40mm à cylindre 3 clés V/BR + ensemble LETO	00022177	30	-	-	-	-	-	-	-	-	-	-	-
Garniture MONOMAX NF axe 40mm à cylindre 3 clés V/BR + ensemble VESTA	00022187	30	-	-	-	-	-	-	-	-	-	-	-
Garniture MONOMAX NF axe 40mm à cylindre 3 clés V/BR + ensemble CHARON	00022207	30	-	-	-	-	-	-	-	-	-	-	-
Garniture MONOMAX NF axe 40mm à cylindre 3 clés V/BR + ensemble DIONYSOS	00022197	30	-	-	-	-	-	-	-	-	-	-	-
Garniture MONOMAX NF axe 40mm à cylindre 3 clés V/BR + ensemble DIANE	00022217	30	-	-	-	-	-	-	-	-	-	-	-
Garniture MONOMAX NF axe 40mm à cylindre 3 clés V/BR + ensemble OURANUS	00022227	30	-	-	-	-	-	-	-	-	-	-	-
Garniture MONOMAX NF axe 40mm à cylindre 3 clés V/BR + ensemble PELOPE	00022247	30	-	-	-	-	-	-	-	-	-	-	-

☒ Non stocké/Non-stored/Productos no estocado - ☑ Sur stock Europe Zone 1 et Zone 2, nous consulter pour délai d'approvisionnement - ☒ Epuement/Stock depletion/Agotamiento del stock

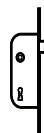

Axe à 45 mm / A CYLINDRE RESIST

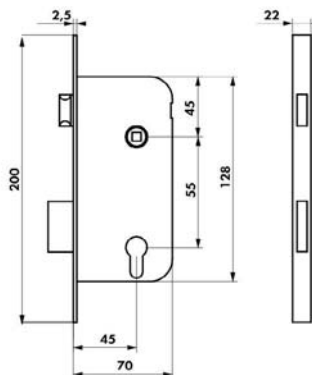

GARANTIE

Description/Description/Descripción

Coffre acier embouti épaisseur 14,5 mm. Tête acier bouts ronds. Demi-tour réversible sans démontage du coffre. Pêne alliage zingué. Gâche plate acier. Carré 8 mm, entr'axe 55 mm. Sans rappel du 1/2 tour par la clé. *Stamped steel case thickness 14,5mm. Steel forend. Reversible latch without removing the case. Zinc plated alloy bolt. Steel flat striker. Square 8 mm. Without drawback of the latch by the key.*

Caja de acero embutido espesor 14,5 mm. Cabeza de

acero. Media vuelta reversible sin desmontar la caja. Pestillo de aleación cincada. Cerradero plano de acero. Cuadrado 8 mm. No reposición de la media vuelta con llave.

Finition/Finish/Acabado

Zingué
Zinc coated
Cincado

Designation	Boite	Colis.	Prix	Sachet	Colis.	Prix	Brochable					Colis.	Prix
							France	Euro 1	Euro 2	Euro 3	Euro 4		
Boîtier serrure axe 45mm à cylindre - tête blanche	-	-	-	-	-	-	-	-	00492438 NS	-	-	5	-

Axe à 45 mm / A CYLINDRE RESIST

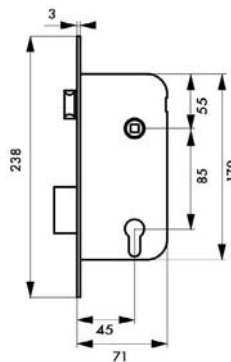

GARANTIE

Description/Description/Descripción

Coffre acier embouti épaisseur 13 mm. Tête acier bouts Carrés. Demi-tour réversible sans démontage du coffre. Pêne alliage zingué. Gâche plate acier. Carré 8 mm, entr'axe 85 mm. Rappel du 1/2 tour par la clé. *Stamped steel case thickness 13 mm. Steel forend. Reversible latch without removing the case. Zinc plated alloy bolt. Steel flat striker. Square 8 mm. Draw back of the latch by key.*

Caja de acero embutido espesor 13 mm. Cabeza de acero. Media vuelta reversible sin desmontar la caja. Pestillo de aleación cincada. Cerradero plano de acero. Cuadrado 8 mm. Reposición de la media vuelta con la llave.

Finition/

Tête laitonée
Brass plated forend
Cabeza latónado

Designation	Boite	Colis.	Prix	Sachet	Colis.	Prix	Brochable					Colis.	Prix
							France	Euro 1	Euro 2	Euro 3	Euro 4		
Boîtier serrure axe 45mm à cylindre - tête laitonée	00094343	1	-	-	-	-	-	-	-	00494343	-	5	-

NS Non stocké/Non-stored/Producto no estocado - E Sur stock Europe Zone 1 et Zone 2, nous consulter pour délai d'approvisionnement - E Epusement/Stock depletion/Agotamiento del stock

Axe à 45 mm / A CYLINDRE RESIST

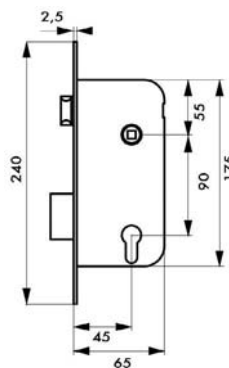

GARANTIE

Description/Description/Descripción

Coffre acier embouti. Têtière acier bouts ronds. Demi-tour réversible sans démontage du coffre. Pêne alliage zingué bichromaté. Gâche plate acier. Carré 8 mm. Entraxe 90 mm. Sans rappel du 1/2 tour par la clé.

Stamped steel case. Steel forend. Reversible latch without removing the case. Zinc plated alloy bolt. Steel flat striker. Square 8 mm. Without drawback of the latch by the key.

Caja de acero embutido. Cabeza de acero. Media vuelta

reversible sin desmontar la caja. Pestillo de aleación cincada. Cerradero plano de acero. Cuadrado 8 mm. No reposición de la media vuelta con llave.

Finition/Finish/Acabado

Noir, zingué, marron
Black, zinc coated, brown
Negro, cincado, marón

Designation	Boite	Colis.	Prix	Sachet	Colis.	Prix	Brochable					Colis.	Prix
							France	Euro 1	Euro 2	Euro 3	Euro 4		
Boîtier serrure axe 45mm à cylindre époxy noir	-	-	-	-	-	-	-	-	00492257 NS	-	-	5	-
Boîtier serrure axe 45mm à cylindre acier zingué	-	-	-	-	-	-	-	-	00492260 NS	-	-	5	-
Boîtier serrure axe 45mm à cylindre époxy marron	-	-	-	-	-	-	-	-	00492441 NS	-	-	5	-
Serrure axe 45mm à cylindre profilé époxy marron, 3 clés	-	-	-	-	-	-	-	-	00492246 NS	-	-	5	-

Axe à 45 mm / A CYLINDRE RESIST

DISPONIBLE JUSQU'À
ÉPUISEMENT DES STOCKS

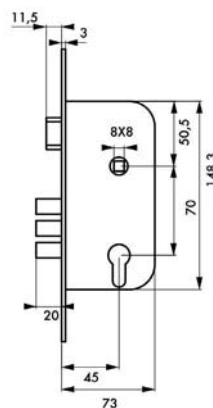

GARANTIE

Description/Description/Descripción

Coffre acier embouti épaisseur 15 mm. Têtière acier bouts Carrés. Demi-tour réversible sans démontage du coffre. Pêne alliage zingué. Gâche plate acier. Carré 8 mm, entr'axe 70 mm. Rappel du 1/2 tour par la clé.

Stamped steel case thickness 15 mm. Steel forend. Reversible latch without removing the case. Zinc plated alloy bolt. Steel flat striker. Square 8 mm. Draw back of the latch by key.

Caja de acero embutido espesor 15 mm. Cabeza de acero. Media vuelta reversible sin desmontar la caja. Pestillo de aleación cincada. Cerradero plano de acero. Cuadrado 8 mm. Reposición de la media vuelta con la llave.

Finition/Finish/Acabado

Têtière laitonnée
Brass plated forend
Cabeza latónado

Designation	Boite	Colis.	Prix	Sachet	Colis.	Prix	Brochable					Colis.	Prix
							France	Euro 1	Euro 2	Euro 3	Euro 4		
Boîtier serrure axe 45mm à cylindre, 3 pènes - têtère laitonée	00094518	1	-	-	-	-	-	-	-	00494518	-	5	-

NS Non stocké/Non-stored/Producto no estocado - S Sur stock Europe Zone 1 et Zone 2, nous consulter pour délai d'approvisionnement - E Epuisement/Stock depletion/Agotamiento del stock

Axe à 45 mm / A CYLINDRE RESIST

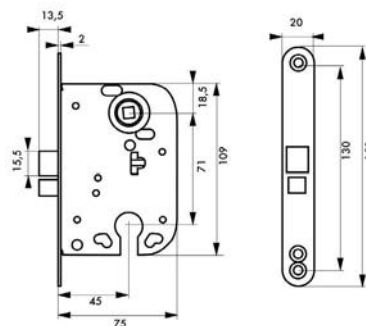

GARANTIE

Description/Description/Descripción

Coffre acier embouti. Têtière acier bouts ronds. Pêne alliage zingué. Gâche plate acier. Carré 8 mm, entr'axe 72 mm. Rappel du 1/2 tour par la clé.

Stamped steel case. Steel forend. Zinc plated alloy bolt. Steel flat striker. Square 8 mm. Draw back of the latch by key.

Caja de acero embutido. Cabeza de acero. Pestillo de

aleación cincada. Cerradero plano de acero. Cuadrado 8 mm. Reposición de la media vuelta con la llave.

Finition/Finish/Acabado

Têtière laitonée
Brass plated forend
Cabeza latónado

Designation	Boite	Colis.	Prix	Sachet	Colis.	Prix	Brochable					Colis.	Prix
							France	Euro 1	Euro 2	Euro 3	Euro 4		
Boîtier serrure axe 45mm à cylindre	00093667 NS	1	-	-	-	-	-	00493667 NS NS	-	-	-	5	-

Axe à 45 mm / POUR CYLINDRE, 2 TOURS RESIST



Essais selon la norme NF

EN 12209

Classification

3 5 4 0 0 G 3 H C 3 0

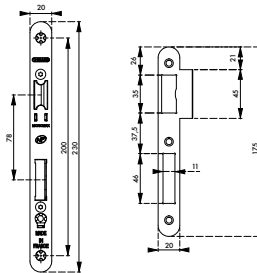
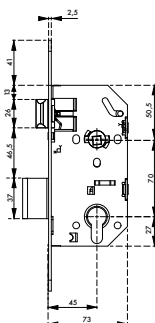

Caractéristiques certifiées NF :
endurance, durabilité, sécurité.



GARANTIE

Description/Description/Descripción

Coffre acier embouti. Têtière acier. Demi-tour bipente alliage réversible sans démontage du coffre. Pêne acier galvanisé. Gâche plate acier zingué. Mécanisme à 2 tours. Rappel du 1/2 tour par la clé. Carré 7 mm, entr'axe 70 mm.

Stamped steel case. Steel forend. Reversible alloy latch without removing the case. Galvanised steel bolt. Zinc plated steel fl at striker. Double deadbolt throw. Draw back of the latch by key. Square 7 mm.

Caja de acero embutido. Cabeza de acero. Media vuelta

de aleación reversible sin desmontar la caja. Pestillo de acero galvanizado. Cerradero plano de acero cincado. Mecanismo de 2 vueltas. Reposición de la media vuelta con la llave. Cuadrado 7 mm.

Finition/Finish/Acabado

Coffre galvanisé, têtère epoxy noir granité.
Case galvanised, forend black epoxy.
Caja galvanizado, cabeza epoxy negro.

Designation	Boite	Colis.	Prix	Sachet	Colis.	Prix	Brochable					Colis.	Prix
							France	Euro 1	Euro 2	Euro 3	Euro 4		
Boîtier MONOMAX NF axe 45mm à cylindre têtère noire BR	00566830	5	-	-	-	-	00466830	-	-	-	-	5	-

Tarif conditionnement non décollable

Boîtier MONOMAX NF axe 45mm à cylindre têtère noire BR (25 pièces non décollable)	00066830	25	-	-	-	-	-	-	-	-	-	-	-
---	----------	----	---	---	---	---	---	---	---	---	---	---	---

NS Non stocké/Non-stored/Producto no estocado - S Sur stock Europe Zone 1 et Zone 2, nous consulter pour délai d'approvisionnement - E Epuisement/Stock depletion/Agotamiento del stock

Axe à 50 mm / POUR CYLINDRE, 1 TOUR

ECO



GARANTIE

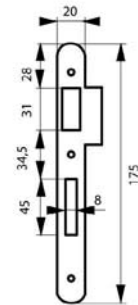
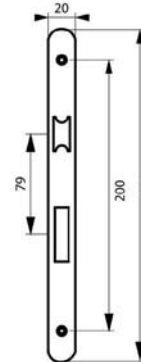
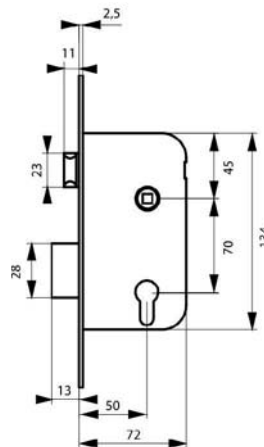

Description/Description/Descripción

Coffre acier embouti épaisseur 10 mm. Tête acier. Demi-tour alliage zingué réversible sans démontage du coffre. Pêne acier zingué. Gâche plate acier. Carré 7 mm, entr'axe 70 mm. Sans rappel du 1/2 tour par la clé.

Stamped steel case 10 mm thickness. Steel forend. Reversible zinc plated alloy latch without removing the case. Zinc plated steel bolt. Steel flat striker. Square 7 mm. Without drawback of the latch by the key.

Caja de acero embutido 10 mm de espesor. Cabeza de acero. Media vuelta de aleación cincado reversible sin desmontar la caja. Pestillo de acero cincado. Cerradero plano de acero. Cuadrado 7 mm. No reposición de la media vuelta con llave.

Finition/Finish/Acabado
Epoxy blanc (V) Gris métal
White epoxy (V) Metal gray
White epoxy (V) Metal gray

Designation	Boite	Colis.	Prix	Sachet	Colis.	Prix	Brochable					Colis.	Prix
							France	Euro 1	Euro 2	Euro 3	Euro 4		
Boîtier serrure axe à 50mm à cylindre, coffre épaisseur 10 mm V/BR	-	-	-	00913936	10	-	00413936	-	-	-	-	5	-
Boîtier serrure axe à 50mm à cylindre, coffre épaisseur 10 mm gris métal V/BR	-	-	-	00913937	10	-	-	-	-	-	-	-	-
Tarif conditionnement non décolisable													
Boîtier serrure axe à 50mm à cylindre, coffre épaisseur 10 mm V/BR	00013936	50	-	-	-	-	-	-	-	-	-	-	-
Boîtier serrure axe à 50mm à cylindre, coffre épaisseur 10 mm gris métal/BR	00013937	50	-	-	-	-	-	-	-	-	-	-	-
Tarif garniture													
Garniture serrure Eco+ axe 50mm à cylindre V/BR 3 clés + ensemble ARES	00022168	30	-	00922168	30	-	-	-	-	-	-	-	-
Garniture serrure Eco+ axe 50mm à cylindre V/BR 3 clés + ensemble LETO	00022178	30	-	00922178	30	-	-	-	-	-	-	-	-
Garniture serrure Eco+ axe 50mm à cylindre V/BR 3 clés + ensemble VESTA	00022188	30	-	00922188	30	-	-	-	-	-	-	-	-
Garniture serrure Eco+ axe 50mm à cylindre V/BR 3 clés + ensemble DIONYSOS	00022198	30	-	00922198	30	-	-	-	-	-	-	-	-

Non stocké/Non-stored/Producto no estocado - Sur stock Europe Zone 1 et Zone 2, nous consulter pour délai d'approvisionnement - Epuisement/Stock depletion/Agotamiento del stock



GARANTIE



Description/Description/Descripción

Coffre acier embouti. Têtière acier, laiton ou inox.
Demi-tour alliage zingué réversible sans démontage du coffre. Pêne alliage zingué ou laiton. Gâche plate acier.
Mécanisme à 2 tours. Rappel du 1/2 tour par la clé. Carré 7 mm, entr'axe 70 mm.

Stamped steel case. - Steel, brass or stainless steel forend - Reversible. zinc plated alloy bolt without removing the case. Brass or zinc plated alloy bolt - Steel flat striker. Double deadbolt throw. Draw back of the latch by key. Square 7 mm.

Caja de acero embutido. Cabeza de acero, latón o acero inoxidable. Media vuelta de aleación cincado reversible sin desmontar la caja. Pestillo de aleación cincado o de latón. Cerradero plano de acero. Mecanismo de 2 vueltas. Reposición de la media vuelta con la llave. Cuadrado 7 mm.

Finition/Finish/Acabado

Epoxy noir granité (V). Zingué (Z). Electrozingué (EZ)
Black epoxy (V) - Zinc plated (Z)
Epoxi negro granitado (V). Cincado (Z) - Electroincado (EZ)

Version/Option/Versión

Têtière bouts carrés (BC) et ronds (BR) Têtière laitonée - Têtière acier vieilli - Têtière acier nickelé - Têtière nickelée - Têtière laiton brossé - Têtière laiton poli verni - Têtière laiton poli nickelé - Têtière inox brossé - Têtière inox 200 x 22 - Demi-tour et pêne laiton - Gâche plate acier, zingué, laiton ou inox

Square (BC) - Round (BR) ended forend - Brass plated forend - Old steel forend - Nickel plated steel forend Nickel plated forend - Brushed brass forend - Varnish polished brass forend - Polish nickel plated brass forend - Brushed stainless steel forend - 200 x 22 stainless steel forend - Steel, zinc plated, brass or stainless steel flat striker.

Cabeza de extremos cuadrados (BC) y redondos (BR) Cabeza latonada - Cabeza de acero envejecido Cabeza de acero niquelado - Cabeza niquelada Cabeza de latón cepillado - Cabeza de latón pulido barnizado - Cabeza de latón pulido niquelado - Cabeza de acero inoxidable cepillado - Cabeza de acero inoxidable de 200 x 22. Media vuelta y pestillo de latón Cerradero plano de acero, cincado, latón o acero inoxidable.

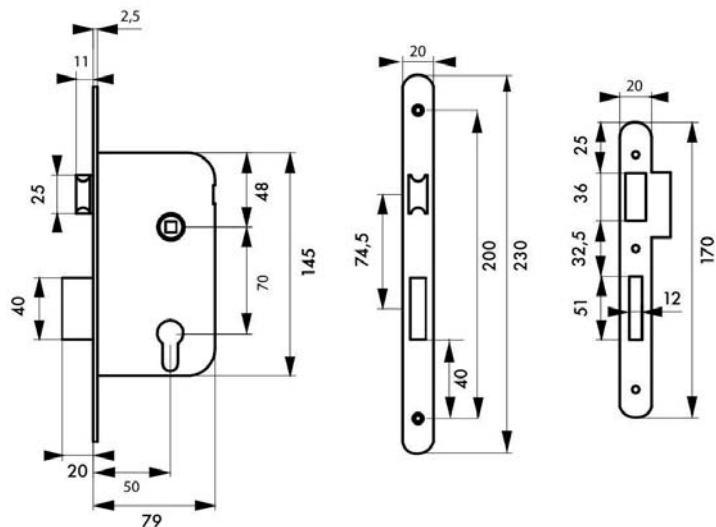

Designation	Boîte	Colis.	Prix	Sachet	Colis.	Prix	Brochable					Colis.	Prix
							France	Euro 1	Euro 2	Euro 3	Euro 4		
Boîtier serrure axe à 50mm à cylindre tête acier laitonné V/BC/L	00000206	5	-	-	-	-	-	-	-	-	-	-	-
Boîtier serrure axe à 50mm à cylindre tête acier laitonné V/BR/L	00001206	5	-	-	-	-	-	-	-	-	-	-	-
Boîtier serrure axe à 50mm à cylindre tête acier nickelé V/BC/L	00000606	5	-	-	-	-	-	-	-	-	-	-	-
Boîtier serrure axe à 50mm à cylindre tête acier nickelé V/BR/L	00001606	5	-	-	-	-	-	-	-	-	-	-	-
Boîtier serrure axe à 50mm à cylindre tête laiton brossé V/BC/L	00000906	5	-	-	-	-	-	-	-	-	-	-	-
Boîtier serrure axe à 50mm à cylindre tête laiton brossé V/BR/L	00001906	5	-	-	-	-	-	-	-	-	-	-	-
Boîtier serrure axe à 50mm à cylindre tête laiton poli verni V/BR/L	00019226	5	-	-	-	-	-	-	-	-	-	-	-
Boîtier serrure axe à 50mm à cylindre tête laiton poli nickelé V/BR/L	00019216	5	-	-	-	-	-	-	-	-	-	-	-
Boîtier serrure axe à 50mm à cylindre tête inox brossé Z/BC/L	00000996	5	-	-	-	-	-	-	-	-	-	-	-
Boîtier serrure axe à 50mm à cylindre tête inox brossé Z/BR/L	00002996	5	-	-	-	-	-	-	-	-	-	-	-
Boîtier serrure axe à 50mm à cylindre tête 200 x 22 mm inox Z/BC/L	00009996	5	-	-	-	-	-	-	-	-	-	-	-
Boîtier serrure axe à 50mm à cylindre pêne dormant seul V/BC/Z	00009706	5	-	-	-	-	-	-	-	-	-	-	-
Boîtier serrure axe à 50mm à cylindre pêne dormant seul V/BR/Z	00091706	5	-	-	-	-	-	-	-	-	-	-	-

☒ Non stocké/Non-stored/Producto no estocado - ☑ Sur stock Europe Zone 1 et Zone 2, nous consulter pour délai d'approvisionnement - ☒ Epuement/Stock depletion/Agotamiento del stock

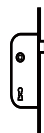

Axe à 50 mm / A CYLINDRE, 2 TOURS

PROTECT

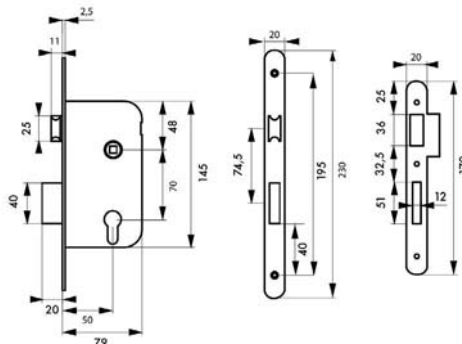

GARANTIE



X 3

Description/Description/Descripción

Coffre acier embouti. Têtière acier. Demi-tour alliage zingué. réversible sans démontage du coffre. Pêne alliage zingué. Gâche plate acier. Mécanisme à 2 tours. Rappel du 1/2 tour par la clé. Carré 7 mm, entr'axe 70 mm. Cylindre profilé laiton 30 x 30 mm. 3 clés en acier nickelé.

Stamped steel case. Steel forend/flat striker. Reversible bichromated zinc. plated alloy latch without removing the case. Brass bolt. Square 7 mm. Double deadbolt throw. Draw back of the latch by key. Brass profile cylinder 30 x 30 mm. 3 flat keys nickel plated steel.

Caja de acero embutido. Cabeza de acero. Media vuelta de aleación bicromatada. reversible sin desmontar la

caja. Pestillo de latón. Cerradero plano de acero. Mecanismo de 2 vueltas. Reposición de la media vuelta con la llave. Cuadrado 7 mm.

Finition/Finish/Acabado

Epoxy noir (V)

Black epoxy (V)

Epoxi negro granitado (V)

Version/Option/Versión

Têtière bouts carrés (BC) Têtière bouts ronds (BR)

Square (BC) Round (BR) ended forend

Cabeza de extremos cuadrados (BC) Cabeza de extremos redondos (BR)

Designation	Boite	Colis.	Prix	Sachet	Colis.	Prix	Brochable					Colis.	Prix
							France	Euro 1	Euro 2	Euro 3	Euro 4		
Serrure axe 50 mm à cylindre profilé V/BC 3 clés	-	-	-	-	-	-	00400504	-	-	-	-	10	-
Serrure axe 50 mm à cylindre profilé V/BR 3 clés	-	-	-	-	-	-	00401504	-	-	-	-	10	-

Axe à 50 mm / MAGNETIQUE, A CYLINDRE, 2 TOURS

PROTECT



CONFORT D'UTILISATION : silence de fonctionnement, pas de pêne en saillie

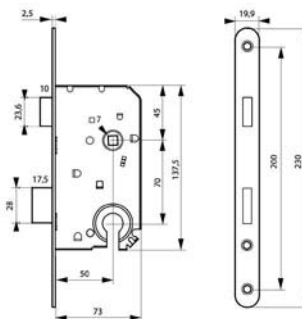

GARANTIE

Description/Description/Descripción

Coffre acier embouti. Têtière acier bouts ronds. Système magnétique à pêne rétractable. Gâche plate acier. Carré 7 mm, entraxe 70 mm.

Pressed steel safe. Steel rounded head forend. Magnetic system with retractable bolt. Steel flat strike. Square 7 mm.

Caja de acero embutido. Cabeza de acero extremos

redondos. Sistema magnético de pestillo retraíble. Gacheta plana de acero. Cuadrado 7 mm.

Finition/Finish/Acabado

Fer satiné

Satin iron

Hierro satinado

Designation	Boite	Colis.	Prix	Sachet	Colis.	Prix	Brochable					Colis.	Prix
							France	Euro 1	Euro 2	Euro 3	Euro 4		
Boîtier serrure axe 50mm magnétique à cylindre /BR	-	-	-	00901556	10	-	00401556	-	-	-	-	5	-

⚠ Non stocké/Non-stored/Producto no estocado - 📦 Sur stock Europe Zone 1 et Zone 2, nous consulter pour délai d'approvisionnement - 📦 Epuisement/Stock depletion/Agotamiento del stock

Axe à 50 mm / POUR CYLINDRE, 2 TOURS

PROTECT

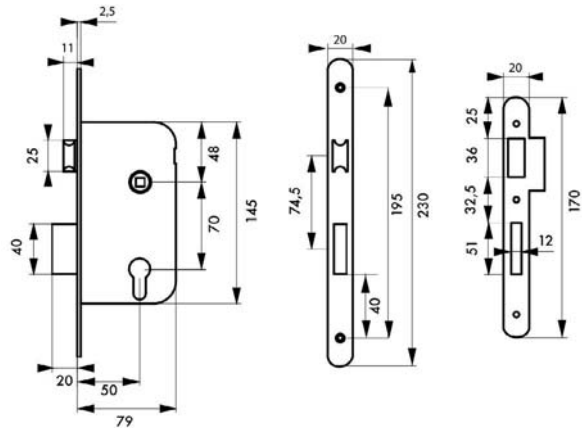

Description/Description/Descripción

Coffre acier embouti. Têtière acier. Demi-tour alliage zingué. réversible sans démontage du coffre. Pêne alliage zingué. Gâche plate acier. Mécanisme à 2 tours. Rappel du 1/2 tour par la clé. Carré 7 mm, entr'axe 70 mm. Stamped steel case. Steel forend. Reversible bichromated zinc plated alloy latch without removing the case. Zinc plated alloy bolt. Double deadbolt throw. Draw back of the latch by key. Square 7 mm.

Caja de acero embutido. Cabeza de acero. Media vuelta de aleación bicromatada reversible sin desmontar la caja. Pestillo de aleación cincado. Cerradero plano de acero. Mecanismo de 2 vueltas. Reposición de la media vuelta con la llave. Cuadrado 7 mm.

Finition/Finish/Acabado

Epoxy noir (V)Zingué (Z)
Black epoxy (V)Zinc plated (Z)
Epoxi negro granitado (V)Cincado (Z)

Version/Option/Versión

Têtière bouts carrés (BC)Têtière bouts ronds (BR)
Square (BC)Round (BR) ended forend
Cabeza de extremos cuadrados (BC)Cabeza de extremos redondos (BR)

Designation	Boite	Colis.	Prix	Sachet	Colis.	Prix	Brochable					Colis.	Prix
							France	Euro 1	Euro 2	Euro 3	Euro 4		
Boîtier serrure axe 50 mm à cylindre V/BC	-	-	-	-	-	-	00400506	-	-	-	-	10	-
Boîtier serrure axe 50 mm à cylindre V/BR	-	-	-	00901706	20	-	00401506	-	-	-	-	10	-
Boîtier serrure axe 50 mm à cylindre Z/BC	-	-	-	-	-	-	00410206	-	-	-	-	10	-
Boîtier serrure axe 50 mm à cylindre Z/BR	-	-	-	00911206	20	-	00411206	-	-	-	-	10	-

Tarif conditionnement non décolisable

Boîtier serrure axe à 50 mm à cylindre 2 tours V/BR sans gâche (50 pièces non décolisable)	00091506	50	-	-	-	-	-	-	-	-	-	-	-
Boîtier serrure axe à 50 mm à cylindre 2 tours Z/BR sans gâche (50 pièces non décolisable)	00051496	50	-	-	-	-	-	-	-	-	-	-	-
Gâche type cylindre 2 tours Z (50 pièces non décolisable)	00081002	50	-	-	-	-	-	-	-	-	-	-	-

☒ Non stocké/Non-stored/Producto no estocado - ☑ Sur stock Europe Zone 1 et Zone 2, nous consulter pour délai d'approvisionnement - ☒ Epuisement/Stock depletion/Agotamiento del stock

Axe à 50 mm / A CYLINDRE RESIST

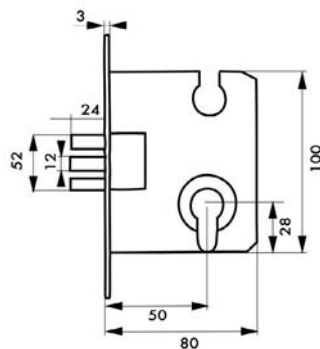

GARANTIE

Description/Description/Descripción

Coffre acier embouti. Têtière acier bouts ronds. Pêne alliage zingué. Gâche plate acier. entr'axe 72 mm.
Stamped steel case. Steel forend. Zinc plated alloy bolt. Steel flat striker.

Caja de acero embutido. Cabeza de acero. Pestillo de

aleación cincada. Cerradero plano de acero.

Finition/Finish/Acabado

Zingué
Zinc coated
Cincado

Designation	Boite	Colis.	Prix	Sachet	Colis.	Prix	Brochable					Colis.	Prix
							France	Euro 1	Euro 2	Euro 3	Euro 4		
Boîtier serrure axe à 50 mm à cylindre 3 pènes	00093665	1	-	-	-	-	-	00493665 NS	-	-	-	5	-

Axe à 50 mm / A CYLINDRE RESIST

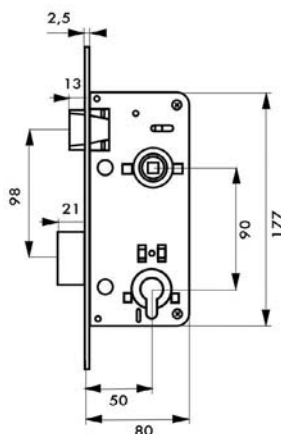

GARANTIE

Description/Description/Descripción

Coffre acier embouti. Têtière acier bouts ronds. Demi-tour réversible sans démontage du coffre. Pêne alliage zingué. Gâche plate acier. Carré 8 mm, entr'axe 90 mm.
Stamped steel case. Steel forend. Reversible latch without removing the case. Zinc plated alloy bolt. Steel flat striker. Square 8 mm.

Caja de acero embutido. Cabeza de acero. Media vuelta reversible sin desmontar la caja. Pestillo de aleación cincada. Cerradero plano de acero. Cuadrado 8 mm.

Finition/Finish/Acabado

Zingué
Zinc coated
Cincado

Designation	Boite	Colis.	Prix	Sachet	Colis.	Prix	Brochable					Colis.	Prix
							France	Euro 1	Euro 2	Euro 3	Euro 4		
Boîtier serrure axe à 50 mm à cylindre Z/BR	00090310	1	-	00992606	10	-	-	00493310 NS	00492310 NS	-	-	5	-

NS Non stocké/Non-stored/Producto no estocado - M Sur stock Europe Zone 1 et Zone 2, nous consulter pour délai d'approvisionnement - E Epusement/Stock depletion/Agotamiento del stock

Axe à 50 mm / A CYLINDRE RESIST

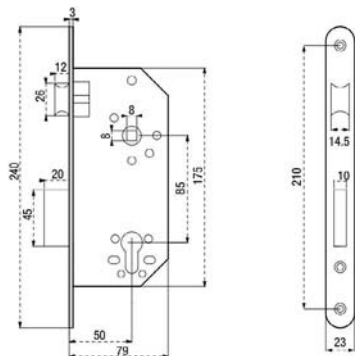

GARANTIE

Description/Description/Descripción

Coffre acier embouti épaisseur 15 mm. Têtière acier bouts ronds. Demi-tour réversible sans démontage du coffre. Pêne alliage zingué . Gâche plate acier. Carré 8 mm, entr'axe 85 mm. Rappel du 1/2 tour par la clé.
Stamped steel case thickness 15 mm. Steel forend. Reversible latch without removing the case. Zinc plated alloy bolt. Steel flat striker. Square 8 mm. Draw back of the latch by key.

Caja de acero embutido espesor 15 mm. Cabeza de acero. Media vuelta reversible sin desmontar la caja. Pestillo de aleación cincada . Cerradero plano de acero. Cuadrado 8 mm. Reposición de la media vuelta con la llave

Finition/Finish/Acabado

Têtière laitonée.Têtière nickelée.
Brass plated forend.Nickel forend.
Cabeza de latónado.Cabeza niquelado

Designation	Boite	Colis.	Prix	Sachet	Colis.	Prix	Brochable				Colis.	Prix	
							France	Euro 1	Euro 2	Euro 3			Euro 4
Boîtier serrure axe à 50 mm à cylindre têtère laitonée	00094327	1	-	-	-	-	-	-	-	00494327	-	5	-
Boîtier serrure axe à 50 mm à cylindre têtère nickelée	00094522	1	-	-	-	-	-	-	-	00494522	-	5	-

Axe à 50 mm / A CYLINDRE RESIST

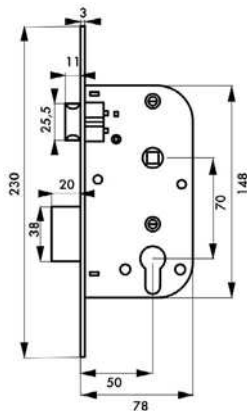

GARANTIE

Description/Description/Descripción

Coffre acier embouti. Têtière acier bouts carrés. Demi-tour réversible sans démontage du coffre. Pêne alliage zingué . Gâche plate acier. Carré 8 mm, entraxe 70 mm.Rappel du 1/2 tour par la clé.
Stamped steel case. Steel forend. Reversible latch without removing the case. Zinc plated alloy bolt. Steel flat striker. Square 8 mm. Draw back of the latch by key.
Caja de acero embutido. Cabeza de acero. Media vuelta

reversible sin desmontar la caja. Pestillo de aleación cincada . Cerradero plano de acero. Cuadrado 8 mm. Reposición de la media vuelta con la llave.

Finition/Finish/Acabado

Têtière laitonée.Têtière nickelée.
Brass plated forend.Nickel forend.
Cabeza de latónado.Cabeza niquelado

Designation	Boite	Colis.	Prix	Sachet	Colis.	Prix	Brochable				Colis.	Prix	
							France	Euro 1	Euro 2	Euro 3			Euro 4
Boîtier serrure axe à 50 mm à cylindre têtère laitonée	00094330	1	-	-	-	-	-	-	-	00494330	-	5	-
Boîtier serrure axe à 50 mm à cylindre têtère nickelée	00094523	1	-	-	-	-	-	-	-	00494523	-	5	-

Axe à 50 mm / A CYLINDRE RESIST

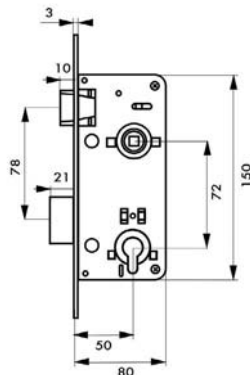

GARANTIE

Description/Description/Descripción

Coffre acier embouti. Têtière acier bouts ronds. Demi-tour réversible sans démontage du coffre. Pêne alliage zingué. Gâche plate acier. Carré 8 mm, entr'axe 72 mm. Stamped steel case. Steel forend. Reversible latch without removing the case. Zinc plated alloy bolt. Steel flat striker. Square 8 mm.

Caja de acero embutido. Cabeza de acero. Media vuelta

reversible sin desmontar la caja. Pestillo de aleación cincada. Cerradero plano de acero. Cuadrado 8 mm.

Finition/Finish/Acabado

Zingué
Zinc coated
Cincado

Designation	Boite	Colis.	Prix	Sachet	Colis.	Prix	Brochable					Colis.	Prix
							France	Euro 1	Euro 2	Euro 3	Euro 4		
Boîtier serrure axe à 50 mm à cylindre Z/BR	00093662	1	-	-	-	-	-	00493662 NS	-	-	-	5	-

Axe à 50 mm / A CYLINDRE RESIST

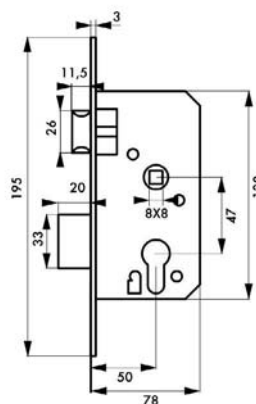

GARANTIE

Description/Description/Descripción

Coffre acier embouti. Têtière acier bouts ronds. Demi-tour réversible sans démontage du coffre. Pêne alliage zingué. Gâche plate acier. Carré 8 mm, entr'axe 47 mm. Rappel du 1/2 tour par la clé.

Stamped steel case. Steel forend. Reversible latch without removing the case. Zinc plated alloy bolt. Steel flat striker. Square 8 mm. Draw back of the latch by key.

Caja de acero embutido. Cabeza de acero. Media vuelta

reversible sin desmontar la caja. Pestillo de aleación cincada. Cerradero plano de acero. Cuadrado 8 mm. Reposición de la media vuelta con la llave.

Finition/Finish/Acabado

Têtière laitonée. Têtière nickelée.
Brass plated forend. Nickel forend.
Cabeza de latónado. Cabeza níquelado

Designation	Boite	Colis.	Prix	Sachet	Colis.	Prix	Brochable					Colis.	Prix
							France	Euro 1	Euro 2	Euro 3	Euro 4		
Boîtier serrure axe à 50 mm à cylindre tête laitonée	00094597	1	-	-	-	-	-	-	-	00494597	-	5	-
Boîtier serrure axe à 50 mm à cylindre tête nickelée	00094529	1	-	-	-	-	-	-	-	00494529	-	5	-

NS Non stocké/Non-stored/Producto no estocado - E Sur stock Europe Zone 1 et Zone 2, nous consulter pour délai d'approvisionnement - E Epusement/Stock depletion/Agotamiento del stock

Axe à 50 mm / A CYLINDRE RESIST



GARANTIE

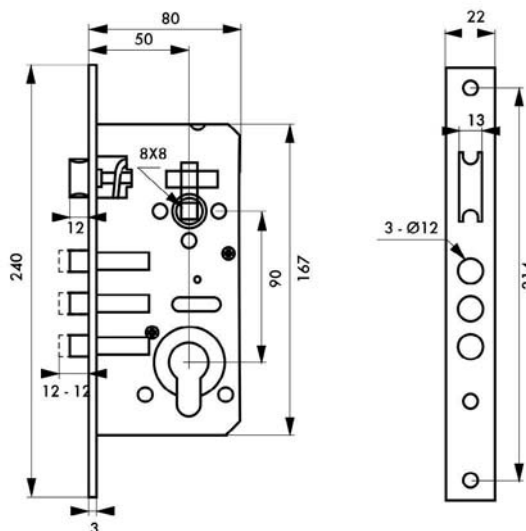

Description/Description/Descripción

Coffre acier embouti. Têtière acier bouts ronds. Demi-tour réversible sans démontage du coffre. Pêne alliage zingué. Gâche plate acier. Carré 8 mm, entraxe 90 mm. Rappel du 1/2 tour par la clé.

Stamped steel case. Steel forend. Reversible latch without removing the case. Zinc plated alloy bolt. Steel flat striker. Square 8 mm. Draw back of the latch by key.

Caja de acero embutido. Cabeza de acero. Media vuelta reversible sin desmontar la caja. Pestillo de aleación cincada. Cerradero plano de acero. Cuadrado 8 mm. Reposición de la media vuelta con la llave.

Finition/Finish/Acabado

Zingué
Zinc coated
Cincado

Designation	Boîte	Colis.	Prix	Sachet	Colis.	Prix	Brochable					Colis.	Prix
							France	Euro 1	Euro 2	Euro 3	Euro 4		
Boîtier serrure axe 50 mm à cylindre 3 pènes Z/BR	00093657 NS	1	-	-	-	-	-	00493657 NS	-	-	-	5	-

NS Non stocké/Non-stored/Producto no estocado - Sur stock Europe Zone 1 et Zone 2, nous consulter pour délai d'approvisionnement - E Epuisement/Stock depletion/Agotamiento del stock

Axe à 50 mm / A CYLINDRE

RESIST



GARANTIE

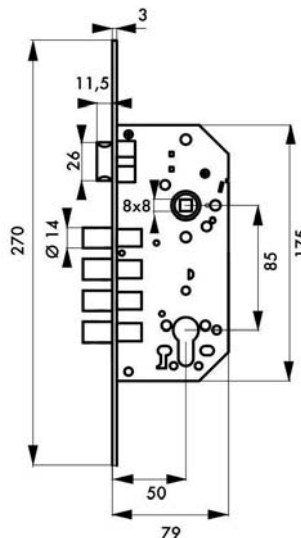

Description/Description/Descripción

Coffre acier embouti. Têtière acier bouts ronds. Demi-tour réversible sans démontage du coffre. Pêne alliage zingué. Gâche plate acier. Carré 8 mm, entr'axe 85 mm. Rappel du 1/2 tour par la clé.

Stamped steel case. Steel forend. Reversible latch without removing the case. Zinc plated alloy bolt. Steel flat striker. Square 8 mm. Draw back of the latch by key.

Caja de acero embutido. Cabeza de acero. Media vuelta reversible sin desmontar la caja. Pestillo de aleación cincada. Cerradero plano de acero. Cuadrado 8 mm. Reposición de la media vuelta con la llave.

Finition/Finish/Acabado

Têtière laitonée. Têtière nickelée. Brass plated forend. Nickel forend. Cabeza de latónado. Cabeza niquelado

Designation	Boite	Colis.	Prix	Sachet	Colis.	Prix	Brochable					Colis.	Prix
							France	Euro 1	Euro 2	Euro 3	Euro 4		
Boîtier serrure axe 50 mm à cylindre têteière laitonée - rosace fermée	00094595	1	-	-	-	-	-	-	-	00494595	-	5	-
Boîtier serrure axe 50 mm à cylindre têteière laitonée - rosace ouverte	00094596	1	-	-	-	-	-	-	-	00494596	-	5	-
Boîtier serrure axe 50 mm à cylindre têteière nickelée - rosace fermée	00094527	1	-	-	-	-	-	-	-	00494527	-	10	-
Boîtier serrure axe 50 mm à cylindre têteière nickelée - rosace ouverte	00094528	1	-	-	-	-	-	-	-	00494528	-	10	-
Rosace fermée laiton satiné	00094738	1	-	-	-	-	-	-	-	00194738	-	10	-
Rosace fermée nickelée satinée	00094739	1	-	-	-	-	-	-	-	00194739	-	10	-
Rosace ouverte laiton satiné	00094740 [E]	1	-	-	-	-	-	-	-	00194740 [E]	-	10	-
Rosace ouverte nickelée satinée	00094741 [E]	1	-	-	-	-	-	-	-	00194741 [E]	-	10	-

Axe à 50 mm / A CYLINDRE, TÊTIÈRE AFFLEURANTE RESIST



GARANTIE

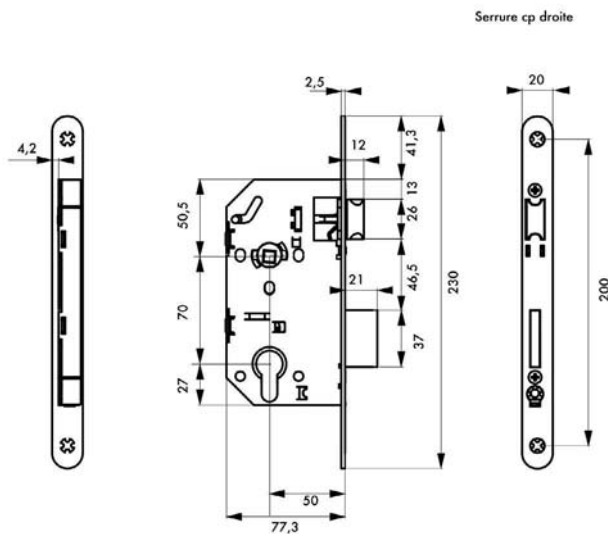

Description/Description/Descripción

Coffre acier embouti. Tête acier bouts ronds. Demi-tour bipente alliage. Pêne acier galvanisé. Gâche acier zingué. Mécanisme à 2 tours. Rappel du 1/2 tour par la clé. Carré 7 mm, entr'axe 70 mm.

Stamped steel case. Round ended steel forend. Alloy latch. Galvanised steel bolt. Zinc plated steel striker. Double deadbolt throw. Draw back of the latch by key. Square 7 mm.

Caja de acero embutido. Cabeza de extremos redondos. Media vuelta de aleación. Pestillo de acero galvanizado. Cerradero de acero cincado. Mecanismo de 2 vueltas. Reposición de la media vuelta con la llave. Cuadrado 7 mm.

Finition/Finish/Acabado

Coffre galvanisé, tête epoxy noir granité
Case galvanised, forend black epoxy

Caja galvanizado, cabeza epoxy negro

Version/Option/Versión

Possibilité carré 8 mm sur demande

Square 8 mm on request.

Cuadrado 8 mm a petición.

Designation	Boite	Colis.	Prix	Sachet	Colis.	Prix	Brochable					Colis.	Prix
							France	Euro 1	Euro 2	Euro 3	Euro 4		
Boîtier serrure axe 50mm à cylindre MONOMAX tête affleurante BR - droite	00096830	5	-	-	-	-	-	-	-	-	-	-	-
Boîtier serrure axe 50mm à cylindre MONOMAX tête affleurante BR - gauche	00096835	5	-	-	-	-	-	-	-	-	-	-	-

Non stocké/Non-stored/Producto no estocado - Sur stock Europe Zone 1 et Zone 2, nous consulter pour délai d'approvisionnement - Epuement/Stock depletion/Agotamiento del stock

Axe à 50 mm / POUR CYLINDRE, 2 TOURS

RESIST



GARANTIE



Essais selon la norme NF

EN 12209

Classification

3S400G3HC30

Caractéristiques certifiées NF :
endurance, durabilité, sécurité.

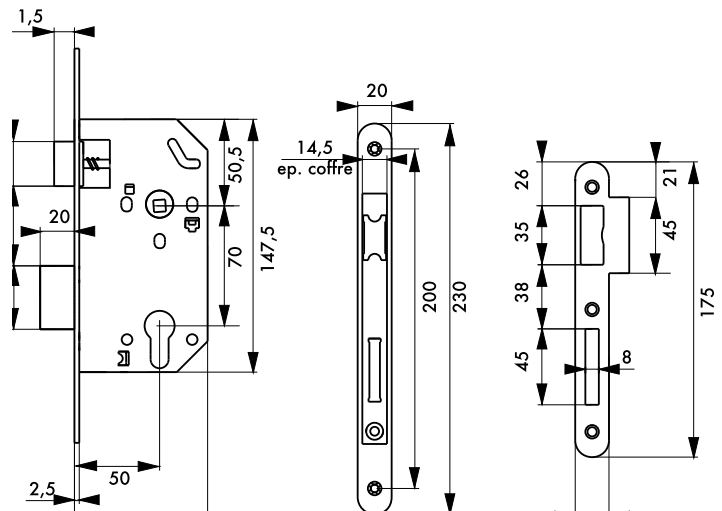

Description/Description/Descripción

Coffre acier embouti. Têtière acier bouts ronds. Demi-tour bipente alliage réversible sans démontage du coffre. Pêne acier galvanisé. Gâche plate acier zingué. Mécanisme à 2 tours. Rappel du 1/2 tour par la clé. Carré 7 mm, entr'axe 70 mm.

Stamped steel case. Round ended steel forend. Reversible alloy latch without removing the case. Galvanised steel bolt. Zinc plated steel flat striker. Double deadbolt throw. Draw back of the latch by key. Square 7 mm.

Caja de acero embutido. Cabeza de extremos redondos. Media vuelta de aleación reversible sin desmontar la caja. Pestillo de acero galvanizado. Cerradero plano de acero cincado. Mecanismo de 2 vueltas. Reposición de la media vuelta con la llave. Cuadrado 7 mm.

Finition/Finish/Acabado

Coffre galvanisé, têtère epoxy noir granité.

Case galvanised, forend black epoxy.

Caja galvanizado, cabeza epoxi negro.

Version/Option/Versión

Têtère inox, acier laitoné, acier nickelé. Possibilité carré 8 mm sur demande.

Stainless steel forend, brass plated forend, nickel plated forend. Square 8 mm on request.

Cabeza de acero inoxidable, acero latonado, acero niquelado. Cuadrado 8 mm a petición.

Axe à 50 mm / POUR CYLINDRE, 2 TOURS

RESIST

Designation	Boite	Colis.	Prix	Sachet	Colis.	Prix	Brochable					Colis.	Prix
							France	Euro 1	Euro 2	Euro 3	Euro 4		
Boîtier serrure MONOMAX NF axe 50mm à cylindre tête noire BR	00556830	5	-	00956830	20	-	00456830	-	-	-	-	5	-
Boîtier serrure MONOMAX NF axe 50mm à cylindre tête inox BR	00556831	5	-	-	-	-	00456831	-	-	-	-	5	-
Boîtier serrure MONOMAX NF axe 50mm à cylindre tête acier laitonné BR	00556832	5	-	-	-	-	-	-	-	-	-	-	-
Boîtier serrure MONOMAX NF axe 50mm à cylindre tête acier nickelé BR	00556833	5	-	-	-	-	-	-	-	-	-	-	-

Tarif conditionnement non décollable

Boîtier serrure MONOMAX NF axe 50mm à cylindre tête noire BR sans gâche (25 pièces non décollable)	00056830	25	-	-	-	-	-	-	-	-	-	-	-
Boîtier serrure MONOMAX NF axe 50mm à cylindre tête inox BR sans gâche (25 pièces non décollable)	00056831	25	-	-	-	-	-	-	-	-	-	-	-

Tarif garniture

Garniture MONOMAX axe 50 à cylindre 3 clés V/BR + ensemble ARES	00022169	30	-	-	-	-	-	-	-	-	-	-	-
Garniture MONOMAX axe 50 à cylindre 3 clés V/BR + ensemble DEMETER	00022239	30	-	-	-	-	-	-	-	-	-	-	-
Garniture MONOMAX axe 50 à cylindre 3 clés V/BR + ensemble LETO	00022179	30	-	-	-	-	-	-	-	-	-	-	-
Garniture MONOMAX axe 50 à cylindre 3 clés V/BR + ensemble VESTA	00022189	30	-	-	-	-	-	-	-	-	-	-	-
Garniture MONOMAX axe 50 à cylindre 3 clés V/BR + ensemble CHARON	00022209	30	-	-	-	-	-	-	-	-	-	-	-
Garniture MONOMAX axe 50 à cylindre 3 clés V/BR + ensemble DIONYSOS	00022199	30	-	-	-	-	-	-	-	-	-	-	-
Garniture MONOMAX axe 50 à cylindre 3 clés V/BR + ensemble DIANE	00022219	30	-	-	-	-	-	-	-	-	-	-	-
Garniture MONOMAX axe 50 à cylindre 3 clés V/BR + ensemble OURANUS	00022229	30	-	-	-	-	-	-	-	-	-	-	-
Garniture MONOMAX axe 50 à cylindre 3 clés V/BR + ensemble PELOPE	00022249	30	-	-	-	-	-	-	-	-	-	-	-
Garniture MONOMAX axe 50 à cylindre 3 clés V/BR + ensemble HERA	00022144	30	-	-	-	-	-	-	-	-	-	-	-
Garniture MONOMAX axe 50 à cylindre 3 clés V/BR + ensemble THALIA	00022154	30	-	-	-	-	-	-	-	-	-	-	-
Garniture MONOMAX axe 50 à cylindre nickelé 3 clés V/BR + ensemble HERA	00022145	30	-	-	-	-	-	-	-	-	-	-	-
Garniture MONOMAX axe 50 à cylindre nickelé 3 clés V/BR + ensemble THALIA	00022155	30	-	-	-	-	-	-	-	-	-	-	-

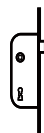

Axe à 50 mm / POUR CYLINDRE, 2 TOURS RESIST



GARANTIE

Caractéristiques certifiées NF :
endurance, durabilité, sécurité.



QC niveau 2

Spécifications dimensionnelles
selon la norme NF P 26-414
Essais selon la norme

EN 12209:2003+AC:2005

Classification

3 S 4 1 0 G 3 H C 3 0



Apte à équiper un
bloc-porte résistant
au feu

Homologation par le
laboratoire EFECTIS

Description/Description/Descripción

Coffre acier embouti galvanisé. Tête acier bouts ronds. Demi-tour bipente laiton réversible sans démontage du coffre. Pêne acier zingué - Gâche plate acier zingué. Mécanisme à 2 tours - Rappel du 1/2 tour par la clé. Carré 7 mm, entr'axe 70 mm.

Stamped steel case. Steel forend. Reversible brass latch without removing the case. Bichromated zinc plated steel bolt. Double deadbolt throw. Draw back of the latch by key. Square 7 mm.

Caja de acero embutido. Cabeza de acero. Media vuelta de latón reversible sin desmontar la caja. Pestillo de acero bicromatada. Cerradero plano de acero. Mecanismo de 2 vueltas. Reposición de la media vuelta con la llave. Cuadrado 7 mm.

Finition/Finish/Acabado

Coffre galvanisé, tête noir granité

Black epoxy

Epoxi negro granitado

Version/Option/Versión

Tête laiton. Tête nickelé. Tête inox. Possibilité carré 8 mm sur demande.

Brass plated forend. Nickel plated steel forend. Stainless steel forend.

Cabeza latonado. Cabeza acero niquelado. Cabeza acero inoxidable.

Axe à 50 mm / POUR CYLINDRE, 2 TOURS RESIST

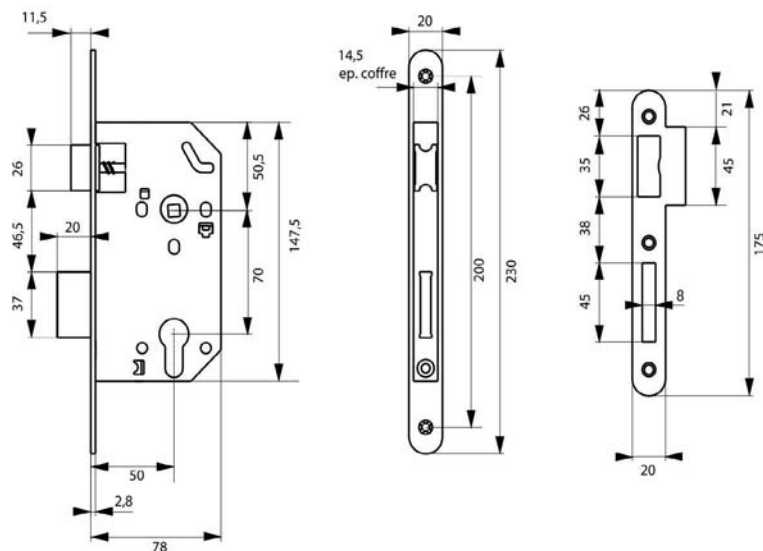

Designation	Boite	Colis.	Prix	Sachet	Colis.	Prix	Brochable					Colis.	Prix
							France	Euro 1	Euro 2	Euro 3	Euro 4		
Boîtier serrure UNIMAX CE NFQC axe 50mm à cylindre tête noire V/BR	00015206	5	-	-	-	-	00415206	-	-	-	-	10	-
Boîtier serrure UNIMAX CE NFQC axe 50mm à cylindre tête laitonée V/BR	00015236	5	-	-	-	-	-	-	-	-	-	-	-
Boîtier serrure UNIMAX CE NFQC axe 50mm à cylindre tête nickelée V/BR	00015226	5	-	-	-	-	-	-	-	-	-	-	-
Boîtier serrure UNIMAX CE NFQC axe 50mm à cylindre tête inox V/BR	00015246	5	-	-	-	-	-	-	-	-	-	-	-

Non stocké/Non-stored/Productos no estocados - Sur stock Europe Zone 1 et Zone 2, nous consulter pour délai d'approvisionnement - Epuement/Stock depletion/Agotamiento del stock

Axe à 50 mm / UNIMAX A CYLINDRE A2P *

RESIST

Caractéristiques certifiées NF : endurance, durabilité, sécurité. Pour conserver la certification. La serrure doit impérativement recevoir la sûreté HG5+, TRAN-SIT 2, ADRIATIC de marque Thirard, selon l'épaisseur de la porte.



GARANTIE



QC niveau 2

Spécifications dimensionnelles selon la norme NF P 26-414
Essais selon la norme

EN 12209

Classification

3 S 4 0 0 D 3 H C 3 0



Homologation Coupe-feu certifiée par le CSTB (Centre Scientifique et Technique du Bâtiment)

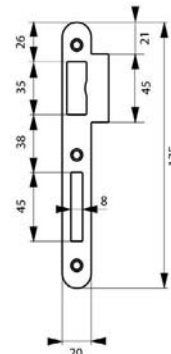
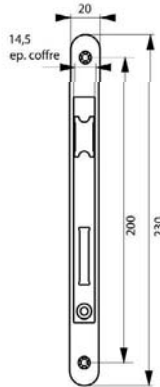
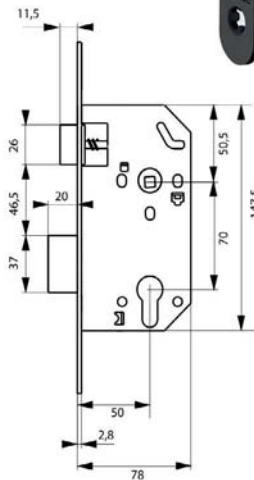

Description/Description/Descripción

Coffre acier embouti 15/10ème. Tête acier bouts ronds. Demi-tour bipente laiton réversible sans démontage du coffre. Pêne acier cémenté trempé zingué. Gâche plate acier. Mécanisme à 2 tours. Rappel du 1/2 tour par la clé. Carré 7 mm, entr'axe 70 mm. Permet le montage de toutes garnitures standard. Cylindre équipé de goupilles épaulées trempées anti crocheteur, goupille anti arrachement et protégé contre le perçage par deux aiguilles trempées. 4 clés laiton nickelé avec carte de propriété permettant la reproduction des clés en usine.

Stamped steel case 15/10th. Steel forend. Reversible brass double slope spring bolt without the need to remove the case. Hardened zinc steel bolt. Double deadbolt throw. Draw back of the latch by key. Square 7 mm. Allows use of any standard handleset. European brass profile cylinder with anti-picking hardened shouldered pins, protected against drilling by hardened needles. 4 reversible brass nickel plated keys with personal security card for key

copie.

Caja de acero embutido 15/10. Cabeza de acero redondos. Media vuelta bipendiente de latón reversible sin desmontaje de la caja. Pestillo de acero cincado. Cerradero plano de acero. Mecanismo de 2 vueltas. Reposición de la media vuelta con la llave. Cuadrado 7 mm. Cilindro equipado con pasadores reforzados templados inviolables y protegido contra el taladrado por medio de dos agujas templadas. 4 llaves de latón niquelado + tarjeta de propiedad que permite reproducir las llaves en fábrica.

Finition/Finish/Acabado

Coffre galvanisé, tête noir granité
Case galvanised, forend black epoxy
Caja galvanizado, cabeza epoxi negro

Version/Option/Versión

Tête bouts carrés, nous consulter. Possibilité carré 8 mm sur demande.

Square ended forend. Square 8 mm on request.
Square ended forend. Cuadrado 8 mm a petición.

Designation	Boite	Colis.	Prix	Sachet	Colis.	Prix	Brochable					Colis.	Prix
							France	Euro 1	Euro 2	Euro 3	Euro 4		
Serrure UNIMAX CE NFQC A2P* axe 50mm à cylindre TRANSIT 2 • 30 x 30 mm 4 clés	-	-	-	-	-	-	00411601	-	-	-	-	5	-
Boîtier serrure UNIMAX CE NFQC axe 50mm à cylindre tête noire V/BR	00011600	1	-	-	-	-	-	-	-	-	-	-	-
Cylindre HG5+ • 30 x 30 mm 4 clés	00059830	1	-	-	-	-	-	-	-	-	-	-	-
Cylindre HG5+ • 30 x 35 mm 4 clés	00059831	1	-	-	-	-	-	-	-	-	-	-	-
Cylindre HG5+ • 30 x 40 mm 4 clés	00059832	1	-	-	-	-	-	-	-	-	-	-	-
Cylindre HG5+ • 30 x 45 mm 4 clés	00059833	1	-	-	-	-	-	-	-	-	-	-	-
Cylindre HG5+ • 30 x 50 mm 4 clés	00059834	1	-	-	-	-	-	-	-	-	-	-	-
Cylindre HG5+ • 35 x 30 mm 4 clés	00059900	1	-	-	-	-	-	-	-	-	-	-	-
Cylindre HG5+ • 35 x 35 mm 4 clés	00059835	1	-	-	-	-	-	-	-	-	-	-	-
Cylindre HG5+ • 35 x 45 mm 4 clés	00059865	1	-	-	-	-	-	-	-	-	-	-	-
Cylindre HG5+ • 40 x 30 mm 4 clés	00059901	1	-	-	-	-	-	-	-	-	-	-	-
Cylindre HG5+ • 40 x 40 mm 4 clés	00059840	1	-	-	-	-	-	-	-	-	-	-	-
Cylindre HG5+ • 45 x 35 mm 4 clés	00059903	1	-	-	-	-	-	-	-	-	-	-	-
Cylindre HG5+ • 45 x 40 mm 4 clés	00059902	1	-	-	-	-	-	-	-	-	-	-	-
Cylindre HG5+ • 50 x 30 mm 4 clés	00059904	1	-	-	-	-	-	-	-	-	-	-	-
Cylindre HG5+ • 30BT x 30 mm 4 clés	00059867	1	-	-	-	-	-	-	-	-	-	-	-
Cylindre HG5+ • 30BT x 40 mm 4 clés	00059871	1	-	-	-	-	-	-	-	-	-	-	-
Cylindre HG5+ • 40BT x 30 mm 4 clés	00059891	1	-	-	-	-	-	-	-	-	-	-	-
Cylindre HG5+ • 40BT x 40 mm 4 clés	00059893	1	-	-	-	-	-	-	-	-	-	-	-
Cylindre TRANSIT 2 • 4 clés réversibles 30 x 30 mm (porte 38 à 46 mm)	00007330	1	-	-	-	-	00207330	-	-	-	-	5	-
Cylindre TRANSIT 2 • 4 clés réversibles 35 x 30 mm (porte 43 à 51 mm)	00007335	1	-	-	-	-	00207335	-	-	-	-	5	-
Cylindre TRANSIT 2 • 4 clés réversibles 40 x 30 mm (porte 48 à 56 mm)	00007340	1	-	-	-	-	00207340	-	-	-	-	5	-
Cylindre TRANSIT 2 • 4 clés réversibles 45 x 30 mm (porte 53 à 61 mm)	00007345	1	-	-	-	-	00207345	-	-	-	-	5	-
Cylindre ADRIATIC • 30 x 30 mm 4 clés	00008330 NS	1	-	-	-	-	00208330 NS	-	-	-	-	5	-
Cylindre ADRIATIC • 30 x 35 mm 4 clés	00008335 NS	1	-	-	-	-	00208335 NS	-	-	-	-	5	-
Cylindre ADRIATIC • 30 x 40 mm 4 clés	00008340 NS	1	-	-	-	-	00208340 NS	-	-	-	-	5	-
Cylindre ADRIATIC • 30 x 45 mm 4 clés	00008345 NS	1	-	-	-	-	00208345 NS	-	-	-	-	5	-

NS Non stocké/Non-stored/Productos no estocado - Sur stock Europe Zone 1 et Zone 2, nous consulter pour délai d'approvisionnement - E Epuement/Stock depletion/Agotamiento del stock

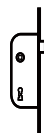

Serrure à encastrer multipoints / TRIMAX RESIST



GARANTIE



Norme NF P26-103



Homologation Coupe-feu certifiée par le CSTB (Centre Scientifique et Technique du Bâtiment)

Description/Description/Descripción

Boîtier de serrure crémone à encastrer. Verrouillage par 3 ou 5 points de condamnation. Boîtier principal acier 15/10 ème axe à 50 mm, entr'axe 70 mm. Têtière acier 18 x 3 mm zinguée. Longueur 1700, 2040, 2250. 1/2 tour bipente laiton réversible sans démontage du coffre, équerre au 1/2 tour. Pêne acier zingué 2 tours. Boîtier asservis acier 15/10 ème avec pènes zingués rectangulaire, simple rond anti-sciage ou double rond anti-sciage. Gâches acier 25/10 ème zinguées. Utilisation d'un cylindre profil européen à panneton standard normalisé DIN. Carré 7 mm.

3 or 5 point mortise lock. Main steel case 15/10th, 50 mm backset. Zinc steel forend 18 x 3 mm for 1700, 2040, or 2250 mm high reversible brass double slope spring bolt without removing the case. Zinc steel double deadbolt through up and down steel case 15/10th with rectangular or round zinc steel deadbolts. Steel flat zinc steel strikers 25/10th. Locking with european profile cylinder. Square 7 mm.

Cerradura falleba para empotrar. Cierre por 3 ó 5 puntos de condena-ción. Caja principal de acero de 15/10, eje a 50 mm, distancia entre ejes 70 mm. Cabeza de acero de 18 x 3 mm cincada. Longitud 1.700, 2.040, 2.250. Media vuelta de doble pendiente de latón reversible sin desmontar la caja, escuadra en media vuelta. Pestillo de acero cincado de 2 vueltas. Caja acoplada de acero de 15/10 con pestillos cincados rectangular, rodondo simple antiserrado o doble redondo antiserrado. Cerraderos de acero de 25/10 cincados. Utilización de un CP europeo de pivote estándar. Cuadrado 7 mm.

Finition/Finish/Acabado

Coffre et tèteière zingué

Zinc steel forend. Zinc steel cases.

Cajas acero cincado. Cabezas acero cincado

Version/Option/Versión

Entr'axe 70 mm/carré 8 mm sur demande. Entr'axe 72 mm/carré 8 mm sur demande. Conditionnement industriel sur demande.

Axis 70 mm/square 8 mm. Axis 72 mm/square 8 mm on request.

Distancia entre ejes 70 mm/cuadrado 8 mm. Distancia entre ejes 72 mm/cuadrado 8 mm a petición.

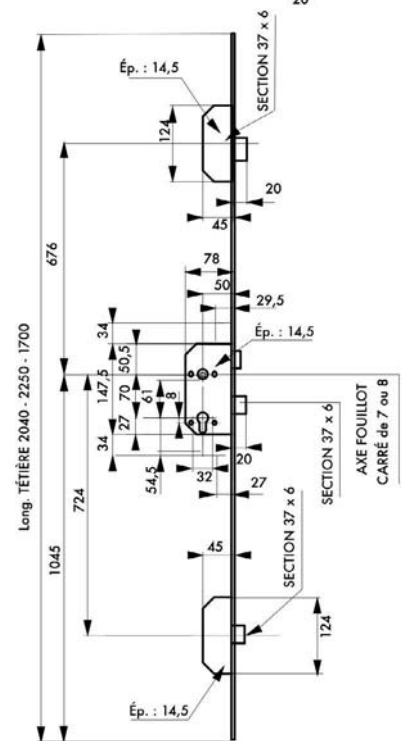
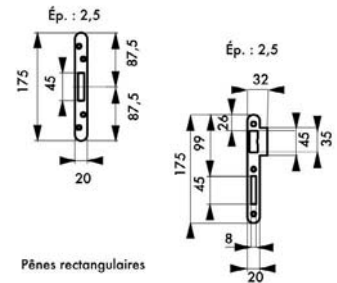

Designation	Boite	Colis.	Prix	Sachet	Colis.	Prix	Brochable					Colis.	Prix
							France	Euro 1	Euro 2	Euro 3	Euro 4		
Boîtier serrure 3 points NF QC pènes rectangulaires tèteière 1700 x 18 mm	00005619	10	-	-	-	-	-	-	-	-	-	-	-
Boîtier serrure 3 points NF QC pènes rectangulaires en saillie de 3mm tèteière 1700 x 18mm	00001600	10	-	-	-	-	-	-	-	-	-	-	-

NS Non stocké/Non-stored/Producto no estocado - S Sur stock Europe Zone 1 et Zone 2, nous consulter pour délai d'approvisionnement - E Epuisement/Stock depletion/Agotamiento del stock

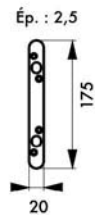
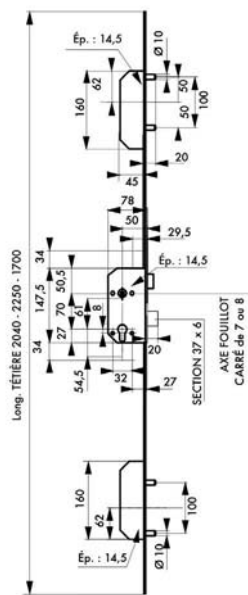

Serrure coupe-feu certifiée
par les organismes officiels

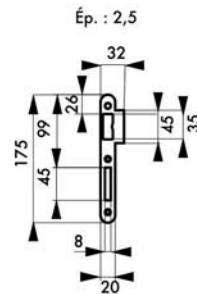

Designation	Boîte	Colis.	Prix	Sachet	Colis.	Prix	Brochable					Colis.	Prix
							France	Euro 1	Euro 2	Euro 3	Euro 4		
Boîtier serrure 3 points NF QC pènes rectangulaires tête 2040 x 18 mm	00000619	10	-	-	-	-	-	-	-	-	-	-	-
Boîtier serrure 3 points NF QC pènes rectangulaires tête 2040 x 18 mm avec 3 gâches	00010619	10	-	-	-	-	-	-	-	-	-	-	-
Boîtier serrure 3 points NF QC pènes rectangulaires tête 2250 x 18 mm	00008619	10	-	-	-	-	-	-	-	-	-	-	-
Boîtier serrure 5 points NF QC à 2 X 2 pènes ronds en saillie 3mm tête 1700 x 18 mm	00001700	10	-	-	-	-	-	-	-	-	-	-	-
Boîtier serrure 5 points NF QC à 2 X 2 pènes ronds tête 2040 x 18 mm	00000707	10	-	-	-	-	-	-	-	-	-	-	-
Boîtier serrure 5 points NF QC à 2 X 2 pènes ronds tête 2250 x 18 mm	00008707	10	-	-	-	-	-	-	-	-	-	-	-
Lot de gâches plates 20 mm bouts carrés (3 pènes rectangulaires)	00090619	10	-	-	-	-	00490619	-	-	-	-	10	-
Lot de gâches plates 20 mm bouts ronds (3 pènes rectangulaires)	00091619	10	-	-	-	-	00491619	-	-	-	-	10	-
Lot de gâches plates 20 mm bouts carrés (double pènes ronds Ø 10)	00089619	10	-	-	-	-	00489619	-	-	-	-	10	-
Lot de gâches plates 20 mm bouts ronds (double pènes ronds Ø 10)	00088619	10	-	-	-	-	00488619	-	-	-	-	10	-
Lot de gâches équerre 20 x 20 mm	00096619	10	-	-	-	-	00496619	-	-	-	-	10	-

Tarif conditionnement non décolisable

Boîtier serrure 3 points NF QC pènes rectangulaires tête 2040 x 18 mm (15 pièces non décolisable)	00009619	15	-	-	-	-	-	-	-	-	-	-	-
---	----------	----	---	---	---	---	---	---	---	---	---	---	---

☐ Non stocké/Non-stored/Producto no estocado - ☑ Sur stock Europe Zone 1 et Zone 2, nous consulter pour délai d'approvisionnement - ☒ Epuisement/Stock depletion/Agotamiento del stock



Serrure à encastrer multipoints / TRIMAX A2P*

RESIST

Caractéristiques certifiées NF : endurance, durabilité, sécurité.
 Pour conserver la certification A2P*, la serrure doit impérativement recevoir la sûreté HG5+, TRANSIT 2, ADRIATIC de marque Thirard selon l'épaisseur de la porte.



QC Norme NF P26-103



Homologation Coupe-feu certifiée par le CSTB (Centre Scientifique et Technique du Batiment)



GARANTIE



Description/Description/Descripción

Serrure crémone à encastrer. Verrouillage par 3 ou 5 points de condamnation. Boîtier principal acier 15/10 ème axe à 50 mm, entr'axe 70 mm. Têtière acier 18 x 3 mm zinguée, longueur 2040. 1/2 tour bipente laiton réversible sans démontage du coffre, équerre au 1/2 tour. Pêne central en acier cémenté trempé, zingué, 2 tours. Boîtier asservis acier 15/10 ème avec pènes zingués rectangulaire ou double rond anti-sciage. Gâches acier 25/10 ème zinguées. Carré 7 mm.

3 or 5 point mortise lock. Main steel case 15/10th, 50 mm backset, axis 70 mm. Zinc steel forend. 18 x 3 mm for 2040 mm high. Reversible brass double slope spring bolt without removing the case. Zinc steel double deadbolt through up and down. Steel case 15/10th with rectangular or double round zinc steel deadbolts. Steel flat zinc steel strickers 25/10th. Square 7 mm. Delivered with double zinc alloy modulen anti sawing hardened steel pins, anti drilling pins. Profile cylinder with anti drilling pins. Hardened steel deadbolt. Allow to use any standard handleset. 4 reversibles keys with a personal security card for key copies.
 Cerradura falleba para empotrar. Cierre por 3 ó 5 puntos de condenación. Caja principal de acero de 15/10, eje a 50 m, distancia entre ejes 70 mm. Cabeza de acero de 18 x 3 mm cincada. Longitud 2.040 mm. Media vuelta de doble pendiente de latón reversible sin desmontar la caja, escuadra en media vuelta. Pestillo de acero cincado de 2 vueltas. Caja acoplada de acero de 15/10 con pestillos cincados rectangular o doble redondo anti-serrado. Cerraderos de acero de 25/10 cincados. Cuadrado 7 mm. Equipada con un módulo de protección de aleación moldeada en dos partes con pasadores anti-serrado. Cilindro equipado con pasadores reforzados templados inviolables y protegido contra el taladrado por medio de dos agujas templadas y pasadores antiarrancamiento. Pestillo central de acero cementado templado. Permite montar todo tipo de guarniciones estándar. 4 llaves planas reversibles con tarjeta de propiedad para la reproducción de las llaves en fábrica

Finition/Finish/Acabado

Coffre et tèteière zingué

Zinc steel forend. Zinc steel cases.

Cajas acero cincado. Cabezas acero cincado.

Version/Option/Versión

Pènes en saillie de 3 mm : réf. 001600 - 001700. Entr'axe 70 mm/carré 8 mm sur demande. Entr'axe 72 mm/carré 8 mm sur demande. Conditionnement industriel sur demande.

Bolt 3 mm projection : ref 001600 - 001700. Axis 70 mm/square 8 mm. Axis 72 mm/square 8 mm on request.

Pestillo en saillie de 3 mm : ref 001600 - 001700. Distancia entre ejes 70 mm/cuadrado 8 mm. Distancia entre ejes 72 mm/cuadrado 8 mm a petición.

Designation	Boite	Colis.	Prix	Sachet	Colis.	Prix	Brochable					Colis.	Prix
							France	Euro 1	Euro 2	Euro 3	Euro 4		
Boîtier serrure 3 points NF QC pènes rectangulaires tèteière 2040 x 18 mm A2P *	00000600	10	-	-	-	-	-	-	-	-	-	-	-
Boîtier serrure 5 points NF QC à 2 X 2 pènes ronds tèteière 2040 x 18 mm A2P *	00000700	10	-	-	-	-	-	-	-	-	-	-	-
Cylindre HG5+ • 30 x 30 mm 4 clés	00059830	1	-	-	-	-	-	-	-	-	-	-	-
Cylindre HG5+ • 30 x 35 mm 4 clés	00059831	1	-	-	-	-	-	-	-	-	-	-	-
Cylindre HG5+ • 30 x 40 mm 4 clés	00059832	1	-	-	-	-	-	-	-	-	-	-	-
Cylindre HG5+ • 30 x 45 mm 4 clés	00059833	1	-	-	-	-	-	-	-	-	-	-	-

Non stocké/Non-stored/Producto no estocado - Sur stock Europe Zone 1 et Zone 2, nous consulter pour délai d'approvisionnement - Eupisement/Stock depletion/Agotamiento del stock

Designation	Boite	Colis.	Prix	Sachet	Colis.	Prix	Brochable					Colis.	Prix
							France	Euro 1	Euro 2	Euro 3	Euro 4		
Cylindre HG5+ • 30 x 50 mm 4 clés	00059834	1	-	-	-	-	-	-	-	-	-	-	-
Cylindre HG5+ • 35 x 30 mm 4 clés	00059900	1	-	-	-	-	-	-	-	-	-	-	-
Cylindre HG5+ • 35 x 35 mm 4 clés	00059835	1	-	-	-	-	-	-	-	-	-	-	-
Cylindre HG5+ • 35 x 45 mm 4 clés	00059865	1	-	-	-	-	-	-	-	-	-	-	-
Cylindre HG5+ • 40 x 30 mm 4 clés	00059901	1	-	-	-	-	-	-	-	-	-	-	-
Cylindre HG5+ • 40 x 40 mm 4 clés	00059840	1	-	-	-	-	-	-	-	-	-	-	-
Cylindre HG5+ • 45 x 35 mm 4 clés	00059903	1	-	-	-	-	-	-	-	-	-	-	-
Cylindre HG5+ • 45 x 40 mm 4 clés	00059902	1	-	-	-	-	-	-	-	-	-	-	-
Cylindre HG5+ • 50 x 30 mm 4 clés	00059904	1	-	-	-	-	-	-	-	-	-	-	-
Cylindre HG5+ • 30BT x 30 mm 4 clés	00059867	1	-	-	-	-	-	-	-	-	-	-	-
Cylindre HG5+ • 30BT x 40 mm 4 clés	00059871	1	-	-	-	-	-	-	-	-	-	-	-
Cylindre HG5+ • 40BT x 30 mm 4 clés	00059891	1	-	-	-	-	-	-	-	-	-	-	-
Cylindre HG5+ • 40BT x 40 mm 4 clés	00059893	1	-	-	-	-	-	-	-	-	-	-	-
Cylindre TRANSIT 2 • 4 clés réversibles 30 x 30 mm (porte 38 à 46 mm)	00007330	1	-	-	-	-	00207330	-	-	-	-	5	-
Cylindre TRANSIT 2 • 4 clés réversibles 35 x 30 mm (porte 43 à 51 mm)	00007335	1	-	-	-	-	00207335	-	-	-	-	5	-
Cylindre TRANSIT 2 • 4 clés réversibles 40 x 30 mm (porte 48 à 56 mm)	00007340	1	-	-	-	-	00207340	-	-	-	-	5	-
Cylindre TRANSIT 2 • 4 clés réversibles 45 x 30 mm (porte 53 à 61 mm)	00007345	1	-	-	-	-	00207345	-	-	-	-	5	-
Cylindre ADRIATIC • 30 x 30 mm 4 clés	00008330 NS	1	-	-	-	-	00208330 NS	-	-	-	-	5	-
Cylindre ADRIATIC • 30 x 35 mm 4 clés	00008335 NS	1	-	-	-	-	00208335 NS	-	-	-	-	5	-
Cylindre ADRIATIC • 30 x 40 mm 4 clés	00008340 NS	1	-	-	-	-	00208340 NS	-	-	-	-	5	-
Cylindre ADRIATIC • 30 x 45 mm 4 clés	00008345 NS	1	-	-	-	-	00208345 NS	-	-	-	-	5	-
Lot de gâches plates 20 mm bouts carrés (3 pènes rectangulaires)	00090619	10	-	-	-	-	00490619	-	-	-	-	10	-
Lot de gâches plates 20 mm bouts ronds (3 pènes rectangulaires)	00091619	10	-	-	-	-	00491619	-	-	-	-	10	-
Lot de gâches plates 20 mm bouts carrés (double pènes ronds Ø 10)	00089619	10	-	-	-	-	00489619	-	-	-	-	10	-
Lot de gâches plates 20 mm bouts ronds (double pènes ronds Ø 10)	00088619	10	-	-	-	-	00488619	-	-	-	-	10	-
Lot de gâches équerre 20 x 20 mm	00096619	10	-	-	-	-	00496619	-	-	-	-	10	-

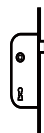

Serrure à encastrer multipoints / TRIMAX A2P *

RESIST

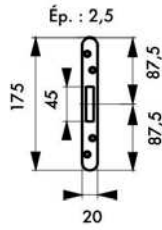

Pênes rectangulaires

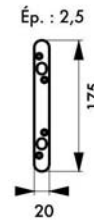

Pênes ronds

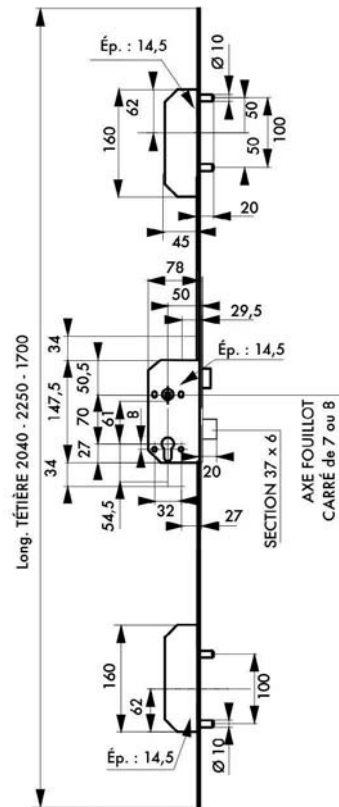
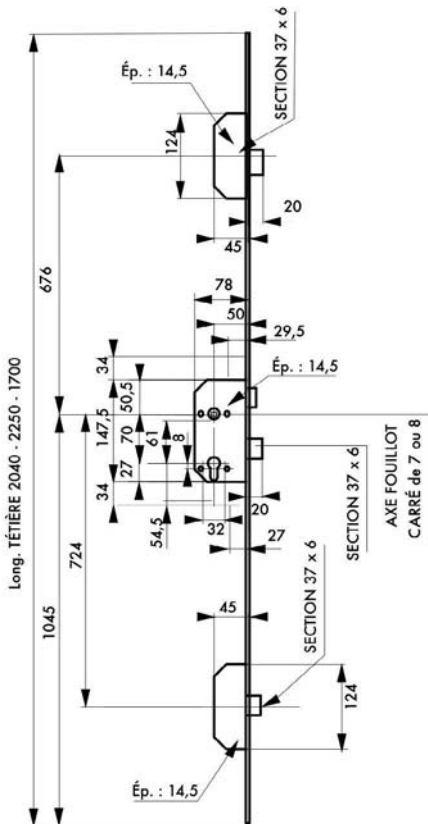
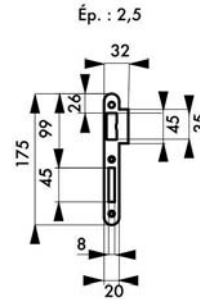
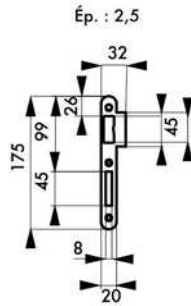

Axe à 50 mm / POUR CYLINDRE, 2 TOURS RESIST



GARANTIE

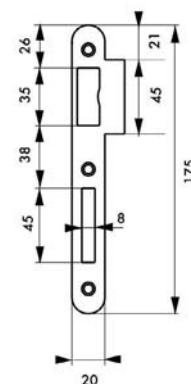
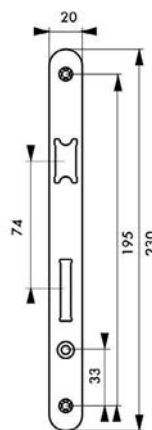
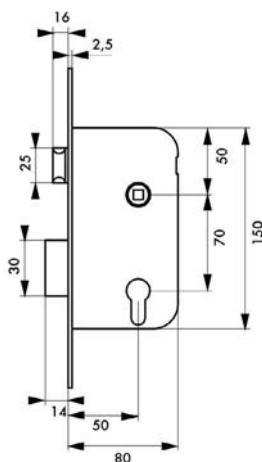

Description/Description/Descripción

Coffre inox embouti. Tête inox. Demi-tour inox. Ouverture à droite. Pêne inox. Gâche plate inox. Mécanisme à 1 tour. Carré 8 mm, entr'axe 70 mm. Sans rappel du 1/2 tour par la clé.

Stamped stainless steel case. Stainless steel forend. Reversible bichromated zinc plated alloy latch without removing the case. Bichromated zinc plated alloy bolt. Stainless steel flat striker. Double deadbolt throw. Draw back of the latch by key. Square 8 mm. Without draw back of the latch by key.

Caja de acero inoxidable embutido. Cabeza de acero inoxidable. Media vuelta de aleación bicromatada reversible sin desmontar la caja. Pestillo de aleación bicromatada. Cerradero plano de acero inoxidable. Mecanismo de 2 vueltas. Cuadrado 8 mm. No reposición de la media vuelta con la llave

Finition/Finish/Acabado

Tête inox
Stainless steel forend
Cabeza de acero inoxidable

Version/Option/Versión

Droite
Right hand
Derecha

Designation	Boîte	Colis.	Prix	Sachet	Colis.	Prix	Brochable					Colis.	Prix
							France	Euro 1	Euro 2	Euro 3	Euro 4		
Boîtier serrure axe 50mm à cylindre tout inox - droite	00003996	5	-	-	-	-	00403996	-	-	-	-	5	-

Non stocké/Non-stored/Producto no estocado - Sur stock Europe Zone 1 et Zone 2, nous consulter pour délai d'approvisionnement - Epuisement/Stock depletion/Agotamiento del stock

Axe à 55 mm / «ALSACE» PROTECT



GARANTIE

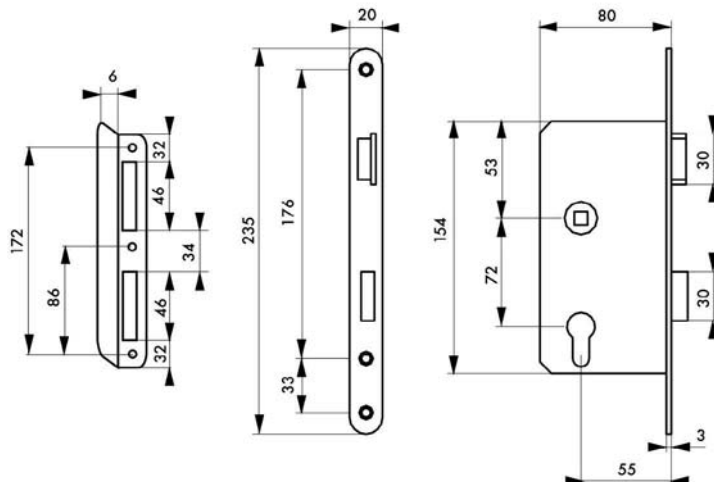

Description/Description/Descripción

Coffre acier cambré. Têtière acier bouts ronds. Demi-tour alliage. Fouillot polyamide. Pêne alliage. Mécanisme à 2 tours avec rappel du 1/2 tour par la clé. Carré 8 mm. Gâche équerre acier.(Demi-tour et pêne zamak : réf. 055006, 055016).

Cambered steel case. Round ended steel forend. Alloy latch, Polyamid follower. Alloy bolt. Double latch mechanism with draw back of the latch by key. Square 8 mm. Angle steel striker. (Zamak latch and bolt : ref. 055006, 055016)

Caja de acero curvado. Cabeza de acero de extremos redondos. Media vuelta de aleación. Nuez de poliamida. Pestillo de aleación. Mecanismo de 2 vueltas con reposición de la media vuelta con la llave. Cuadrado 8 mm. Cerradero escuadra de acero. (Media vuelta y pestillo zamak : ref. 055006, 055016)

Finition/Finish/Acabado

Têtière vernie - Coffre zingué
Varnished forend - Zinc plated case
Cabeza barnizada - Caja cincada

Version/Option/Versión

Droite ou gauche
Right or left hand
Derecha o izquierda

Designation	Boîte	Colis.	Prix	Sachet	Colis.	Prix	Brochable					Colis.	Prix
							France	Euro 1	Euro 2	Euro 3	Euro 4		
Boîtier serrure axe 55mm à cylindre, entr'axes 72 mm - droite	00055006	1	-	00955006	20	-	00455006	00493229 NS	00492229 NS	00494229	-	5	-
Boîtier serrure axe 55mm à cylindre, entr'axes 72 mm - gauche	00055016	1	-	00955016	20	-	00455016	00493230 NS	00492230 NS	00494230	-	5	-
Gâche pour serrure à encastrer	00055000	10	-	-	-	-	-	-	-	-	-	-	-

NS Non stocké/Non-stored/Producto no estocado - ☐ Sur stock Europe Zone 1 et Zone 2, nous consulter pour délai d'approvisionnement - E Epuisement/Stock depletion/Agotamiento del stock

Axe à 55 mm / A CYLINDRE RESIST



GARANTIE



X 3

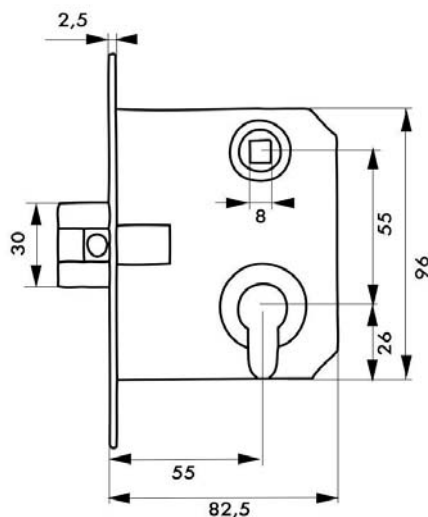

Description/Description/Descripción

Coffre acier embouti. Têtière acier bouts ronds. Réversible. Pêne alliage zingué . Gâche équerre acier. Carré 8 mm, entraxe 55 mm.

Stamped steel case. Steel forend. Reversible. Zinc plated alloy bolt. Angle steel striker. Square 8 mm.

Caja de acero embutido. Cabeza de acero. Reversible. Pestillo de aleación cincada . Cerradero escuadra de acero. Cuadrado 8 mm.

Finition/Finish/Acabado

Zingué
Zinc coated
Cincado

Designation	Boîte	Colis.	Prix	Sachet	Colis.	Prix	Brochable					Colis.	Prix
							France	Euro 1	Euro 2	Euro 3	Euro 4		
Boîtier serrure axe 55mm à cylindre, entr'axes 55 mm	-	-	-	-	-	-	-	-	00492312 NS	-	-	5	-
Serrure axe 55mm à cylindre profilé, entr'axes 55 mm - 3 clés	-	-	-	-	-	-	-	-	00492593 NS	-	-	5	-

NS Non stocké/Non-stored/Producto no estocado - □ Sur stock Europe Zone 1 et Zone 2, nous consulter pour délai d'approvisionnement - E Epuisement/Stock depletion/Agotamiento del stock

Axe à 60 mm / A CYLINDRE RESIST



GARANTIE

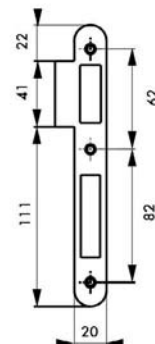
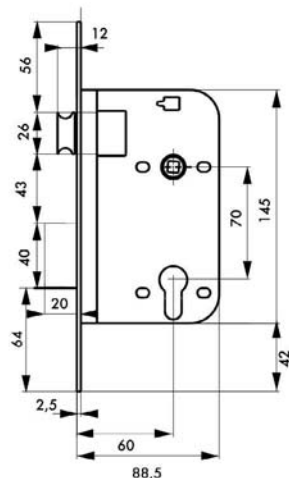

Description/Description/Descripción

Coffre acier embouti. Têtière laiton. 1/2 tour laiton réversible sans démontage du coffre. Pêne laiton. Rappel du 1/2 tour par la clé. Carré 7 mm, entr'axe 70 mm. Gâche plate selon finition.

Stamped steel case. Brass forend. Reversible brass latch without removing the case. Brass bolt. Draw back of the latch by key. Square 7 mm. Flat striker.

Caja de acero embutido. Cabeza de latón. Media vuelta de latón reversible. sin desmontar la caja. Pestillo de latón. Reposición de la media vuelta con la llave. Cuadrado 7 mm. Cerradero plano.

Finition/Finish/Acabado

Têtière laiton brossé. Têtière laiton poli verni. Têtière nickelée. Têtière noire.

Brushed brass forend - Black forend Polished brass forend - Nickel forend

Cabeza de latón cepillado. Cabeza de latón pulido barnizado. Cabeza niquelada - Cabeza negro

Version/Option/Versión

Bec de cane. A condamnation

Without key. With locking for bathroom

Resbalón - De condenación

Designation	Boite	Colis.	Prix	Sachet	Colis.	Prix	Brochable					Colis.	Prix
							France	Euro 1	Euro 2	Euro 3	Euro 4		
Boîtier serrure axe 60mm à cylindre têtère laiton brossé V/BR/L	00009306	5	-	-	-	-	-	-	-	-	-	-	-
Boîtier serrure axe 60mm à cylindre têtère laiton poli verni V/BR/L	00019306	5	-	-	-	-	-	-	-	-	-	-	-
Boîtier serrure axe 60mm à cylindre têtère nickelée V/BR/L	00019396	5	-	-	-	-	-	-	-	-	-	-	-
Boîtier serrure axe 60mm à cylindre têtère noire V/BR/L	00019356	5	-	-	-	-	-	-	-	-	-	-	-

NS Non stocké/Non-stored/Producto no estocado - ☐ Sur stock Europe Zone 1 et Zone 2, nous consulter pour délai d'approvisionnement - ☒ Epuisement/Stock depletion/Agotamiento del stock

Axe à 60 mm / A CYLINDRE RESIST

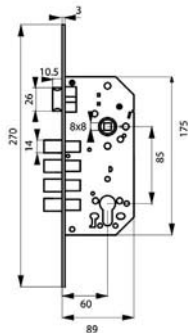

GARANTIE

Description/Description/Descripción

Coffre acier embouti. Têtière acier bouts ronds. Demi-tour réversible sans démontage du coffre. Pêne alliage zingué. Gâche plate acier. Carré 8 mm, entraxe 85 mm. Rappel du 1/2 tour par la clé.

Stamped steel case. Steel forend. Reversible latch without removing the case. Zinc plated alloy bolt. Steel flat striker. Square 8 mm. Draw back of the latch by key.

Caja de acero embutido. Cabeza de acero. Media vuelta

reversible sin desmontar la caja. Pestillo de aleación cincada. Cerradero plano de acero. Cuadrado 8 mm. Reposición de la media vuelta con la llave.

Finition/Finish/Acabado

Zingué. Têtière laitonée. Têtière nickelée. Zinc coated. Brass plated forend. Nickel forend. Cincado. Cabeza de latónado. Cabeza niquelado.

Designation	Boite	Colis.	Prix	Sachet	Colis.	Prix	Brochable					Colis.	Prix
							France	Euro 1	Euro 2	Euro 3	Euro 4		
Boîtier serrure axe 60mm à cylindre 4 pènes têtère laitonée	00094326	1	-	-	-	-	-	-	-	00494326	-	5	-
Boîtier serrure axe 60mm à cylindre 4 pènes têtère nickelée	00094521	1	-	-	-	-	-	-	-	00494521	-	5	-

Axe à 60 mm / À CYLINDRE RESIST

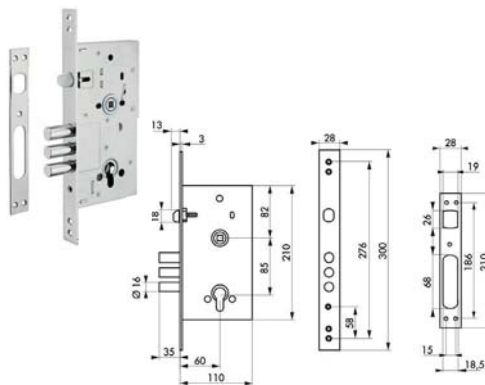
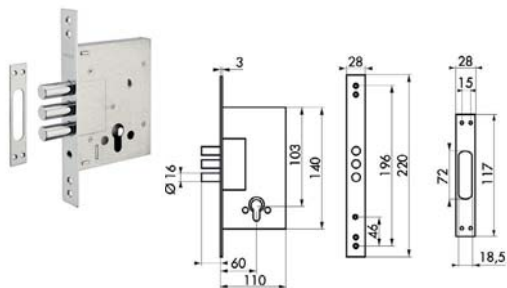

GARANTIE

Description/Description/Descripción

Coffre acier embouti. Têtière acier bouts carrés. Demi-tour réversible sans démontage du coffre. Pêne acier nickelé. Gâche plate acier. Carré 8 mm, entraxe 85 mm. Stamped steel case. Steel forend. Reversible latch without removing the case. Nickel plated steel bolt. Steel flat striker. Square 8 mm.

Caja de acero embutido. Cabeza de acero. Media vuelta

reversible sin desmontar la caja. Pestillo de acero niquelado. Cerradero plano de acero. Cuadrado 8 mm

Finition/Finish/Acabado

Têtière nickelée. Nickel forend. Cabeza niquelado

Designation	Boite	Colis.	Prix	Sachet	Colis.	Prix	Brochable					Colis.	Prix
							France	Euro 1	Euro 2	Euro 3	Euro 4		
Boîtier serrure axe 60mm à cylindre 3 pènes	-	-	-	00992738 NS	10	-	-	-	00492701 NS	-	-	5	-
Boîtier serrure axe 60mm à cylindre 3 pènes dormants seuls	-	-	-	00992739 NS	10	-	-	-	00492702 NS	-	-	5	-

NS Non stocké/Non-stored/Producto no estocado - Sur stock Europe Zone 1 et Zone 2, nous consulter pour délai d'approvisionnement - E Epuisement/Stock depletion/Agotamiento del stock

Axe à 60 mm / À CYLINDRE RESIST



GARANTIE

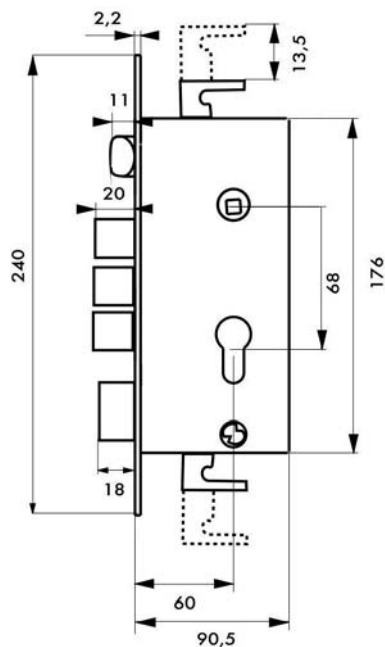

Description/Description/Descripción

Coffre acier embouti. Tête à acier bouts carrés. Demi-tour réversible sans démontage du coffre. Pêne alliage zingué. Gâche plate acier. Carré 8 mm, entraxe 68 mm. Rappel du 1/2 tour par la clé.

Stamped steel case. Steel forend. Reversible latch without removing the case. Zinc plated alloy bolt. Steel flat striker. Square 8 mm. Draw back of the latch by key.

Caja de acero embutido. Cabeza de acero. Media vuelta reversible sin desmontar la caja. Pestillo de aleación cincada. Cerradero plano de acero. Cuadrado 8 mm. Reposición de la media vuelta con la llave.

Finition/Finish/Acabado

Tête à nickelée

Nickel forend

Cabeza niquelada

Designation	Boite	Colis.	Prix	Sachet	Colis.	Prix	Brochable					Colis.	Prix
							France	Euro 1	Euro 2	Euro 3	Euro 4		
Boîtier serrure axe 60mm à cylindre tête à nickelée	00094326	1	-	-	-	-	00494326	-	00592536	-	-	5	-

⚠ Non stocké/Non-stored/Producto no estocado - 📦 Sur stock Europe Zone 1 et Zone 2, nous consulter pour délai d'approvisionnement - 📦 Epuisement/Stock depletion/Agotamiento del stock

Axe à 60 mm / À CYLINDRE RESIST

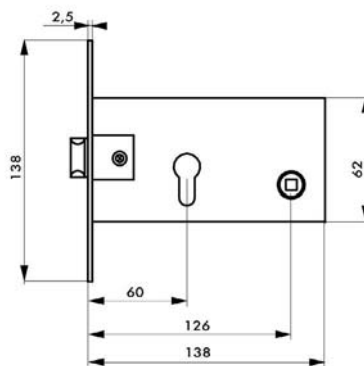

GARANTIE

Description/Description/Descripción

Coffre acier embouti épaisseur 12 mm. Tête acier bouts Carrés. Demi-tour réversible sans démontage du coffre. Pêne alliage zingué . Gâche plate acier. Carré 8 mm, entr'axe 66 mm.

Stamped steel case thickness 12 mm.. Steel forend. Reversible latch without removing the case. Zinc plated alloy bolt. Steel flat striker. Square 8 mm.

Caja de acero embutido espesor 12 mm.

Cabeza de acero. Media vuelta reversible sin desmontar la caja. Pestillo de aleación cincada . Cerradero plano de acero. Cuadrado 8 mm.

Finition/Finish/Acabado

Tête nickelée

Nickel forend

Cabeza niquelado

Designation	Boite	Colis.	Prix	Sachet	Colis.	Prix	Brochable				Colis.	Prix	
							France	Euro 1	Euro 2	Euro 3			Euro 4
Boîtier serrure axe 60mm à cylindre tête nickelée	00094373	1	-	-	-	-	-	-	-	00494373	-	5	-

Axe à 67 mm / A CYLINDRE RESIST

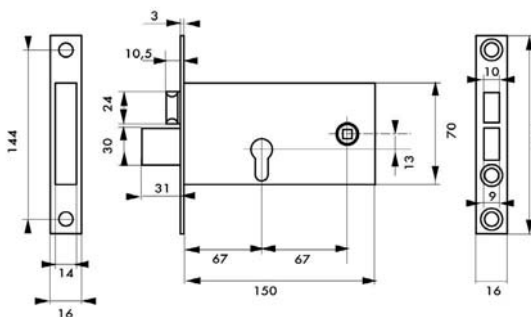

GARANTIE

Description/Description/Descripción

Coffre acier zingué plastifié. Tête inox largeur 16mm. Demi-tour laiton réversible. Pêne acier nickelé. Carré 8 mm laiton, entr'axe 67 mm. Livrée sans gâche.

Zinc and plastic plated steel case. Stainless steel forend 16mm wide. Reversible nickel plated brass latch bolt. Nickel plated steel dead bolt. Square 8 mm brass. Delivered without striker.

Caja de acero galvanizado recubierto de plástico. Cabeza

de acero inoxidable 16mm de ancho. Media vuelta de latón.Reversible. Pestillo de acero niquelado.Cuadrado 8 mm latón. Entregada sin cerradero.

Finition/Finish/Acabado

Tête inox

Stainless steel forend

Cabeza de acero inoxidable

Designation	Boite	Colis.	Prix	Sachet	Colis.	Prix	Brochable				Colis.	Prix	
							France	Euro 1	Euro 2	Euro 3			Euro 4
Boîtier serrure axe 67mm à cylindre tête inox largeur 16mm	00013916	5	-	-	-	-	-	-	-	-	-	-	-

Non stocké/Non-stored/Producto no estocado - Sur stock Europe Zone 1 et Zone 2, nous consulter pour délai d'approvisionnement - Epuisement/Stock depletion/Agotamiento del stock

Axe à 67 mm / A CYLINDRE RESIST



GARANTIE

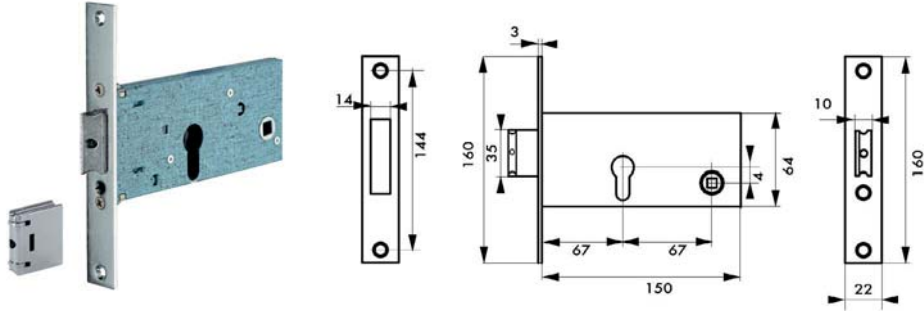

Description/Description/Descripción

Coffre acier zingué plastifié. Têtière acier nickelé chromé largeur 22mm. Demi-tour alliage nickelé réversible. Interchangeable avec pêne à rouleau. Carré 8 mm, entr'axe 67 mm.

Zinc and plastic plated steel case. Nickel and chromium plated steel forend 22mm wide. Reversible nickel plated alloy latch bolt. Interchangeable into roller bolt. Square 8 mm.

Caja de acero galvanizado recubierto de plástico. Cabeza de acero cromado 22mm de ancho. Media vuelta de aleación cincada niquelada. Reversible. Posibilidad de montaje con rodillo. Cuadrado 8 mm.

Finition/Finish/Acabado

Têtière nickelée
Nickel forend
Cabeza niquelada

Designation	Boite	Colis.	Prix	Sachet	Colis.	Prix	Brochable					Colis.	Prix
							France	Euro 1	Euro 2	Euro 3	Euro 4		
Boîtier serrure axe 67mm à cylindre tête nickelée largeur 22mm	00013918	5	-	-	-	-	-	-	-	-	-	-	-

Axe à 67 mm / A CYLINDRE RESIST



GARANTIE

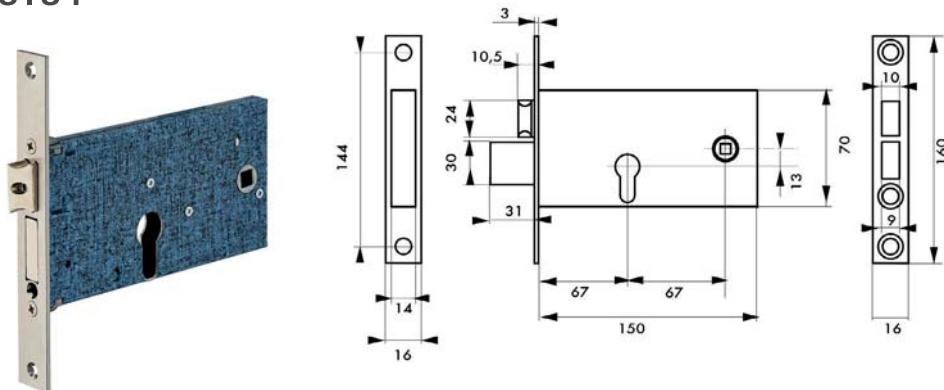

Description/Description/Descripción

Coffre acier zingué plastifié. Têtière inox largeur 22mm. Demi-tour laiton réversible. Carré 8 mm, entr'axe 67 mm. Livrée sans gâche.

Zinc and plastic plated steel case. Stainless steel forend 22mm wide. Reversible nickel plated brass latch bolt. Square 8 mm. Delivered without striker.

Caja de acero galvanizado recubierto de plástico. Cabeza

de acero inoxidable 22mm de ancho. Media vuelta de latón. Reversible. Cuadrado 8 mm. Entregada sin cerradero.

Finition/Finish/Acabado

Têtière inox
Stainless steel forend
Cabeza de acero inoxidable.

Designation	Boite	Colis.	Prix	Sachet	Colis.	Prix	Brochable					Colis.	Prix
							France	Euro 1	Euro 2	Euro 3	Euro 4		
Boîtier serrure axe 67mm à cylindre tête inox largeur 22mm	00013917	5	-	-	-	-	-	-	-	-	-	-	-

⚠ Non stocké/Non-stored/Producto no estocado - 📦 Sur stock Europe Zone 1 et Zone 2, nous consulter pour délai d'approvisionnement - 📦 Epuisement/Stock depletion/Agotamiento del stock

Axe à 70 mm / A CYLINDRE PROTECT



GARANTIE

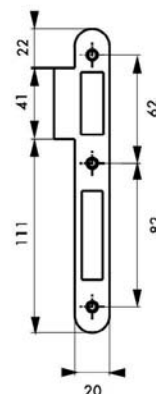
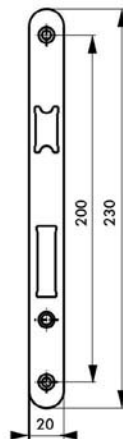
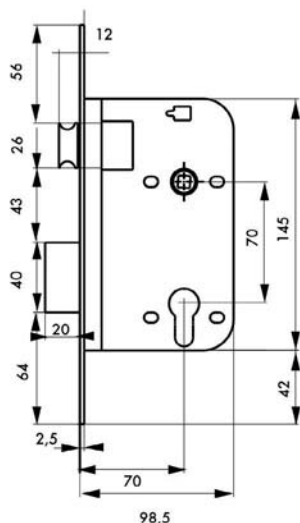

Description/Description/Descripción

Coffre acier embouti. Têtière laiton. 1/2 tour laiton réversible sans démontage du coffre. Pêne laiton. Rappel du 1/2 tour par la clé. Carré 7 mm, entr'axe 70 mm. Gâche plate selon finition.

Stamped steel case. Brass forend. Reversible brass latch without removing the case. Brass bolt. Draw back of the latch by key. Square 7 mm. Flat striker.

Caja de acero embutido. Cabeza de latón. Media vuelta de latón reversible. sin desmontar la caja. Pestillo de latón. Reposición de la media vuelta con la llave. Cuadrado 7 mm. Cerradero plano.

Finition/Finish/Acabado

Epoxy noir. Têtière laiton brossé. Têtière laiton poli verni. Têtière nickelé. Têtière noire.

Black epoxy. Brushsed brass forend - Black forend Polished brass forend - Nickel forend

Epoxi negro. Cabeza de latón cepillado. Cabeza de latón pulido barnizado. Cabeza niquelada - Cabeza negro

Designation	Boite	Colis.	Prix	Sachet	Colis.	Prix	Brochable					Colis.	Prix
							France	Euro 1	Euro 2	Euro 3	Euro 4		
Boîtier serrure axe 70mm à cylindre têteière laiton brossé V/BR/L	00007206	5	-	-	-	-	-	-	-	-	-	-	-
Boîtier serrure axe 70mm à cylindre têteière laiton poli V/BR/L	00007296	5	-	-	-	-	-	-	-	-	-	-	-
Boîtier serrure axe 70mm à cylindre têteière nickelé V/BR/L	00017296	5	-	-	-	-	-	-	-	-	-	-	-
Boîtier serrure axe 70mm à cylindre têteière noire V/BR/L	00017256	5	-	-	-	-	-	-	-	-	-	-	-

⊗ Non stocké/Non-stored/Producto no estocado - ⊗ Sur stock Europe Zone 1 et Zone 2, nous consulter pour délai d'approvisionnement - ⊗ Epuisement/Stock depletion/Agotamiento del stock

Axe à 70 mm / A CYLINDRE RESIST



GARANTIE

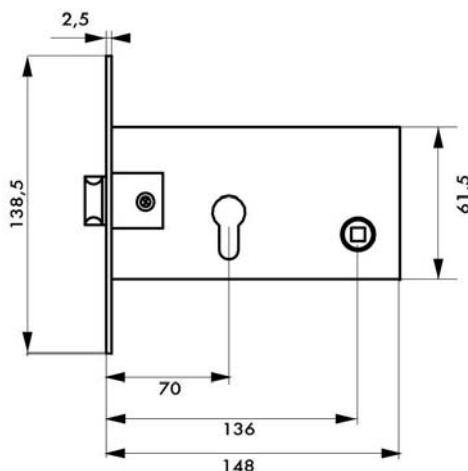

Description/Description/Descripción

Coffre acier embouti épaisseur 12 mm. Tête acier bouts carrés. Demi-tour réversible sans démontage du coffre. Pêne alliage zingué . Gâche plate acier. Carré 8 mm, entr'axe 66 mm.

Stamped steel case thickness 12 mm. Steel forend. Reversible latch without removing the case. Zinc plated alloy bolt. Steel flat striker. Square 8 mm.

Caja de acero embutido espesor 12 mm. Cabeza de acero. Media vuelta reversible sin desmontar la caja. Pestillo de aleación cincada . Cerradero plano de acero. Cuadrado 8 mm.

Finition/Finish/Acabado

Epoxy noir.
Black epoxy.
Epoxi negro

Designation	Boite	Colis.	Prix	Sachet	Colis.	Prix	Brochable					Colis.	Prix
							France	Euro 1	Euro 2	Euro 3	Euro 4		
Boîtier serrure axe 70mm à cylindre tête nickelée	00094372	1	-	-	-	-	-	-	-	00594372	-	5	-

⚠ Non stocké/Non-stored/Producto no estocado - 📦 Sur stock Europe Zone 1 et Zone 2, nous consulter pour délai d'approvisionnement - 📦 Epuisement/Stock depletion/Agotamiento del stock

Axe à 80 mm / A CYLINDRE PROTECT



GARANTIE

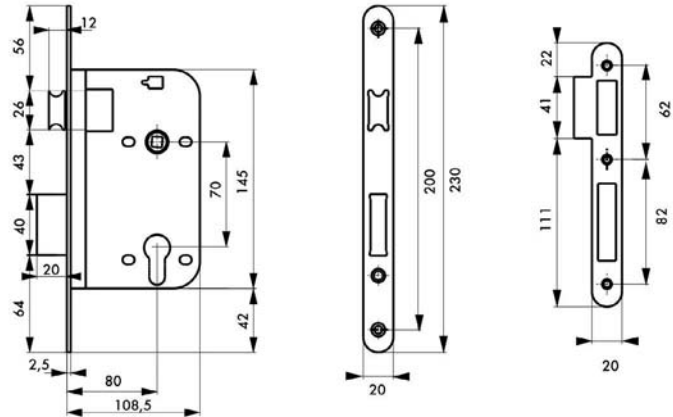

Description/Description/Descripción

Coffre acier embouti. Têtière laiton. 1/2 tour laiton réversible sans démontage du coffre. Pêne laiton. Rappel du 1/2 tour par la clé. Carré 7 mm, entr'axe 70 mm. Gâche plate selon finition.

Stamped steel case. Brass forend. Reversible brass latch without removing the case. Brass bolt. Draw back of the latch by key. Square 7 mm. Flat striker.

Caja de acero embutido. Cabeza de latón. Media vuelta de latón reversible. sin desmontar la caja. Pestillo de latón. Reposición de la media vuelta con la llave. Cuadrado 7 mm. Cerradero plano.

Finition/Finish/Acabado

Epoxy noir. Têtière laiton brossé. Têtière laiton poli verni. Têtière nickelé. Têtière noire.

Black epoxy. Brushsed brass forend - Black forend Polished brass forend - Nickel forend Epoxi negro Cabeza de latón cepillado. Cabeza de latón pulido barnizado Cabeza niquelado - Cabeza negro

Version/Option/Versión

Bec de cane. A condamnation
Without key. With locking for bathroom
Resbalón - De condenación

Designation	Boîte	Colis.	Prix	Sachet	Colis.	Prix	Brochable					Colis.	Prix
							France	Euro 1	Euro 2	Euro 3	Euro 4		
Boîtier serrure axe 80mm à cylindre tête laiton poli verni V/BR/L	00080296	5	-	-	-	-	-	-	-	-	-	-	-
Boîtier serrure axe 80mm à cylindre tête nickelé V/BR/L	00081296	5	-	-	-	-	-	-	-	-	-	-	-
Boîtier serrure axe 80mm à cylindre tête noire V/BR/L	00081256	5	-	-	-	-	-	-	-	-	-	-	-

Non stocké/Non-stored/Producto no estocado - Sur stock Europe Zone 1 et Zone 2, nous consulter pour délai d'approvisionnement - Epuisement/Stock depletion/Agotamiento del stock

Axe 15 mm / A CYLINDRE PROTECT

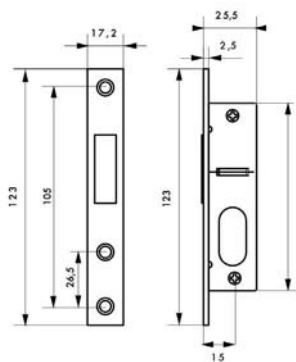

GARANTIE



X 3

Description/Description/Descripción

Coffre acier. Tête inox. Réversible. Pêne alliage nickelé. Gâche inox.

Steel case. Stainless steel forend. Reversible Nickel plated alloy dead bolt. Stainless steel striker.

Cabeza de acero. Cabeza de acero inoxidable. Reversible. Pestillo de aleación niquelada. Cerradero de acero inoxidable.

Finition/Finish/Acabado

Tête inox

Stainless steel forend

Cabeza de acero inoxidable

Utilisation/Use/Utilización

Porte menuiserie métallique
Metal joinerie

Puertas de carpintería metálica

Designation	Boite	Colis.	Prix	Sachet	Colis.	Prix	Brochable					Colis.	Prix
							France	Euro 1	Euro 2	Euro 3	Euro 4		
Serrure axe 15mm à cylindre ovale tête inox 3 clés	00094398	1	-	-	-	-	-	-	-	00494398	-	5	-

Axe 17, 27, 37 mm / A CYLINDRE PROTECT



	013920	013921	0103922
A	17 mm	27 mm	37 mm
B	32 mm	42 mm	52 mm

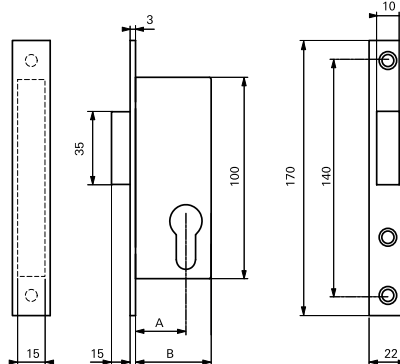

GARANTIE

Description/Description/Descripción

Coffre acier zingué plastifié. Tête inox. Réversible. Pêne alliage nickelé.

Zinc and plastic plated steel case. Stainless steel forend. Reversible Nickel plated alloy dead bolt.

Caja de acero galvanizado recubierto de plástico. Cabeza de acero inoxidable. Reversible. Pestillo de aleación niquelada.

Finition/Finish/Acabado

Tête inox

Stainless steel forend

Cabeza de acero inoxidable

Utilisation/Use/Utilización

Porte menuiserie métallique
Metal joinerie

Puertas de carpintería metálica

Designation	Boite	Colis.	Prix	Sachet	Colis.	Prix	Brochable					Colis.	Prix
							France	Euro 1	Euro 2	Euro 3	Euro 4		
Boîtier serrure axe 17mm à cylindre - pêne dormant seul	00013920	5	-	-	-	-	-	-	-	-	-	-	-
Boîtier serrure axe 27mm à cylindre - pêne dormant seul	00013921	5	-	-	-	-	-	-	-	-	-	-	-
Boîtier serrure axe 37mm à cylindre - pêne dormant seul	00013922	5	-	-	-	-	-	-	-	-	-	-	-

⚠ Non stocké/Non-stored/Producto no estocado - 📦 Sur stock Europe Zone 1 et Zone 2, nous consulter pour délai d'approvisionnement - 📦 Epuisement/Stock depletion/Agotamiento del stock

Entraxe 70 mm / A CYLINDRE

PROTECT



GARANTIE



X 3

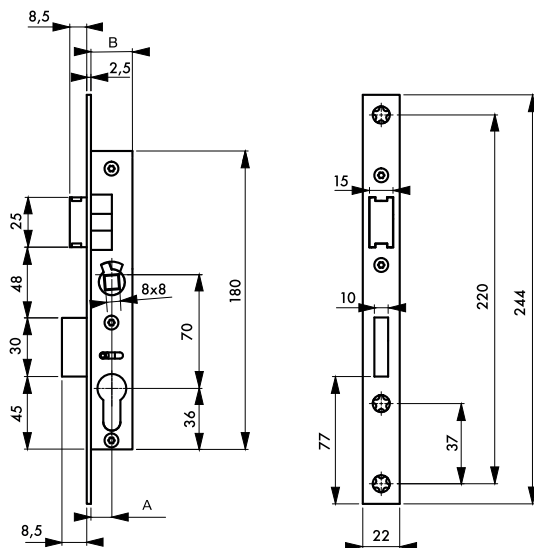

	000721	000728
A	10,5	16,5
B	21	28

Description/Description/Descripción

Coffre acier. Têtière inox. Demi-tour réversible sans démontage du coffre. Pêne alliage nickelé. Gâche plate inox. Carré 8 mm avec fourreau réducteur 7 mm. Entraxe 70 mm

Steel case. Stainless steel forend. Reversible latch without removing the case. Nickel plated alloy dead bolt. Stainless steel flat striker. Square 8 mm with spindle sleeve 7 mm. Nylon spindle sleeve 7 mm.

Caja de acero. Cabeza de acero inoxidable. Media vuelta reversible sin desmontar la caja. Pestillo de aleación niquelada. Cerradero plano de acero. Cuadrado 8 mm con funda reductora de 7 mm. Funda de nailon de 7 mm.

Finition/Finish/Acabado

Zingué

Zinc plated

Cincado

Version/Option/Versión

Avec cylindre profilé laiton nickelé 30 x 30 mm, 3 clés panneton réduit.

With nickel plated brass profile cylinder 30 x 30 mm, 3 keys with reduced driver cam.

Con cilindro perfilado de latón niquelado. 30 x 30 mm, 3 llaves pivote reducido.

Utilisation/Use/Utilización

Porte menuiserie métallique

Metal joinerie

Puertas de carpintería metálica

Designation	Boite	Colis.	Prix	Sachet	Colis.	Prix	Brochable					Colis.	Prix
							France	Euro 1	Euro 2	Euro 3	Euro 4		
Serrure axe 10,5mm à cylindre profilé L 21 Entraxe 70mm 3 clés	00000721	5	-	00900721	10	-	00400721	-	-	-	-	5	-
Serrure axe 16,5mm à cylindre profilé L 28 Entraxe 70mm 3 clés	00000728	5	-	00900728	10	-	00400728	-	-	-	-	5	-
Boîtier serrure axe 10,5mm à cylindre panneton réduit L 21 mm Entraxe 70mm	00011721	5	-	-	-	-	00411721	-	-	-	-	5	-
Boîtier serrure axe 16,5mm à cylindre panneton réduit L 28 mm Entraxe 70mm	00011728	5	-	-	-	-	00411728	-	-	-	-	5	-

Non stocké/Non-stored/Producto no estocado - Sur stock Europe Zone 1 et Zone 2, nous consulter pour délai d'approvisionnement - Epuement/Stock depletion/Agotamiento del stock

Entraxe 70 mm / A CYLINDRE

PROTECT



GARANTIE

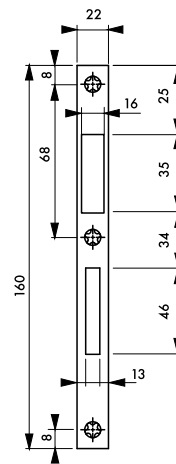
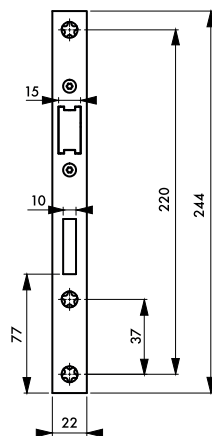
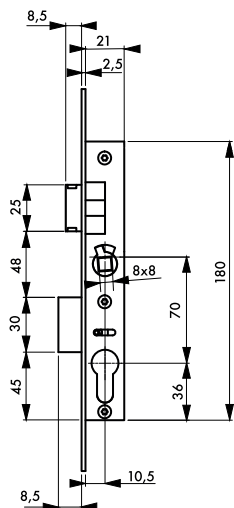

014100

	014710	014716
A	10,5	16,5
B	21	28

Description/Description/Descripción

Coffre acier épaisseur 15 mm. Têtière inox. Demi-tour réversible sans démontage du coffre. Pêne acier nickelé. Carré 8 mm. Livrée sans gâche.

Steel case thickness 15 mm. Stainless steel forend. Reversible latch without removing the case. Nickel plated steel dead bolt. Square 8 mm. Delivered without striker.

Caja de acero de un espesor 15 mm. Cabeza de acero inoxidable. Media vuelta reversible sin desmontar la caja. Pestillo de acero niquelada. Cuadrado 8 mm. Entregada sin cerradero.

Finition/Finish/Acabado

Zingué

Zinc plated

Cincado

Utilisation/Use/Utilización

Porte menuiserie métallique

Metal joinerie

Puertas de carpintería metálica

Designation	Boite	Colis.	Prix	Sachet	Colis.	Prix	Brochable					Colis.	Prix
							France	Euro 1	Euro 2	Euro 3	Euro 4		
Boitier de serrure axe 10,5mm à cylindre L 21 Entraxe 70mm	00014710	1	-	00914710	10	-	-	-	-	-	-	-	-
Boitier de serrure axe 16,5mm à cylindre L 28 Entraxe 70mm	00014716	1	-	00914716	10	53.03	-	-	-	-	-	-	-
Gâche plate inox coffre réduit 160 x 22 x 1,5mm	00014100	1	-	-	-	-	-	-	-	-	-	-	-

Ⓜ Non stocké/Non-stored/Producto no estocado - Ⓜ Sur stock Europe Zone 1 et Zone 2, nous consulter pour délai d'approvisionnement - Ⓜ Epuisement/Stock depletion/Agotamiento del stock

Entraxe 70 mm / A CYLINDRE

PROTECT



GARANTIE



X 3

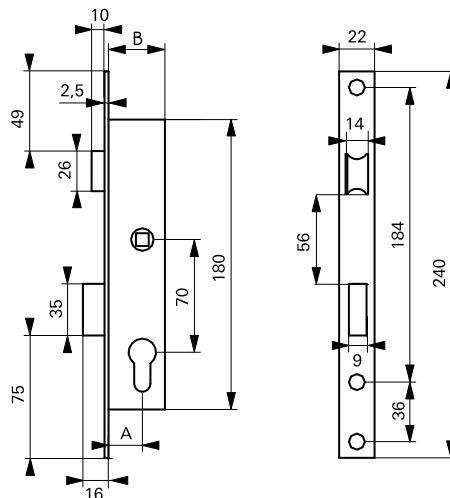

	000735	011739	000745
A	22	24	32
B	40	39	50

Description/Description/Descripción

Coffre acier. Tête inox. Demi-tour réversible sans démontage du coffre. Rappel du 1/2 tour par la clé. Pêne alliage nickelé. Gâche plate inox. Carré 8 mm avec fourreau réducteur 7 mm. Entr'axe 70 mm.

Steel case. Stainless steel forend. Reversible latch without removing the case. Draw back of the latch by key. Nickel plated alloy dead bolt. Stainless steel flat striker. Square 8 mm with spindle sleeve 7 mm. Nylon spindle sleeve 7 mm.

Caja de acero. Cabeza de acero inoxidable. Media vuelta reversible sin desmontar la caja. Reposición de la media vuelta con la llave. Pestillo de aleación níquelada. Cerradero plano de acero. Cuadrado 8 mm con funda reductora de 7 mm. Funda de nailon de 7 mm.

Finition/Finish/Acabado

Zingué
Zinc plated
Cincado

Versión/Option/Versión

Avec cylindre profilé laiton nickelé 30 x 30 mm, 3 clés
With nickel plated brass profile cylinder 30 x 30 mm, 3 keys

Con cilindro perfilado de latón níquelado. 30 x 30 mm, 3 llaves

Utilisation/Use/Utilización

Porte menuiserie métallique
Metal joinerie
Puertas de carpintería metálica

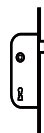

Designation	Boite	Colis.	Prix	Sachet	Colis.	Prix	Brochable					Colis.	Prix
							France	Euro 1	Euro 2	Euro 3	Euro 4		
Serrure axe 22mm à cylindre profilé L 40 Entraxe 70mm 3 clés	-	-	-	00900735	10	-	00400735	-	-	-	-	5	-
Serrure axe 32mm à cylindre profilé L 40 Entraxe 70mm 3 clés	-	-	-	00900745	10	-	00400745	-	-	-	-	5	-
Boîtier serrure axe 22mm à cylindre L 40 mm Entraxe 70mm	00011735	5	-	00911735	10	-	00411735	-	-	-	-	5	-
Boîtier serrure axe 24mm à cylindre L 39 mm Entraxe 70mm	00011739	5	-	00911739	10	-	-	-	-	-	-	-	-
Boîtier serrure axe 32mm à cylindre L 50 mm Entraxe 70mm	00011745	5	-	00911745	10	-	00411745	-	-	-	-	5	-

Non stocké/Non-stored/Producto no estocado - Sur stock Europe Zone 1 et Zone 2, nous consulter pour délai d'approvisionnement - Epuisement/Stock depletion/Agotamiento del stock

ENTRAXE 70 MM / A CYLINDRE

PROTECT



GARANTIE

RÉVERSIBLE SANS OUTILS.

Conforme à la norme NF EN 12209

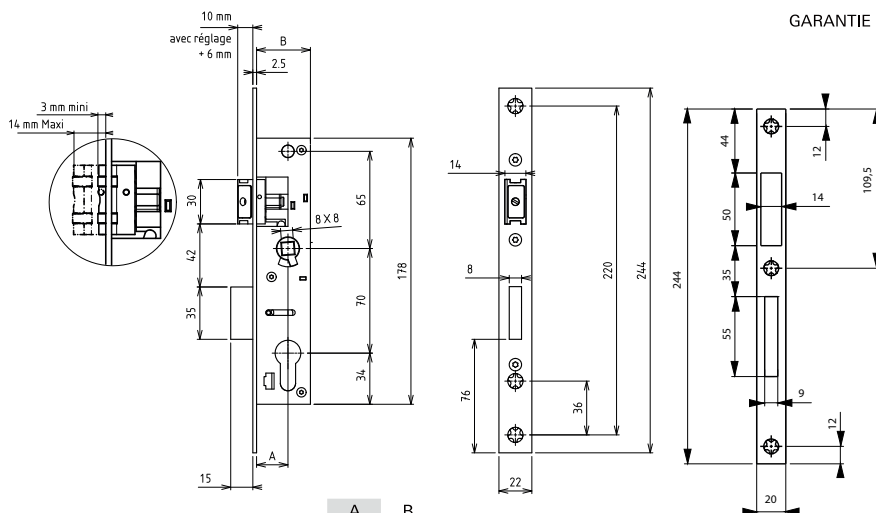

	A	B
014721	21	36
014724	24	39
014730	30	45

Description/Description/Descripción

Coffre acier épaisseur 15 mm. Tête inox. Demi-tour réversible sans démontage. Rappel du 1/2 tour par la clé. Pêne acier nickelé. Carré 8 mm. Livrée avec rouleau interchangeable. Livrée sans gâche. Accessoires : gâche inox épaisseur 2,5 mm compatible version pêne dormant 1/2 tour et rouleau.

Steel case thickness 15 mm. Stainless steel forend. Reversible latch without removing. Draw back of the latch by key. Nickel plated steel dead bolt. Square 8 mm. Delivered with interchangeable roll. Delivered without striker. Accessories : Stainless version Deadbolt and roller.

Cabeza de acero espesor 15 mm. Cabeza de acero inoxidable. Media vuelta reversible sin desmontar. Reposición de la media vuelta con la llave. Pestillo de acero niquelado. Cuadrado 8 mm. Entregada con rodillo intercambiable. Entregada sin cerradero. Accesorios : Cerradero de acero inoxidable, versión compatible pestillo y rodillo.

Finition/Finish/Acabado

Zingué

Zinc coated

Cincado

Utilisation/Use/Utilización

Porte menuiserie métallique

Metal joinerie

Puertas de carpintería metálica

Accessoires/Accessories/Acesorios

Gâche inox épaisseur 2,5 mm, compatible version pêne dormant 1/2T et rouleau.

Stainless steel striker thickness 2,5 mm, compatible with deadbolt and roller version

Cerradero de acero inoxidable 2,5 mm, versión compatible pestillo et rodillo

Designation	Boite	Colis.	Prix	Sachet	Colis.	Prix	Brochable					Colis.	Prix
							France	Euro 1	Euro 2	Euro 3	Euro 4		
Boîtier serrure axe 21mm à cylindre L 36 mm Entraxe 70mm	00014721	5	-	-	-	-	-	-	-	-	-	-	-
Boîtier serrure axe 24mm à cylindre L 39 mm Entraxe 70mm	00014724	5	-	-	-	-	-	-	-	-	-	-	-
Boîtier serrure axe 30mm à cylindre L 45 mm Entraxe 70mm	00014730	5	-	-	-	-	-	-	-	-	-	-	-
Gâche plate inox double empénage 244x20x2,5 mm	00014000	5	-	-	-	-	-	-	-	-	-	-	-

⚠ Non stocké/Non-stored/Producto no estocado - 📦 Sur stock Europe Zone 1 et Zone 2, nous consulter pour délai d'approvisionnement - 📦 Epuisement/Stock depletion/Agotamiento del stock

Entraxe 70 mm / A CYLINDRE

PROTECT Réversible sans outils.
Rouleau interchangeable (en option)



GARANTIE

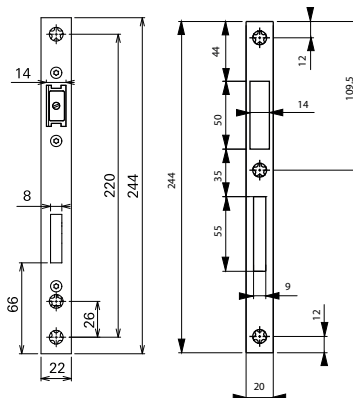
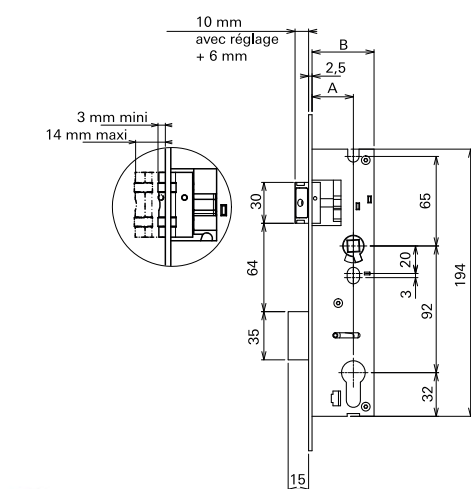

	A	B	Entr'axe
015721	21	36	70
015724	24	39	70
015730	30	45	70

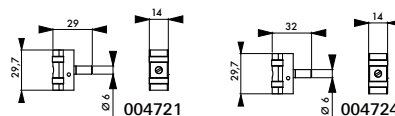

Description/Description/Descripción

Coffre acier épaisseur 15 mm. Tête inox. Demi-tour réversible sans démontage. Rappel du 1/2 tour par la clé. Pêne acier nickelé. Carré 8 mm. Livrée sans rouleau interchangeable. Livrée sans gâche.

Steel case thickness 15 mm. Stainless steel forend. Reversible latch without removing. Draw back of the latch by key. Nickel plated steel dead bolt. Square Delivered with interchangeable roll. Delivered without striker.

Cabeza de acero espesor 15 mm. Cabeza de acero inoxidable. Media vuelta reversible sin desmontar. Reposición de la media vuelta con la llave. Pestillo de acero niquelado. Cuadrado Entregada con rodillo intercambiable.

Entregada sin cerradero.

Finition/Finish/Acabado

Zingué / Zinc plated / Cincado

Version/Option/Versión

Serrure bec de cane pour gâche électrique.

Door lock for electric striker.

Cerradura de la semilla de cerradura eléctrica.

Utilisation/Use/Utilización

Porte menuiserie métallique

Metal joinerie

Puertas de carpintería metálica

Accessoires/Accessories/Accesorios

Gâche inox épaisseur 2,5 mm, compatible version pêne dormant 1/2T et rouleau.

Stainless steel striker thickness 2,5mm, compatible with deadbolt and roller version

Cerradero de acero inoxidable 2,5mm, versión compatible pestillo et rodillo

Designation	Boite	Colis.	Prix	Sachet	Colis.	Prix	Brochable					Colis.	Prix
							France	Euro 1	Euro 2	Euro 3	Euro 4		
Boîtier serrure axe 21mm à cylindre L 36 mm Entraxe 70mm	00015721	1	-	00915721	10	-	-	-	-	-	-	-	-
Boîtier serrure axe 24mm à cylindre L 39 mm Entraxe 70mm	00015724	1	-	00915724	10	-	-	-	-	-	-	-	-
Boîtier serrure axe 30mm à cylindre L 45 mm Entraxe 70mm	00015730	1	-	00915730	10	-	-	-	-	-	-	-	-
Rouleau interchangeable pour serrure axe 21mm	00004721	10	-	00904721	10	-	-	-	-	-	-	-	-
Rouleau interchangeable pour serrure axe 24mm	00004724	10	-	00904724	10	-	-	-	-	-	-	-	-
Rouleau interchangeable pour serrure axe 30mm	00004930	10	-	00904930	10	-	-	-	-	-	-	-	-
Gâche plate inox double empénage 244x20x2,5 mm	00014000	25	-	00914000	10	-	-	-	-	-	-	-	-

☒ Non stocké/Non-stored/Producto no estocado - ☑ Sur stock Europe Zone 1 et Zone 2, nous consulter pour délai d'approvisionnement - ☒ Epuisement/Stock depletion/Agotamiento del stock

Entraxe 85 mm / A CYLINDRE

PROTECT



GARANTIE

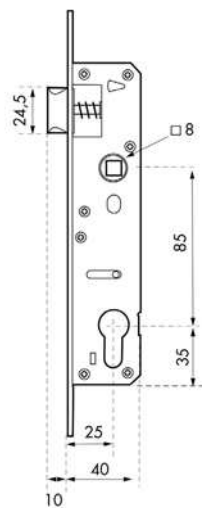

092133

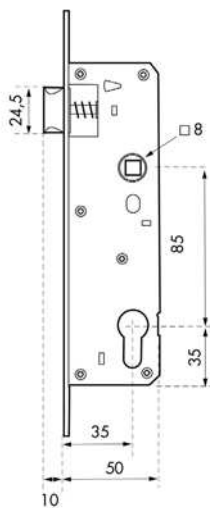

092134

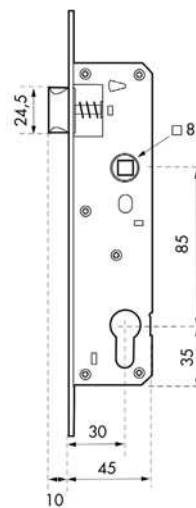

092135

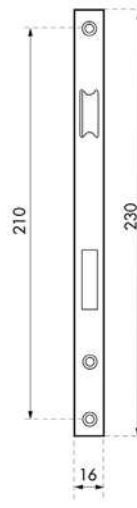

Description/Description/Descripción

Coffre acier. Têtière inox épaisseur 16 mm. Demi-tour réversible sans démontage du coffre. Rappel du 1/2 tour par la clé. Pêne acier nickelé. Carré 8 mm. Livrée sans gâche.

Steel case thickness. Stainless steel forend 16 mm. Reversible latch without removing the case. Draw back of the latch by key. Nickel plated steel dead bolt. Square 8 mm. Delivered without striker.

Caja de acero. Cabeza de acero inoxidable de un espesor 16 mm. Media vuelta reversible sin desmontar la caja. Reposición de la media vuelta con la llave. Pestillo de acero niquelada. Cuadrado 8 mm. Entregada sin cerradero.

Finition/Finish/Acabado

Zingué. Têtière inox.

Zinc Plated. Stainless steel forend.

Cincado. Cabeza de acero inoxidable.

Utilisation/Use/Utilización

Porte menuiserie métallique

Metal joinerie

Puertas de carpintería metálica

Designation	Boite	Colis.	Prix	Sachet	Colis.	Prix	Brochable					Colis.	Prix
							France	Euro 1	Euro 2	Euro 3	Euro 4		
Boîtier serrure axe 25mm à cylindre Entraxe 85mm T16	00092133 NS	1	-	-	-	-	-	-	00492133 NS	-	-	5	-
Boîtier serrure axe 30mm à cylindre Entraxe 85mm T16	00092134 NS	1	-	-	-	-	-	-	00492134 NS	-	-	5	-
Boîtier serrure axe 35mm à cylindre Entraxe 85mm T16	00092135 NS	1	-	-	-	-	-	-	00492135 NS	-	-	5	-

NS Non stocké/Non-stored/Producto no estocado - S Sur stock Europe Zone 1 et Zone 2, nous consulter pour délai d'approvisionnement - E Epuisement/Stock depletion/Agotamiento del stock

Entraxe 85 mm / A CYLINDRE

PROTECT



GARANTIE

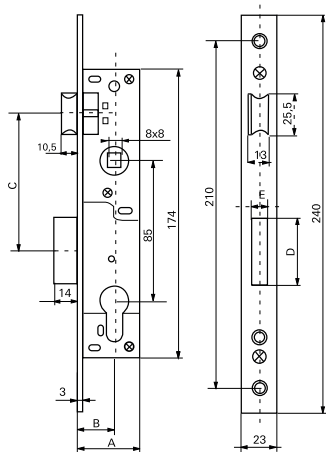

	A	B	C	D	E
20 mm	33	21	87	35	9
25 mm	40	25	83	40	10
30 mm	46	30	86	35	8

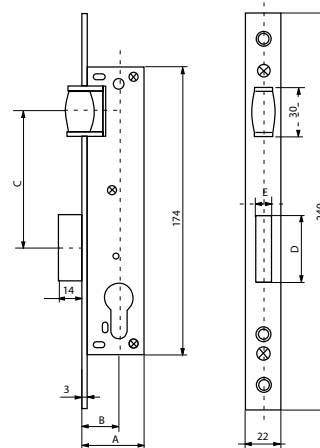

	A	B	C	D	E
20 mm	33	21	87	35	9
25 mm	40	25	83	40	10
30 mm	45	30	81	40	10

Description/Description/Descripción

Coffre acier. Têtière inox. Demi-tour réversible sans démontage du coffre. Rappel du 1/2 tour par la clé. Pêne alliage nickelé. Gâche inox. Carré 8 mm, entraxe 85 mm.
 Steel case. Stainless steel forend. Reversible latch without removing the case. Draw back of the latch by key. Nickel plated alloy dead bolt. Stainless steel striker. Square 8 mm.

Cabeza de acero. Cabeza de acero inoxidable. Media vuelta reversible sin desmontar la caja. Reposición de la media vuelta con la llave. Pestillo de aleación niquelada. Cerradero de acero inoxidable. Cuadrado 8 mm.

Finition/Finish/Acabado

Zingué
 Zinc plated
 Cincado

Version/Option/Versión

A rouleau
 Roller
 Rodillo

Utilisation/Use/Utilización

Porte menuiserie métallique
 Metal joinerie
 Puertas de carpintería metálica



Designation	Boite	Colis.	Prix	Sachet	Colis.	Prix	Brochable					Colis.	Prix
							France	Euro 1	Euro 2	Euro 3	Euro 4		
Boîtier serrure axe 20mm à cylindre L 36 Entraxe 85mm	00011820	5	-	-	-	-	00411820	00493271 NS	00492271 NS	00494271	-	5	-
Boîtier serrure axe 25mm à cylindre L 41 Entraxe 85mm	00011825	5	-	-	-	-	00411825	00493272 NS	00492272 NS	00494272	-	5	-
Boîtier serrure axe 30mm à cylindre L 46 Entraxe 85mm	00011830	5	-	-	-	-	00411830	00493273 NS	00492273 NS	00494273	-	5	-
Boîtier serrure axe 20mm à cyl. à rouleau L 36	00011821	5	-	-	-	-	00411821	00493274 NS	00492274 NS	00494274	-	5	-
Boîtier serrure axe 25mm à cyl. à rouleau L 41	00011826	5	-	-	-	-	00411826	00493275 NS	00492275 NS	00494275	-	5	-
Boîtier serrure axe 30mm à cyl. à rouleau L 46	00011831	5	-	-	-	-	00411831	00493276 NS	00492276 NS	00494276	-	5	-

NS Non stocké/Non-stored/Producto no estocado - Sur stock Europe Zone 1 et Zone 2, nous consulter pour délai d'approvisionnement - E Epuïsement/Stock depletion/Agotamiento del stock

Entraxe 85 mm / A CYLINDRE PROTECT



GARANTIE



X 3

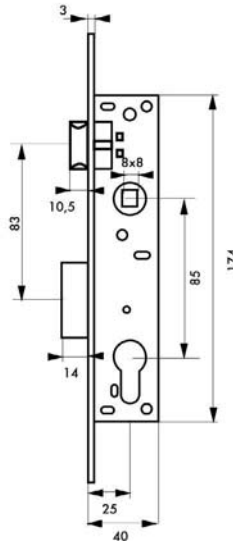

Description/Description/Descripción

Coffre acier. Têtière inox. Demi-tour réversible sans démontage. du coffre. Rappel du 1/2 tour par la clé. Pêne alliage nickelé. Gâche inox. Carré 8 mm, entr'axe 85 mm. *Steel case. Stainless steel forend. Reversible latch without removing the case. Draw back of the latch by key. Nickel plated alloy dead bolt. Stainless steel striker. Square 8 mm.*

Cabeza de acero. Cabeza de acero inoxidable. Media vuelta reversible sin desmontar la caja. Reposición de la media vuelta con la llave. Pestillo de aleación niquelada. Cerradero de acero inoxidable. Cuadrado 8 mm.

Finition/Finish/Acabado

Zingué
Zinc coated
Cincado

Utilisation/Use/Utilización

Porte menuiserie métallique
Metal joinerie
Puertas de carpintería metálica

Designation	Boite	Colis.	Prix	Sachet	Colis.	Prix	Brochable					Colis.	Prix
							France	Euro 1	Euro 2	Euro 3	Euro 4		
Serrure axe 25mm à cylindre profilé 3 clés	N0094600 E NS	1	-	-	-	-	-	-	-	00494600	-	5	-
Serrure axe 30mm à cylindre profilé 3 clés	-	-	-	-	-	-	-	-	-	00494601	-	5	-

NS Non stocké/Non-stored/Producto no estocado - Sur stock Europe Zone 1 et Zone 2, nous consulter pour délai d'approvisionnement - E Epusement/Stock depletion/Agotamiento del stock

Entraxe 85 mm / A CYLINDRE PROTECT



GARANTIE



X 3

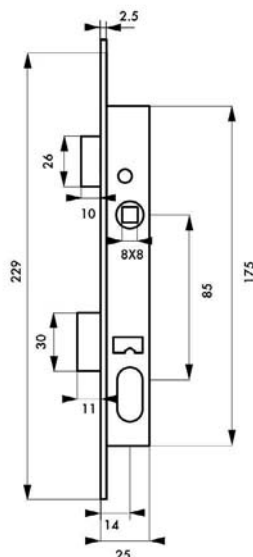

Description/Description/Descripción

Coffre acier. Têtière acier laitonée . Demi-tour réversible.
Pêne laiton. Gâche acier laitonée. Carré 8 mm, entraxe
85 mm.

*Steel case. Brass plated steel forend. Reversible latch.
Brass dead bolt. Brass plated steel striker. Square 8 mm
Cabeza de acero. Cabeza de acero latonado. Media
vuelta reversible. Pestillo de latón. Cerradero de acero
latonado. Cuadrado 8mm*

Finition/Finish/Acabado

Zingué
Zinc coated
Cincado

Utilisation/Use/Utilización

Porte menuiserie métallique
Metal joinerie
Puertas de carpintería metálica

Designation	Boite	Colis.	Prix	Sachet	Colis.	Prix	Brochable					Colis.	Prix
							France	Euro 1	Euro 2	Euro 3	Euro 4		
Serrure axe 14mm à cylindre profilé 3 clés	00094381	1	-	-	-	-	-	-	-	00494381	-	5	-

⊗ Non stocké/Non-stored/Producto no estocado - ⊠ Sur stock Europe Zone 1 et Zone 2, nous consulter pour délai d'approvisionnement - ⊞ Epuisement/Stock depletion/Agotamiento del stock

Entraxe 92 mm / À CYLINDRE PROTECT



GARANTIE

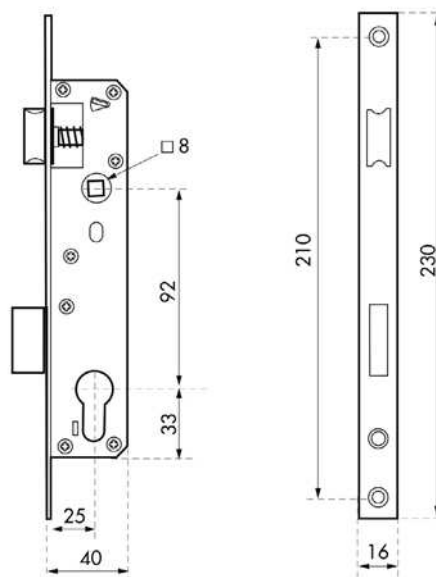

Description/Description/Descripción

Coffre acier. Têtière inox épaisseur 16mm. Demi-tour réversible sans démontage du coffre. Rappel du 1/2 tour par la clé. Pêne acier nickelé. Carré 8 mm. Livrée sans gâche.

Steel case thickness. Stainless steel forend 16 mm. Reversible latch without removing the case. Draw back of the latch by key. Nickel plated steel dead bolt. Square 8 mm. Delivered without striker.

Caja de acero. Cabeza de acero inoxidable de un espesor 16 mm. Media vuelta reversible sin desmontar la caja. Reposición de la media vuelta con la llave. Pestillo de acero niquelada. Cuadrado 8 mm. Entregada sin cerrero.

Finition/Finish/Acabado

Zingué. Têtière inox.

Zinc Plated. Stainless steel forend.

Cincado. Cabeza de acero inoxidable.

Utilisation/Use/Utilización

Porte menuiserie métallique

Metal joinerie

Puertas de carpintería metálica

Designation	Boite	Colis.	Prix	Sachet	Colis.	Prix	Brochable					Colis.	Prix
							France	Euro 1	Euro 2	Euro 3	Euro 4		
Boîtier serrure axe 25mm à cylindre entraxe 92mm T16	-	-	-	00992136	10	-	-	-	-	-	-	-	-
Boîtier serrure axe 35mm à cylindre entraxe 92mm T16	-	-	-	00992137	10	-	-	-	-	-	-	-	-

Ⓜ Non stocké/Non-stored/Producto no estocado - ☑ Sur stock Europe Zone 1 et Zone 2, nous consulter pour délai d'approvisionnement - ☒ Epuisement/Stock depletion/Agotamiento del stock

Entraxe 92 mm / A CYLINDRE

PROTECT



GARANTIE



X 3

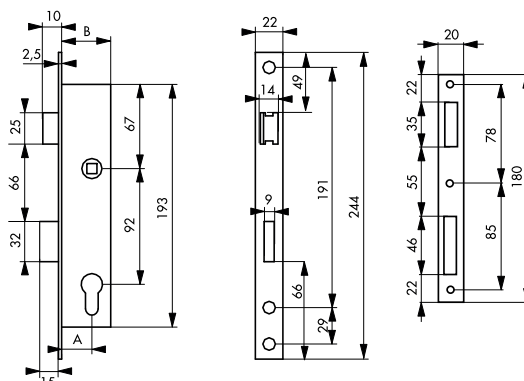

A	21	24	26	30
B	36	39	41	45

Description/Description/Descripción

Coffre acier. Têtière inox. Demi-tour réversible sans démontage. du coffre. Rappel du 1/2 tour par la clé. Pêne alliage nickelé. Gâche inox. Carré 8 mm, entr'axe 92 mm.
 Steel case. Stainless steel forend. Reversible latch without removing the case. Draw back of the latch by key. Nickel plated alloy dead bolt. Stainless steel striker. Square 8 mm.

Cabeza de acero. Cabeza de acero inoxidable. Media vuelta reversible sin desmontar la caja. Reposición de la media vuelta con la llave. Pestillo de aleación niquelada. Cerradero de acero inoxidable. Cuadrado 8 mm.

Finition/Finish/Acabado

Zingué
 Zinc plated
 Cincado

Version/Option/Versión

Avec cylindre profilé laiton nickelé 30 x 30 mm. 3 clés.
 With nickel plated brass profile cylinder 30 x 30 mm. 3 keys.

Con cilindro perfilado de latón niquelado 30 x 30 mm. 3 llaves.

Utilisation/Use/Utilización

Porte menuiserie métallique
 Metal joinerie
 Puertas de carpintería metálica

Designation	Boite	Colis.	Prix	Sachet	Colis.	Prix	Brochable					Colis.	Prix
							France	Euro 1	Euro 2	Euro 3	Euro 4		
Serrure axe à 21mm à cylindre profilé L 36 T22 3 clés	-	-	-	00926036	10	-	00426036	-	-	-	-	5	-
Serrure axe à 24mm à cylindre profilé L 39 T22 3 clés	-	-	-	00926039	10	-	00426039	-	-	-	-	5	-
Serrure axe à 26mm à cylindre profilé L 41 T22 3 clés	00026041	5	-	-	-	-	-	-	-	-	-	-	-
Serrure axe à 30mm à cylindre profilé L 45 T22 3 clés	00026045	5	-	-	-	-	-	-	-	-	-	-	-
Boîtier serrure axe 21mm à cylindre L 36 T22	00026136	5	-	00926136	10	-	00426136	-	-	-	-	5	-
Boîtier serrure axe 24mm à cylindre L 39 T22	00026139	5	-	-	-	-	00426139	00493262 NS	00492262 NS	00494262	-	5	-
Boîtier serrure axe 26mm à cylindre L 41 T22	00026141	5	-	-	-	-	-	-	-	-	-	-	-
Boîtier serrure axe 30mm à cylindre L 45 T22	00026145	5	-	00926145	10	-	-	00493313 NS	00492313 NS	-	-	5	-

NS Non stocké/Non-stored/Producto no estocado - Sur stock Europe Zone 1 et Zone 2, nous consulter pour délai d'approvisionnement - E Epuïsement/Stock depletion/Agotamiento del stock

Entraxe 92 mm / BEC DE CANE À CYLINDRE

PROTECT



GARANTIE



Réversible sans outils.
Conforme à la norme NF
EN 12209

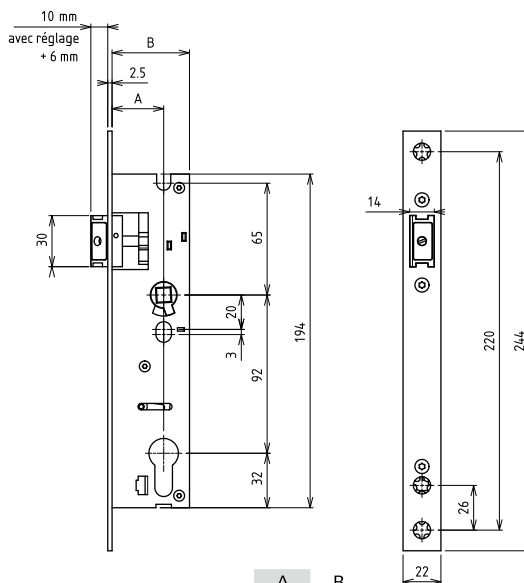

	A	B
024921	21	36
024924	24	39
024926	26	41
024930	30	45

Description/Description/Descripción

Coffre acier épaisseur 15 mm. Têtière inox. Demi-tour réversible sans démontage. Rappel du 1/2 tour par la clé. Pêne 1/2 tour acier nickelé. Carré 8 mm. Livrée sans gâche.

Steel case thickness 15 mm. Stainless steel forend. Reversible latch without removing. Draw back of the latch by key. Steel dead bolt. Square 8 mm.

Cabeza de acero espesor 15 mm. Cabeza de acero inoxidable. Media vuelta reversible sin desmontar. Reposición de la media vuelta con la llave. Pestillo de acero. Cuadrado 8 mm.

Finition/Finish/Acabado

Zingué

Zinc plated

Cincado

Version/Option/Versión

Serrure bec de cane pour gâche électrique.

Door lock for electric striker.

Cerradura de la semilla de cerradura eléctrica.

Utilisation/Use/Utilización

Porte menuiserie métallique

Metal joinerie

Puertas de carpintería metálica

Designation	Boite	Colis.	Prix	Sachet	Colis.	Prix	Brochable					Colis.	Prix
							France	Euro 1	Euro 2	Euro 3	Euro 4		
Boîtier serrure axe 21mm bec de cane L 36 T22	00024921	5	-	-	-	-	-	-	-	-	-	-	-
Boîtier serrure axe 24mm bec de cane L 39 T22	00024924	5	-	-	-	-	-	-	-	-	-	-	-
Boîtier serrure axe 26mm bec de cane L 41 T22	00024926	5	-	-	-	-	-	-	-	-	-	-	-
Boîtier serrure axe 30mm bec de cane L 45 T22	00024930	5	-	-	-	-	-	-	-	-	-	-	-

⚠ Non stocké/Non-stored/Producto no estocado - 📦 Sur stock Europe Zone 1 et Zone 2, nous consulter pour délai d'approvisionnement - 📦 Epuisement/Stock depletion/Agotamiento del stock

Entraxe 92 mm / À CYLINDRE

PROTECT



GARANTIE

Réversible sans outils.
Avec rouleau interchangeable
Conforme à la norme NF
EN 12209

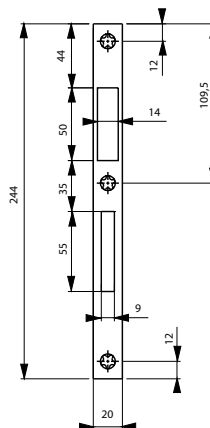
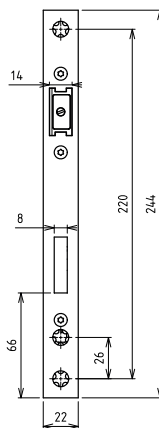
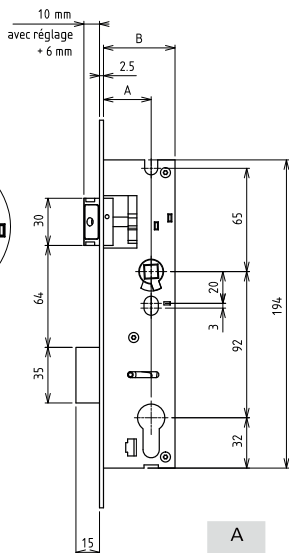
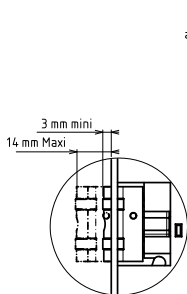

	A	B
014921	21	36
014924	24	39
014926	26	41
014930	30	45

Description/Description/Descripción

Coffre acier épaisseur 15 mm. Têtière inox. Demi-tour réversible sans démontage. Rappel du 1/2 tour par la clé. Pêne acier nickelé. Carré 8 mm. Livrée avec rouleau interchangeable. Livrée sans gâche.

Steel case thickness 15 mm. Stainless steel forend. Reversible latch without removing. Draw back of the latch by key. Nickel plated steel dead bolt. Square 8mm. Delivered with interchangeable roll. Delivered without striker.

Cabeza de acero espesor 15 mm. Cabeza de acero inoxidable. Media vuelta reversible sin desmontar. Reposición de la media vuelta con la llave. Pestillo de acero niquelado. Cuadrado 8 mm. Entregada con rodillo intercambiable. Entregada sin cerradero.

Finition/Finish/Acabado

Zingué
Zinc plated
Cincado

Version/Option/Versión

Serrure bec de cane pour gâche électrique.
Door lock for electric striker.
Cerradura de la semilla de cerradura eléctrica.

Utilisation/Use/Utilización

Porte menuiserie métallique
Metal joinerie
Puertas de carpintería metálica

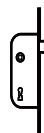

Designation	Boite	Colis.	Prix	Sachet	Colis.	Prix	Brochable					Colis.	Prix
							France	Euro 1	Euro 2	Euro 3	Euro 4		
Boîtier serrure axe 21mm à cylindre entraxe 92mm L 36 T22	00014921	5	-	-	-	-	-	-	-	-	-	-	-
Boîtier serrure axe 24mm à cylindre entraxe 92mm L 39 T22	00014924	5	-	-	-	-	-	-	-	-	-	-	-
Boîtier serrure axe 26mm à cylindre entraxe 92mm L 41 T22	00014926	5	-	-	-	-	-	-	-	-	-	-	-
Boîtier serrure axe 30mm à cylindre entraxe 92mm L 45 T22	00014930	5	-	-	-	-	-	-	-	-	-	-	-
Gache plate inox double empénage 244x20x2,5 mm	00014000	5	-	-	-	-	-	-	-	-	-	-	-

☐ Non stocké/Non-stored/Producto no estocado - ☑ Sur stock Europe Zone 1 et Zone 2, nous consulter pour délai d'approvisionnement - ☒ Epuisement/Stock depletion/Agotamiento del stock

Entraxe 92 mm / À CYLINDRE

PROTECT

Réversible
sans outils



Rouleau
interchangeable
(en option)

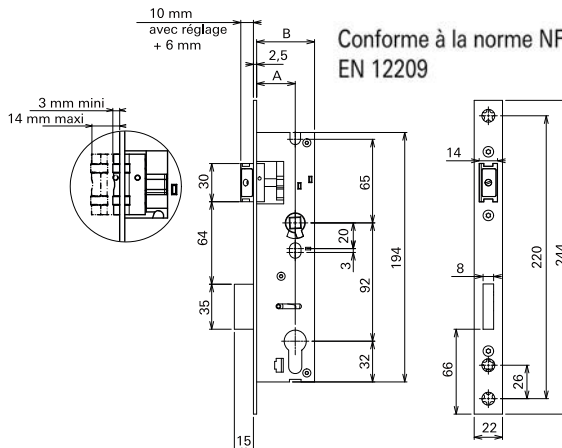

Conforme à la norme NF
EN 12209

	A	B	Entr'axe
015921	21	36	92
015924	24	39	92
015926	26	41	92
015930	30	45	92



GARANTIE

Description/Description/Descripción

Coffre acier épaisseur 15 mm. Têtière inox. Demi-tour réversible sans démontage. Rappel du 1/2 tour par la clé. Pêne acier nickelé. Carré 8 mm. Livrée sans rouleau interchangeable. Livrée sans gâche.

Steel case thickness 15 mm. Stainless steel forend. Reversible latch without removing. Draw back of the latch by key. Nickel plated steel dead bolt. Square 8mm. Delivered with interchangeable roll. Delivered without striker.

Cabeza de acero espesor 15 mm. Cabeza de acero inoxidable. Media vuelta reversible sin desmontar. Reposición de la media vuelta con la llave. Pestillo de acero niquelado. Cuadrado 8 mm. Entregada con rodillo intercambiable. Entregada sin cerradero.

Finition/Finish/Acabado

Zingué

Zinc plated

Cincado

Versión/Option/Versión

Serrure bec de cane pour gâche électrique.

Door lock for electric striker.

Cerradura de la semilla de cerradura eléctrica.

Utilisation/Use/Utilización

Porte menuiserie métallique

Metal joinerie

Puertas de carpintería metálica

Designation	Boite	Colis.	Prix	Sachet	Colis.	Prix	Brochable					Colis.	Prix
							France	Euro 1	Euro 2	Euro 3	Euro 4		
Boitier de serrure à cylindre axe 21mm L 36 entraxe 92 avec rouleau interchangeable	00015921	1	-	00915921	10	-	-	-	-	-	-	-	-
Boitier de serrure à cylindre axe 24mm L 39 entraxe 92 avec rouleau interchangeable	00015924	1	-	00915924	10	-	-	-	-	-	-	-	-
Boitier de serrure à cylindre axe 26mm L 41 entraxe 92 avec rouleau interchangeable	00015926	1	-	-	-	-	-	-	-	-	-	-	-
Boitier de serrure à cylindre axe 30mm L 45 entraxe 92 avec rouleau interchangeable	00015930	1	-	00915930	10	-	-	-	-	-	-	-	-
Rouleau interchangeable pour serrure axe 21mm	00004721	10	-	00904721	10	-	-	-	-	-	-	-	-
Rouleau interchangeable pour serrure axe 24mm	00004724	10	-	00904724	10	-	-	-	-	-	-	-	-
Rouleau interchangeable pour serrure axe 26mm	00004926	10	-	-	-	-	-	-	-	-	-	-	-
Rouleau interchangeable pour serrure axe 30mm	00004930	10	-	00904930	10	-	-	-	-	-	-	-	-
Gâche plate inox double empénage 244x20x2,5 mm	00014000	25	-	00914000	10	-	-	-	-	-	-	-	-

Non stocké/Non-stored/Producto no estocado - Sur stock Europe Zone 1 et Zone 2, nous consulter pour délai d'approvisionnement - Epuisement/Stock depletion/Agotamiento del stock

Entraxe 92 mm / À CYLINDRE

PROTECT



GARANTIE

Réversible sans outils.



Conforme à la norme NF EN 12209

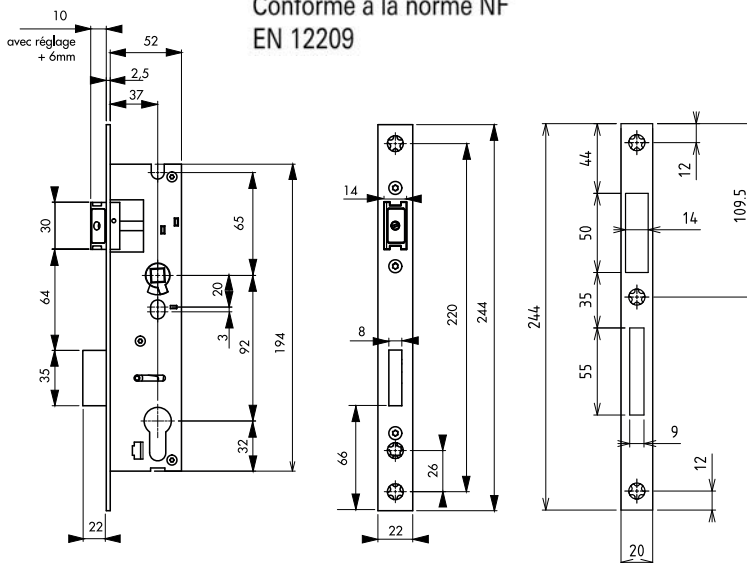

	A	B
014837	37	52
014842	42	57

014000

Description/Description/Descripción

Coffre acier épaisseur 15 mm. Têtière inox. Demi-tour réversible sans démontage du coffre. Rappel du 1/2 tour par la clé. Pêne acier nickelé. Carré 8 mm. Livrée sans gâche.

Steel case thickness 15 mm. Stainless steel forend. Reversible latch without removing the case. Draw back of the latch by key. Nickel plated steel dead bolt. Square 8 mm. Delivered without striker.

Caja de acero de un espesor 15 mm. Cabeza de acero inoxidable. Media vuelta reversible sin desmontar la caja. Reposición de la media vuelta con la llave. Pestillo de acero niquelada. Cuadrado 8 mm. Entregada sin cerradero.

Finition/Finish/Acabado

Zingué

Zinc plated

Cincado

Utilisation/Use/Utilización

Porte menuiserie métallique

Metal joinerie

Puertas de carpintería metálica

Designation	Boîte	Colis.	Prix	Sachet	Colis.	Prix	Brochable					Colis.	Prix
							France	Euro 1	Euro 2	Euro 3	Euro 4		
Boitier de serrure à cylindre axe 37mm L 52 entraxe 92	00014837	1	-	-	-	-	-	-	-	-	-	-	-
Boitier de serrure à cylindre axe 42mm L 57 entraxe 92	00014842	1	-	-	-	-	-	-	-	-	-	-	-
Gâche plate inox double empénage 244x20x2,5 mm	00014000	25	-	00914000	10	-	-	-	-	-	-	-	-

Non stocké/Non-stored/Producto no estocado - Sur stock Europe Zone 1 et Zone 2, nous consulter pour délai d'approvisionnement - Epuement/Stock depletion/Agotamiento del stock

Entraxe 70 mm / À CROCHET À CYLINDRE PROTECT

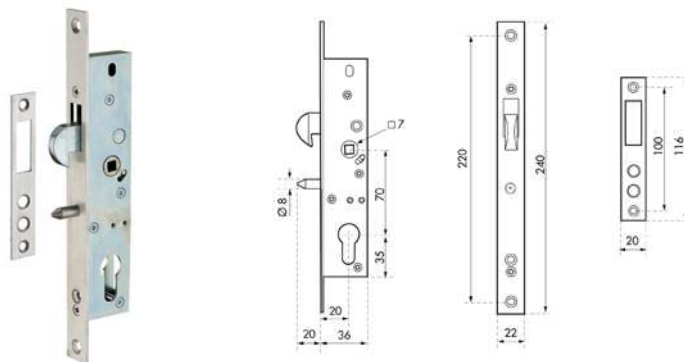

GARANTIE

Description/Description/Descripción

Coffre acier. Tête inox. Pêne crochet acier. Gâche plate inox. Carré de 7 mm.

Steel case. Stainless steel forend. Steel hook. Stainless steel striker. Square 7mm.

Caja de acero. Cabeza de acero inoxidable. Pestillo de gancho de acero. Cerradero plano de acero inoxidable. Cuadrado 7mm.

Finition/Finish/Acabado

Zingué

Zinc plated

Cincado

Utilisation/Use/Utilización

Porte coulissante de menuiserie métallique

Metal joinerie sliding door

Puertas corredera de carpintería metálica

Designation	Boite	Colis.	Prix	Sachet	Colis.	Prix	Brochable					Colis.	Prix
							France	Euro 1	Euro 2	Euro 3	Euro 4		
Boitier de serrure à cylindre axe 20mm L 36 entraxe 70mm à crochet	00011720	1	-	-	-	-	-	-	-	-	-	-	-

Entraxe 85 mm / À CROCHET À CYLINDRE PROTECT

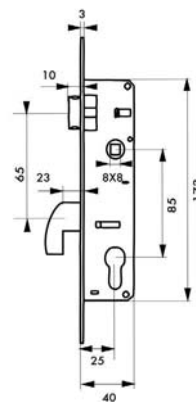

GARANTIE



X 3

Description/Description/Descripción

Coffre acier. Tête acier nickelé. Demi-tour réversible sans démontage. du coffre. Rappel du 1/2 tour par la clé. Pêne alliage nickelé. Gâche acier nickelé. Carré 8 mm, entr'axe 85 mm.

Steel case. Nickel plated steel forend. Reversible latch without removing the case. Draw back of the latch by key.

Nickel plated alloy dead bolt. Nickel plated steel striker. Square 8 mm.

Cabeza de acero. Cabeza de acero niquelado. Media vuelta reversible sin desmontar la caja. Reposición de la

media vuelta con la llave. Pestillo de aleación niquelada. Cerradero de acero niquelado. Cuadrado 8 mm.

Finition/Finish/Acabado

Zingué

Zinc coated

Cincado

Utilisation/Use/Utilización

Porte coulissante de menuiserie métallique

Metal joinerie sliding door

Puertas corredera de carpintería metálica

Designation	Boite	Colis.	Prix	Sachet	Colis.	Prix	Brochable					Colis.	Prix
							France	Euro 1	Euro 2	Euro 3	Euro 4		
Serrure à cylindre profilé axe 25mm L40 entraxe 85mm 3 clés	00094520	1	-	-	-	-	-	-	00494520	-	5	-	

⚠ Non stocké/Non-stored/Producto no estocado - 📦 Sur stock Europe Zone 1 et Zone 2, nous consulter pour délai d'approvisionnement - 📦 Epuisement/Stock depletion/Agotamiento del stock

Entraxe 104 mm / MENTONNET ET A CYLINDRE PROTECT



GARANTIE



X 3

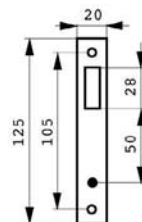
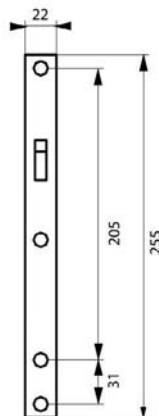
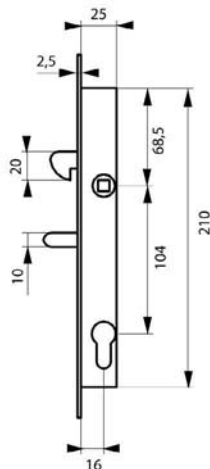

Description/Description/Descripción

Coffre acier. Tête inox. Pêne crochet bronze. Fonction équerre. Gâche plate inox. Carré 8 mm avec fourreau réducteur 7 mm. Entr'axe 104 mm

Steel case. Stainless steel forend. Bronze hook. Function square. Stainless steel flat striker. Square 8 mm with spindle sleeve 7 mm. Nylon spindle slave 7 mm

Caja de acero. Cabeza de acero inoxidable. Pestillo de gancho de bronce. Función escuadra. Cerradero plano de acero inoxidable. Cuadrado 8 mm con funda reductora de 7 mm. Funda de nailon de 7 mm.

Finition/Finish/Acabado

Zingué

Zinc plated

Cincado

Version/Option/Versión

Avec cylindre profilé laiton nickelé 30 x 30 mm panneton réduit., 3 clés.

With nickel plated brass profile cylinder 30 x 30 mm with reduced driver cam, 3 keys.

Con cilindro perfilado de latón niquelado 30 x 30 mm pivote reducido, 3 llaves.

Utilisation/Use/Utilización

Porte coulissante de menuiserie métallique.

Metal joinerie, sliding door.

Puertas corredera de carpintería metálica.

Designation	Boite	Colis.	Prix	Sachet	Colis.	Prix	Brochable					Colis.	Prix
							France	Euro 1	Euro 2	Euro 3	Euro 4		
Serrure à cylindre profilé axe 16mm L 25 entraxe 104mm à mentonnet 3 clés	00002825	5	-	00902825	10	-	00402825	-	-	-	-	5	-
Boitier de serrure à cylindre panneton réduit axe 16mm L 25 entraxe 104mm à mentonnet	00012825	5	-	-	-	-	00412825	-	-	-	-	5	-

Non stocké/Non-stored/Producto no estocado - Sur stock Europe Zone 1 et Zone 2, nous consulter pour délai d'approvisionnement - Epuement/Stock depletion/Agotamiento del stock

Axe à 40 mm / BEC DE CANE

ECO



GARANTIE

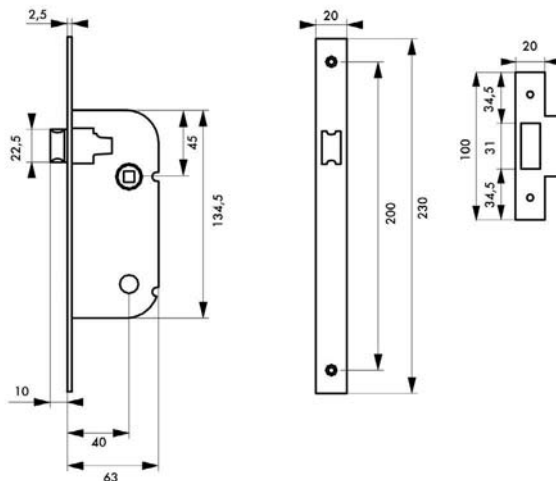

Description/Description/Descripción

Coffre acier embouti. Tête acier. Demi-tour alliage réversible sans. démontage du coffre. Gâche plate acier. Carré 7 mm.

Stamped steel case. Steel forend. Reversible alloy latch without. removing the case. Steel flat striker - Square 7 mm.

Caja de acero embutido. Cabeza de acero. Media vuelta de aleación. reversible sin desmontar la caja. Cerradero plano de acero. Cuadrado 7 mm.

Finition/Finish/Acabado

Epoxy blanc (V) - Zingué blanc (ZB)

White epoxy (V) - White zinc plated (ZB)

Epoxi blanco (V) - Cincado blanco (ZB)

Version/Option/Versión

Tête bouts carrés (BC) - Tête bouts ronds (BR)

Square (BC) - Round (BR) ended forend

Cabeza de extremos cuadrados (BC) - Cabeza de extremos redondos (BR)

Utilisation/Use/Utilización

Porte isoplane < 40 kg, (NON GARANTIE EN CAS DE CONTRE BEQUILLAGE)

Door < 40 kg

Puerta < 40 kg

Designation	Boite	Colis.	Prix	Sachet	Colis.	Prix	Brochable					Colis.	Prix
							France	Euro 1	Euro 2	Euro 3	Euro 4		
Serrure axe 40mm bec de cane réversible V/BC	-	-	-	-	-	-	00400100	-	-	-	-	10	-
Serrure axe 40mm bec de cane réversible V/BR	-	-	-	00901100	30	-	00401100	-	-	-	-	10	-
Serrure axe 40mm bec de cane réversible Z/BR	-	-	-	00911100	30	-	00411100	-	-	-	-	10	-

Tarif conditionnement non décolisable

Serrure axe 40mm bec de cane V/BR sans gâche - droite (50 pièces non décolisable)	00081109	50	-	-	-	-	-	-	-	-	-	-	-
Serrure axe 40mm bec de cane V/BR sans gâche - gauche (50 pièces non décolisable)	00081110	50	-	-	-	-	-	-	-	-	-	-	-
Gache type Eco (50 pièces non décolisable)	00081003	50	-	-	-	-	-	-	-	-	-	-	-

Ⓜ Non stocké/Non-stored/Producto no estocado - Ⓜ Sur stock Europe Zone 1 et Zone 2, nous consulter pour délai d'approvisionnement - Ⓜ Epuisement/Stock depletion/Agotamiento del stock

Axe à 40 mm / BEC DE CANE ECO

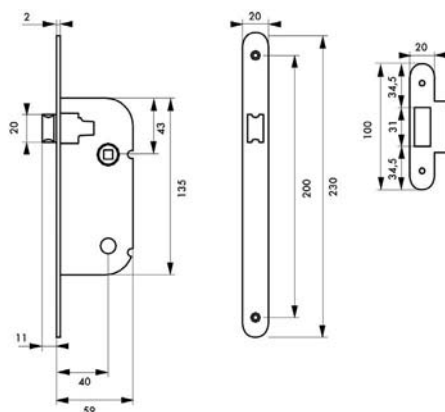

GARANTIE

Pêne 1/2 tour et
fouillot 7mm nylon

Description/Description/Descripción

Coffre acier embouti. Têtière acier bouts ronds ép.2mm.
Demi-tour nylon réversible sans démontage du coffre.
Gâche plate acier. Carré nylon 7 mm.

*Stamped steel case. Steel forend. Reversible nylon latch
without removing the case. Steel at striker. Nylon square
7 mm.*

Caja de acero embutido. Cabeza de acero, espesor 2mm.

Media vuelta de nylon reversible sin desmontar la caja. Cerradero plano de acero. Cuadrado de nylon 7 mm.

Finition/Finish/Acabado

Epoxy blanc.

White epoxy.

Epoxi blanco.

Designation	Boîte	Colis.	Prix	Sachet	Colis.	Prix	Brochable					Colis.	Prix
							France	Euro 1	Euro 2	Euro 3	Euro 4		
Tarif conditionnement non décollable													
Serrure Eco axe à 40mm bec de cane réversible V/BR (50 pièces non décollable)	00053190	50	-	-	-	-	-	-	-	-	-	-	-

Axe à 40 mm / MAGNETIQUE, BEC DE CANE PROTECT



CONFORT D'UTILISATION : - silence de fonctionnement - pas de pêne en saillie

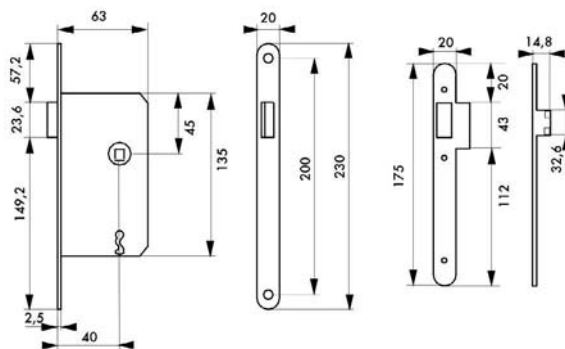

GARANTIE

Description/Description/Descripción

Coffre acier embouti. Têtière acier bouts ronds. Système magnétique à pêne rétractable. Gâche plate acier. Carré 7 mm.

Pressed steel safe. Steel rounded head forend. Magnetic system with retractable bolt. Steel flat strike. Square 7 mm.

Caja de acero embutido. Cabeza de acero extremos

redondos. Sistema magnético de pestillo retraíble. Gacheta plana de acero. Cuadrado 7 mm.

Finition/Finish/Acabado

Fer satiné

Satin iron

Hierro satinado

Designation	Boîte	Colis.	Prix	Sachet	Colis.	Prix	Brochable					Colis.	Prix
							France	Euro 1	Euro 2	Euro 3	Euro 4		
Serrure axe 40mm magnétique bec de cane /BR	00001150	1	-	-	-	-	00401150	-	-	-	-	5	-

⊗ Non stocké/Non-stored/Producto no estocado - ⊗ Sur stock Europe Zone 1 et Zone 2, nous consulter pour délai d'approvisionnement - ⊗ Epuisement/Stock depletion/Agotamiento del stock

Axe à 40 mm / BEC DE CANE PROTECT



GARANTIE

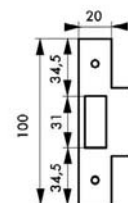
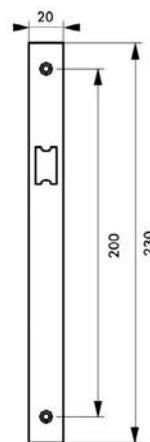
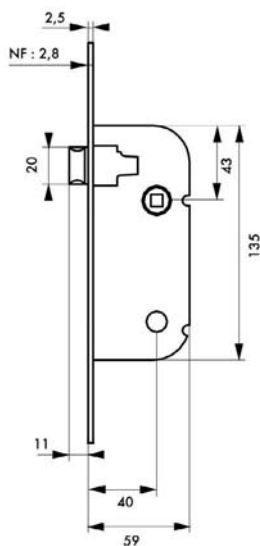

Description/Description/Descripción

Coffre acier embouti. Têtière inox. Demi-tour alliage réversible sans démontage du coffre. Gâche plate inox. Carré 7 mm.

Stamped steel case. Sainless steel forend. Reversible alloy latch without removing the case. Stainless steel flat striker. Square 7 mm.

Caja de acero embutido. Cabeza de acero inoxidable. Media vuelta de aleación reversible sin desmontar la caja. Cerradero plano de acero inoxidable. Cuadrado 7 mm.

Zingué
Zinc plated
Cincado

Designation	Boite	Colis.	Prix	Sachet	Colis.	Prix	Brochable					Colis.	Prix
							France	Euro 1	Euro 2	Euro 3	Euro 4		
Serrure axe à 40mm bec de cane BR tète inox avec gâche	-	-	-	00982110	10	-	00482110	-	-	-	-	5	-
Tarif conditionnement non décollable													
Serrure axe à 40mm bec de cane BR tète inox sans gâche (50 pièces non décollable)	00082110	50	-	-	-	-	-	-	-	-	-	-	-
Gâche inox (50 pièces non décollable)	00082000	50	-	-	-	-	-	-	-	-	-	-	-

⚠ Non stocké/Non-stored/Producto no estocado - 📦 Sur stock Europe Zone 1 et Zone 2, nous consulter pour délai d'approvisionnement - 📦 Epuisement/Stock depletion/Agotamiento del stock

Axe à 40 mm / BEC DE CANE

PROTECT



GARANTIE

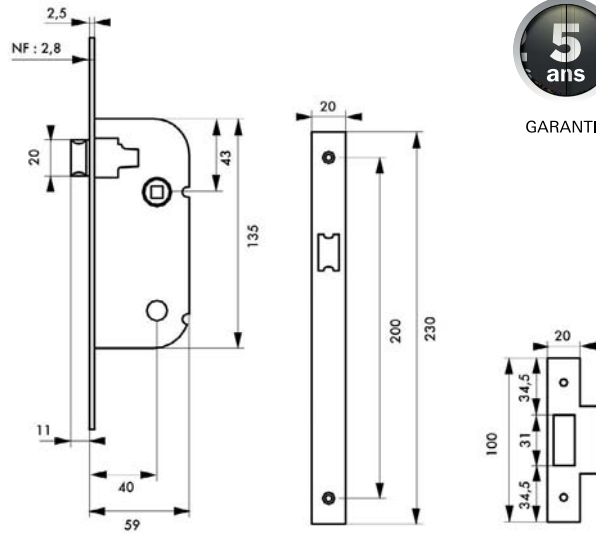

Description/Description/Descripción

Coffre acier embouti. Têtière acier. Demi-tour alliage réversible sans démontage du coffre. Gâche plate acier. Carré 7 mm.

Stamped steel case. Steel forend. Reversible alloy latch without removing the case. Steel flat striker - Square 7 mm.

Caja de acero embutido. Cabeza de acero. Media vuelta de aleación. reversible sin desmontar la caja. Cerradero plano de acero. Cuadrado 7 mm.

Finition/Finish/Acabado

Epoxy blanc (V) - Zingué (Z)

White epoxy (V) - Zinc plated (Z)

Epoxi blanco (V) - Cincado (Z)

Version/Option/Versión

Fouillot 6 x 9 mm. Têtière bouts carrés (BC). Têtière bouts ronds (BR). Coloris bronze sous conditionnement coque.

Square 6 x 9 mm. Square (BC), round (BR) ended forend.

Cuadrado 6 x 9 mm. Cabeza de extremos cuadrados

(BC). Cabeza de extremos redondos (BR).

Designation	Boite	Colis.	Prix	Sachet	Colis.	Prix	Brochable					Colis.	Prix
							France	Euro 1	Euro 2	Euro 3	Euro 4		
Serrure axe 40mm bec de cane réversible V/BC	00000100	10	-	-	-	-	-	-	-	-	-	-	-
Serrure axe 40mm bec de cane réversible V/BR	00001100	10	-	00901190	10	-	00401190	-	-	-	-	10	-
Serrure axe 40mm bec de cane réversible Z/BC	00010100	10	-	-	-	-	-	-	-	-	-	-	-
Serrure axe 40mm bec de cane réversible Z/BR	00011100	10	-	-	-	-	-	-	-	-	-	-	-
Serrure axe 40mm bec de cane réversible V/BR fouillot 6 x 9 mm	00012190	10	-	-	-	-	-	-	-	-	-	-	-
Clé rectangulaire 9 mm	00013926	10	-	-	-	-	-	-	-	-	-	-	-

Tarif conditionnement non décolisable

Serrure axe 40mm bec de cane réversible V/BC (50 pièces non décolisable)	00050190	50	-	-	-	-	-	-	-	-	-	-	-
Serrure axe 40mm bec de cane réversible V/BR (50 pièces non décolisable)	00051190	50	-	-	-	-	-	-	-	-	-	-	-
Serrure axe 40mm bec de cane réversible V/BR fouillot 6 x 9 mm - livré sans gâche (50 pièces non décolisable)	00052190	50	-	-	-	-	-	-	-	-	-	-	-

Non stocké/Non-stored/Producto no estocado - Sur stock Europe Zone 1 et Zone 2, nous consulter pour délai d'approvisionnement - Epuisement/Stock depletion/Agotamiento del stock



Axe à 40 mm / BEC DE CANE

RESIST



GARANTIE



niveau 1

Spécifications dimensionnelles selon la norme NF P 26-409

EN 12209

Classification

2B400F-H020

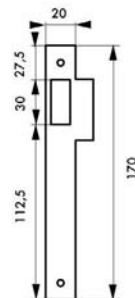
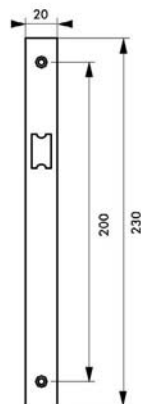
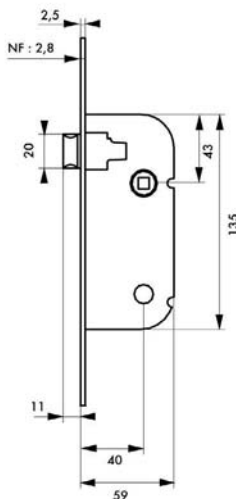

Caractéristiques certifiées NF : endurance, durabilité, sécurité.

Description/Description/Descripción

Coffre acier embouti. Têtière acier. Demi-tour alliage réversible sans démontage du coffre. Gâche plate acier. Carré 7 mm.

Stamped steel case. Steel forend. Reversible alloy latch without removing the case. Steel flat striker. Square 7 mm. Caja de acero embutido. Cabeza de acero. Media vuelta de aleación reversible sin desmontar la caja. Cerradero plano de acero. Cuadrado 7 mm.

Finition/Finish/Acabado

Epoxy noir (V) - Zingué (Z)
Black epoxy (V) - Zinc plated (Z)
Epoxi negro (V) - Cincado (Z)

Version/Option/Versión

Têtière bouts carrés (BC) - Têtière bouts ronds (BR)
Square (BC) - Round (BR) ended forend
Cabeza de extremos cuadrados (BC) - Cabeza de extremos redondos (BR)

Designation	Boite	Colis.	Prix	Sachet	Colis.	Prix	Brochable					Colis.	Prix
							France	Euro 1	Euro 2	Euro 3	Euro 4		
Serrure axe 40mm NF bec de cane réversible V/BC noir	00000500	10	-	-	-	-	00400500	-	-	-	-	10	-
Serrure axe 40mm NF bec de cane réversible V/BR noir	00001500	10	-	00901500	10	-	00401500	-	-	-	-	10	-
Serrure axe 40mm NF bec de cane réversible V/BR blanc	00061500	10	-	00901500	10	-	00401500	-	-	-	-	10	-
Serrure axe 40mm NF bec de cane réversible Z/BC	00010500	10	-	-	-	-	-	-	-	-	-	-	-
Serrure axe 40mm NF bec de cane réversible Z/BR	00011500	10	-	-	-	-	-	-	-	-	-	-	-
Tarif conditionnement non décolisable													
Serrure axe 40mm NF bec de cane réversible V/BC (50 pièces non décolisable)	00050500	50	-	-	-	-	-	-	-	-	-	-	-
Serrure axe 40mm NF bec de cane réversible V/BR noir (50 pièces non décolisable)	00051500	50	-	-	-	-	-	-	-	-	-	-	-
Serrure axe 40mm NF bec de cane réversible V/BR blanc (50 pièces non décolisable)	00151500	50	-	-	-	-	-	-	-	-	-	-	-

Non stocké/Non-stored/Producto no estocado - Sur stock Europe Zone 1 et Zone 2, nous consulter pour délai d'approvisionnement - Epuisement/Stock depletion/Agotamiento del stock

Axe à 40 mm / BEC DE CANE

RESIST



Caractéristiques certifiées NF :
endurance, durabilité, sécurité.

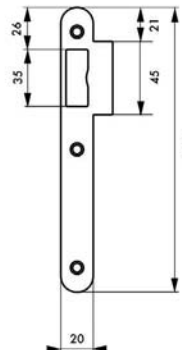
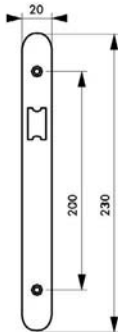
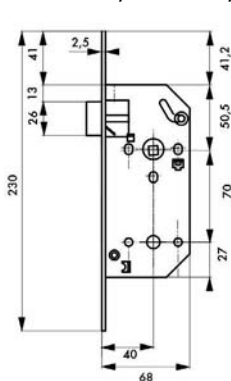

GARANTIE



niveau 2

Essais selon la
norme NF
EN 12209

Classification

3S400G-H030

Description/Description/Descripción

Coffre acier embouti. Tête acier bouts ronds. Demi-tour bipente alliage réversible sans démontage du coffre. Gâche plate acier zingué. Carré 7 mm.

Stamped steel case. Round ended steel forend. Reversible alloy latch without removing the case. Zinc plated steel flat striker. Square 7 mm.

Caja de acero embutido. Cabeza de extremos redondos. Media vuelta de aleación. reversible sin desmontar la caja. Cerradero plano de acero cincado. Cuadrado 7 mm.

Finition/Finish/Acabado

Coffre galvanisé, tête epoxy noir granité ou nickelé

Case galvanised, forend black epoxy

Caja galvanizado, cabeza epoxy negro

Version/Option/Versión

Tête inox, acier laitonné, acier nickelé. Possibilité carré 8 mm sur demande.

Stainless steel forend, brass plated forend, nickel plated forend. Square 8 mm on request.

Cabeza de acero inoxidable, acero latonado, acero niquelado. Cuadrado 8 mm a petición.

Designation	Boite	Colis.	Prix	Sachet	Colis.	Prix	Brochable					Colis.	Prix
							France	Euro 1	Euro 2	Euro 3	Euro 4		
Serrure MONOMAX NF axe 40mm bec de cane tête noire BR	00546800	5	-	-	-	-	-	-	-	-	-	-	-
Serrure MONOMAX NF axe 40mm bec de cane tête noire BC	00546900	5	-	-	-	-	-	-	-	-	-	-	-
Serrure MONOMAX NF axe 40mm bec de cane tête inox BR	00546801	5	-	-	-	-	-	-	-	-	-	-	-
Serrure MONOMAX NF axe 40mm bec de cane tête acier laitonné BR	00546802	5	-	-	-	-	-	-	-	-	-	-	-
Serrure MONOMAX NF axe 40mm bec de cane tête acier nickelé BR	00546803	5	-	-	-	-	-	-	-	-	-	-	-

Tarif conditionnement non décollable

Serrure MONOMAX NF axe 40mm bec de cane tête noire BR sans gâche (25 pièces non décollable)	00046800	25	-	-	-	-	-	-	-	-	-	-	-
Serrure MONOMAX NF axe 40mm bec de cane tête inox BR sans gâche (25 pièces non décollable)	00046801	25	-	-	-	-	-	-	-	-	-	-	-
Gâche acier pour serrure NORME N.F bec de cane (25 pièces non décollable)	00046100	25	-	-	-	-	-	-	-	-	-	-	-
Gâche acier pour serrure NORME NF à pêne dormant ½ tour (25 pièces non décollable)	00046102	25	-	-	-	-	-	-	-	-	-	-	-
Gâche inox pour serrure NORME N.F bec de cane (25 pièces non décollable)	00046101	25	-	-	-	-	-	-	-	-	-	-	-

Tarif garniture

Garniture MONOMAX NF tête noire BR + ensemble HERA	00022140	30	-	-	-	-	-	-	-	-	-	-	-
Garniture MONOMAX NF tête noire BR + ensemble THALIA	00022150	30	-	-	-	-	-	-	-	-	-	-	-

Non stocké/Non-stored/Producto no estocado - Sur stock Europe Zone 1 et Zone 2, nous consulter pour délai d'approvisionnement - Epuisement/Stock depletion/Agotamiento del stock

Axe à 50 mm / BEC DE CANE ECO



GARANTIE

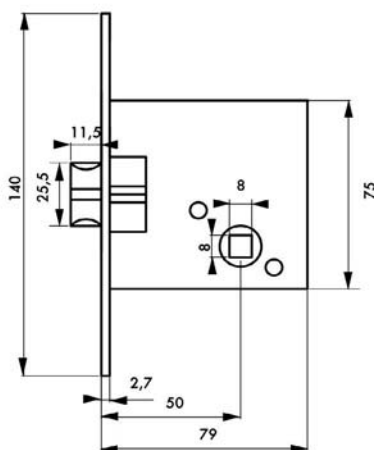

Description/Description/Descripción

Coffre acier embouti. Tête à acier carrés. Demi-tour réversible sans démontage du coffre. Gâche plate acier. Carré 8 mm.

Stamped steel case. Steel forend. Reversible latch without removing the case. Steel flat striker. Square 8 mm.

Caja de acero embutido. Cabeza de acero. Media vuelta reversible sin desmontar la caja. Cerradero plano de acero. Cuadrado 8 mm.

Finition/Finish/Acabado

Zingué
Zinc coated
Cincado

Designation	Boite	Colis.	Prix	Sachet	Colis.	Prix	Brochable					Colis.	Prix
							France	Euro 1	Euro 2	Euro 3	Euro 4		
Serrure axe 50mm bec de cane réversible	00094598	1	-	-	-	-	-	-	-	00494598	-	5	-

⚠ Non stocké/Non-stored/Producto no estocado - 📦 Sur stock Europe Zone 1 et Zone 2, nous consulter pour délai d'approvisionnement - 📦 Epuisement/Stock depletion/Agotamiento del stock

Axe à 50 mm / BEC DE CANE

ECO



GARANTIE



Coffre épaisseur 10mm

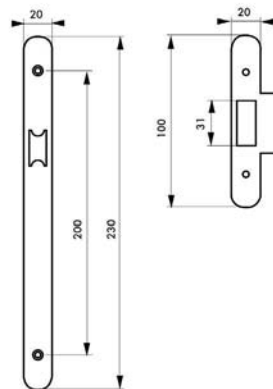
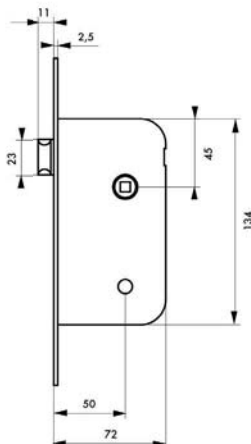

Description/Description/Descripción

Coffre acier embouti épaisseur 10 mm. Tête acier.
 Demi-tour alliage zingué réversible sans démontage du coffre. Gâche plate acier. Carré 7 mm.
Stamped steel case 10 mm thickness. Steel forend. Reversible zinc plated alloy latch without removing the case. Steel flat striker. Square 7 mm.
 Caja de acero embutido 10 mm de espesor. Cabeza de acero. Media vuelta de aleación cincado reversible sin desmontar la caja. Cerradero plano de acero. Cuadrado 7 mm.

Finition/Finish/Acabado

Epoxy blanc (V) Gris métal
White epoxy (V) Metal gray
 Epoxi blanco (V) Metal gris

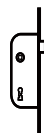

Designation	Boite	Colis.	Prix	Sachet	Colis.	Prix	Brochable					Colis.	Prix
							France	Euro 1	Euro 2	Euro 3	Euro 4		
Serrure axe 50 mm bec de cane coffre épaisseur 10 mm blanc/BR	-	-	-	-	-	-	00413930	-	-	-	-	5	-
Serrure axe 50 mm bec de cane coffre épaisseur 10 mm gris métal/BR	-	-	-	00913933	10	-	-	-	-	-	-	-	-
Tarif conditionnement non décolisable													
Serrure axe 50 mm bec de cane coffre épaisseur 10 mm blanc/BR (50 pièces non décolisable)	00013930	50	-	-	-	-	-	-	-	-	-	-	-
Serrure axe 50 mm bec de cane coffre épaisseur 10 mm gris métal/BR (50 pièces non décolisable)	00013933	50	-	-	-	-	-	-	-	-	-	-	-

Ⓜ Non stocké/Non-stored/Producto no estocado - Ⓜ Sur stock Europe Zone 1 et Zone 2, nous consulter pour délai d'approvisionnement - Ⓜ Epuisement/Stock depletion/Agotamiento del stock

Axe à 50 mm / BEC DE CANE ECO

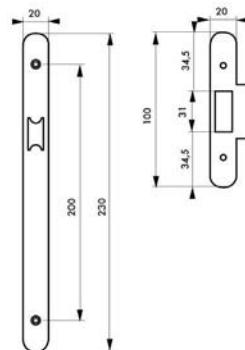
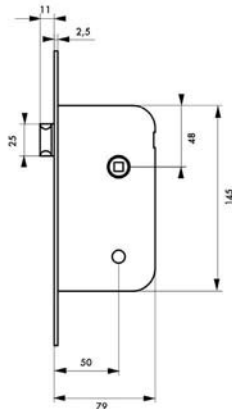

GARANTIE

Description/Description/Descripción

Coffre acier embouti épaisseur 11 mm. Tête acier bouts ronds. Demi-tour alliage réversible sans démontage du coffre. Gâche plate acier. Carré 7 mm.

Stamped steel case thickness 11 mm. Steel forend. Reversible alloy latch without removing the case. Steel flat striker. Square 7 mm.

Caja de acero embutido espesor 11 mm. Cabeza de acero. Media vuelta de aleación reversible sin desmontar la caja. Cerradero plano de acero. Cuadrado 7 mm.

Finition/Finish/Acabado

Epoxy noir granité (V)

Black epoxy (V)

Epoxi negro granitado (V)

Designation	Boite	Colis.	Prix	Sachet	Colis.	Prix	Brochable					Colis.	Prix
							France	Euro 1	Euro 2	Euro 3	Euro 4		
Serrure axe 50 mm bec de cane V/BR/Z	-	-	-	00901200	10	-	00401200	-	-	-	-	10	-

Axe à 50 mm / MAGNETIQUE, BEC DE CANE PROTECT

CONFORT D'UTILISATION : silence de fonctionnement - pas de pêne en saillie

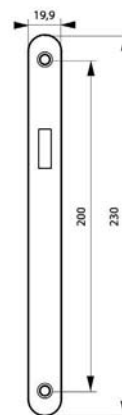
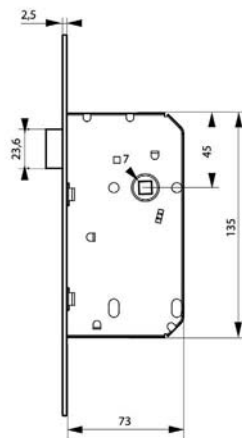

GARANTIE

Description/Description/Descripción

Coffre acier embouti. Tête acier bouts ronds. Système magnétique à pêne rétractable. Gâche plate acier. Carré 7 mm.

Pressed steel safe. Steel rounded head forend. Magnetic system with retractable bolt. Steel flat strike. Square 7 mm.

Caja de acero embutido. Cabeza de acero extremos redondos. Sistema magnético de pestillo retraíble. Gacheta plana de acero. Cuadrado 7 mm.

Finition/Finish/Acabado

Fer satiné

Satin iron

Hierro satinado

Designation	Boite	Colis.	Prix	Sachet	Colis.	Prix	Brochable					Colis.	Prix
							France	Euro 1	Euro 2	Euro 3	Euro 4		
Serrure axe 50mm magnétique bec de cane	-	-	-	00901550	10	-	00401550	-	-	-	-	5	-

Ⓜ Non stocké/Non-stored/Producto no estocado - ☑ Sur stock Europe Zone 1 et Zone 2, nous consulter pour délai d'approvisionnement - ☒ Epuisement/Stock depletion/Agotamiento del stock

Axe à 50 mm / BEC DE CANE

ECO



GARANTIE

Tête amovible et nombreuses finitions disponibles

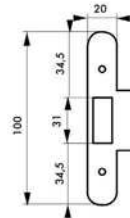
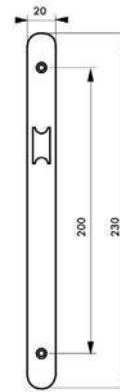
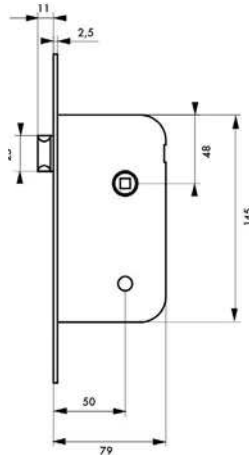

Description/Description/Descripción

Coffre acier embouti. Tête acier. Demi-tour alliage réversible sans démontage du coffre. Gâche plate acier. Carré 7 mm.

Stamped steel case. Steel forend. Reversible alloy latch without removing the case. Steel flat striker. Square 7 mm. Caja de acero embutido. Cabeza de acero. Media vuelta de aleación reversible sin desmontar la caja. Cerradero plano de acero. Cuadrado 7 mm.

Finition/Finish/Acabado

Tête époxy noir, nickelé, laiton brossé, laiton poli verni, poli nickelé.

Black epoxy, nickel plated, brushed brass, polished brass, polished nickel plated forend.

Cabeza epoxi negro, niquelado, latón cepillado, latón pulido barnizado, pulido niquelado.

Version/Option/Versión

Tête bouts carrés (BC) - Tête bouts ronds (BR)

Square (BC) - Round (BR) ended forend

Cabeza de extremos cuadrados (BC) - Cabeza de extremos redondos (BR)

Designation	Boite	Colis.	Prix	Sachet	Colis.	Prix	Brochable					Colis.	Prix
							France	Euro 1	Euro 2	Euro 3	Euro 4		
Serrure axe 50 mm bec de cane V/BC/Z	00000200	5	-	-	-	-	-	-	-	-	-	-	-
Serrure axe 50 mm bec de cane V/BR/Z	00001200	5	-	-	-	-	-	-	-	-	-	-	-
Serrure axe 50 mm bec de cane tête acier nickelé V/BR/L	00019320	5	-	-	-	-	-	-	-	-	-	-	-
Serrure axe 50 mm bec de cane Z/BC/Z	00010200	5	-	-	-	-	-	-	-	-	-	-	-
Serrure axe 50 mm bec de cane Z/BR/Z	00011200	5	-	-	-	-	-	-	-	-	-	-	-
Serrure axe 50 mm bec de cane tête laiton brossé V/BR/L	00019500	5	-	-	-	-	-	-	-	-	-	-	-
Serrure axe 50 mm bec de cane tête laiton poli verni V/BR/L	00019220	5	-	-	-	-	-	-	-	-	-	-	-
Serrure axe 50 mm bec de cane tête laiton poli nickelé V/BR/L	00019210	5	-	-	-	-	-	-	-	-	-	-	-
Serrure axe 50 mm bec de cane tête inox V/BR/L	00019240 ^{NS}	5	-	-	-	-	-	-	-	-	-	-	-

^{NS} Non stocké/Non-stored/Producto no estocado - Sur stock Europe Zone 1 et Zone 2, nous consulter pour délai d'approvisionnement - Epuisement/Stock depletion/Agotamiento del stock

Axe à 50 mm / BEC DE CANE

RESIST



Caractéristiques certifiées NF :
endurance, durabilité, sécurité.

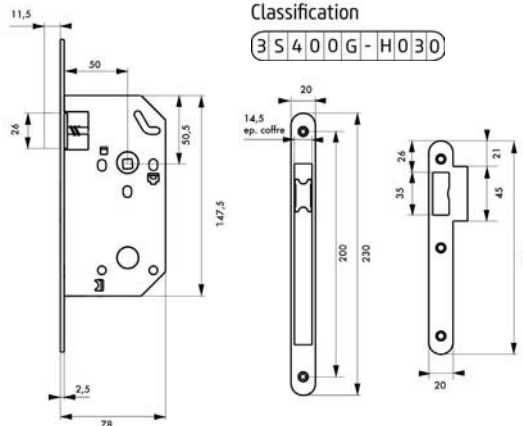

Essais selon la norme NF
EN 12209

Classification

3 5 4 0 0 G - H 0 3 0



GARANTIE

Description/Description/Descripción

Coffre acier embouti. Tête acier bouts ronds. Demi-tour bipente alliage réversible sans démontage du coffre. Gâche plate acier zingué. Carré 7 mm.
Stamped steel case. Round ended steel forend. Reversible alloy latch without removing the case. Zinc plated steel flat striker. Square 7 mm.

Caja de acero embutido. Cabeza de extremos redondos. Media vuelta de aleación reversible sin desmontar la caja. Cerradero plano de acero cincado. Cuadrado 7 mm.

Finition/Finish/Acabado

Coffre galvanisé, tête epoxy noir granité
Case galvanised, forend black epoxy
Caja galvanizado, cabeza epoxy negro

Versión/Option/Versión

Tête inox, acier laitonné, acier nickelé. Possibilité carré 8 mm sur demande.
Stainless steel forend, brass plated forend, nickel plated forend. Square 8 mm on request.
Cabeza de acero inoxidable, acero latonado, acero niquelado. Cuadrado 8 mm a petición.

Designation	Boite	Colis.	Prix	Sachet	Colis.	Prix	Brochable					Colis.	Prix
							France	Euro 1	Euro 2	Euro 3	Euro 4		
Serrure MONOMAX NF axe 50 mm bec de cane tête noire BR	00556800	5	-	00956800	20	-	00456800	-	-	-	-	5	-
Serrure MONOMAX NF axe 50 mm bec de cane tête noire BC	00556900	5	-	-	-	-	-	-	-	-	-	-	-
Serrure MONOMAX NF axe 50 mm bec de cane tête inox BR	00556801	5	-	-	-	-	00456801	-	-	-	-	5	-
Serrure MONOMAX NF axe 50 mm bec de cane tête acier laitonné BR	00556802	5	-	-	-	-	-	-	-	-	-	-	-
Serrure MONOMAX NF axe 50 mm bec de cane tête acier nickelé BR	00556803	5	-	-	-	-	-	-	-	-	-	-	-

Tarif conditionnement non décolisable

Serrure MONOMAX NF axe 50 mm bec de cane tête noire BR sans gâche (25 pièces non décolisable)	00056800	25	-	-	-	-	-	-	-	-	-	-	-
Gâche acier pour serrure NORME N.F bec de cane (25 pièces non décolisable)	00046100	25	-	-	-	-	-	-	-	-	-	-	-
Serrure MONOMAX NF axe 50 mm bec de cane tête inox BR sans gâche (25 pièces non décolisable)	00056801	25	-	-	-	-	-	-	-	-	-	-	-
Gâche inox pour serrure NORME N.F bec de cane (25 pièces non décolisable)	00046101	25	-	-	-	-	-	-	-	-	-	-	-

Ⓜ Non stocké/Non-stored/Producto no estocado - Ⓜ Sur stock Europe Zone 1 et Zone 2, nous consulter pour délai d'approvisionnement - Ⓜ Epuisement/Stock depletion/Agotamiento del stock

Axe à 50 mm / BEC DE CANE

RESIST

Caractéristiques certifiées NF :
endurance, durabilité, sécurité.



Spécifications dimensionnelles
selon la norme NF P 26-414

Essais selon la norme NF

EN 12209:2003+AC:2005

Classification

3 B 4 1 0 G - H 0 3 0



Apte à équiper un bloc-porte
résistant au feu

Homologation par le laboratoire EFECTIS



GARANTIE

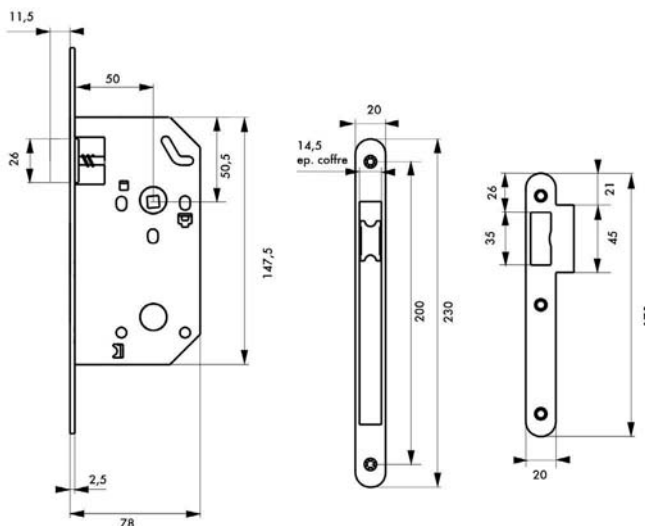

Description/Description/Descripción

Coffre acier embouti galvanisé. Têtière acier bouts ronds.
Demi-tour bipente laiton réversible sans démontage du
coffre. Gâche plate acier zingué. Carré 7 mm.

Stamped steel case. Steel forend. Reversible brass latch
without removing the case. Steel flat striker. Square 7 mm.

Caja de acero embutido. Cabeza de acero. Media vuelta
de latón reversible sin desmontar la caja. Cerradero plano
de acero. Cuadrado 7 mm.

Finition/Finish/Acabado

Coffre galvanisé, têtière noir granité
Case galvanised, forend black epoxy
Caja galvanizado, cabeza epoxi negro

Version/Option/Versión

Têtière laitonée. Têtière nickelé. Têtière inox. Possibilité ?
8 mm sur demande.

Brass plated forend. Nickel plated steel forend. Stainless
steel forend.

Cabeza latonado. Cabeza de acero niquelado. Cabeza de
acero inoxidable.

Designation	Boite	Colis.	Prix	Sachet	Colis.	Prix	Brochable					Colis.	Prix
							France	Euro 1	Euro 2	Euro 3	Euro 4		
Serrure UNIMAX CE NF QC axe 50mm bec de cane têtière noire BR	00015200	5	-	-	-	-	-	-	-	-	-	-	-
Serrure UNIMAX CE NF QC axe 50mm bec de cane têtière laitonée BR	00015230	5	-	-	-	-	-	-	-	-	-	-	-
Serrure UNIMAX CE NF QC axe 50mm bec de cane têtière nickelée BR	00015220	5	-	-	-	-	-	-	-	-	-	-	-
Serrure UNIMAX CE NF QC axe 50mm bec de cane têtière inox BR	00015240	5	-	-	-	-	-	-	-	-	-	-	-

Non stocké/Non-stored/Producto no estocado - Sur stock Europe Zone 1 et Zone 2, nous consulter pour délai d'approvisionnement - Epuement/Stock depletion/Agotamiento del stock

Axe à 60 mm / BEC DE CANE

PROTECT



GARANTIE

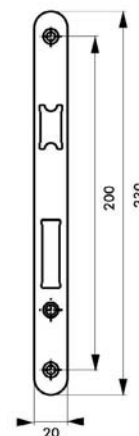
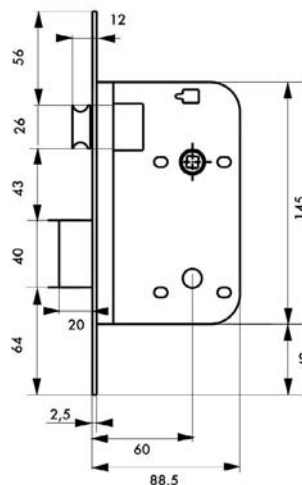

Description/Description/Descripción

Coffre acier embouti. Têtière laiton. 1/2 tour laiton réversible sans démontage du coffre. Carré 7 mm. Gâche plate selon finition.

Stamped steel case. Brass forend. Reversible brass latch without removing the case. Square 7 mm. Flat striker.

Caja de acero embutido. Cabeza de latón. Media vuelta de latón reversible sin desmontar la caja. Cuadrado 7 mm. Cerradero plano.

Finition/Finish/Acabado

Epoxy noir. Têtière laiton brossé. Têtière laiton poli verni. Têtière nickelé. Têtière noire.

Black epoxy. Brushsed brass forend - Black forend. Polished brass forend - Nickel forend

Epoxi negro. Cabeza de latón cepillado. Cabeza de latón pulido barnizado. Cabeza niquelada - Cabeza negro

Versión/Option/Versión

A condamnation. A cylindre profilé.

With locking for bathroom. With profile cylinder.

De condenación. De cilindro perfilado

Designation	Boite	Colis.	Prix	Sachet	Colis.	Prix	Brochable					Colis.	Prix
							France	Euro 1	Euro 2	Euro 3	Euro 4		
Serrure axe 60 mm bec de cane têtère laiton brossé V/BR/L	00009310	5	-	-	-	-	-	-	-	-	-	-	-
Serrure axe 60 mm bec de cane têtère laiton poli verni V/BR/L	00019300	5	-	-	-	-	-	-	-	-	-	-	-
Serrure axe 60 mm bec de cane têtère laiton poli nickelé V/BR/L	00019390	5	-	-	-	-	-	-	-	-	-	-	-
Serrure axe 60 mm bec de cane têtère noire V/BR/L	00019350	5	-	-	-	-	-	-	-	-	-	-	-

⚠ Non stocké/Non-stored/Producto no estocado - 📦 Sur stock Europe Zone 1 et Zone 2, nous consulter pour délai d'approvisionnement - 📦 Epuisement/Stock depletion/Agotamiento del stock

Axe à 70 mm / BEC DE CANE

PROTECT



GARANTIE

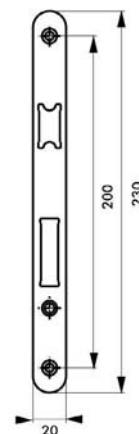
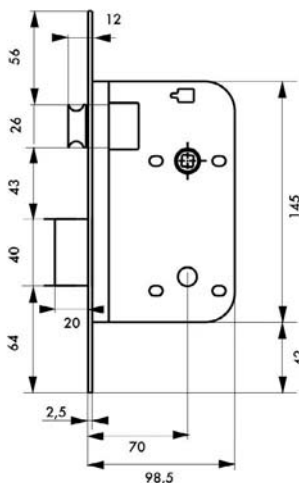

Description/Description/Descripción

Coffre acier embouti. Têtière laiton. 1/2 tour laiton réversible sans démontage du coffre. Carré 7 mm. Gâche plate selon finition.

Stamped steel case. Brass forend. Reversible brass latch without removing the case. Square 7 mm. Flat striker.

Caja de acero embutido. Cabeza de latón. Media vuelta de latón reversible sin desmontar la caja. Cuadrado 7 mm. Cerradero plano.

Finition/Finish/Acabado

Epoxy noir. Têtière laiton brossé. Têtière laiton poli verni. Têtière nickelé. Têtière noire.

Black epoxy. Brushsed brass forend - Black forend. Polished brass forend - Nickel forend

Epoxi negro. Cabeza de latón cepillado. Cabeza de latón pulido barnizado. Cabeza niquelado - Cabeza negro

Version/Option/Versión

A condamnation. A cylindre profilé.

With locking for bathroom. With profile cylinder.

De condenación. De cilindro perfilado

Designation	Boite	Colis.	Prix	Sachet	Colis.	Prix	Brochable					Colis.	Prix
							France	Euro 1	Euro 2	Euro 3	Euro 4		
Serrure axe 70 mm bec de cane têtère laiton brossé V/BR/L	00007200	5	-	-	-	-	-	-	-	-	-	-	-
Serrure axe 70 mm bec de cane têtère laiton poli verni V/BR/L	00007290	10	-	-	-	-	-	-	-	-	-	-	-
Serrure axe 70 mm bec de cane têtère laiton poli nickelé V/BR/L	00017290	5	-	-	-	-	-	-	-	-	-	-	-
Serrure axe 70 mm bec de cane têtère noire V/BR/L	00017250	5	-	-	-	-	-	-	-	-	-	-	-

Non stocké/Non-stored/Producto no estocado - Sur stock Europe Zone 1 et Zone 2, nous consulter pour délai d'approvisionnement - Epuisement/Stock depletion/Agotamiento del stock

Axe à 80 mm / BEC DE CANE

PROTECT



GARANTIE

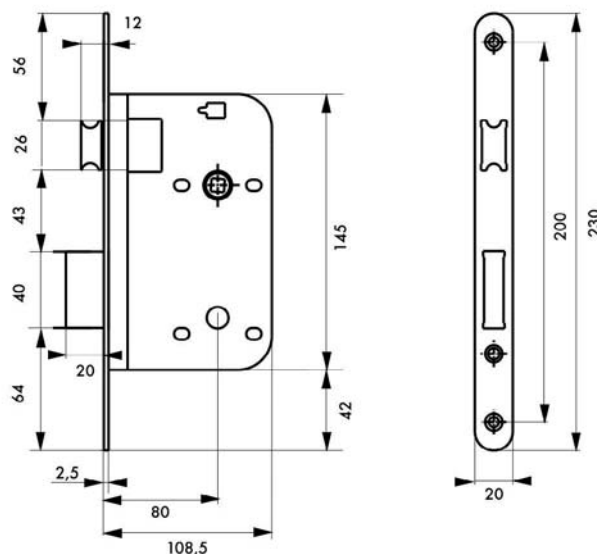

Description/Description/Descripción

Coffre acier embouti. Têtière laiton. 1/2 tour laiton réversible sans démontage du coffre. Carré 7 mm. Gâche plate selon finition.

Stamped steel case. Brass forend. Reversible brass latch without removing the case. Square 7 mm. Flat striker.

Caja de acero embutido. Cabeza de latón. Media vuelta de latón reversible sin desmontar la caja. Cuadrado 7 mm. Cerradero plano.

Finition/Finish/Acabado

Epoxy noir. Têtière laiton poli verni. Têtière nickelé. Têtière noire.

Black epoxy. Polished brass forend - Nickel forend. Black forend.

Epoxi negro. Cabeza de latón pulido barnizado. Cabeza niquelado - Cabeza negro.

Versión/Option/Versión

A condamnation. A cylindre profilé.

With locking for bathroom. With profile cylinder.

De condenación. De cilindro perfilado

Designation	Boite	Colis.	Prix	Sachet	Colis.	Prix	Brochable					Colis.	Prix
							France	Euro 1	Euro 2	Euro 3	Euro 4		
Serrure axe 80 mm bec de cane têtère laiton poli verni V/BR/L	00080290	5	-	-	-	-	-	-	-	-	-	-	-
Serrure axe 80 mm bec de cane têtère laiton poli nickelé V/BR/L	00081290	5	-	-	-	-	-	-	-	-	-	-	-
Serrure axe 80 mm bec de cane têtère noire V/BR/L	00081250	5	-	-	-	-	-	-	-	-	-	-	-

⚠ Non stocké/Non-stored/Producto no estocado - 📦 Sur stock Europe Zone 1 et Zone 2, nous consulter pour délai d'approvisionnement - 📦 Epuisement/Stock depletion/Agotamiento del stock

Axe à 40 mm / A CONDAMNATION

ECO

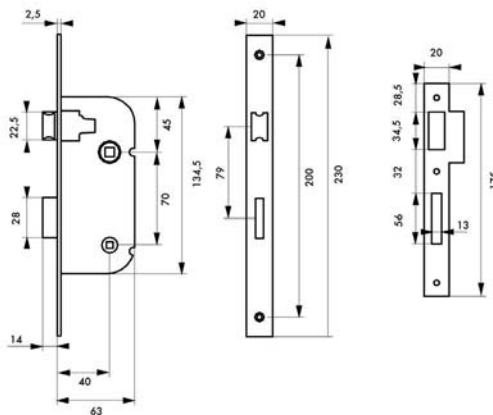

GARANTIE

Description/Description/Descripción

Coffre acier embouti. Tête acier. Demi-tour alliage réversible sans démontage du coffre. Pêne acier. Gâche plate acier. Carré 7 mm, entr'axe 70 mm.

Stamped steel case - Steel forend. Reversible alloy latch without removing the case. Steel bolt. Steel flat striker - Square 7 mm.

Caja de acero embutido. Cabeza de acero. Media vuelta de aleación reversible sin desmontar la caja. Pestillo de acero. Cerradero plano de acero - Cuadrado 7 mm.

Finition/Finish/Acabado

Epoxy blanc (V) - Zingué blanc (ZB)

White epoxy (V) - White zinc plated (ZB)

Epoxi blanco (V) - Cincado blanco (ZB)

Version/Option/Versión

Tête à bouts carrés (BC) - Tête à bouts ronds (BR)

Square (BC) - Round (BR) ended forend

Cabeza de extremos cuadrados (BC) - Cabeza de extremos redondos (BR)

Utilisation/Use/Utilización

Porte isoplane < 40 kg, (NON GARANTIE EN CAS DE CONTRE BEQUILLAGE)

Door < 40 kg

Puerta < 40 kg

Designation	Boîte	Colis.	Prix	Sachet	Colis.	Prix	Brochable					Colis.	Prix
							France	Euro 1	Euro 2	Euro 3	Euro 4		
Serrure axe 40mm à condamnation V/BC	-	-	-	-	-	-	00400101	-	-	-	-	10	-
Serrure axe 40mm à condamnation V/BR	-	-	-	00901101	30	-	00401101	-	-	-	-	10	-
Serrure axe 40mm à condamnation Z/BR	-	-	-	00911101	30	-	00411101	-	-	-	-	10	-

Tarif conditionnement non décolisable

Serrure axe 40mm à condamnation V/BR sans gâche - droite (50 pièces non décolisable)	00081111	50	-	-	-	-	-	-	-	-	-	-	-
Serrure axe 40mm à condamnation V/BR sans gâche - gauche (50 pièces non décolisable)	00081121	50	-	-	-	-	-	-	-	-	-	-	-
Gâche type Eco (50 pièces non décolisable)	00081003	50	-	-	-	-	-	-	-	-	-	-	-

Tarif garniture

Garniture serrure Eco+ axe 40mm à condamnation V/BR + ensemble ARES	00022160	50	-	00922160	50	-	-	-	-	-	-	-	-
Garniture serrure Eco+ axe 40mm à condamnation V/BR + ensemble LETO	00022170	50	-	00922170	50	-	-	-	-	-	-	-	-
Garniture serrure Eco+ axe 40mm à condamnation V/BR + ensemble VESTA	00022180	50	-	00922180	50	-	-	-	-	-	-	-	-
Garniture serrure Eco+ axe 40mm à condamnation V/BR + ensemble DIONYSOS	00022190	50	-	00922190	50	-	-	-	-	-	-	-	-

Non stocké/Non-stored/Producto no estocado - Sur stock Europe Zone 1 et Zone 2, nous consulter pour délai d'approvisionnement - Epuisement/Stock depletion/Agotamiento del stock

Axe à 40 mm / A CONDAMNATION

ECO

Pêne 1/2 tour, fouillot 7mm et condamnation nylon.

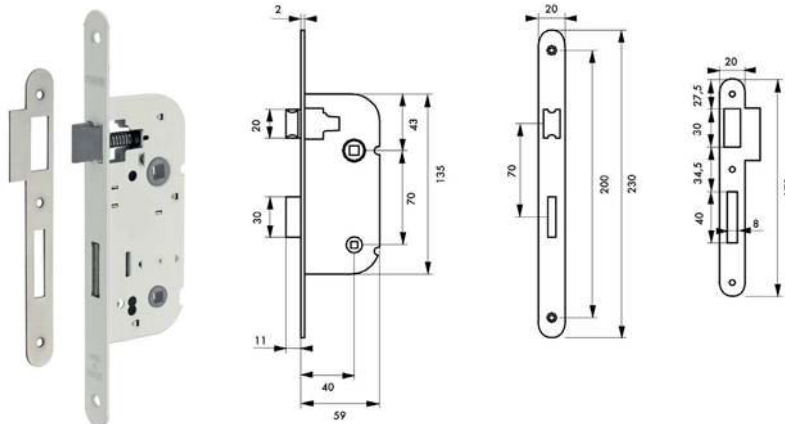

GARANTIE

Description/Description/Descripción

Coffre acier embouti. Tête acier bouts ronds ép.2mm. Demi-tour nylon réversible sans démontage du coffre. Pêne dormant acier. Gâche plate acier. Carré nylon 7 mm, entraxe 70 mm.

Stamped steel case. Steel forend. Reversible nylon latch without removing the case. Steel bolt. Steel at striker. Nylon square 7 mm.

Nylon square 7 mm. Caja de acero embutido. Cabeza de acero de 2mm de espesor. Media vuelta de nylon reversible sin desmontar la caja. Pestillo de acero. Cerradero plano de acero. Cuadrado de nylon 7 mm.

Finition/Finish/Acabado

Epoxy blanc.
White epoxy.
Epoxi blanco.

Designation	Boite	Colis.	Prix	Sachet	Colis.	Prix	Brochable					Colis.	Prix
							France	Euro 1	Euro 2	Euro 3	Euro 4		
Tarif conditionnement non décollable													
Serrure Eco axe à 40mm à condamnation V/BR (50 pièces non décollable)	00053191	50	-	-	-	-	-	-	-	-	-	-	-

Axe à 40 mm / MAGNETIQUE, A CONDAMNATION

PROTECT

CONFORT D'UTILISATION : silence de fonctionnement - pas de pêne en saillie

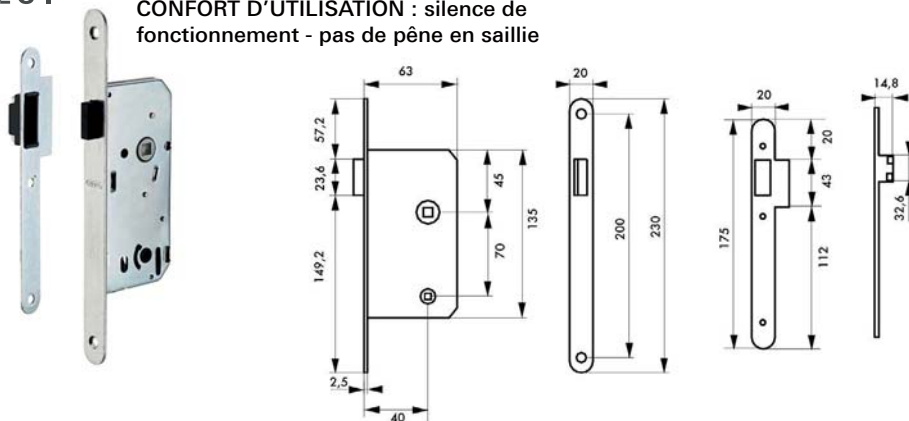

GARANTIE

Description/Description/Descripción

Coffre acier embouti. Tête acier bouts ronds. Système magnétique à pêne rétractable. Gâche plate acier. Carré 7 mm, entr'axe 70 mm.

Pressed steel safe. Steel rounded head forend. Magnetic system with retractable bolt. Steel flat strike. Square 7 mm.

Caja de acero embutido. Cabeza de acero extremos redondos. Sistema magnético de pestillo retraíble. Gacheta plana de acero. Cuadrado 7 mm.

Finition/Finish/Acabado

Fer satiné
Satin iron
Hierro satinado

Designation	Boite	Colis.	Prix	Sachet	Colis.	Prix	Brochable					Colis.	Prix
							France	Euro 1	Euro 2	Euro 3	Euro 4		
Serrure axe 40mm magnétique à condamnation /BR	00001151	1	-	00901151	10	-	00401151	-	-	-	-	5	-

Ⓝ Non stocké/Non-stored/Producto no estocado - Ⓜ Sur stock Europe Zone 1 et Zone 2, nous consulter pour délai d'approvisionnement - Ⓜ Epuisement/Stock depletion/Agotamiento del stock

Axe à 40 mm / A CONDAMNATION PROTECT



GARANTIE

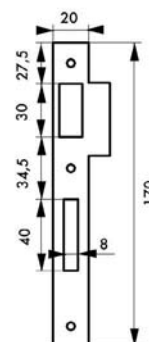
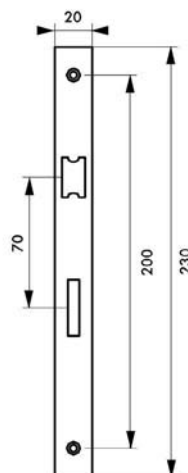
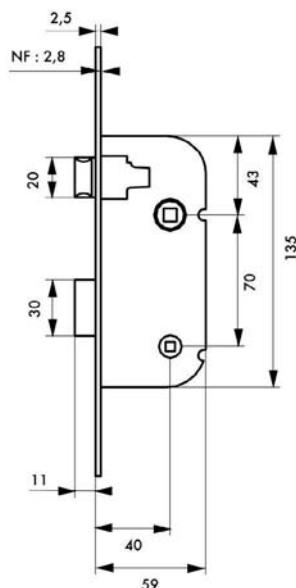

Description/Description/Descripción

Coffre acier embouti. Têtière inox. Demi-tour alliage réversible sans démontage du coffre. Pêne acier. Gâche plate inox. Carré 7 mm, entr'axe 70 mm.

Stamped steel case - Stainless steel forend. Reversible alloy latch without removing the case. Steel bolt. Stainless steel flat striker. Square 7 mm.

Caja de acero embutido. Cabeza de acero inoxidable. Media vuelta de aleación reversible sin desmontar la caja. Pestillo de acero. Cerradero plano de acero inoxidable. Cuadrado 7 mm.

Finition/Finish/Acabado

Zingué
Zinc plated
Cincado



Designation	Boite	Colis.	Prix	Sachet	Colis.	Prix	Brochable					Colis.	Prix
							France	Euro 1	Euro 2	Euro 3	Euro 4		
SERRURE axe 40 mm à condamnation têtière inox BR avec gâche	-	-	-	00982111	10	-	00482111	-	-	-	-	5	-
Tarif conditionnement non décollable													
SERRURE axe 40 mm à condamnation têtière inox BR sans gâche	00082111	50	-	-	-	-	-	-	-	-	-	-	-
Gâche inox	00082001	50	-	-	-	-	-	-	-	-	-	-	-

Non stocké/Non-stored/Producto no estocado - Sur stock Europe Zone 1 et Zone 2, nous consulter pour délai d'approvisionnement - Epuement/Stock depletion/Agotamiento del stock

Axe à 40 mm / A CONDAMNATION

PROTECT



GARANTIE

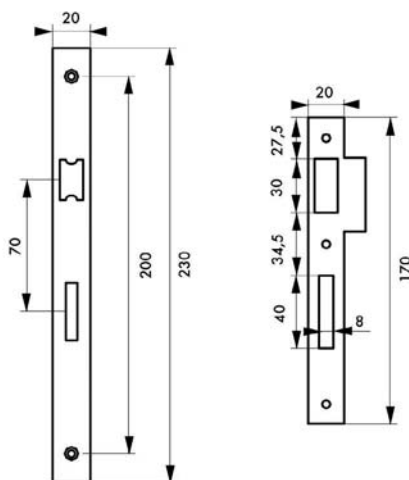
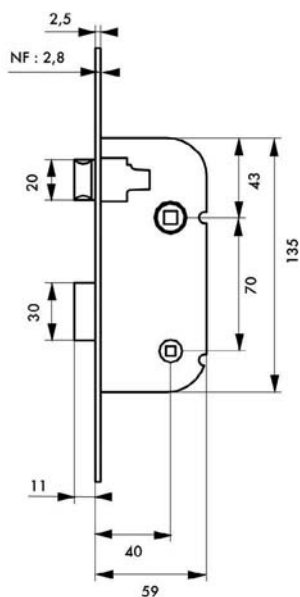

Description/Description/Descripción

Coffre acier embouti. Tête acier. Demi-tour alliage réversible sans démontage du coffre. Pêne acier. Gâche plate acier. Carré 7 mm, entr'axe 70 mm.

Stamped steel case - Steel forend. Reversible alloy latch without removing the case. Steel bolt. Steel flat striker - Square 7 mm.

Caja de acero embutido. Cabeza de acero. Media vuelta de aleación reversible sin desmontar la caja. Pestillo de acero. Cerradero plano de acero - Cuadrado 7 mm.

Finition/Finish/Acabado

Epoxy blanc (V) - Zingué (Z)
White epoxy (V) - Zinc plated (Z)
Epoxi blanco (V) - Cincado (Z)

Versión/Option/Versión

Tête bouts carrés (BC). Tête bouts ronds (BR). Coloris bronze sous conditionnement coque.

Square (BC). Round (BR) ended forend
Cabeza de extremos cuadrados (BC). Cabeza de extremos redondos (BR)

Axe à 40 mm / A CONDAMNATION

PROTECT



GARANTIE



00022161



00022171

Designation	Boite	Colis.	Prix	Sachet	Colis.	Prix	Brochable					Colis.	Prix
							France	Euro 1	Euro 2	Euro 3	Euro 4		
Serrure axe 40mm à condamnation V/BC	00000101	10	-	-	-	-	-	-	-	-	-	-	-
Serrure axe 40mm à condamnation V/BR	00001101	10	-	00901191	10	-	00401191	-	-	-	-	10	-
Serrure axe 40mm à condamnation Z/BC	00010101	10	-	-	-	-	-	-	-	-	-	-	-
Serrure axe 40mm à condamnation Z/BR	00011101	10	-	-	-	-	-	-	-	-	-	-	-

Tarif conditionnement non décollable

Serrure axe 40mm à condamnation V/BC (50 pièces non décollable)	00050191	50	-	-	-	-	-	-	-	-	-	-	-
Serrure axe 40mm à condamnation V/BR (50 pièces non décollable)	00051191	50	-	-	-	-	-	-	-	-	-	-	-

Tarif garniture

Garniture serrure axe 40mm à condamnation VBZ/BR + ensemble ARES	00022161	50	-	-	-	-	-	-	-	-	-	-	-
Garniture serrure axe 40mm à condamnation VBZ/BR + ensemble LETO	00022171	50	-	-	-	-	-	-	-	-	-	-	-

⊗ Non stocké/Non-stored/Productos no estocado - ⊗ Sur stock Europe Zone 1 et Zone 2, nous consulter pour délai d'approvisionnement - ⊗ Epuement/Stock depletion/Agotamiento del stock

Axe à 40 mm / A CONdamnATION PROTECT



GARANTIE

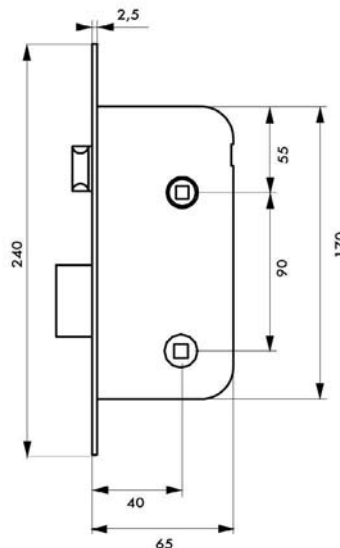

Description/Description/Descripción

Coffre acier embouti. Tête acier bouts ronds. Demi-tour réversible sans démontage du coffre. Pêne alliage zingué. Gâche plate acier. Carré 8 mm, entraxe 90 mm.
Stamped steel case. Steel forend. Reversible latch without removing the case. Zinc plated alloy bolt. Steel flat striker. Square 8 mm.

Caja de acero embutido. Cabeza de acero. Media vuelta reversible sin desmontar la caja. Pestillo de aleación cincada. Cerradero plano de acero. Cuadrado 8 mm.

Finition/Finish/Acabado

Zingué
Zinc coated
Cincado

Designation	Boite	Colis.	Prix	Sachet	Colis.	Prix	Brochable					Colis.	Prix
							France	Euro 1	Euro 2	Euro 3	Euro 4		
Serrure axe 40mm à condamnation Z/BR	-	5	-	-	-	-	-	-	00492252 NS	-	-	-	-

NS Non stocké/Non-stored/Producto no estocado - S Sur stock Europe Zone 1 et Zone 2, nous consulter pour délai d'approvisionnement - E Epuisement/Stock depletion/Agotamiento del stock

Axe à 40 mm / A CONDAMNATION RESIST



Spécifications dimensionnelles
selon la norme NF P 26-409
Essais selon la norme NF
EN 12209
Classification

2 B 4 0 0 F 2 H G 2 0



GARANTIE

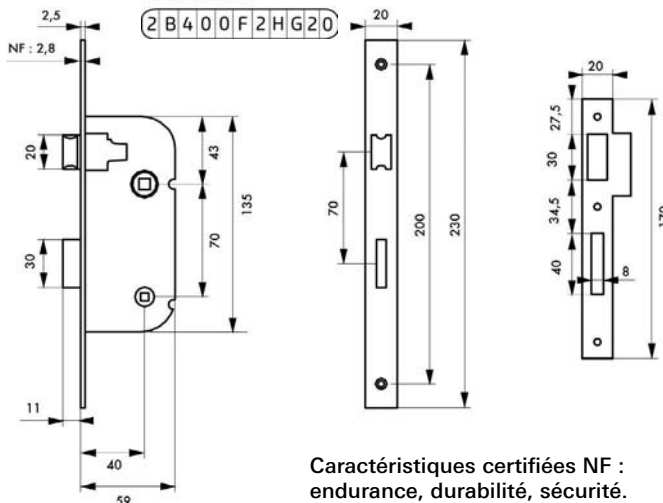

Caractéristiques certifiées NF :
endurance, durabilité, sécurité.

Description/Description/Descripción

Coffre acier embouti. Têtière acier. Demi-tour alliage réversible sans démontage du coffre. Pêne acier. Gâche plate acier. Carré 7 mm, entr'axe 70 mm.

Stamped steel case - Steel forend. Reversible alloy latch without removing the case. Steel bolt. Steel flat striker - Square 7 mm.

Caja de acero embutido. Cabeza de acero. Media vuelta de aleación reversible sin desmontar la caja. Pestillo de acero. Cerradero plano de acero - Cuadrado 7 mm.

Finition/Finish/Acabado

Epoxy noir granité (V) - Zingué (Z)

Black epoxy (V) - Zinc plated (Z)

Epoxi negro granitado (V). Cincado (Z)

Versión/Option/Versión

Têtière bouts carrés (BC) - Têtière bouts ronds (BR)

Square (BC) - Round (BR) ended forend

Cabeza de extremos cuadrados (BC) - Cabeza de extremos redondos (BR)



Designation	Boite	Colis.	Prix	Sachet	Colis.	Prix	Brochable					Colis.	Prix
							France	Euro 1	Euro 2	Euro 3	Euro 4		
Serrure axe 40mm NF à condamnation V/BC	0000501	10	-	-	-	-	00400501	-	-	-	-	10	-
Serrure axe 40mm NF à condamnation V/BR	00001501	10	-	00901501	10	-	00401501	-	-	-	-	10	-
Serrure axe 40mm NF à condamnation V/BR	00061501	10	-	00901501	10	-	00401501	-	-	-	-	10	-
Serrure axe 40mm NF à condamnation Z/BC	00010501	10	-	-	-	-	-	-	-	-	-	-	-
Serrure axe 40mm NF à condamnation Z/BR	00011501	10	-	-	-	-	-	-	-	-	-	-	-

Tarif conditionnement non décolisable

Serrure axe 40mm NF à condamnation V/BC noire (50 pièces non décolisable)	00050501	50	-	-	-	-	-	-	-	-	-	-	-
Serrure axe 40mm NF à condamnation V/BR noire (50 pièces non décolisable)	00051501	50	-	-	-	-	-	-	-	-	-	-	-
Serrure axe 40mm NF à condamnation V/BR blanche (50 pièces non décolisable)	00151501	50	-	-	-	-	-	-	-	-	-	-	-

Non stocké/Non-stored/Producto no estocado - Sur stock Europe Zone 1 et Zone 2, nous consulter pour délai d'approvisionnement - Epuisement/Stock depletion/Agotamiento del stock

Axe à 40 mm / A CONDAMNATION

RESIST



Caractéristiques certifiées NF :
endurance, durabilité, sécurité.



Essais selon la norme NF
EN 12209
Classification

3 S 4 0 0 G 3 H C 3 0



GARANTIE

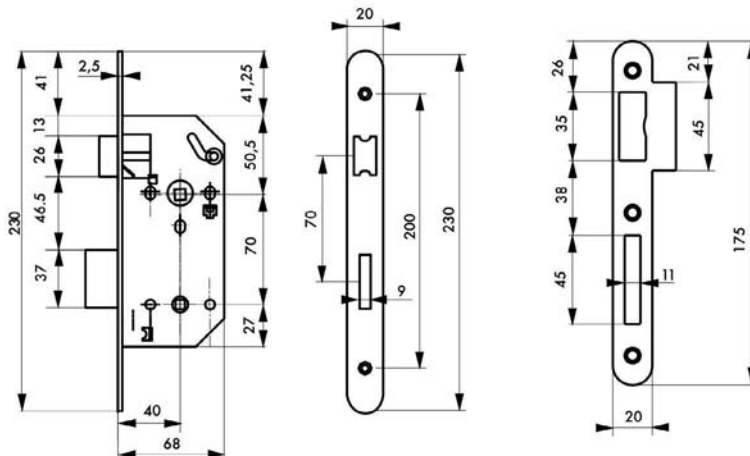

Description/Description/Descripción

Coffre acier embouti. Tête acier bouts ronds. Demi-tour bipente alliage réversible sans démontage du coffre. Pêne acier galvanisé. Gâche plate acier zingué. Carré 7 mm, entr'axe 70 mm.

Stamped steel case. Round ended steel forend. Reversible alloy latch without removing the case. Galvanized steel bolt. Zinc plated steel flat striker. Square 7 mm.

Caja de acero embutido. Cabeza de extremos redondos. Media vuelta de aleación reversible sin desmontar la caja. Pestillo de acero galvanizado. Cerradero plano de acero cincado. Cuadrado 7 mm.

Finition/Finish/Acabado

Coffre galvanisé, tête epoxy noir granité

Case galvanised, forend black epoxy

Caja galvanizado, cabeza epoxy negro

Version/Option/Versión

Tête inox, acier laitonné, acier nickelé. Possibilité carré 8 mm sur demande.

Stainless steel forend, brass plated forend, nickel plated forend. Square 8 mm on request.

Cabeza de acero inoxidable, acero latonado, acero niquelado. Cuadrado 8 mm a petición.

Designation	Boite	Colis.	Prix	Sachet	Colis.	Prix	Brochable					Colis.	Prix
							France	Euro 1	Euro 2	Euro 3	Euro 4		
Serrure MONOMAX NF axe 40mm à condamnation V/BR tête noire	00546810	5	-	-	-	-	-	-	-	-	-	-	-
Serrure MONOMAX NF axe 40mm à condamnation V/BR tête inox	00546811	5	-	-	-	-	-	-	-	-	-	-	-
Serrure MONOMAX NF axe 40mm à condamnation V/BR tête acier laitonné	00546812	5	-	-	-	-	-	-	-	-	-	-	-
Serrure MONOMAX NF axe 40mm à condamnation V/BR tête acier nickelé	00546813	5	-	-	-	-	-	-	-	-	-	-	-

Non stocké/Non-stored/Producto no estocado - Sur stock Europe Zone 1 et Zone 2, nous consulter pour délai d'approvisionnement - E Epusement/Stock depletion/Agotamiento del stock



Designation	Boite	Colis.	Prix	Sachet	Colis.	Prix	Brochable					Colis.	Prix
							France	Euro 1	Euro 2	Euro 3	Euro 4		
Tarif conditionnement non décollable													
Serrure MONOMAX NF axe 40mm à condamnation V/BR sans gâche (25 pièces non décollable)	00046810	25	-	-	-	-	-	-	-	-	-	-	-
Gâche acier pour serrure NORME NF à pêne dormant ½ tour (25 pièces non décollable)	00046102	25	-	-	-	-	-	-	-	-	-	-	-
Serrure MONOMAX NF axe 40mm à condamnation V/BR tête inox sans gâche (25 pièces non décollable)	00046811	25	-	-	-	-	-	-	-	-	-	-	-
Gâche inox pour serrure NORME NF à pêne dormant ½ tour (25 pièces non décollable)	00046103	25	-	-	-	-	-	-	-	-	-	-	-
Tarif garniture													
Garniture MONOMAX NF axe 40mm à condamnation V/BR + ensemble ARES	00022162	50	-	-	-	-	-	-	-	-	-	-	-
Garniture MONOMAX NF axe 40mm à condamnation V/BR + ensemble DEMETER	00022232	50	-	-	-	-	-	-	-	-	-	-	-
Garniture MONOMAX NF axe 40mm à condamnation V/BR + ensemble LETO	00022172	50	-	-	-	-	-	-	-	-	-	-	-
Garniture MONOMAX NF axe 40mm à condamnation V/BR + ensemble VESTA	00022182	50	-	-	-	-	-	-	-	-	-	-	-
Garniture MONOMAX NF axe 40mm à condamnation V/BR + ensemble CHARON	00022202	50	-	-	-	-	-	-	-	-	-	-	-
Garniture MONOMAX NF axe 40mm à condamnation V/BR + ensemble DIONYSOS	00022192	50	-	-	-	-	-	-	-	-	-	-	-
Garniture MONOMAX NF axe 40mm à condamnation V/BR + ensemble DIANE	00022212	50	-	-	-	-	-	-	-	-	-	-	-
Garniture MONOMAX NF axe 40mm à condamnation V/BR + ensemble OURANUS	00022222	50	-	-	-	-	-	-	-	-	-	-	-
Garniture MONOMAX NF axe 40mm à condamnation V/BR + ensemble PELOPE	00022242	50	-	-	-	-	-	-	-	-	-	-	-
Garniture MONOMAX NF axe 40mm à condamnation V/BR + ensemble HERA	00022141	30	-	-	-	-	-	-	-	-	-	-	-
Garniture MONOMAX NF axe 40mm à condamnation V/BR + ensemble THALIA	00022151	30	-	-	-	-	-	-	-	-	-	-	-



Axe à 45 mm / A CONDAMNATION PROTECT

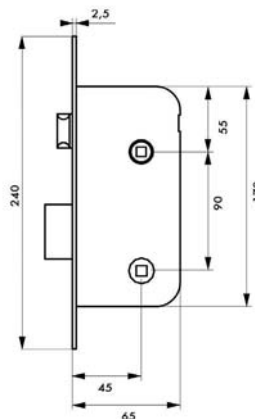

GARANTIE

Description/Description/Descripción

Coffre acier embouti. Tête acier bouts ronds. Demi-tour réversible sans démontage du coffre. Pêne alliage zingué. Gâche plate acier. Carré 8 mm, entraxe 90 mm. *Stamped steel case. Steel forend. Reversible latch without removing the case. Zinc plated alloy bolt. Steel flat striker. Square 8 mm.*

Caja de acero embutido. Cabeza de acero. Media vuelta reversible sin desmontar la caja. Pestillo de aleación cincada. Cerradero plano de acero. Cuadrado 8 mm.

Finition/Finish/Acabado

Noir
Black
Negro

Designation	Boite	Colis.	Prix	Sachet	Colis.	Prix	Brochable					Colis.	Prix
							France	Euro 1	Euro 2	Euro 3	Euro 4		
Serrure axe 45mm à condamnation V/BR	-	-	-	-	-	-	-	-	00492255 NS	-	-	5	-

Axe à 45 mm / A CONDAMNATION PROTECT

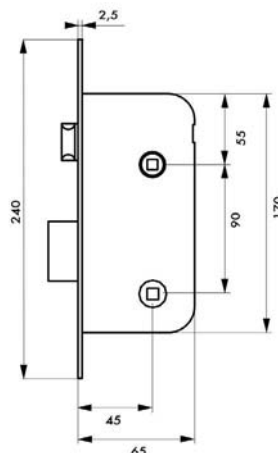

GARANTIE

Description/Description/Descripción

Coffre acier embouti. Tête acier bouts ronds. Demi-tour réversible sans démontage du coffre. Pêne alliage zingué. Gâche plate acier. Carré 8 mm, entr'axe 90 mm. *Stamped steel case. Steel forend. Reversible latch without removing the case. Zinc plated alloy bolt. Steel flat striker. Square 8 mm.*

reversible sin desmontar la caja. Pestillo de aleación cincada. Cerradero plano de acero. Cuadrado 8 mm.

Finition/Finish/Acabado

Zingué
Zinc coated
Cincado

Caja de acero embutido. Cabeza de acero. Media vuelta

Designation	Boite	Colis.	Prix	Sachet	Colis.	Prix	Brochable					Colis.	Prix
							France	Euro 1	Euro 2	Euro 3	Euro 4		
Serrure axe 45mm à condamnation Z/BR	00092258 E NS	1	-	-	-	-	-	-	00492258 NS	-	-	5	-

NS Non stocké/Non-stored/Producto no estocado - E Sur stock Europe Zone 1 et Zone 2, nous consulter pour délai d'approvisionnement - E Epuisement/Stock depletion/Agotamiento del stock

Axe à 50 mm / A CONDAMNATION

ECO



GARANTIE



Coffre épaisseur 10mm

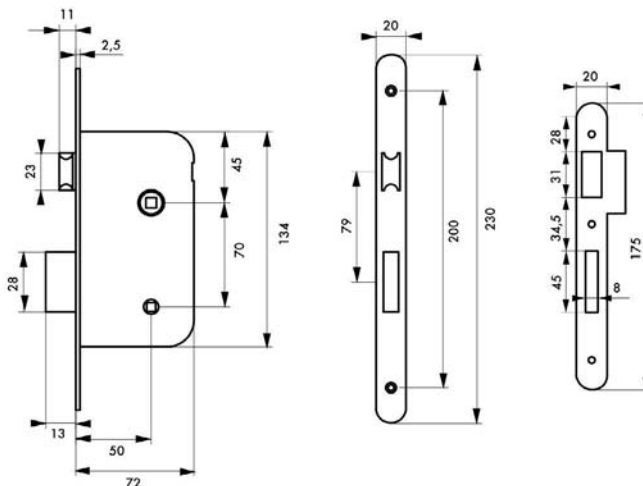

Description/Description/Descripción

Coffre acier embouti épaisseur 10 mm. Tête acier bouts ronds. Demi-tour alliage zingué réversible sans démontage du coffre. Pêne acier zingué. Gâche plate acier. Carré 7 mm, entr'axe 70 mm.

Stamped steel case 10 mm thickness. Steel forend. Reversible zinc plated alloy latch without removing the case. Zinc plated steel bolt. Steel flat striker. Square 7 mm.

Caja de acero embutido 10 mm de espesor. Cabeza de acero. Media vuelta de aleación cincado reversible sin desmontar la caja. Pestillo de acero cincado. Cerradero plano de acero. Cuadrado 7 mm.

Finition/Finish/Acabado
Epoxy blanc (V) Gris métal
White epoxy (V) Metal gray
Epoxi blanco (V) Metal gris

Designation	Boite	Colis.	Prix	Sachet	Colis.	Prix	Brochable					Colis.	Prix
							France	Euro 1	Euro 2	Euro 3	Euro 4		
Serrure axe 50 mm coffre épaisseur 10 mm à condamnation blanche V/BR	-	-	-	00913931	10	-	00413931	-	-	-	-	5	-
Serrure axe 50 mm coffre épaisseur 10 mm à condamnation gris métal/BR	-	-	-	00913934	10	-	-	-	-	-	-	-	-
Serrure axe 50 mm coffre épaisseur 10 mm à condamnation blanche V/BR (50 pièces non décollable)	00013931	50	-	-	-	-	-	-	-	-	-	-	-
Serrure axe 50 mm coffre épaisseur 10 mm à condamnation gris métal/BR (50 pièces non décollable)	00013934	50	-	-	-	-	-	-	-	-	-	-	-

Non stocké/Non-stored/Producto no estocado - Sur stock Europe Zone 1 et Zone 2, nous consulter pour délai d'approvisionnement - Epuement/Stock depletion/Agotamiento del stock

Axe à 50 mm / A CONDAMNATION PROTECT

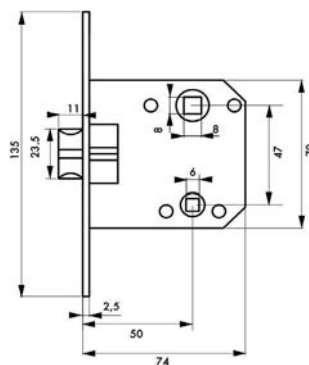

GARANTIE

Description/Description/Descripción

Coffre acier embouti. Tête acier bouts ronds. Demi-tour réversible sans démontage du coffre. Pêne alliage zingué. Gâche plate acier. Carré 8 mm, entr'axe 47 mm. Stamped steel case. Steel forend. Reversible latch without removing the case. Zinc plated alloy bolt. Steel flat striker. Square 8 mm.

Caja de acero embutido. Cabeza de acero. Media vuelta

reversible sin desmontar la caja. Pestillo de aleación cincada. Cerradero plano de acero. Cuadrado 8 mm.

Finition/Finish/Acabado

Zingué
Zinc coated
Cincado

Designation	Boite	Colis.	Prix	Sachet	Colis.	Prix	Brochable					Colis.	Prix
							France	Euro 1	Euro 2	Euro 3	Euro 4		
Serrure axe 50mm à condamnation entraxe 47mm tête laitonée BR	00094367	1	-	-	-	-	-	-	-	00494367	-	5	-

Axe à 50 mm / A CONDAMNATION PROTECT

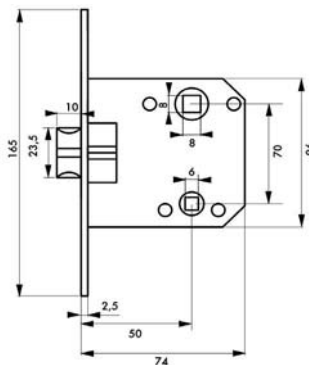

GARANTIE

Description/Description/Descripción

Coffre acier embouti. Tête acier bouts ronds. Demi-tour réversible sans démontage du coffre. Pêne alliage zingué. Gâche plate acier. Carré 8 mm, entr'axe 70 mm. Stamped steel case. Steel forend. Reversible latch without removing the case. Zinc plated alloy bolt. Steel flat striker. Square 8 mm.

Caja de acero embutido. Cabeza de acero. Media vuelta

reversible sin desmontar la caja. Pestillo de aleación cincada. Cerradero plano de acero. Cuadrado 8 mm.

Finition/Finish/Acabado

Zingué
Zinc coated
Cincado

Designation	Boite	Colis.	Prix	Sachet	Colis.	Prix	Brochable					Colis.	Prix
							France	Euro 1	Euro 2	Euro 3	Euro 4		
Serrure axe 50mm à condamnation entraxe 70mm tête laitonée BR	00094599	1	-	-	-	-	-	-	-	00494599	-	5	-

Axe à 50 mm / A CONDAMANTION ECO

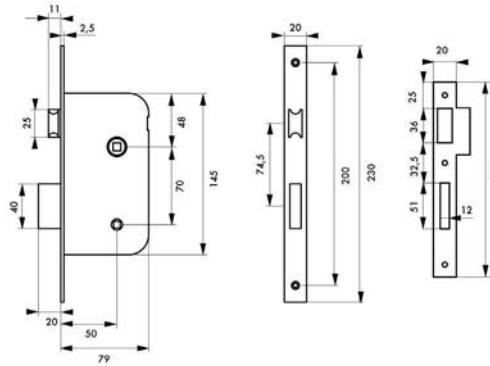

GARANTIE

Description/Description/Descripción

Coffre acier embouti épaisseur 11 mm. Tête acier bouts ronds. Demi-tour réversible sans démontage du coffre. Pêne alliage zingué bichromaté. Gâche plate acier. Carré 7 mm, entraxe 70 mm

Stamped steel case thickness 11 mm. Steel forend. Reversible latch without removing the case. Bichromated zinc plated alloy bolt. Steel flat striker - Square 7 mm.

Caja de acero embutido espesor 11 mm.

Cabeza de acero. Media vuelta reversible sin desmontar la caja. Pestillo de aleación cincada bicromatada. Cerradero plano de acero - Cuadrado 7mm

Finition/Finish/Acabado

Epoxy noir granité (V)
Black epoxy (V)
Epoxi negro granitado (V)

Designation	Boite	Colis.	Prix	Sachet	Colis.	Prix	Brochable					Colis.	Prix
							France	Euro 1	Euro 2	Euro 3	Euro 4		
Serrure axe 50mm à condamnation V/BR/Z	-	-	-	00901201	10	-	00401201	-	-	-	-	10	-

Axe à 50 mm / MAGNETIQUE, A CONDAMNATION PROTECT

CONFORT D'UTILISATION : - silence de fonctionnement - pas de pêne en saillie

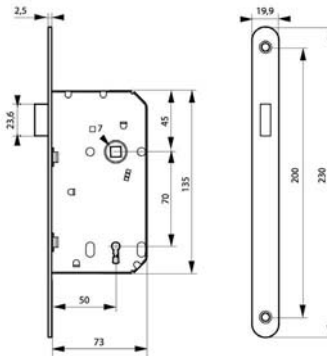

GARANTIE

Description/Description/Descripción

Coffre acier embouti. Tête acier bouts ronds. Système magnétique à pêne rétractable. Gâche plate acier. Carré 7 mm, entr'axe 70 mm.

Pressed steel safe. Steel rounded head forend. Magnetic system with retractable bolt. Steel flat strike. Square 7 mm.

Caja de acero embutido. Cabeza de acero extremos

redondos. Sistema magnético de pestillo retraíble. Gacheta plana de acero. Cuadrado 7 mm.

Finition/Finish/Acabado

Fer satiné
Satin iron
Hierro satinado

Designation	Boite	Colis.	Prix	Sachet	Colis.	Prix	Brochable					Colis.	Prix
							France	Euro 1	Euro 2	Euro 3	Euro 4		
Serrure axe 50mm magnétique à condamnation /BR	-	-	-	00901551	10	-	00401551	-	-	-	-	5	-

Non stocké/Non-stored/Producto no estocado - Sur stock Europe Zone 1 et Zone 2, nous consulter pour délai d'approvisionnement - Epuement/Stock depletion/Agotamiento del stock

Axe à 50 mm / A CONDAMNATION

PROTECT



GARANTIE



Tête amovible et nombreuses finitions disponibles

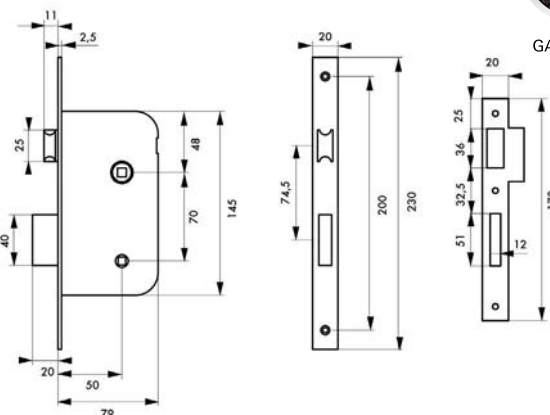

Description/Description/Descripción

Coffre acier embouti. Tête acier. Demi-tour réversible sans démontage du coffre. Pêne alliage zingué. Gâche plate acier. Carré 7 mm, entr'axe 70 mm.

Stamped steel case. Steel forend. Reversible latch without removing the case. Zinc plated alloy bolt. Steel flat striker - Square 7 mm.

Caja de acero embutido. Cabeza de acero. Media vuelta reversible sin desmontar la caja. Pestillo de aleación cincada. Cerradero plano de acero - Cuadrado 7 mm.

Finition/Finish/Acabado

Epoxy noir (V) - Zingué (Z)

Black epoxy (V) - Zinc plated (Z)

Epoxi negro (V) - Cincado (Z)

Version/Option/Versión

Tête bouts carrés (BC). Tête bouts ronds (BR). Tête acier nickelé. Tête laiton brossé. Tête laiton poli verni. Tête laiton poli nickelé.

Square (BC). Round (BR) ended forend. Nickel plated steel forend. Brushed brass forend. Varnish polished brass forend. Polish nickel plated brass forend.

Cabeza de extremos cuadrados (BC). Cabeza de extremos redondos (BR). Cabeza de acero niquelado. Cabeza de latón cepillado. Cabeza de latón pulido barnizado. Cabeza de latón pulido niquelado.

Designation	Boite	Colis.	Prix	Sachet	Colis.	Prix	Brochable					Colis.	Prix
							France	Euro 1	Euro 2	Euro 3	Euro 4		
Serrure axe 50mm à condamnation V/BC/Z	00000201	5	-	-	-	-	-	-	-	-	-	-	-
Serrure axe 50mm à condamnation V/BR/Z	00001201	5	-	-	-	-	-	-	-	-	-	-	-
Serrure axe 50mm à condamnation tête acier nickelé V/BR/L	00019321	5	-	-	-	-	-	-	-	-	-	-	-
Serrure axe 50mm à condamnation Z/BC/Z	00010201	5	-	-	-	-	-	-	-	-	-	-	-
Serrure axe 50mm à condamnation Z/BR/Z	00011201	5	-	-	-	-	-	-	-	-	-	-	-
Serrure axe 50mm à condamnation tête laiton brossé V/BR/L	00019501	5	-	-	-	-	-	-	-	-	-	-	-
Serrure axe 50mm à condamnation tête laiton poli verni V/BR/L	00019221	5	-	-	-	-	-	-	-	-	-	-	-
Serrure axe 50mm à condamnation tête laiton poli nickelé V/BR/L	00019211	5	-	-	-	-	-	-	-	-	-	-	-
Serrure axe 50mm à condamnation tête inox V/BR/L	00019241 ^{NS}	5	-	-	-	-	-	-	-	-	-	-	-

Axe à 50 mm / A CONdamnATION PROTECT

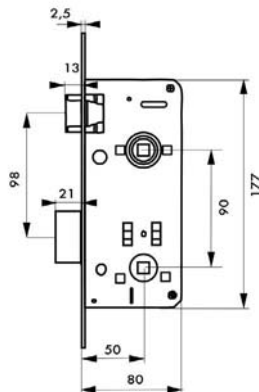

GARANTIE

Description/Description/Descripción

Coffre acier embouti. Tête acier bouts ronds. Demi-tour réversible sans démontage du coffre. Pêne alliage zingué. Gâche plate acier. Carré 8 mm, entraxe 90 mm. Stamped steel case. Steel forend. Reversible latch without removing the case. Zinc plated alloy bolt. Steel flat striker. Square 8 mm.

Caja de acero embutido. Cabeza de acero. Media vuelta reversible sin desmontar la caja. Pestillo de aleación cincada. Cerradero plano de acero. Cuadrado 8 mm.

Finition/Finish/Acabado

Zingué
Zinc coated
Cincado

Designation	Boite	Colis.	Prix	Sachet	Colis.	Prix	Brochable					Colis.	Prix
							France	Euro 1	Euro 2	Euro 3	Euro 4		
Serrure axe 50mm à condamnation entraxe 90mm Z/BR/Z	-	-	-	-	-	-	-	00493308 NSI	00492308 NS	-	-	1	-

Axe à 50 mm / A CONdamnATION PROTECT

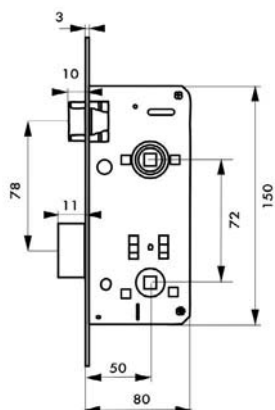

GARANTIE

Description/Description/Descripción

Coffre acier embouti. Tête acier bouts ronds. Demi-tour réversible sans démontage du coffre. Pêne alliage zingué. Gâche plate acier. Carré 8 mm, entraxe 72 mm. Stamped steel case. Steel forend. Reversible latch without removing the case. Zinc plated alloy bolt. Steel flat striker. Square 8 mm.

Caja de acero embutido. Cabeza de acero. Media vuelta reversible sin desmontar la caja. Pestillo de aleación cincada. Cerradero plano de acero. Cuadrado 8 mm.

Finition/Finish/Acabado

Zingué
Zinc coated
Cincado

Designation	Boite	Colis.	Prix	Sachet	Colis.	Prix	Brochable					Colis.	Prix
							France	Euro 1	Euro 2	Euro 3	Euro 4		
Serrure axe 50mm à condamnation entraxe 72mm Z/BR/Z	00093664 NSI	1	-	-	-	-	-	00493664 NSI	-	-	-	1	-

NS Non stocké/Non-stored/Producto no estocado - SI Sur stock Europe Zone 1 et Zone 2, nous consulter pour délai d'approvisionnement - E Epuisement/Stock depletion/Agotamiento del stock

Axe à 50 mm / A CONDAMNATION

RESIST

Caractéristiques certifiées NF :
endurance, durabilité, sécurité.



GARANTIE



Essais selon la norme NF

EN 12209

Classification

3 S 4 0 0 G 3 H G 3 0

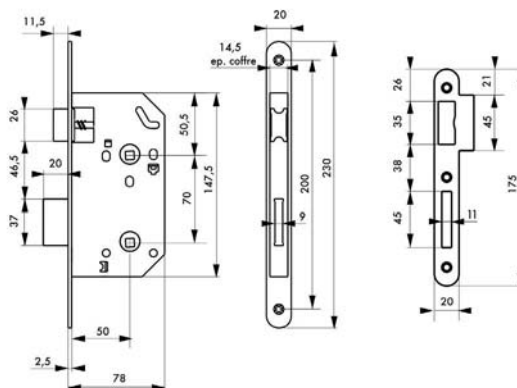

Description/Description/Descripción

Coffre acier embouti. Têtière acier bouts ronds. Demi-tour bipente alliage réversible sans démontage du coffre. Pêne acier galvanisé. Gâche plate acier zingué. Mécanisme à 2 tours. Carré 7 mm, entr'axe 70 mm.
Stamped steel case. Round ended steel forend. Reversible alloy latch without removing the case. Galvanized steel bolt. Zinc plated steel flat striker. Square 7 mm.
Caja de acero embutido. Cabeza de extremos redondos. Media vuelta de aleación reversible sin desmontar la caja. Pestillo de acero galvanizado. Cerradero plano de acero cincado. Cuadrado 7 mm.

Finition/Finish/Acabado

Coffre galvanisé, têtière epoxy noir granité
Case galvanised, forend black epoxy
Caja galvanizado, cabeza epoxy negro
Version/Option/Versión
Têtière inox, acier laitonné, acier nickelé. Possibilité carré 8 mm sur demande.
Stainless steel forend, brass plated forend, nickel plated forend. Square 8 mm on request.
Cabeza de acero inoxidable, acero latonado, acero niquelado. Cuadrado 8 mm a petición.

Designation	Boite	Colis.	Prix	Sachet	Colis.	Prix	Brochable					Colis.	Prix
							France	Euro 1	Euro 2	Euro 3	Euro 4		
Serrure MONOMAX NF axe 50mm à condamnation tèteière noire BR	00556810	5	-	00956810	20	-	00456810	-	-	-	-	5	-
Serrure MONOMAX NF axe 50mm à condamnation tèteière noire BC	00556910	5	-	-	-	-	-	-	-	-	-	-	-
Serrure MONOMAX NF axe 50mm à condamnation tèteière inox BR	00556811	5	-	-	-	-	00456811	-	-	-	-	5	-
Serrure MONOMAX NF axe 50mm à condamnation tèteière acier laitonné BR	00556812	5	-	-	-	-	-	-	-	-	-	-	-
Serrure MONOMAX NF axe 50mm à condamnation tèteière acier nickelé BR	00556813	5	-	-	-	-	-	-	-	-	-	-	-

Tarif conditionnement non décolisable

Serrure MONOMAX NF axe 50mm à condamnation tèteière noire BR sans gâche (25 pièces non décolisable)	00056810	25	-	-	-	-	-	-	-	-	-	-	-
Gâche acier pour serrure NORME NF à pêne dormant ½ tour (25 pièces non décolisable)	00046102	25	-	-	-	-	-	-	-	-	-	-	-
Serrure MONOMAX NF axe 50mm à condamnation tèteière inox BR sans gâche (25 pièces non décolisable)	00056811	25	-	-	-	-	-	-	-	-	-	-	-
Gâche inox pour serrure NORME NF à pêne dormant ½ tour (25 pièces non décolisable)	00046103	25	-	-	-	-	-	-	-	-	-	-	-

Non stocké/Non-stored/Producto no estocado - Sur stock Europe Zone 1 et Zone 2, nous consulter pour délai d'approvisionnement - E Epusement/Stock depletion/Agotamiento del stock

Axe à 50 mm / A CONDAMNATION RESIST



Caractéristiques certifiées NF :
endurance, durabilité, sécurité.

Spécifications dimensionnelles
selon la norme NF P 26-414

Essais selon la norme NF

EN 12209:2003+AC:2005

Classification

3 5 4 1 0 G 3 H G 3 0

1/2 HOURS
Apte à équiper un
bloc-porte réesistant
au feu



GARANTIE

Homologation par le
laboratoire EFECTIS

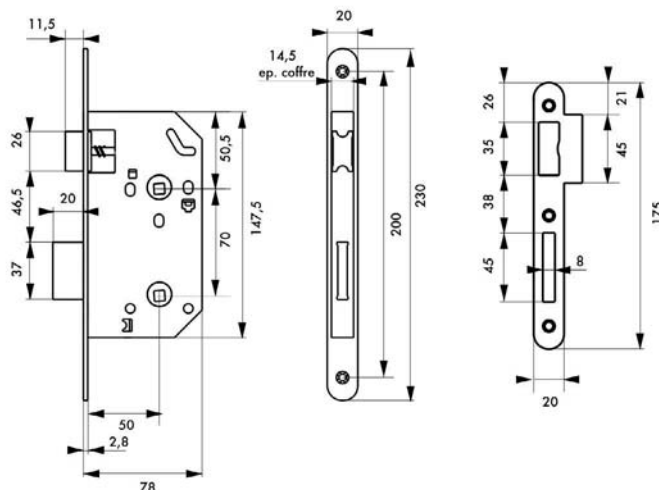

Description/Description/Descripción

Coffre acier embouti galvanisé. Têtière acier bouts ronds.
Demi-tour bipente laiton réversible sans démontage
du coffre. Pêne acier zingué - Gâche plate acier zingué.
Carré 7 mm, entr'axe 70 mm.

*Stamped steel case. Steel forend. Reversible brass latch
without removing the case. Steel flat striker. Steel zinc
plated bolt. Square 7 mm.*

Caja de acero embutido. Cabeza de acero. Media vuelta
de latón reversible sin desmontar la caja. Pestillo de aleación
cincada Cerradero plano de acero. Cuadrado 7 mm.

Finition/Finish/Acabado

Coffre galvanisé, tèteière noir granité
Case galvanised, forend black epoxy
Caja galvanizado, cabeza epoxi negro

Version/Option/Versión

Tèteière inox, acier laitonné, acier nickelé. Possibilité carré
8 mm sur demande.

*Stainless steel forend, brass plated forend, nickel plated
forend. Square 8 mm on request.*

Cabeza de acero inoxidable, acero latonado, acero nique-
lado. Cuadrado 8 mm a petición.

Designation	Boite	Colis.	Prix	Sachet	Colis.	Prix	Brochable					Colis.	Prix
							France	Euro 1	Euro 2	Euro 3	Euro 4		
Serrure UNIMAX CE NF QC axe 50mm tèteière noire V/BR	00015201	5	-	-	-	-	-	-	-	-	-	-	-
Serrure UNIMAX CE NF QC axe 50mm tèteière laitonée V/BR	00015231	5	-	-	-	-	-	-	-	-	-	-	-
Serrure UNIMAX CE NF QC axe 50mm tèteière nickelée V/BR	00015221	5	-	-	-	-	-	-	-	-	-	-	-
Serrure UNIMAX CE NF QC axe 50mm tèteière inox V/BR	00015241	5	-	-	-	-	-	-	-	-	-	-	-

Non stocké/Non-stored/Producto no estocado - Sur stock Europe Zone 1 et Zone 2, nous consulter pour délai d'approvisionnement - Epuisement/Stock depletion/Agotamiento del stock

Axe à 55 mm / A CONDAMNATION «ALSACE»

ECO



GARANTIE

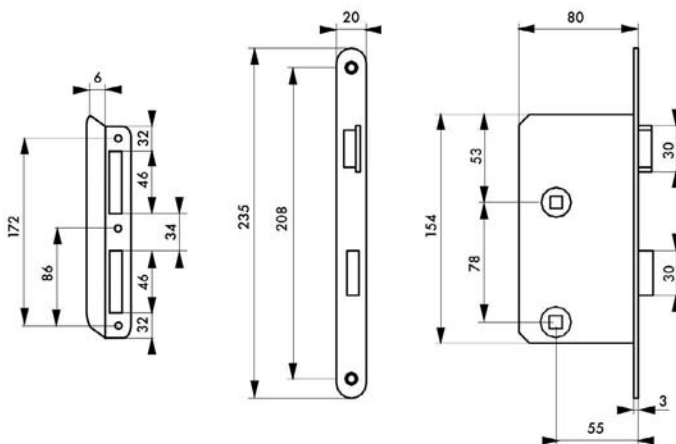

Description/Description/Descripción

Coffre acier cambré. Têtière acier bouts ronds. Demi-tour polyamide. Fouillot polyamide. Pêne polyamide. Mécanisme à 1 tour. Carré 8 mm. Gâche équerre acier. (Demi-tour et fouillot zamak : réf. 055001, 055011).

Cambered steel case. Round ended steel forend. Polyamid latch, Polyamid follower. Polyamid bolt. One latch mechanism. Square 8 mm. Angle steel striker. (Zamak latch and follower : ref. 055001, 055011)

Caja de acero curvado. Cabeza de acero de extremos redondos. Media vuelta de poliamida. Nuez de poliamida. Pestillo de poliamida. Mecanismo de 1 vuelta con reposición de la media vuelta con la llave. Cuadrado 8 mm. Cerradero escuadra de acero. (Media vuelta y nuez zamak : ref. 055001, 055011)

Finition/Finish/Acabado

Têtière vernie - Coffre zingué
Varnished forend - Zinc plated case
Cabeza barnizada - Caja cincada

Version/Option/Versión

Droite ou gauche - Pêne dormant 1/2 tour, 1 clé
Right or left hand - With 1 key
Derecha o izquierda Pestillo durmiente de media vuelta, 1 llave

Designation	Boite	Colis.	Prix	Sachet	Colis.	Prix	Brochable					Colis.	Prix
							France	Euro 1	Euro 2	Euro 3	Euro 4		
Serrure axe 50mm à condamnation entraxe 78 mm droite	00055001	1	-	00955001	20	-	00455001	00493225 E NS	00492225 E NS	00494225	-	5	-
Serrure axe 50mm à condamnation entraxe 78 mm gauche	00055011	1	-	00955011	20	-	00455011	00493226 E NS	00492226 E NS	00494226	-	5	-
Serrure axe 50mm à condamnation entraxe 72 mm droite	00055901	1	-	-	-	-	00455901	-	-	-	-	5	-
Serrure axe 50mm à condamnation entraxe 72 mm gauche	00055911	1	-	-	-	-	00455911	-	-	-	-	5	-

NS Non stocké/Non-stored/Producto no estocado - E Sur stock Europe Zone 1 et Zone 2, nous consulter pour délai d'approvisionnement - E Epuisement/Stock depletion/Agotamiento del stock

Axe à 60 mm / A CONDAMNATION

PROTECT



GARANTIE

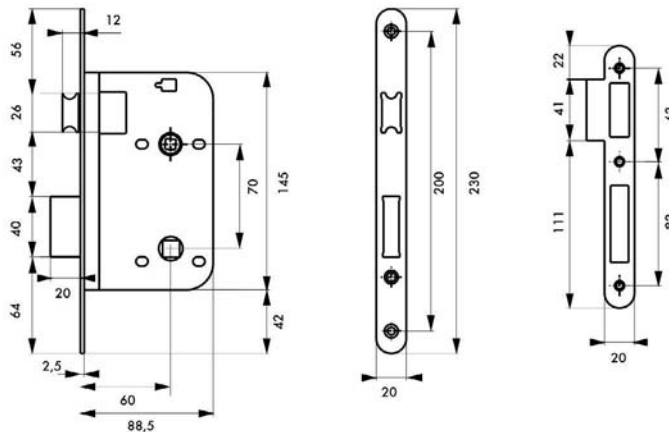

Description/Description/Descripción

Coffre acier embouti. Têtière laiton. 1/2 tour laiton réversible sans démontage du coffre. Pêne laiton. Carré 7 mm. Gâche plate selon finition.

Stamped steel case. Brass forend. Reversible brass latch without removing the case. Brass bolt. Square 7 mm. Flat striker.

Caja de acero embutido. Cabeza de latón. Media vuelta de latón reversible sin desmontar la caja Pestillo de latón. Cuadrado 7 mm. Cerradero plano.

Finition/Finish/Acabado

Epoxy noir. Têtière laiton brossé. Têtière laiton poli verni. Têtière nickelé. Têtière noire.

Black epoxy. Brushsed brass forend - Black forend. Polished brass forend - Nickel forend.

Epoxi negro. Cabeza de latón cepillado. Cabeza de latón pulido barnizado. Cabeza niquelado - Cabeza negro

Version/Option/Versión

Bec de cane. A cylindre profilé.

Without key. With profile cylinder.

Resbalón. De cilindro perfilado.

Designation	Boite	Colis.	Prix	Sachet	Colis.	Prix	Brochable					Colis.	Prix
							France	Euro 1	Euro 2	Euro 3	Euro 4		
Serrure axe 60mm à condamnation têtère laiton brossé V/BR/L	00009301	5	-	-	-	-	-	-	-	-	-	-	-
Serrure axe 60mm à condamnation têtère laiton poli verni V/BR/L	00019301	5	-	-	-	-	-	-	-	-	-	-	-
Serrure axe 60mm à condamnation têtère nickelé V/BR/L	00019391	5	-	-	-	-	-	-	-	-	-	-	-
Serrure axe 60mm à condamnation têtère noire V/BR/L	00019351	5	-	-	-	-	-	-	-	-	-	-	-

Non stocké/Non-stored/Producto no estocado - Sur stock Europe Zone 1 et Zone 2, nous consulter pour délai d'approvisionnement - Epuisement/Stock depletion/Agotamiento del stock

Axe à 70 mm / A CONDAMNATION

PROTECT



GARANTIE

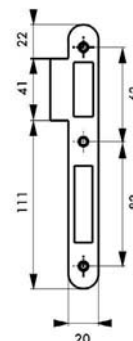
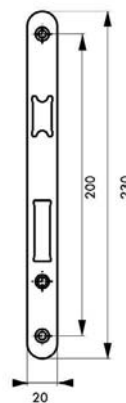
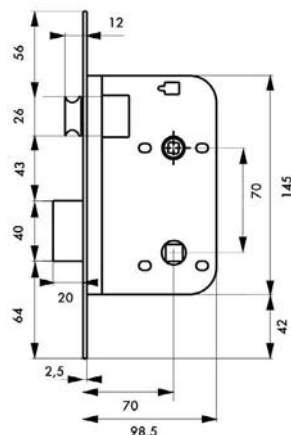

Description/Description/Descripción

Coffre acier embouti. Têtière laiton. 1/2 tour laiton réversible sans démontage du coffre. Pêne laiton. Carré 7 mm. Gâche plate selon finition.
Stamped steel case. Brass forend. Reversible brass latch without removing the case. Brass bolt. Square 7 mm. Flat striker.

Caja de acero embutido. Cabeza de latón. Media vuelta de latón reversible sin desmontar la caja Pestillo de latón. Cuadrado 7 mm. Cerradero plano.

Finition/Finish/Acabado

Epoxy noir. Têtière laiton brossé. Têtière laiton poli verni. Têtière nickelé. Têtière noire.
Black epoxy. Brushsed brass forend - Black forend. Polished brass forend - Nickel forend

Epoxi negro. Cabeza de latón cepillado. Cabeza de latón pulido barnizado. Cabeza niquelada - Cabeza negro

Version/Option/Versión

Bec de cane. A cylindre profilé.
Without key. With profile cylinder.
 Resbalón. De cilindro perfilado.

Designation	Boite	Colis.	Prix	Sachet	Colis.	Prix	Brochable					Colis.	Prix
							France	Euro 1	Euro 2	Euro 3	Euro 4		
Serrure axe 70mm à condamnation tèteière laiton brossé V/BR/L	00007201	5	-	-	-	-	-	-	-	-	-	-	-
Serrure axe 70mm à condamnation tèteière laiton poli verni V/BR/L	00007291	5	-	-	-	-	-	-	-	-	-	-	-
Serrure axe 70mm à condamnation tèteière nickelé V/BR/L	00017291	5	-	-	-	-	-	-	-	-	-	-	-
Serrure axe 70mm à condamnation tèteière noire V/BR/L	00017251	5	-	-	-	-	-	-	-	-	-	-	-

⚠ Non stocké/Non-stored/Producto no estocado - 📦 Sur stock Europe Zone 1 et Zone 2, nous consulter pour délai d'approvisionnement - 📦 Epuisement/Stock depletion/Agotamiento del stock

Axe à 80 mm / A CONDAMNATION

PROTECT



GARANTIE

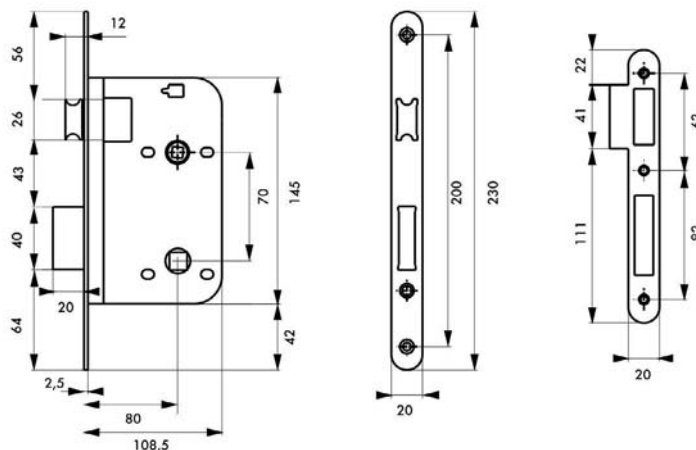

Description/Description/Descripción

Coffre acier embouti. Têtière laiton. 1/2 tour laiton réversible sans démontage du coffre. Pêne laiton. Rappel du 1/2 tour par la clé. Carré 7 mm, entr'axe 70 mm. Gâche plate selon finition.

Stamped steel case. Brass forend. Reversible brass latch without removing the case. Brass bolt. Square 7 mm. Flat striker.

Caja de acero embutido. Cabeza de latón. Media vuelta de latón reversible sin desmontar la caja. Pestillo de latón. Cuadrado 7 mm. Cerradero plano.

Finition/Finish/Acabado

Epoxy noir. Têtière laiton poli verni. Têtière nickelé. Têtière noire.

Black epoxy. Polished brass forend - Nickel forend. Black forend.

Epoxi negro. Cabeza de latón pulido barnizado. Cabeza niquelado - Cabeza negro.

Version/Option/Versión

Bec de cane. A condamnation. A cylindre profilé.

Without key. With profile cylinder.

Resbalón. De cilindro perfilado.

Utilisation/Use/Utilización

Porte intérieure et extérieure.

For inside and entrance doors.

Para puertas de interior y exterior.

Designation	Boite	Colis.	Prix	Sachet	Colis.	Prix	Brochable					Colis.	Prix
							France	Euro 1	Euro 2	Euro 3	Euro 4		
Serrure axe 80mm à condamnation têtère laiton poli verni V/BR/L	00080291	5	-	-	-	-	-	-	-	-	-	-	-
Serrure axe 80mm à condamnation têtère nickelé V/BR/L	00081291	5	-	-	-	-	-	-	-	-	-	-	-
Serrure axe 80mm à condamnation têtère noire V/BR/L	00081251	5	-	-	-	-	-	-	-	-	-	-	-

Non stocké/Non-stored/Producto no estocado - Sur stock Europe Zone 1 et Zone 2, nous consulter pour délai d'approvisionnement - Epuisement/Stock depletion/Agotamiento del stock

Axe à 40 mm / PÊNE DORMANT 1/2 TOUR

ECO



GARANTIE



X 1



Description/Description/Descripción

Coffre acier embouti. Tête acier. Demi-tour alliage réversible sans démontage du coffre. Pêne acier. Gâche plate acier. Mécanisme à 1 tour. Carré 7 mm, entr'axe 70 mm. 1 clé. 6 variétés

Stamped steel case. Steel forend. Reversible alloy latch without removing the case. Steel bolt. Steel flat striker. One deadbolt throw. Square 7 mm. 1 key - 6 different keys.

Caja de acero embutido. Cabeza de acero. Media vuelta de aleación reversible sin desmontar la caja. Pestillo de acero. Cerrador plano de acero. Mecanismo de 1 vuelta. Cuadrado 7 mm. 1 llave - 6 perfiles de llave

Finition/Finish/Acabado

Epoxy blanc (V) - Zingué blanc (ZB)

White epoxy (V) - White zinc plated (ZB)

Epoxi blanco (V) - Cincado blanco (ZB)

Version/Option/Versión

Tête bouts carrés (BC) - Tête bouts ronds (BR). 2 clés avec mécanisme à 2 tours.

Square (BC) - Round (BR) ended forend. 2 keys with two deadbolt throw.

Cabeza de extremos cuadrados (BC) - Cabeza de extremos redondos (BR). 2 llaves con mecanismo de 2 vueltas.

Utilisation/Use/Utilización

Porte isoplane < 40 kg, (NON GARANTIE EN CAS DE CONTRE BEQUILLAGE)

Door < 40 kg

Puerta < 40 kg

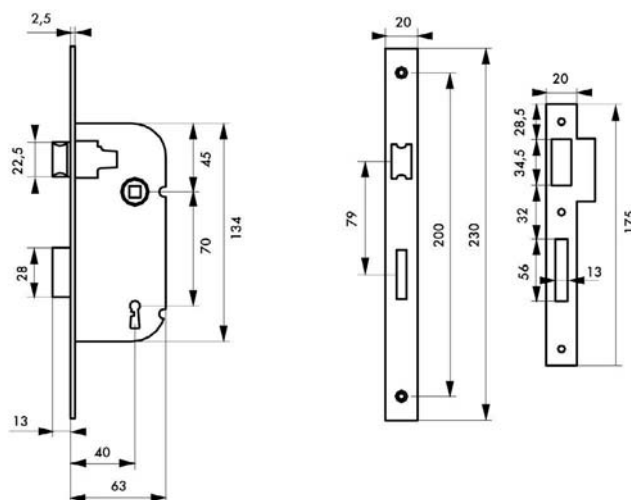

Designation	Boite	Colis.	Prix	Sachet	Colis.	Prix	Brochable					Colis.	Prix
							France	Euro 1	Euro 2	Euro 3	Euro 4		
Serrure axe 40mm PDT 1/2 tour V/BC 1 clé	-	-	-	-	-	-	00400102	-	-	-	-	10	-
Serrure axe 40mm pêne dormant 1/2 tour V/BR 1 clé	-	-	-	00901102	30	-	00401102	-	-	-	-	10	-
Serrure axe 40mm pêne dormant 1/2 tour Z/BR 1 clé	-	-	-	00911102	30	-	00411102	-	-	-	-	10	-
Serrure axe 40mm pêne dormant 1/2 tour V/BC 2 clés	-	-	-	-	-	-	00400105	-	-	-	-	10	-
Serrure axe 40mm pêne dormant 1/2 tour V/BR 2 clés	-	-	-	00901105	30	-	00401105	-	-	-	-	10	-

Tarif conditionnement non décollable

Serrure axe 40mm pêne dormant 1/2 tour V/BR 1 clé sans gâche - droite (50 pièces non décollable)	00081112	50	-	-	-	-	-	-	-	-	-	-	-
Serrure axe 40mm pêne dormant 1/2 tour V/BR 1 clé sans gâche - gauche (50 pièces non décollable)	00081122	50	-	-	-	-	-	-	-	-	-	-	-
Gâche type Eco (50 pièces non décollable)	00081003	50	-	-	-	-	-	-	-	-	-	-	-

Tarif garniture

Garniture serrure Eco+ axe 40mm pêne dormant 1/2 tour V/BR 1 clé + ensemble ARES	00022163	50	-	00922163	50	-	-	-	-	-	-	-	-
Garniture serrure Eco+ axe 40mm pêne dormant 1/2 tour V/BR 1 clé + ensemble LETO	00022173	50	-	00922173	50	-	-	-	-	-	-	-	-
Garniture serrure Eco+ axe 40mm pêne dormant 1/2 tour V/BR 1 clé + ensemble VESTA	00022183	50	-	00922183	50	-	-	-	-	-	-	-	-
Garniture serrure Eco+ axe 40mm pêne dormant 1/2 tour V/BR 1 clé + ensemble DIONYSOS	00022193	50	-	00922193	50	-	-	-	-	-	-	-	-

☒ Non stocké/Non-stored/Productos no estocado - ☑ Sur stock Europe Zone 1 et Zone 2, nous consulter pour délai d'approvisionnement - ☒ Epuement/Stock depletion/Agotamiento del stock

Axe à 40 mm / PÊNE DORMANT 1/2 TOUR

ECO

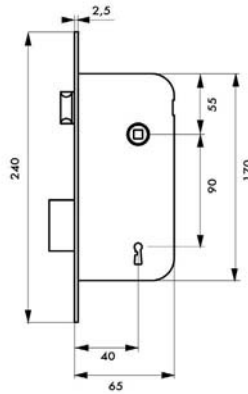

GARANTIE



X 2

Description/Description/Descripción

Coffre acier embouti. Têtière acier bouts ronds. Demi-tour réversible sans démontage du coffre. Pêne alliage zingué. Gâche plate acier. Carré 8 mm, entr'axe 90 mm. 2 clés. Sans rappel du 1/2 tour par la clé.

Stamped steel case. Steel forend. Reversible latch without removing the case. Zinc plated alloy bolt. Steel flat striker. Square 8 mm. 2 keys. Without drawback of the latch by the key.

Caja de acero embutido. Cabeza de acero. Media vuelta reversible sin desmontar la caja. Pestillo de aleación cincada. Cerradero plano de acero. Cuadrado 8 mm. 2 llaves. No reposición de la media vuelta con llave.

Finition/Finish/Acabado

Noir
Black
Negro

Designation	Boite	Colis.	Prix	Sachet	Colis.	Prix	Brochable					Colis.	Prix
							France	Euro 1	Euro 2	Euro 3	Euro 4		
Serrure axe 40mm pêne dormant 1/2 tour V/BR 2 clés	-	-	-	-	-	-	-	-	00492250 NS	-	-	5	-

Axe à 40 mm / PÊNE DORMANT 1/2 TOUR

ECO

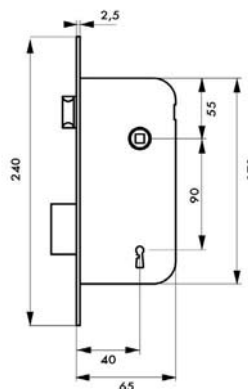

GARANTIE



X 2

Description/Description/Descripción

Coffre acier embouti. Têtière acier bouts ronds. Demi-tour réversible sans démontage du coffre. Pêne alliage zingué. Gâche plate acier. Carré 8 mm, entr'axe 90 mm. 2 clés. Sans rappel du 1/2 tour par la clé.

Stamped steel case. Steel forend. Reversible latch without removing the case. Zinc plated alloy bolt. Steel flat striker. Square 8 mm. 2 keys. Without drawback of the latch by the key.

Caja de acero embutido. Cabeza de acero. Media vuelta reversible sin desmontar la caja. Pestillo de aleación cincada. Cerradero plano de acero. Cuadrado 8 mm. 2 llaves. No reposición de la media vuelta con llave.

Finition/Finish/Acabado

Noir
Black
Negro

Designation	Boite	Colis.	Prix	Sachet	Colis.	Prix	Brochable					Colis.	Prix
							France	Euro 1	Euro 2	Euro 3	Euro 4		
Serrure axe 40mm pêne dormant 1/2 tour Z/BR 2 clés	-	-	-	-	-	-	-	-	00492253 NS	-	-	5	-

NS Non stocké/Non-stored/Producto no estocado - S Sur stock Europe Zone 1 et Zone 2, nous consulter pour délai d'approvisionnement - E Epuisement/Stock depletion/Agotamiento del stock

Axe à 40 mm / PÊNE DORMANT 1/2 TOUR

ECO



GARANTIE

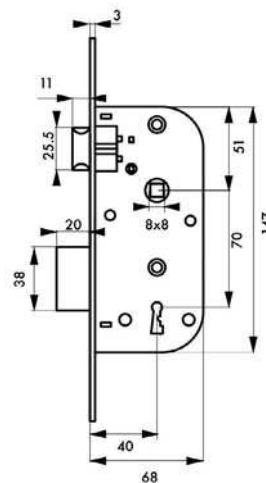

Description/Description/Descripción

Coffre acier embouti. Tête acier bouts carrés. Demitour réversible sans démontage du coffre. Pêne alliage zingué bichromaté. Gâche plate acier. Carré 8 mm, entraxe 70 mm. 2 clés (094525 - 1 clé). Sans rappel du 1/2 tour par la clé.

Stamped steel case. Steel forend. Reversible latch without removing the case. Zinc plated alloy bolt. Steel striker.

Square 8 mm. 2 keys (094525 - 1 key). Without drawback of the latch by the key.

Caja de acero embutido. Cabeza de acero. Media vuelta reversible sin desmontar la caja. Pestillo de aleación cincada. Cerradero plano de acero. Cuadrado 8 mm. 2 llaves (094525 - 1 llave). No reposición de la media vuelta con llave.

Finition/Finish/Acabado

Zingué Têteière laitonée. Têteière nickelée.

Zinc coated. Brass plated forend. Nickel forend.

Cincado. Cabeza de latónado. Cabeza níquelado

Designation	Boite	Colis.	Prix	Sachet	Colis.	Prix	Brochable					Colis.	Prix
							France	Euro 1	Euro 2	Euro 3	Euro 4		
Serrure axe 40mm pêne dormant 1/2 tour têteière laitonée BC 1 clé	00094394	1	-	-	-	-	-	-	-	00494394	-	5	-
Serrure axe 40mm pêne dormant 1/2 tour têteière nickelée BC 1 clé	00094525	1	-	-	-	-	-	-	-	00494525	-	10	-

Non stocké/Non-stored/Producto no estocado - Sur stock Europe Zone 1 et Zone 2, nous consulter pour délai d'approvisionnement - Epuisement/Stock depletion/Agotamiento del stock

Axe à 40 mm / PÊNE DORMANT 1/2 TOUR ECO

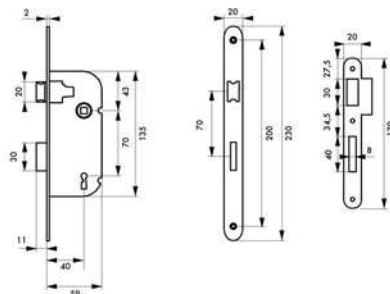

GARANTIE

Description/Description/Descripción

Coff re acier embouti. Têtière acier bouts ronds ép.2mm. Demi-tour nylon réversible sans démontage du coff re. Pêne dormant acier. Gâche plate acier. Mécanisme à 1 tour. Carré nylon 7 mm, entraxe 70 mm. Sans rappel du 1/2 tour par la clé.

Stamped steel case. Steel forend. Reversible nylon latch without removing the case. Steel bolt. Steel at striker. One deadbolt throw. Nylon square 7 mm. Without drawback of the latch by the key.

Caja de acero embutido. Cabeza de acero de 2mm de espesor. Media vueltade nylon reversible sin desmon-

tar la caja. Pestillo de acero. Cerradero plano de acero. Mecanismo de 1 vuelta. Cuadrado de nylon 7 mm. No reposicide la media vuelta con llave.

Finition/Finish/Acabado

Epoxy blanc.

White epoxy.

Epoxi blanco.

Versión/Option/Versión

2 clés.

2 keys.

2 llaves.

Designation	Boite	Colis.	Prix	Sachet	Colis.	Prix	Brochable					Colis.	Prix
							France	Euro 1	Euro 2	Euro 3	Euro 4		
Tarif conditionnement non décollable													
Serrure Eco axe à 40mm pêne dormant 1/2 tour V/ BR 1 clé (50 pièces non décollable)	00053192	50	-	-	-	-	-	-	-	-	-	-	-
Serrure Eco axe à 40mm pêne dormant 1/2 tour V/ BR 2 clés (50 pièces non décollable)	00053195	50	-	-	-	-	-	-	-	-	-	-	-

Axe à 40 mm / MAGNETIQUE, PÊNE DORMANT 1/2 TOUR PROTECT



CONFORT D'UTILISATION : silence de fonctionnement - pas de pêne en saillie

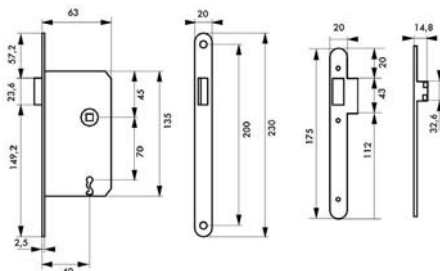

GARANTIE

Description/Description/Descripción

Coffre acier embouti. Têtière acier bouts ronds. Système magnétique à pêne rétractable. Gâche plate acier. Carré 7 mm, entr'axe 70 mm. 1 clé.

Pressed steel safe. Steel rounded head forend. Magnetic system with retractable bolt. Steel flat strike. Square 7 mm. 1 key.

Caja de acero embutido. Cabeza de acero extremos

redondos. Sistema magnético de pestillo retraíble. Gacheta plana de acero. Cuadrado 7 mm. 1 llave.

Finition/Finish/Acabado

Fer satiné

Satin iron

Hierro satinado



X 1

Designation	Boite	Colis.	Prix	Sachet	Colis.	Prix	Brochable					Colis.	Prix
							France	Euro 1	Euro 2	Euro 3	Euro 4		
Serrure axe 40mm magnétique pêne dormant 1/2 tour 1 clé /BR	00001152	1	-	00901152	10	-	00401152	-	-	-	-	5	-

Non stocké/Non-stored/Producto no estocado - Sur stock Europe Zone 1 et Zone 2, nous consulter pour délai d'approvisionnement - E Epuisement/Stock depletion/Agotamiento del stock

Axe à 40 mm / PÊNE DORMANT 1/2 TOUR

PROTECT



GARANTIE



X 1

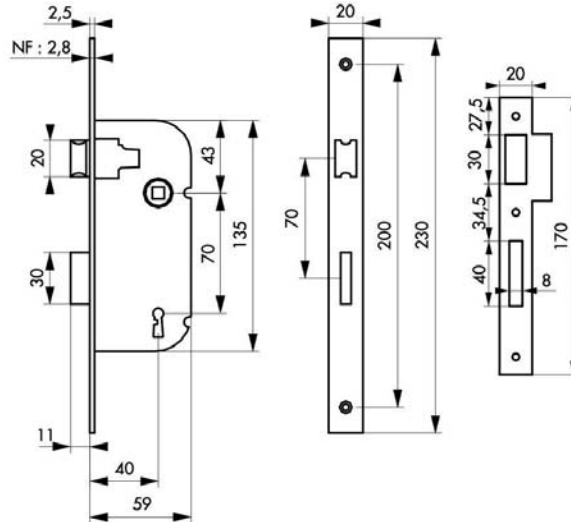

Description/Description/Descripción

Coffre acier embouti. Têtière inox. Demi-tour alliage réversible sans démontage du coffre. Pêne acier. Gâche plate inox. Mécanisme à 1 tour. Carré 7 mm, entr'axe 70 mm. 1 clé. 6 variures.

Stamped steel case. Stainless steel forend. Reversible alloy latch without removing the case. Steel bolt. Stainless steel flat striker. One deadbolt throw. Square 7 mm. 1 key - 6 different keys.

Caja de acero embutido. Cabeza de acero inoxidable. Media vuelta de aleación reversible sin desmontar la caja. Pestillo de acero. Cerrador plano de acero inoxidable. Mecanismo de 1 vuelta. Cuadrado 7 mm. 1 llave - 6 perfiles de llave.

Finition/Finish/Acabado

Zingué
Zinc plated
Cincado



Designation	Boite	Colis.	Prix	Sachet	Colis.	Prix	Brochable					Colis.	Prix
							France	Euro 1	Euro 2	Euro 3	Euro 4		
Serrure axe 40mm pêne dormant 1/2 tour tête inox BR 1 clé - avec gâche	-	-	-	00982112	10	-	00482112	-	-	-	-	5	-
Tarif conditionnement non décollable													
Serrure axe 40mm pêne dormant 1/2 tour tête inox BR 1 clé -sans gâche (50 pièces non décollable)	00082112	50	-	-	-	-	-	-	-	-	-	-	-
Gâche inox (50 pièces non décollable)	00082001	50	-	-	-	-	-	-	-	-	-	-	-

Ⓜ Non stocké/Non-stored/Producto no estocado - Ⓜ Sur stock Europe Zone 1 et Zone 2, nous consulter pour délai d'approvisionnement - Ⓜ Epuisement/Stock depletion/Agotamiento del stock

Axe à 40 mm / PÊNE DORMANT 1/2 TOUR

PROTECT



GARANTIE



X 1

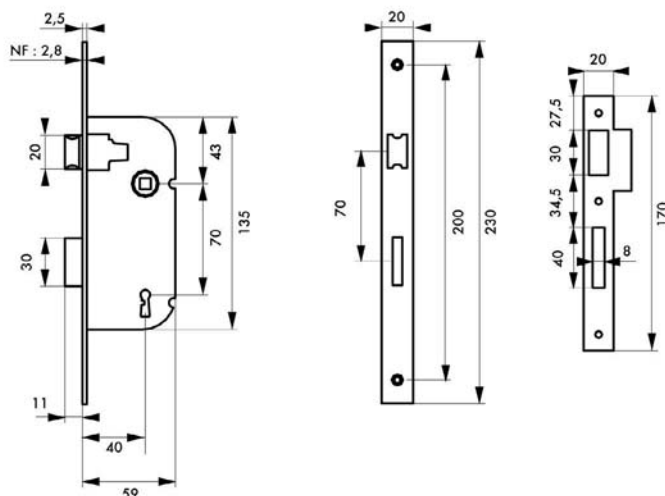

Description/Description/Descripción

Coffre acier embouté. Tête acier. Demi-tour alliage réversible sans démontage du coffre. Pêne acier. Gâche plate acier. Mécanisme à 1 ou 2 tours (avec 2 clés). Carré 7 mm, entr'axe 70 mm. 1 clé. 6 variures.

Stamped steel case. Steel forend. Reversible alloy latch without removing the case. Steel bolt. Steel flat striker. One or two deadbolt throw. Square 7 mm. 1 key - 6 different keys.

Caja de acero embutido. Cabeza de acero. Media vuelta de aleación reversible sin desmontar la caja. Pestillo de acero. Cerrador plano de acero. Mecanismo de 1 ó 2 vueltas (con 2 llaves). Cuadrado 7 mm. 1 llave - 6 perfiles de llave.

Finition/Finish/Acabado

Epoxy blanc (V) - Zingué (Z)
White epoxy (V) - Zinc plated (Z)
Epoxi blanco (V) - Cincado (Z)

Version/Option/Versión

Tête à bouts carrés (BC). Tête à bouts ronds (BR). Coloris bronze sous conditionnement coque.
Square (BC). Round (BR) ended forend
Cabeza de extremos cuadrados (BC). Cabeza de extremos redondos (BR)

Axe à 40 mm / PÊNE DORMANT 1/2 TOUR

PROTECT



Designation	Boite	Colis.	Prix	Sachet	Colis.	Prix	Brochable					Colis.	Prix
							France	Euro 1	Euro 2	Euro 3	Euro 4		
Serrure axe 40mm pêne dormant 1/2 tour 1 tour V/ BC 1 clé	00000102	10	-	-	-	-	-	-	-	-	-	-	-
Serrure axe 40mm pêne dormant 1/2 tour 1 tour V/ BR 1 clé	00001102	10	-	00901192	10	-	00401192	-	-	-	-	10	-
Serrure axe 40mm pêne dormant 1/2 tour 1 tour Z/ BC 1 clé	00010102	10	-	-	-	-	-	-	-	-	-	-	-
Serrure axe 40mm pêne dormant 1/2 tour 1 tour Z/ BR 1 clé	00011102	10	-	-	-	-	-	-	-	-	-	-	-
Serrure axe 40mm pêne dormant 1/2 tour 2 tours V/ BC 2 clés	00000105	10	-	-	-	-	-	-	-	-	-	-	-
Serrure axe 40mm pêne dormant 1/2 tour 2 tours V/ BR 2 clés	00001105	10	-	-	-	-	00401195	-	-	-	-	10	-
Serrure axe 40mm pêne dormant 1/2 tour 2 tours Z/ BC 2 clés	00010105	10	-	-	-	-	-	-	-	-	-	-	-
Serrure axe 40mm pêne dormant 1/2 tour 2 tours Z/ BR 2 clés	00011105	10	-	-	-	-	-	-	-	-	-	-	-

Tarif conditionnement non décolisable

Serrure axe 40mm pêne dormant 1/2 tour 1 tour V/ BC 1 clé (50 pièces non décolisable)	00050192 NS	50	-	-	-	-	-	-	-	-	-	-	-
Serrure axe 40mm pêne dormant 1/2 tour 1 tour V/ BR 1 clé (50 pièces non décolisable)	00051192	50	-	-	-	-	-	-	-	-	-	-	-
Serrure axe 40mm pêne dormant 1/2 tour 2 tours V/ BC 2 clés (50 pièces non décolisable)	00050195 NS	50	-	-	-	-	-	-	-	-	-	-	-
Serrure axe 40mm pêne dormant 1/2 tour 2 tours V/ BR 2 clés (50 pièces non décolisable)	00051195	50	-	-	-	-	-	-	-	-	-	-	-

Tarif garniture

Garniture axe 40mm pêne dormant 1/2 tour VBZ/BR 2 clés + ensemble ARES	00022164	50	-	-	-	-	-	-	-	-	-	-	-
Garniture axe 40mm pêne dormant 1/2 tour VBZ/BR 2 clés + ensemble LETO	00022174	50	-	-	-	-	-	-	-	-	-	-	-

NS Non stocké/Non-stored/Producto no estocado - Sur stock Europe Zone 1 et Zone 2, nous consulter pour délai d'approvisionnement - E Epuisement/Stock depletion/Agotamiento del stock



Axe à 40 mm / PÊNE DORMANT 1/2 TOUR RESIST



Spécifications dimensionnelles
selon la norme NF P 26-409
Essais selon la norme NF

EN 12209
Classification

2B400F2HD20



GARANTIE



X 1

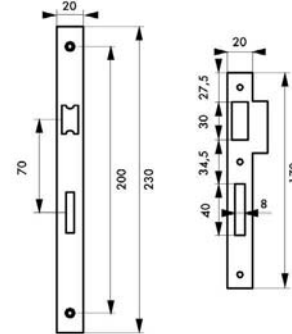
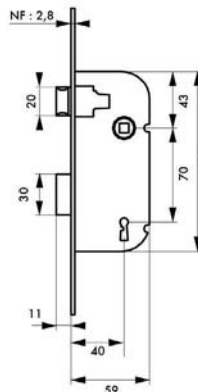

Caractéristiques certifiées NF :
endurance, durabilité, sécurité.

Description/Description/Descripción

Coffre acier embouti. Têtière acier. Demi-tour alliage réversible sans démontage du coffre. Pêne acier. Gâche plate acier. Mécanisme à 1 tour. Carré 7 mm, entr'axe 70 mm. 1 clé - 6 variures.

Stamped steel case. Steel forend. Reversible alloy latch without removing the case. Steel bolt. Steel flat striker. One or two deadbolt throw. Square 7 mm. 1 key - 6 different keys. n° P26409 NF, patented model.

Caja de acero embutido. Cabeza de acero. Media vuelta de aleación reversible sin desmontar la caja. Pestillo de acero. Cerrador plano de acero. Mecanismo de 1 ó 2

vueltas (con 2 llaves). Cuadrado 7 mm. 1 llave - 6 perfiles de llave. Modelo admitido en la norma NF, n° P26409.

Finition/Finish/Acabado

Epoxy noir granité (V). Zingué (Z).

Black epoxy (V) - Zinc plated (Z)

Epoxi negro granitado (V). Cincado (Z)

Version/Option/Versión

Têtière bouts carrés (BC) - Têtière bouts ronds (BR).

Square (BC) - Round (BR) ended forend.

Cabeza de extremos cuadrados (BC) - Cabeza de extremos redondos (BR).

Designation	Boite	Colis.	Prix	Sachet	Colis.	Prix	Brochable					Colis.	Prix
							France	Euro 1	Euro 2	Euro 3	Euro 4		
Serrure axe 40mm NF pêne dormant 1/2 tour V/BC 1clé	0000502	10	-	-	-	-	00400502	-	-	-	-	10	-
Serrure axe 40mm NF pêne dormant 1/2 tour V/BR 1 clé	00001502	10	-	00901502	10	-	00401502	-	-	-	-	10	-
Serrure axe 40mm NF pêne dormant 1/2 tour V/BR 1 clé	00061502	10	-	00941502	10	-	00441502	-	-	-	-	10	-
Serrure axe 40mm NF pêne dormant 1/2 tour Z/BC 1clé	00010502	10	-	-	-	-	-	-	-	-	-	-	-
Serrure axe 40mm NF pêne dormant 1/2 tour Z/BR 1 clé	00011502	10	-	-	-	-	-	-	-	-	-	-	-

Tarif conditionnement non décollable

Serrure axe 40mm NF pêne dormant 1/2 tour V/BC noire - 1 clé (50 pièces non décollable)	00050502	50	-	-	-	-	-	-	-	-	-	-	-
Serrure axe 40mm NF pêne dormant 1/2 tour V/BR noire - 1 clé (50 pièces non décollable)	00051502	50	-	-	-	-	-	-	-	-	-	-	-
Serrure axe 40mm NF pêne dormant 1/2 tour V/BR blanche - 1 clé (50 pièces non décollable)	00151502	50	-	-	-	-	-	-	-	-	-	-	-

⚠ Non stocké/Non-stored/Producto no estocado - 📦 Sur stock Europe Zone 1 et Zone 2, nous consulter pour délai d'approvisionnement - 📦 Epuisement/Stock depletion/Agotamiento del stock

Axe à 40 mm / PÊNE DORMANT 1/2 TOUR

RESIST



Caractéristiques certifiées NF :
endurance, durabilité, sécurité



niveau 2

Essais selon la norme NF

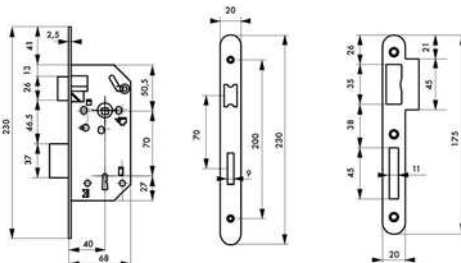

EN 12209

Classification

3S400G3HF30



GARANTIE



X 1

Description/Description/Descripción

Coffre acier embouti. Têtière acier bouts ronds. Demi-tour bipente alliage réversible sans démontage du coffre. Pêne acier galvanisé. Gâche plate acier zingué. Mécanisme à 2 tours. Carré 7 mm, entr'axe 70 mm. 1 clé. 4 Variures.

Stamped steel case. Round ended steel forend. Reversible alloy latch without removing the case. Galvanised steel bolt. Zinc plated steel flat striker. Double deadbolt throw. Draw back of the latch by key. Square 7 mm.

Caja de acero embutido. Cabeza de extremos redondos. Media vuelta de aleación reversible sin desmontar la caja. Pestillo de acero galvanizado. Cerradero plano de acero cincado. Mecanismo de 2 vueltas. Reposición de la media vuelta con la llave. Cuadrado 7 mm.

Finition/Finish/Acabado

Coffre galvanisé, têtière epoxy noir granité

Case galvanised, forend black epoxy
Caja galvanizado, cabeza epoxy negro

Versión/Option/Versión

Têtière inox, acier laitonné, acier nickelé. Possibilité carré 8 mm sur demande.

Stainless steel forend, brass plated forend, nickel plated forend. Square 8 mm on request.

Cabeza de acero inoxidable, acero latonado, acero niquelado. Cuadrado 8 mm a petición.

Designation	Boite	Colis.	Prix	Sachet	Colis.	Prix	Brochable					Colis.	Prix
							France	Euro 1	Euro 2	Euro 3	Euro 4		
Serrure MONOMAX NF axe 40mm pêne dormant 1/2 tour têtère noire BR 1 clé	00546820	5	-	-	-	-	-	-	-	-	-	-	-
Serrure MONOMAX NF axe 40mm pêne dormant 1/2 tour têtère noire BC 1 clé	00546820	5	-	-	-	-	-	-	-	-	-	-	-
Serrure MONOMAX NF axe 40mm pêne dormant 1/2 tour têtère inox BR 1 clé	00546821	5	-	-	-	-	-	-	-	-	-	-	-
Serrure MONOMAX NF axe 40mm pêne dormant 1/2 tour têtère acier laitonné BR 1 clé	00546822	5	-	-	-	-	-	-	-	-	-	-	-
Serrure MONOMAX NF axe 40mm pêne dormant 1/2 tour têtère acier nickelé BR 1 clé	00546823	5	-	-	-	-	-	-	-	-	-	-	-

Tarif conditionnement non décolisable

Serrure MONOMAX NF axe 40mm pêne dormant 1/2 tour têtère noire BR 1 clé - sans gâche (25 pièces non décolisable)	00046820	25	-	-	-	-	-	-	-	-	-	-	-
Gâche acier pour serrure NORME NF à pêne dormant 1/2 tour (25 pièces non décolisable)	00046102	25	-	-	-	-	-	-	-	-	-	-	-
Serrure MONOMAX NF axe 40mm pêne dormant 1/2 tour têtère inox BR 1 clé - sans gâche (25 pièces non décolisable)	00046821	25	-	-	-	-	-	-	-	-	-	-	-
Gâche inox pour serrure NORME NF à pêne dormant 1/2 tour (25 pièces non décolisable)	00046103	25	-	-	-	-	-	-	-	-	-	-	-

Tarif garniture

Garniture serrure MONOMAX NF axe 50mm pêne dormant 1/2 tour têtère noire BR + ensemble HERA	00022142	30	-	-	-	-	-	-	-	-	-	-	-
Garniture serrure MONOMAX NF axe 50mm pêne dormant 1/2 tour têtère noire BR + ensemble THALIA	00022152	30	-	-	-	-	-	-	-	-	-	-	-

Non stocké/Non-stored/Producto no estocado - Sur stock Europe Zone 1 et Zone 2, nous consulter pour délai d'approvisionnement - Epuement/Stock depletion/Agotamiento del stock

Axe à 43 mm / PÊNE DORMANT 1/2 TOUR PROTECT

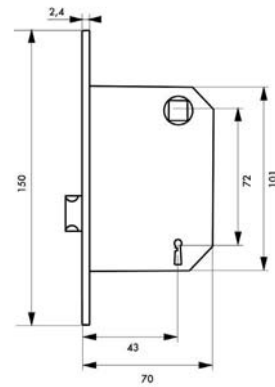

GARANTIE



X 1

Description/Description/Descripción

Coffre acier embouti. Têtière acier bouts ronds. Demi-tour réversible sans démontage du coffre. Pêne alliage zingué. Gâche plate acier. Carré 8 mm, entr'axe 72 mm. 1 clé. Sans rappel du 1/2 tour par la clé.

Stamped steel case. Steel forend. Reversible latch without removing the case. Zinc plated alloy bolt. Steel flat striker. Square 8 mm. 1 key. Without drawback of the latch by the key.

Caja de acero embutido. Cabeza de acero. Media vuelta reversible sin desmontar la caja. Pestillo de aleación cincada. Cerradero plano de acero. Cuadrado 8 mm. 1 llave. No reposición de la media vuelta con llave.

Finition/Finish/Acabado

Blanc, marron
White, brown
Blanco, marón

Designation	Boite	Colis.	Prix	Sachet	Colis.	Prix	Brochable				Colis.	Prix	
							France	Euro 1	Euro 2	Euro 3			Euro 4
Serrure axe 43mm pêne dormant 1/2 tour V/BR blanche 1 clé	-	-	-	-	-	-	-	-	00492261 NS	-	-	5	-
Serrure axe 43mm pêne dormant 1/2 tour V/BR marron 1 clé	-	-	-	-	-	-	-	-	00492362 NS	-	-	5	-

Axe à 45 mm / PÊNE DORMANT 1/2 TOUR ECO

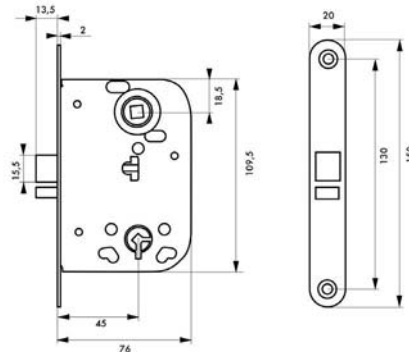

GARANTIE



X 1

Description/Description/Descripción

Coffre acier embouti. Têtière acier bouts ronds. Demi tour réversible sans démontage du coffre. Pêne alliage zingué. Gâche plate acier. Mécanisme à 1 tour. Carré 8 mm, entraxe 72 mm. 1 clé. 12 variures. Sans rappel du 1/2 tour par la clé.

Stamped steel case. Steel forend. Reversible latch without removing the case. Zinc plated alloy bolt. Steel flat striker. One deadbolt throw. Square 8 mm. 1 key - 12 different keys. Without drawback of the latch by the key.

Caja de acero embutido. Cabeza de acero. Media vuelta reversible sin desmontar la caja. Pestillo de aleación cincada. Cerradero plano de acero. Mecanismo de 1 vuelta. Cuadrado 8 mm. 1 llave - 12 perfiles de llave. No reposición de la media vuelta con llave.

Finition/Finish/Acabado

Zingué Têtière laitonée.
Zinc coated. Brass plated forend.
Cincado. Cabeza de latónado.

Designation	Boite	Colis.	Prix	Sachet	Colis.	Prix	Brochable				Colis.	Prix	
							France	Euro 1	Euro 2	Euro 3			Euro 4
Serrure axe 45mm pêne dormant 1/2 tour têtère laitonée BR 1 clé	00093666 NS	1	-	-	-	-	-	00493666 NS	-	-	-	5	-

NS Non stocké/Non-stored/Producto no estocado - ☐ Sur stock Europe Zone 1 et Zone 2, nous consulter pour délai d'approvisionnement - E Epuisement/Stock depletion/Agotamiento del stock

Axe à 45 mm / PÊNE DORMANT 1/2 TOUR ECO



GARANTIE



X 2

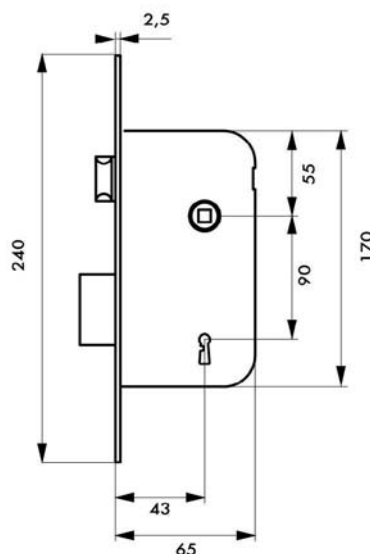

Description/Description/Descripción

Coffre acier embouti. Têtière acier bouts ronds. Demi-tour réversible sans démontage du coffre. Pêne alliage zingué. Gâche plate acier. Carré 8 mm, entr'axe 90 mm. 2 clés. Sans rappel du 1/2 tour par la clé.

Stamped steel case. Steel forend. Reversible latch without removing the case. Zinc plated alloy bolt. Steel flat striker. Square 8 mm. 2 keys. Without drawback of the latch by the key.

Caja de acero embutido. Cabeza de acero. Media vuelta reversible sin desmontar la caja. Pestillo de aleación cincada. Cerradero plano de acero. Cuadrado 8 mm. 2 llave. No reposición de la media vuelta con llave.

Finition/Finish/Acabado

Noir, zingué, marron
Black, zinc coated, brown
Negro, cincado, marón



Designation	Boite	Colis.	Prix	Sachet	Colis.	Prix	Brochable					Colis.	Prix
							France	Euro 1	Euro 2	Euro 3	Euro 4		
Serrure axe 45mm pêne dormant 1/2 tour entraxe 90mm noire BR 1 clé	-	-	-	-	-	-	-	-	00492256 NS	-	-	5	-
Serrure axe 45mm pêne dormant 1/2 tour entraxe 90mm zinguée BR 1 clé	-	-	-	-	-	-	-	-	00492259 NS	-	-	5	-
Serrure axe 45mm pêne dormant 1/2 tour entraxe 90mm marron BR 1 clé	-	-	-	-	-	-	-	-	00492440 NS	-	-	5	-

NS Non stocké/Non-stored/Producto no estocado - Sur stock Europe Zone 1 et Zone 2, nous consulter pour délai d'approvisionnement - E Epuisement/Stock depletion/Agotamiento del stock

Axe à 45 mm / PÊNE DORMANT 1/2 TOUR ECO

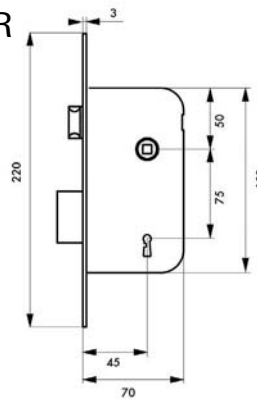

GARANTIE



X 2

Description/Description/Descripción

Coffre acier embouti. Têtière acier bouts ronds. Demi-tour réversible sans démontage du coffre. Pêne alliage zingué. Gâche plate acier. Carré 8 mm, entr'axe 75 mm. 2 clés. Sans rappel du 1/2 tour par la clé.

Stamped steel case. Steel forend. Reversible latch without removing the case. Zinc plated alloy bolt. Steel flat striker. Square 8 mm. 2 keys. Without drawback of the latch by the key.

Caja de acero embutido. Cabeza de acero. Media vuelta reversible sin desmontar la caja. Pestillo de aleación cincada. Cerradero plano de acero. Cuadrado 8 mm. 2 llave. No reposición de la media vuelta con llave.

Finition/Finish/Acabado

Zingué Têtière laitonnée.
Cincado.Cabeza de latónado.

Designation	Boite	Colis.	Prix	Sachet	Colis.	Prix	Brochable					Colis.	Prix
							France	Euro 1	Euro 2	Euro 3	Euro 4		
Serrure axe 45mm pêne dormant 1/2 tour entraxe 75mm têtière laitonnée BR 2 clés	00094342	1	-	-	-	-	-	-	-	00494342	-	5	-

Axe à 45 mm / PÊNE DORMANT 1/2 TOUR ECO

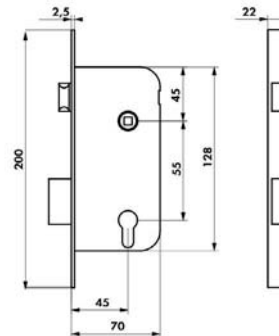

GARANTIE



X 2

Description/Description/Descripción

Coffre acier embouti épaisseur 14,5 mm. Têtière acier bouts ronds. Demi-tour réversible sans démontage du coffre. Pêne alliage zingué. Gâche plate acier. Carré 8 mm, entr'axe 55 mm. 2 clés. Sans rappel du 1/2 tour par la clé.

Stamped steel case thickness 14,5mm. Steel forend. Reversible latch without removing the case. Zinc plated alloy bolt. Steel flat striker. Square 8 mm. 2 keys. Without drawback of the latch by the key.

Caja de acero embutido espesor 14,5 mm. Cabeza de acero. Media vuelta reversible sin desmontar la caja. Pestillo de aleación cincada. Cerradero plano de acero. Cuadrado 8 mm. 2 llaves. No reposición de la media vuelta con llave.

Finition/Finish/Acabado

Zingué
Cincado

Designation	Boite	Colis.	Prix	Sachet	Colis.	Prix	Brochable					Colis.	Prix
							France	Euro 1	Euro 2	Euro 3	Euro 4		
Serrure axe 45mm pêne dormant 1/2 tour entraxe 55mm têtière noire BR 2 clés	-	-	-	-	-	-	-	-	00492439	-	-	5	-

NS Non stocké/Non-stored/Producto no estocado - S Sur stock Europe Zone 1 et Zone 2, nous consulter pour délai d'approvisionnement - E Epuisement/Stock depletion/Agotamiento del stock

Axe à 50 mm / PÈNE DORMANT 1/2 TOUR

ECO



GARANTIE



X 1



Coffre épaisseur 10mm

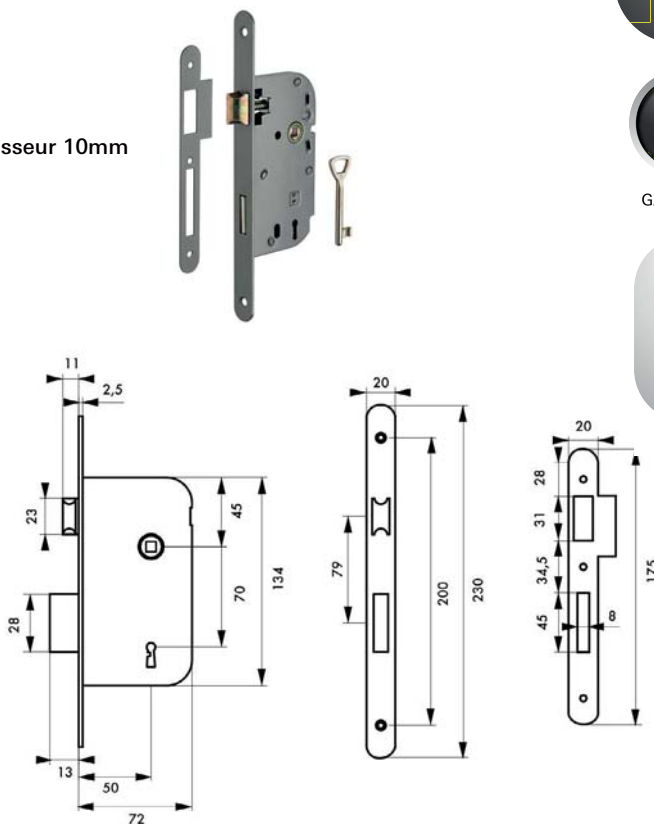

Description/Description/Descripción

Coffre acier embouti épaisseur 10 mm. Tête acier. Demi-tour alliage zingué réversible sans démontage du coffre. Pêne acier zingué. Gâche plate acier. Carré 7 mm, entr'axe 70 mm. 1 clé - 6 variées.

Stamped steel case 10 mm thickness. Steel forend. Reversible zinc plated alloy latch without removing the case. Zinc plated steel bolt. Steel flat striker. Square 7 mm. 1 key - 6 different keys.

Caja de acero embutido 10 mm de espesor. Cabeza de acero. Media vuelta de aleación cincado reversible sin desmontar la caja. Pestillo de acero cincado. Cerradero plano de acero. Cuadrado 7 mm. 1 llave - 6 perfiles de llave.

Finition/Finish/Acabado

Epoxy blanc (V)Gris métal
White epoxy (V)Metal gray
Epoxi blanco (V)Metal gris

Designation	Boîte	Colis.	Prix	Sachet	Colis.	Prix	Brochable					Colis.	Prix
							France	Euro 1	Euro 2	Euro 3	Euro 4		
Serrure axe 50mm pêne dormant 1/2 tour coffre épaisseur 10 mm V/BR blanche 1 clé	-	-	-	00913932	10	-	00413932	-	-	-	-	5	-
Serrure axe 50mm pêne dormant 1/2 tour coffre épaisseur 10 mm BR gris métal 1 clé	-	-	-	00913935	10	-	-	-	-	-	-	-	-
Tarif conditionnement non décolisable													
Serrure axe 50mm pêne dormant 1/2 tour coffre épaisseur 10 mm V/BR blanche 1 clé (50 pièces non décolisable)	00013932	50	-	-	-	-	-	-	-	-	-	-	-
Serrure axe 50mm pêne dormant 1/2 tour coffre épaisseur 10 mm BR gris métal 1 clé (50 pièces non décolisable)	00013935	50	-	-	-	-	-	-	-	-	-	-	-

Axe à 50 mm / PÊNE DORMANT 1/2 TOUR

ECO

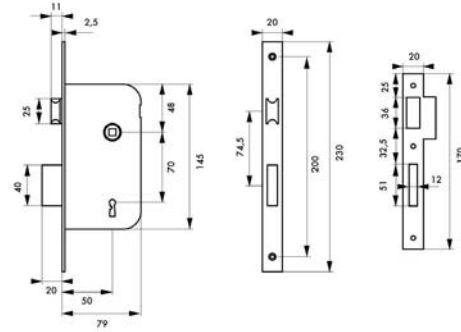

GARANTIE



X 1

Description/Description/Descripción

Coffre acier embouti épaisseur 11 mm. Tête acier bouts ronds. Demi-tour réversible sans démontage. du coffre. Pêne alliage zingué bichromaté. Gâche plate acier. Mécanisme à 2 tours. Carré 7 mm, entraxe 70 mm. 1 clé. 12 variures.

Stamped steel case thickness 11 mm. Steel forend. Reversible latch without removing the case. Bichromated zinc plated alloy bolt. Steel flat striker. Double deadbolt throw. Square 7 mm. 1 key - 12 different keys.

Caja de acero embutido espesor 11 mm. Cabeza de acero. Media vuelta reversible sin desmontar la caja. Pestillo de aleación cincada bicromatada. Cerradero plano de acero. Mecanismo de 2 vueltas. Cuadrado 7 mm. 1 llave - 12 perfiles de llave.

Finition/Finish/Acabado

Epoxy noir granité (V)

Black epoxy (V)

Epoxi negro granitado (V)

Designation	Boite	Colis.	Prix	Sachet	Colis.	Prix	Brochable					Colis.	Prix
							France	Euro 1	Euro 2	Euro 3	Euro 4		
Serrure axe 50mm pêne dormant 1/2 tour 2 tours V/ BR 1 clé	-	-	-	00901202	10	-	00401202	-	-	-	-	10	-

Axe à 50 mm / PÊNE DORMANT 1/2 TOUR

ECO

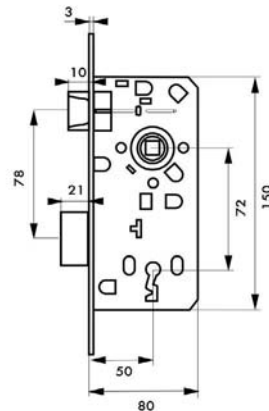

GARANTIE



X 1

Description/Description/Descripción

Coffre acier embouti. Tête acier bouts ronds. Demi-tour réversible sans démontage du coffre. Pêne alliage zingué. Gâche plate acier. Mécanisme à 2 tours. Carré 8 mm, entraxe 72 mm. 1 clé. 12 variures.

Stamped steel case. Steel forend. Reversible latch without removing the case. Zinc plated alloy bolt. Steel flat striker. Double deadbolt throw. Carré 8 mm. 1 key - 12 different keys.

Caja de acero embutido. Cabeza de acero. Media vuelta reversible sin desmontar la caja. Pestillo de aleación cincada. Cerradero plano de acero. Mecanismo de 2 vueltas. Cuadrado 8 mm. 1 llave - 12 perfiles de llave.

Finition/Finish/Acabado

Zingué

Zinc coated

Cincado

Designation	Boite	Colis.	Prix	Sachet	Colis.	Prix	Brochable					Colis.	Prix
							France	Euro 1	Euro 2	Euro 3	Euro 4		
Serrure axe 50mm pêne dormant 1/2 tour 2 tours entraxe 72mm Z/BR 1 clé	00093663 NS	1	-	-	-	-	-	00493663	-	-	-	5	-

NS Non stocké/Non-stored/Producto no estocado - E Sur stock Europe Zone 1 et Zone 2, nous consulter pour délai d'approvisionnement - E Epuisement/Stock depletion/Agotamiento del stock

Axe à 50 mm / PÊNE DORMANT 1/2 TOUR ECO

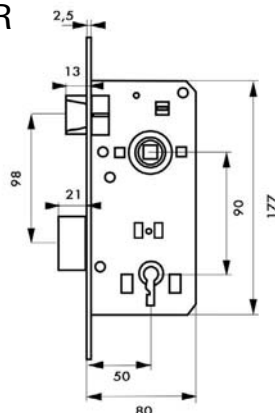

GARANTIE



X 2

Description/Description/Descripción

Coffre acier embouti. Têtière acier bouts ronds. Demi-tour réversible sans démontage du coffre. Pêne alliage zingué. Gâche plate acier. Carré 8 mm, entr'axe 90 mm. 2 clés. Sans rappel du 1/2 tour par la clé.
Stamped steel case. Steel forend. Reversible latch without removing the case. Zinc plated alloy bolt. Steel flat striker. Square 8 mm. 2 keys. Without drawback of the latch by the key.

Caja de acero embutido. Cabeza de acero. Media vuelta reversible sin desmontar la caja. Pestillo de aleación cincada. Cerradero plano de acero. Cuadrado 8 mm. 2 llaves. No reposición de la media vuelta con llave.

Finition/Finish/Acabado

Zingué
Zinc coated
Cincado

Designation	Boite	Colis.	Prix	Sachet	Colis.	Prix	Brochable					Colis.	Prix
							France	Euro 1	Euro 2	Euro 3	Euro 4		
Serrure axe 50mm pêne dormant 1/2 tour 2 tours entraxe 90mm Z/BR 2 clés	-	-	-	-	-	-	-	00493309 NS	00492309 NS	-	-	5	-

Axe à 50 mm / MAGNETIQUE, PÊNE DORMANT 1/2 TOUR PROTECT

CONFORT D'UTILISATION : silence de fonctionnement - pas de pêne en saillie

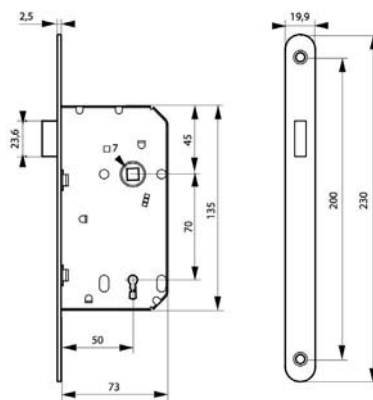

GARANTIE



X 1

Description/Description/Descripción

Coffre acier embouti. Têtière acier bouts ronds. Système magnétique à pêne rétractable. Gâche plate acier. Carré 7 mm, entr'axe 70 mm. 1 clé.
Pressed steel safe. Steel rounded head forend. Magnetic system with retractable bolt. Steel flat strike. Square 7 mm. 1 key.

redondos. Sistema magnético de pestillo retraíble. Gacheta plana de acero. Cuadrado 7 mm. 1 llave.

Finition/Finish/Acabado

Fer satiné
Satin iron
Hierro satinado

Caja de acero embutido. Cabeza de acero extremos

Designation	Boite	Colis.	Prix	Sachet	Colis.	Prix	Brochable					Colis.	Prix
							France	Euro 1	Euro 2	Euro 3	Euro 4		
Serrure axe 50mm magnétique pêne dormant 1/2 tour 1 clé /BR	-	-	-	00901552	10	-	00401552	-	-	-	-	5	-

Ⓜ Non stocké/Non-stored/Producto no estocado - Ⓜ Sur stock Europe Zone 1 et Zone 2, nous consulter pour délai d'approvisionnement - Ⓜ Epuement/Stock depletion/Agotamiento del stock

Axe à 50 mm / PÊNE DORMANT 1/2 TOUR

PROTECT



Tête amovible et nombreuses finitions disponibles

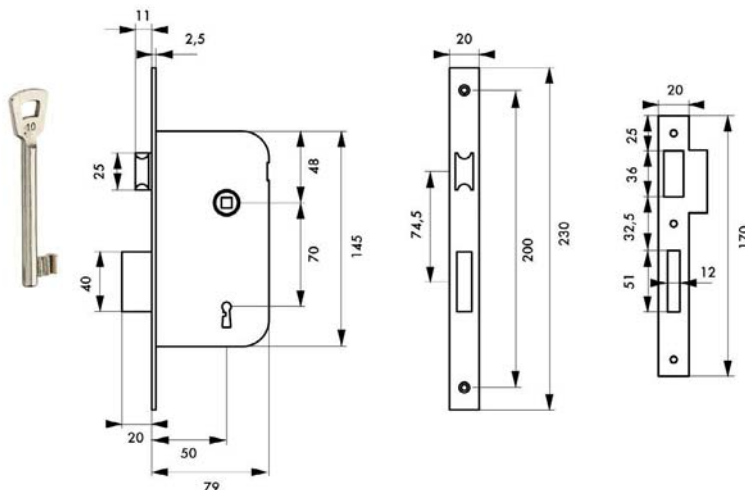

GARANTIE



X 1

Description/Description/Descripción

Coffre acier embouti. Tête acier. Demi-tour réversible sans démontage du coffre. Pêne alliage zingué. Gâche plate acier. Mécanisme à 2 tours. Carré 7 mm, entr'axe 70 mm. 1 clé. 10 variures.

Stamped steel case. Steel forend. Reversible latch without removing the case. Zinc plated alloy bolt. Steel flat striker. One deadbolt throw. Square 7 mm. 1 key - 10 different keys.

Caja de acero embutido. Cabeza de acero. Media vuelta reversible sin desmontar la caja. Pestillo de aleación cincada. Cerradero plano de acero. Mecanismo de 1 vuelta. Cuadrado 7 mm. 1 llave - 10 perfiles de llave.

Finition/Finsh/Acabado

Epoxy noir (V) - Zingué (Z)
Black epoxy (V) - Zinc plated (Z)
Epoxi negro (V) - Cincado (Z)

Version/Option/Versión

Tête bouts carrés (BC). Tête bouts ronds (BR). Tête acier nickelé. Tête laiton brossé. Tête laiton poli verni. Tête laiton poli nickelé.

Square (BC). Round (BR) ended forend. Nickel plated steel forend. Brushed brass forend. Varnish polished brass forend. Polish nickel plated brass forend.

Cabeza de extremos cuadrados (BC). Cabeza de extremos redondos (BR). Cabeza de acero niquelado. Cabeza de latón cepillado. Cabeza de latón pulido barnizado. Cabeza de latón pulido niquelado.

Designation	Boite	Colis.	Prix	Sachet	Colis.	Prix	Brochable					Colis.	Prix
							France	Euro 1	Euro 2	Euro 3	Euro 4		
Serrure axe 50mm pêne dormant 1/2 tour V/BC/Z - 1 clé	00000202	5	-	-	-	-	-	-	-	-	-	-	-
Serrure axe 50mm pêne dormant 1/2 tour V/BR/Z - 1 clé	00001202	5	-	-	-	-	-	-	-	-	-	-	-
Serrure axe 50mm pêne dormant 1/2 tour tête acier nickelé V/BR/L - 1 clé	00019322 NS	5	-	-	-	-	-	-	-	-	-	-	-
Serrure axe 50mm pêne dormant 1/2 tour Z/BC/Z - 1 clé	00010202	5	-	-	-	-	-	-	-	-	-	-	-
Serrure axe 50mm pêne dormant 1/2 tour Z/BR/Z - 1 clé	00011202	5	-	-	-	-	-	-	-	-	-	-	-
Serrure axe 50mm pêne dormant 1/2 tour tête laiton poli verni V/BR/L - 1 clé	00019222	5	-	-	-	-	-	-	-	-	-	-	-
Serrure axe 50mm pêne dormant 1/2 tour tête laiton poli nickelé V/BR/L - 1 clé	00019212	5	-	-	-	-	-	-	-	-	-	-	-

NS Non stocké/Non-stored/Producto no estocado - E Sur stock Europe Zone 1 et Zone 2, nous consulter pour délai d'approvisionnement - E Epuisement/Stock depletion/Agotamiento del stock

Axe à 50 mm /PÊNE DORMANT 1/2 TOUR

RESIST

Caractéristiques certifiées NF :
endurance, durabilité, sécurité.



Essais selon la norme NF

EN 12209

Classification

3 S 4 0 0 G 3 H F 3 0

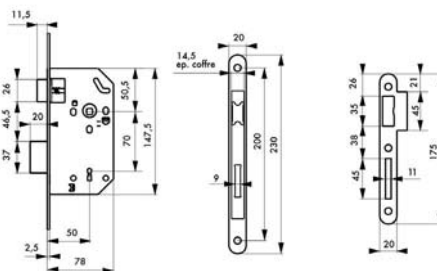

GARANTIE



X 1

Description/Description/Descripción

Coffre acier embouti. Tête acier bouts ronds. Demi-tour bipente alliage réversible sans démontage du coffre. Pêne acier galvanisé. Gâche plate acier zingué. Mécanisme à 2 tours. Carré 7 mm, entr'axe 70 mm. 1 clé. 4 Variures.

Stamped steel case. Round ended steel forend. Reversible alloy latch without removing the case. Galvanised steel bolt. Zinc plated steel flat striker. Double deadbolt throw. Draw back of the latch by key. Square 7 mm.

Caja de acero embutido. Cabeza de extremos redondos. Media vuelta de aleación reversible sin desmontar la caja. Pestillo de acero galvanizado. Cerradero plano de acero cincado. Mecanismo de 2 vueltas. Reposición de la

media vuelta con la llave. Cuadrado 7 mm.

Finition/Finish/Acabado

Coffre galvanisé, tête epoxy noir granité
Case galvanised, forend black epoxy
Caja galvanizado, cabeza epoxi negro

Version/Option/Versión

Tête inox, acier laitonné, acier nickelé. Possibilité carré 8 mm sur demande.

Stainless steel forend, brass plated forend, nickel plated forend. Square 8 mm on request.

Cabeza de acero inoxidable, acero latonado, acero niquelado. Cuadrado 8 mm a petición.

Designation	Boite	Colis.	Prix	Sachet	Colis.	Prix	Brochable					Colis.	Prix
							France	Euro 1	Euro 2	Euro 3	Euro 4		
Serrure MONOMAX NF axe 50mm pêne dormant 1/2 tour tête noire BR 1 clé	00556820	5	-	00956820	20	-	00456820	-	-	-	-	5	-
Serrure MONOMAX NF axe 50mm pêne dormant 1/2 tour tête noire BC 1 clé	00556920	5	-	-	-	-	-	-	-	-	-	-	-
Serrure MONOMAX NF axe 50mm pêne dormant 1/2 tour tête inox BR 1 clé	00556821	5	-	-	-	-	00456821	-	-	-	-	5	-
Serrure MONOMAX NF axe 50mm pêne dormant 1/2 tour tête acier laitonné BR 1 clé	00556822	5	-	-	-	-	-	-	-	-	-	-	-
Serrure MONOMAX NF axe 50mm pêne dormant 1/2 tour tête acier nickelé BR 1 clé	00556823	5	-	-	-	-	-	-	-	-	-	-	-

Tarif conditionnement non décolisable

Serrure MONOMAX NF axe 50mm pêne dormant 1/2 tour tête noire BR 1 clé - sans gâche (25 pièces non décolisable)	00056820	25	-	-	-	-	-	-	-	-	-	-	-
Gâche acier pour serrure NORME NF à pêne dormant 1/2 tour (25 pièces non décolisable)	00046102	25	-	-	-	-	-	-	-	-	-	-	-
Serrure MONOMAX NF axe 50mm pêne dormant 1/2 tour tête inox BR 1 clé - sans gâche (25 pièces non décolisable)	00056821	25	-	-	-	-	-	-	-	-	-	-	-
Gâche inox pour serrure NORME NF à pêne dormant 1/2 tour (25 pièces non décolisable)	00046103	25	-	-	-	-	-	-	-	-	-	-	-

Ⓜ Non stocké/Non-stored/Producto no estocado - Ⓜ Sur stock Europe Zone 1 et Zone 2, nous consulter pour délai d'approvisionnement - Ⓜ Epuisement/Stock depletion/Agotamiento del stock

Axe à 55 mm / PÊNE DORMANT 1/2 TOUR «ALSACE» ECO



GARANTIE



X 1

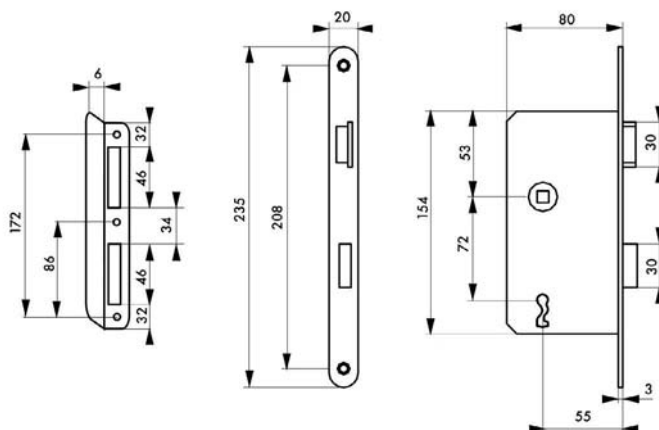

Description/Description/Descripción

Coffre acier cambré. Tête acier bouts ronds. Demi-tour polyamide. Fouillot polyamide. Pêne polyamide. Mécanisme à 1 tour. Carré 8 mm. Gâche équerre acier. (Demi-tour et pêne zamak : réf. 055006, 055016).

Cambered steel case. Round ended steel forend. Polyamid latch. Polyamid follower. Polyamid bolt. One latch mechanism. Square 8 mm. Angle steel striker. (Zamak latch and bolt : ref. 055006, 055016)

Caja de acero curvado. Cabeza de acero de extremos redondos. Media vuelta de poliamida. Nuez de poliamida. Pestillo de poliamida. Mecanismo de 1 vuelta con reposición de la media vuelta con la llave. Cuadrado 8 mm. Cerradero escuadra de acero. (Media vuelta y pestillo zamak : ref. 055006, 055016)

Finition/Finish/Acabado

Tête vernie - Coffre zingué

Varnished forend - Zinc plated case

Cabeza barnizada - Caja cincada

Version/Option/Versión

Droite ou gauche - A condanmation

Right or left hand - With locking for bathroom

Derecha o izquierda - De condenación

Designation	Boite	Colis.	Prix	Sachet	Colis.	Prix	Brochable					Colis.	Prix
							France	Euro 1	Euro 2	Euro 3	Euro 4		
Serrure axe 50mm pêne dormant 1/2 tour entraxe 72 mm droite 1 clé	00055002	1	-	00955002	20	-	00455002	00493227 [E] [NS] [M]	00492227 [E] [NS] [M]	00494227	-	5	-
Serrure axe 50mm pêne dormant 1/2 tour entraxe 72 mm gauche 1 clé	00055012	1	-	00955012	20	-	00455012	00493228 [E] [NS] [M]	00492228 [E] [NS] [M]	00494228	-	5	-

[NS] Non stocké/Non-stored/Producto no estocado - [M] Sur stock Europe Zone 1 et Zone 2, nous consulter pour délai d'approvisionnement - [E] Epuisement/Stock depletion/Agotamiento del stock

Axe à 55 mm / PÊNE DORMANT 1/2 TOUR

ECO

DISPONIBLE JUSQU'À
ÉPUISEMENT DES STOCKS



GARANTIE



X 1

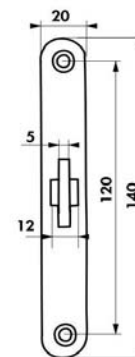
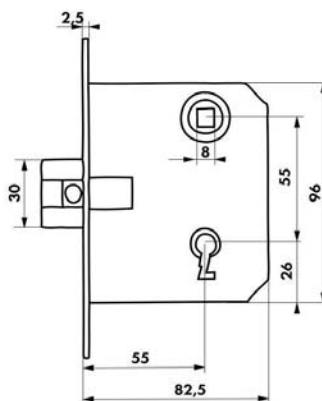

Description/Description/Descripción

Coffre acier embouti. Têtière acier bouts ronds. Réversible. Pêne alliage zingué. Gâche équerre acier. Carré 8 mm, entr'axe 55 mm. 1 clé. Rappel du 1/2 tour par la clé.
Stamped steel case. Steel forend. Reversible. Zinc plated alloy bolt. Angle steel striker. Square 8 mm. 1 key. Draw back of the latch by key.

Caja de acero embutido. Cabeza de acero. Reversible. Pestillo de aleación cincada. Cerradero escuadra de acero. Cuadrado 8 mm. 1 llave. Reposición de la media vuelta con la llave.

Finition/Finish/Acabado

Zingué
Zinc coated
Cincado

Designation	Boîte	Colis.	Prix	Sachet	Colis.	Prix	Brochable				Colis.	Prix	
							France	Euro 1	Euro 2	Euro 3			Euro 4
Serrure axe 55mm pêne dormant 1/2 tour entraxe 55mm tèteière laitonée BR 1 clé	-	-	-	-	-	-	-	-	00492311 NS	-	-	5	-

NS Non stocké/Non-stored/Producto no estocado - Sur stock Europe Zone 1 et Zone 2, nous consulter pour délai d'approvisionnement - E Epuisement/Stock depletion/Agotamiento del stock

Axe à 22 mm / A ROULEAU RESIST



GARANTIE

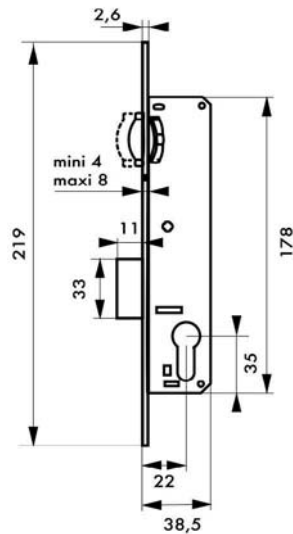

Description/Description/Descripción

Coffre acier embouti. Tête acier bouts ronds. Pêne alliage zingué. Gâche plate acier.
Stamped steel case. Steel forend. Zinc plated alloy bolt. Steel flat striker.

Caja de acero embutido. Cabeza de acero. Pestillo de aleación cincada. Cerradero plano de acero.

Finition/Finish/Acabado

Noir
Black
Negro

Designation	Boite	Colis.	Prix	Sachet	Colis.	Prix	Brochable					Colis.	Prix
							France	Euro 1	Euro 2	Euro 3	Euro 4		
Boîtier serrure axe 22mm à cyl. à rouleau V/BR	00093658 NS	1	-	-	-	-	-	00493658 NS	-	-	-	5	-

NS Non stocké/Non-stored/Producto no estocado - Sur stock Europe Zone 1 et Zone 2, nous consulter pour délai d'approvisionnement - E Epusement/Stock depletion/Agotamiento del stock

Axe à 50 mm / A ROULEAU

ECO



GARANTIE



X 3

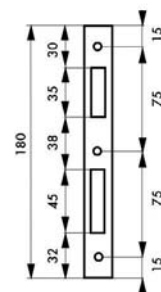
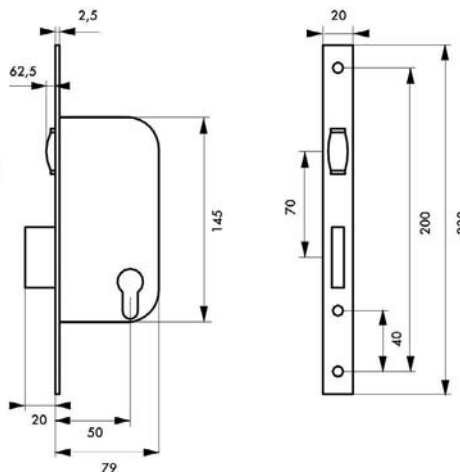

Description/Description/Descripción

Coffre acier embouti. Têtière acier. Rouleau laiton. Gâche plate acier.

Stamped steel case. Steel forend. Brass roller. Steel flat striker

Caja de acero embutido. Cabeza de acero. Rodillo de latón. Cerradero plano de acero.

Finition/Finish/Acabado

Epoxy noir (V)

Black epoxy (V)

Epoxi negro granitado (V)

Version/Option/Versión

Têtière bouts carrés (BC). Têtière bouts ronds (BR). Têtière et gâche laiton. Têtière et gâche inox. Avec cylindre profilé européen 30 x 30 mm, 3 clés.

Square (BC) and round (BR) ended forend. Brass forend and striker. Stainless steel forend and striker with european profile cylinder 30 x 30 mm, 3 keys.

Cabeza de extremos cuadrados (BC) Cabeza de extremos redondos (BR). Cabeza y cerradero plano de latón. Cabeza y cerradero plano de acero inoxidable. Con cilindro perfilado europeo 30 x 30 mm, 3 llaves.

Designation	Boite	Colis.	Prix	Sachet	Colis.	Prix	Brochable					Colis.	Prix
							France	Euro 1	Euro 2	Euro 3	Euro 4		
Serrure à rouleau axe 50mm à cylindre profilé V/BC 3 clés	00000289	10	-	-	-	-	-	-	-	-	-	-	-
Serrure à rouleau axe 50mm à cylindre profilé V/BR 3 clés	-	-	-	00901289	10	-	-	-	-	-	-	-	-
Boîtier serrure à rouleau axe 50mm à cylindre V/BC	00010289	10	-	-	-	-	00410289	-	-	-	-	5	-
Boîtier serrure à rouleau axe 50mm à cylindre V/BR	00011289	10	-	00911289	10	-	00411289	-	-	-	-	5	-
Boîtier serrure à rouleau axe 50mm à cylindre tête et gâche laiton V/BR	00012289	1	-	-	-	-	-	-	-	-	-	-	-
Boîtier serrure à rouleau axe 50mm à cylindre tête et gâche inox V/BR	00013289	1	-	-	-	-	-	-	-	-	-	-	-

Non stocké/Non-stored/Producto no estocado - Sur stock Europe Zone 1 et Zone 2, nous consulter pour délai d'approvisionnement - Epuisement/Stock depletion/Agotamiento del stock

A ROULEAU PROTECT



GARANTIE

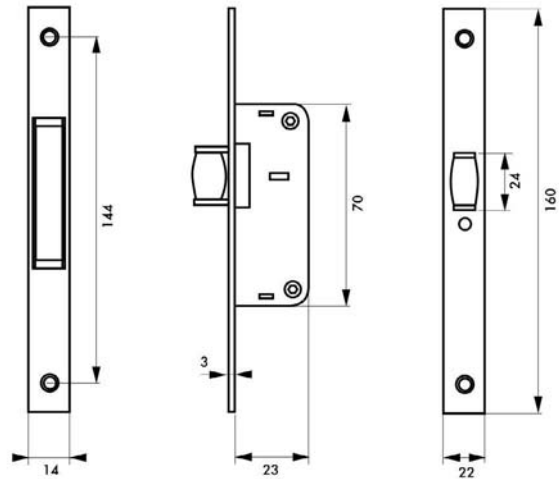

Description/Description/Descripción

Coffre acier zingué plastifié. Tête acier nickelé chromé largeur 22mm. Rouleau laiton nickelé.

Zinc and plastic plated steel case. Nickel and chromium plated steel forend 22mm wide. Nickel plated brass roller.

Caja de acero galvanizado recubierto de plástico. Cabeza de acero cromado 22mm de ancho. Rodillo de latón niquelado.

Finition/Finish/Acabado

Noir

Black

Negro

Version/Option/Versión

Porte menuiserie métallique

Metal joinerie

Puertas de carpintería metálica

Designation	Boite	Colis.	Prix	Sachet	Colis.	Prix	Brochable					Colis.	Prix
							France	Euro 1	Euro 2	Euro 3	Euro 4		
Serrure à encastrer à rouleau	00013919	5	-	-	-	-	-	-	-	-	-	-	-

⚠ Non stocké/Non-stored/Producto no estocado - 📦 Sur stock Europe Zone 1 et Zone 2, nous consulter pour délai d'approvisionnement - 🇪🇺 Epuisement/Stock depletion/Agotamiento del stock

Axe à 40 mm / A MENTONNET ECO



GARANTIE

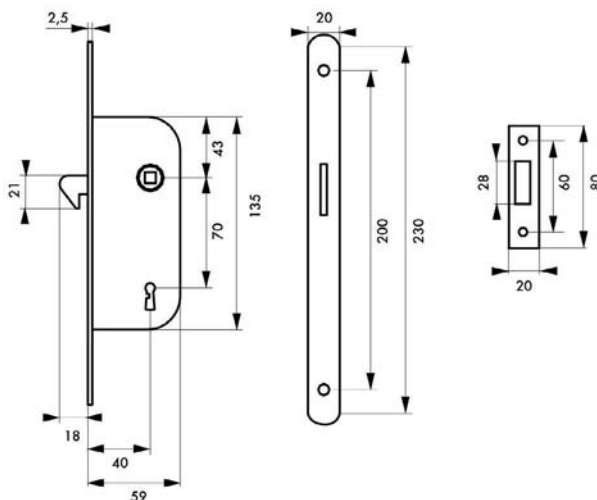

Description/Description/Descripción

Coffre acier embouti. Tête acier bouts ronds. Pêne crochet acier. Gâche plate acier. Carré 7 mm, entr'axe 70 mm. 2 clés (réf 001286).

Stamped steel case. Round steel forend. Steel hook. Steel flat striker. Square 7 mm. 2 keys (ref 001286).

Caja de acero embutido. Cabeza de acero de extremos redondos. Pestillo de gancho de acero. Cerradero plano de acero. Cuadrado 7 mm. 2 llaves (ref 001286).

Finition/Finish/Acabado

Epoxy blanc
White epoxy
Epoxi blanco

Version/Option/Versión

Sans clé - A condamnation

Without key - With locking

Sin llave - De condenación

Utilisation/Use/Utilización

Porte intérieure coulissante

Inside sliding door

Puertas interiores correderas

Designation	Boite	Colis.	Prix	Sachet	Colis.	Prix	Brochable					Colis.	Prix
							France	Euro 1	Euro 2	Euro 3	Euro 4		
Serrure axe 40mm bec de cane à mentonnet V/BR	-	-	-	00901287	10	-	00401287	-	-	-	-	5	-
Serrure axe 40mm à condamnation à mentonnet V/BR	-	-	-	00901285	10	-	-	-	-	-	-	-	-
Serrure axe 40mm pêne dormant 1/2 tour à mentonnet V/BR 2 clés	00001286	10	-	00901286	10	-	00401286	-	-	-	-	5	-

Non stocké/Non-stored/Producto no estocado - Sur stock Europe Zone 1 et Zone 2, nous consulter pour délai d'approvisionnement - Epuement/Stock depletion/Agotamiento del stock

Axe à 40 mm / GALANDAGE

PROTECT



GARANTIE

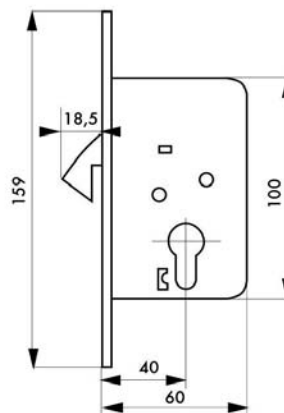

Description/Description/Descripción

Coffre acier embouti épaisseur 11 mm. Tête acier bouts ronds. Pêne crochet. Gâche plate acier. Poignées cuvette et tirage sur champs (sauf version à cylindre). Modèle à condamnation. Carré de 8 mm, ensemble verrouillage / déverrouillage. Pour porte ép. 50 mm maxi. Stamped steel case thickness 11 mm. Steel forend. Hook. Steel flat striker. Square 8 mm. For 50 mm thickness door max.

Caja de acero embutido espesor 11 mm. Cabeza de acero. Pestillo de gancho. Cerradero plano de acero. Cuadrado 8 mm. Para puerta de 50 mm max.

Finition/Finish/Acabado

Chromé satin, laitonné

Nickel plated, brass plated

Niquel terciopelo, latonado

Version/Option/Versión

A condamnation. A clé articulée. A cylindre (livrée sans cuvette ni tirage).

With locking for bathroom. With key. With profile cylinder (without accessories).

De condenación. Con llave. De cilindro perfilado (sin accesorios).

Utilisation/Use/Utilización

Porte coulissante

Sliding door

Puertas correderas

Designation	Boite	Colis.	Prix	Sachet	Colis.	Prix	Brochable					Colis.	Prix
							France	Euro 1	Euro 2	Euro 3	Euro 4		
Boîtier serrure axe 40mm à crochet pour porte coulissante, nickelé	00003108	1	-	-	-	-	00303108	-	00492333 NS	-	-	5	-
Boîtier serrure axe 40mm à crochet pour porte coulissante, laitonnée	00003109	1	-	-	-	-	00303109	-	00492334 NS	-	-	5	-
Accessoires pour serrure à crochet porte coulissante, nickelé	-	-	-	-	-	-	00301114	-	-	-	-	5	-
Tirage pour serrure à crochet, nickelé	00001107	10	-	-	-	-	-	-	-	-	-	-	-
Tirage pour serrure à crochet, laitonné	00001197	10	-	-	-	-	-	-	-	-	-	-	-
Jeu de poignées cuvette rondes, nickelé	00002107	10	-	-	-	-	-	-	-	-	-	-	-
Jeu de poignées cuvette rondes, laitonné	00002197	10	-	-	-	-	-	-	-	-	-	-	-

NS Non stocké/Non-stored/Producto no estocado - ☐ Sur stock Europe Zone 1 et Zone 2, nous consulter pour délai d'approvisionnement - ☒ Epuisement/Stock depletion/Agotamiento del stock

Axe à 50 mm / GALANDAGE

PROTECT



GARANTIE

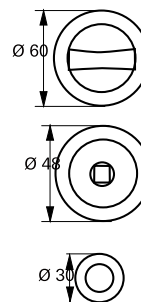
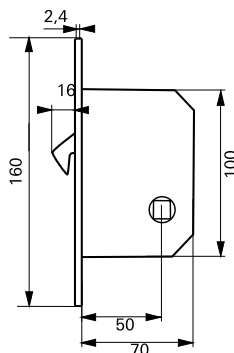
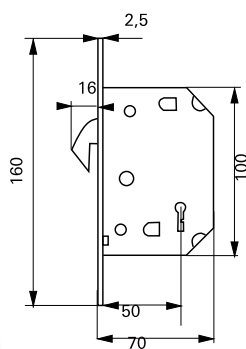

Description/Description/Descripción

Coffre acier embouti épaisseur 11 mm. Tête acier bouts ronds. Pêne crochet. Gâche plate acier. Poignées cuvette et tirage sur champs. Modèle à condamnation : Carré de 8 mm, ensemble verrouillage / déverrouillage. Pour porte ép. 50 mm maxi.

Stamped steel case thickness 11 mm. Steel forend. Hook. Steel flat striker. Square 8 mm. For 50 mm thickness door max.

Caja de acero embutido espesor 11 mm. Cabeza de acero. Pestillo de gancho. Cerradero plano de acero. Cuadrado 8 mm. Para puerta de 50 mm max.

Finition/Finish/Acabado

Chromé satin, laitoné
Nickel plated, brass plated

Niquel terciopelo, latonado

Version/Option/Versión

A condamnation. A clé articulée. A cylindre (livrée sans cuvette ni tirage).

With locking for bathroom. With key. With profile cylinder (without accessories).

De condenación. Con llave. De cilindro perfilado (sin accesorios).

Utilisation/Use/Utilización

Porte coulissante

Sliding door

Puertas correderas

Designation	Boite	Colis.	Prix	Sachet	Colis.	Prix	Brochable					Colis.	Prix
							France	Euro 1	Euro 2	Euro 3	Euro 4		
Serrure axe 50mm à crochet, à condamnation pour porte coulissante, nickelé	00001108	1	-	-	-	-	00301108	00493199 NS	00492199 NS	00494199	-	5	-
Serrure axe 50mm à crochet, à condamnation pour porte coulissante, laitoné	00001109	1	-	-	-	-	00301109	00493325 NS	00492325 NS	00494325	-	5	-
Serrure axe 50mm à crochet, à clé pour porte coulissante, nickelé	00002108	1	-	-	-	-	00302108	-	-	-	-	5	-
Serrure axe 50mm à crochet, à clé pour porte coulissante, laitoné	00002109	1	-	-	-	-	00302109	-	-	-	-	5	-
Serrure axe 50mm à crochet, à clé pour porte coulissante, nickelé, sans accessoires	-	-	-	-	-	-	00301112	-	-	-	-	5	-
Accessoires pour serrure à crochet porte coulissante, nickelé	-	-	-	-	-	-	00301114	-	-	-	-	5	-
Tirage pour serrure à crochet, nickelé	00001107	10	-	-	-	-	-	-	-	-	-	-	-
Tirage pour serrure à crochet, laitoné	00001197	10	-	-	-	-	-	-	-	-	-	-	-
Jeu de poignées cuvette rondes, nickelé	00002107	10	-	-	-	-	-	-	-	-	-	-	-
Jeu de poignées cuvette rondes, laitoné	00002197	10	-	-	-	-	-	-	-	-	-	-	-

NS Non stocké/Non-stored/Producto no estocado - Sur stock Europe Zone 1 et Zone 2, nous consulter pour délai d'approvisionnement - E Epuisement/Stock depletion/Agotamiento del stock

Axe à 50 mm / GALANDAGE PROTECT



GARANTIE

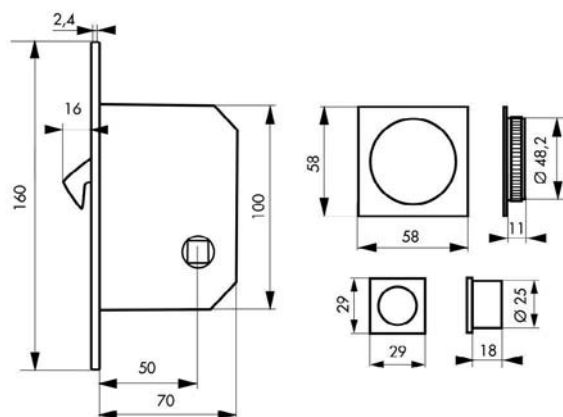

Description/Description/Descripción

Coffre acier embouti épaisseur 11 mm. Tête acier bouts ronds. Pêne crochet. Gâche plate acier. Poignées cuvette et doigt de tirage sur champs. Modèle à condamnation : carré de 8 mm. Pour porte ép. 50 mm maxi.
Stamped steel case thickness 11 mm. Steel forend. Hook. Steel at striker. Square 8 mm. For 50 mm thickness door max.

Caja de acero embutido espesor 11 mm. Cabeza de acero. Pestillo de gancho. Cerradero plano de acero. Cuadrado 8 mm. Para puerta de 50 mm max.

Finition/Finish/Acabado

Nickelé
Nickel plated
Niquelado

Version/Option/Versión

A condamnation. A clé articulée.
With locking for bathroom. With key.
De condenación. Con llave.

Utilisation/Use/Utilización

Porte coulissante
Sliding door
Puertas correderas

Designation	Boite	Colis.	Prix	Sachet	Colis.	Prix	Brochable					Colis.	Prix
							France	Euro 1	Euro 2	Euro 3	Euro 4		
Serrure axe 50mm à crochet, à condamnation pour porte coulissante, rosaces carrés, nickelé	00001132	1	-	-	-	-	00301132	00493073	00492073	00494073	-	5	-
Serrure axe 50mm à crochet, à clé pour porte coulissante, rosaces carrés, nickelé	00001133	1	-	-	-	-	00301133	00493074	00492074	00494074	-	5	-
Accessoires pour porte coulissante, rosaces carrés, nickelé,	00001134	1	-	-	-	-	00301134	00393075	00392075	00394075	-	5	-

⚠ Non stocké/Non-stored/Producto no estocado - 📦 Sur stock Europe Zone 1 et Zone 2, nous consulter pour délai d'approvisionnement - 📦 Epuisement/Stock depletion/Agotamiento del stock

Axe à 50 mm / A MENTONNET PROTECT



GARANTIE



X 3

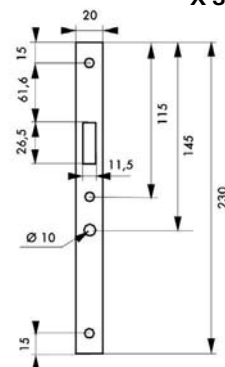
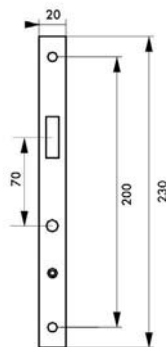
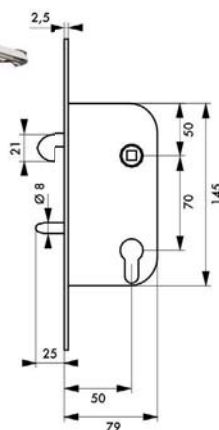

Description/Description/Descripción

Coffre acier embouti. Têtière acier. Pêne crochet laiton. Gâche plate acier. Carré 7 mm, entr'axe 70 mm. Rappel du crochet par la clé.

Stamped steel case. Steel forend. Brass Hook. Steel flat striker. Catch bolt. Square 7 mm.

Caja de acero embutido. Cabeza de acero. Pestillo de gancho de latón. Cerradero plano de acero. Cuadrado 7 mm.

Finition/Finish/Acabado

Epoxy noir
Black epoxy
Epoxi negro

Version/Option/Versión

Têtière bouts carrés (BC). Têtière bouts ronds (BR). Avec cylindre profilé européen. 30 x 30 mm, 3 clés.

Square (BC). Round (BR) ended forend. With european profile cylinder. 30 x 30 mm, 3 keys.

Cabeza de extremos cuadrados (BC). Cabeza de extremos redondos (BR). Con cilindro perfilado europeo. 30 x 30 mm, 3 llaves.

Utilisation/Use/Utilización

Porte coulissante
Sliding door
Puertas correderas

Designation	Boite	Colis.	Prix	Sachet	Colis.	Prix	Brochable					Colis.	Prix
							France	Euro 1	Euro 2	Euro 3	Euro 4		
Serrure axe 50mm à cylindre profilé, à mentonnet V/BC 3 clés	00000288	10	-	-	-	-	-	-	-	-	-	-	-
Serrure axe 50mm à cylindre profilé, à mentonnet V/BR 3 clés	00001288	10	-	-	-	-	-	-	-	-	-	-	-
Boîtier serrure axe 50mm à cylindre, à mentonnet V/BC	00010288	10	-	-	-	-	00410288	-	-	-	-	5	-
Boîtier serrure axe 50mm à cylindre, à mentonnet V/BR	00011288	10	-	00911288	10	-	00411288	-	-	-	-	5	-

Non stocké/Non-stored/Producto no estocado - Sur stock Europe Zone 1 et Zone 2, nous consulter pour délai d'approvisionnement - Epuement/Stock depletion/Agotamiento del stock

Entraxe 70 mm / POUR PORTAIL RESIST

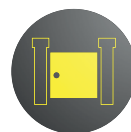

GARANTIE



Description/Description/Descripción

Coffre ABS épaisseur 22 mm. Têtière inox. Pêne réglable de 15 mm par vis. Demi-tour réversible sans démontage du coffre. Rappel du 1/2 tour par la clé. Carré 7 mm
ABS case thickness 22 mm. Stainless steel forend. Adjustable bolt 15 mm with screw. Push or draw reversible, right or left hand. Square 7 mm.

Caja de ABS espesor 22 mm. Cabeza de acero inoxidable. Pestillo regulable de 15 mm mediante tornillo. Reversible tirando / empujando, derecha / izquierda. Cuadrado 7 mm.

Finition/Finish/Acabado

Noir
 Black
 Negro

Version/Option/Versión

Portail bois, PVC, aluminium

Wooden, aluminium and PVC gates

Para todo tipo de portales de madera, aluminio y PVC

Utilisation/Use/Utilización

Portail bois, PVC, aluminium

Wooden, aluminium and PVC gates

Para todo tipo de portales de madera, aluminio y PVC

Designation	Boite	Colis.	Prix	Sachet	Colis.	Prix	Brochable					Colis.	Prix
							France	Euro 1	Euro 2	Euro 3	Euro 4		
Boîtier de serrure à encastrer pour cylindre profilé axe 40 mm	00013941	1	-	00913941	10	-	00413941	-	-	-	-	10	-
Béquille double pour serrure de portail	00013942	1	-	-	-	-	00213942	-	-	-	-	10	-
Plaque de propreté pour serrure de portail	00013943	1	-	-	-	-	00413943	-	-	-	-	10	-

⚠ Non stocké/Non-stored/Producto no estocado - ☑ Sur stock Europe Zone 1 et Zone 2, nous consulter pour délai d'approvisionnement - ☒ Epuisement/Stock depletion/Agotamiento del stock

Entraxe 72 mm / POUR PORTAIL

PROTECT

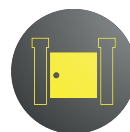

GARANTIE

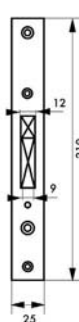
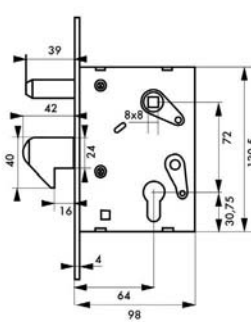
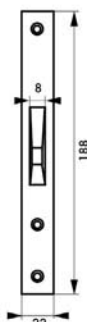
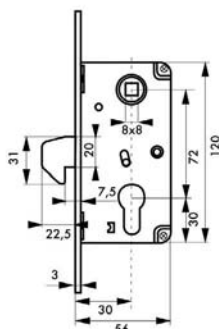

Description/Description/Descripción

Coffre acier zingué épaisseur 20 mm. Têtière acier zingué. Pêne crochet. Gâche plate acier zingué. Carré de 8 mm entr'axe 72 mm. Sans rappel du 1/2 tour par la clé.
Zinc coated steel case thickness 20 mm. Zinc coated steel forend. Hook. Zinc coated steel flat striker. Square 8 mm. Without drawback of the latch by the key.
 Caja de acero cincado espesor 20 mm. Cabeza de acero cincado. Pestillo de gancho. Cerradero plano de acero cincado. Cuadrado 8 mm. No reposición de la media vuelta con llave

Finition/Finish/Acabado

Zingué
Zinc coated
 Cincado

Version/Option/Versión

Axe 30 et 40 - Axe 64
Axis 30 and 40 - Axis 64
 Eje 30 y 40 - Eje 64

Utilisation/Use/Utilización

Pour portail
Metal joinerie, sliding door
 Puertas corredera de carpintería metálica



Designation	Boite	Colis.	Prix	Sachet	Colis.	Prix	Brochable					Colis.	Prix
							France	Euro 1	Euro 2	Euro 3	Euro 4		
Serrure axe 30mm à cylindre entraxe 72mm, à crochet	-	-	-	00997030	10	-	00497030	00993326 [E] [NS] [C]	00992326 [NS] [C]	00994326 [E]	-	5	-
Serrure axe 40mm à cylindre entraxe 72mm, à crochet	-	-	-	00997040	10	-	00497040	00993327 [E] [NS] [C]	00992327 [NS] [C]	00994327	-	5	-
Serrure axe 64mm à cylindre entraxe 72mm, à crochet	-	-	-	00997064	10	-	00497064	00993328 [E] [NS] [C]	00992328 [NS] [C]	00994328	-	5	-
Coffre pour serrure à crochet 097064 pour tube 40 axe 20 mm	-	-	-	00997103	10	-	00297103	00993329 [E] [NS] [C]	00992329 [NS] [C]	00994329 [E]	-	5	-
Coffre pour serrure à crochet 097064 pour tube 50 axe 10 mm	-	-	-	00997102	10	-	00297102	00993330 [E] [NS] [C]	00992330 [NS] [C]	00994330 [E]	-	5	-
Poignée pour serrure à crochet	-	-	-	00997100	10	-	00297100	00993331 [E] [NS] [C]	00992331 [NS] [C]	00994331 [E]	-	5	-

[NS] Non stocké/Non-stored/Producto no estocado - [C] Sur stock Europe Zone 1 et Zone 2, nous consulter pour délai d'approvisionnement - [E] Epuisement/Stock depletion/Agotamiento del stock

Axe à 40 mm / FOUILLOT 6 X 9 MM PROTECT



GARANTIE

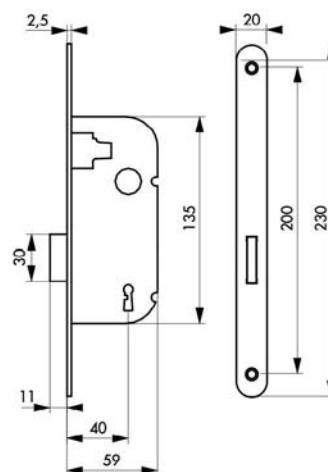

Description/Description/Descripción

Coffre acier embouti. Tête acier. Pêne acier. Gâche plate acier. Mécanisme à 1 tour. Fouillot 6 x 9 mm.
Stamped steel case. Steel forend. Steel bolt. Steel flat striker. One deadbolt throw. Square 6 x 9 mm.
 Caja de acero embutido. Cabeza de acero. Pestillo de acero. Cerradero plano de acero. Mecanismo de 1 vuelta. Cuadrado 6 x 9 mm.

Finition/Finish/Acabado

Epoxy blanc (V)
 White epoxy (V)
 Epoxi blanco (V)

Designation	Boite	Colis.	Prix	Sachet	Colis.	Prix	Brochable					Colis.	Prix
							France	Euro 1	Euro 2	Euro 3	Euro 4		
Serrure axe 40mm pêne dormant 1/2 tour V/BR fouillot 6 x 9 mm	00010190	10	-	-	-	-	-	-	-	-	-	-	-
Serrure axe 40mm pêne dormant seul V/BR fouillot 6 x 9 mm	00010191	10	-	-	-	-	-	-	-	-	-	-	-
Clé rectangulaire 9 mm	00013926	10	-	-	-	-	-	-	-	-	-	-	-

⚠ Non stocké/Non-stored/Producto no estocado - 📦 Sur stock Europe Zone 1 et Zone 2, nous consulter pour délai d'approvisionnement - 📦 Epuisement/Stock depletion/Agotamiento del stock

Axe à 40 mm / PÊNE DORMANT SEUL

PROTECT



GARANTIE

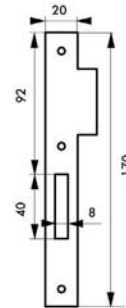
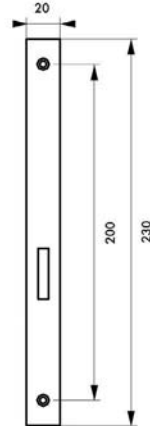
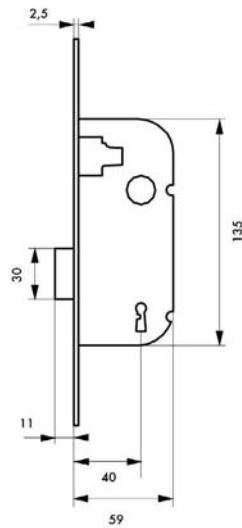

Description/Description/Descripción

Coffre acier embouti. Tête acier. Pêne acier. Gâche plate acier. Mécanisme à 1 tour. 1 clé. 6 variures. *Stamped steel case. Steel forend. Steel bolt. Steel flat striker. One deadbolt throw. 1 key. 6 different keys.*
Caja de acero embutido. Cabeza de acero. Pestillo de acero. Cerradero plano de acero. Mecanismo de 1 vuelta. 1 llave. 6 perfiles de llave.

Finition/Finish/Acabado

Epoxy blanc (V) - Zingué (Z)
White epoxy (V) - Zinc plated (Z)
Epoxi blanco (V) - Cincado (Z)

Version/Option/Versión

Fouillot 6 x 9 mm. Têteière bouts carrés (BC). Têteière bouts ronds (BR). Pour cylindre profilé.051197 - pêne zamak, livré sans gâche.

Square 6 x 9 mm. Square (BC). Round (BR) ended forend. For profile cylinder.051197 - zamak bolt, delivered without striker.

Cuadrado 6 x 9 mm. Cabeza de extremos cuadrados (BC). Cabeza de extremos redondos (BR). Para cilindro perfilado.051197 - pestillo de zamak, Entregada sin cerradero.

Designation	Boite	Colis.	Prix	Sachet	Colis.	Prix	Brochable					Colis.	Prix
							France	Euro 1	Euro 2	Euro 3	Euro 4		
Serrure axe 40mm pêne dormant seul V/BC	00000302	10	-	-	-	-	-	-	-	-	-	-	-
Serrure axe 40mm pêne dormant seul V/BR	00001302	10	-	-	-	-	-	-	-	-	-	-	-
Serrure axe 40mm pêne dormant seul Z/BC	00010302	10	-	-	-	-	-	-	-	-	-	-	-
Serrure axe 40mm pêne dormant seul Z/BR	00011302	10	-	-	-	-	-	-	-	-	-	-	-
Serrure axe 40mm pêne dormant seul V/BR fouillot 6 x 9 mm	00011393	10	-	-	-	-	-	-	-	-	-	-	-
Clé rectangulaire 9 mm	00013926	10	-	-	-	-	-	-	-	-	-	-	-

Tarif conditionnement non décollable

Serrure axe 40mm bec de cane V/BR fouillot 6 x 9 mm epoxy blanc livré sans gâche (50 pièces non décollable)	00052190	50	-	-	-	-	-	-	-	-	-	-	-
Boîtier serrure axe 40mm à cylindre pêne dormant seul V/BR epoxy blanc livré sans gâche (50 pièces non décollable)	00051197	50	-	-	-	-	-	-	-	-	-	-	-

Ⓜ Non stocké/Non-stored/Producto no estocado - Ⓜ Sur stock Europe Zone 1 et Zone 2, nous consulter pour délai d'approvisionnement - Ⓜ Epuisement/Stock depletion/Agotamiento del stock



Axe à 50 mm / PÊNE DORMANT SEUL RESIST



GARANTIE

Caractéristiques certifiées NF :
endurance, durabilité, sécurité.



Spécifications dimensionnelles
selon la norme NF P 26-414

Essais selon la norme NF

EN 12209

Classification

3 S 4 0 0 G 3 H C 0 0

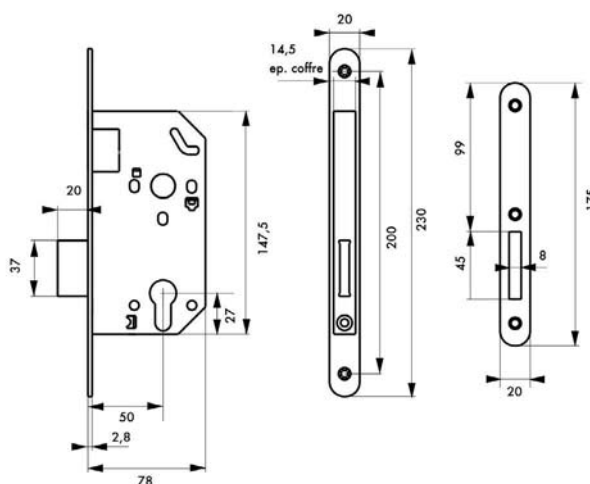

Description/Description/Descripción

Coffre acier embouti. Têtière acier bouts ronds. Pêne dormant acier zingué. Gâche plate acier zingué.
Stamped steel case. Steel forend. Zinc plated steel bolt. Steel flat striker.

Caja de acero embutido. Cabeza de acero. Pestillo de aleación acero. Cerradero plano de acero.

Finition/Finish/Acabado

Coffre galvanisé, têtère epoxy noir granité
Case galvanised, forend black epoxy
Caja galvanizado, cabeza epoxi negro

Version/Option/Versión

Têtère laitonée - Têtère nickelée
Brass plated forend - Nickel plated forend
Cabeza latonado - Cabeza de acero niquelado

Designation	Boite	Colis.	Prix	Sachet	Colis.	Prix	Brochable					Colis.	Prix
							France	Euro 1	Euro 2	Euro 3	Euro 4		
Serrure UNIMAX NF axe 50mm pêne dormant seul têtère noire BR	00015205	5	-	-	-	-	-	-	-	-	-	-	-
Serrure UNIMAX NF axe 50mm pêne dormant seul têtère laitonée BR	00015235	5	-	-	-	-	-	-	-	-	-	-	-
Serrure UNIMAX NF axe 50mm pêne dormant seul têtère nickelée BR	00015225	5	-	-	-	-	-	-	-	-	-	-	-

⚠ Non stocké/Non-stored/Producto no estocado - 📦 Sur stock Europe Zone 1 et Zone 2, nous consulter pour délai d'approvisionnement - 📦 Epuisement/Stock depletion/Agotamiento del stock

Axe à 65 mm / CHAUFFERIE

PROTECT



GARANTIE

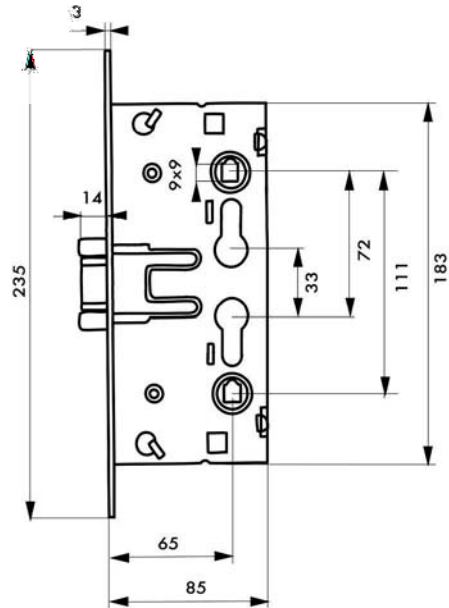

Description/Description/Descripción

Coffre acier zingué. Têtière acier zingué bouts ronds. Réversible. Pêne acier. Carré 9 mm entr'axe 72 mm. Rappel du 1/2 tour par la clé.

Zinc coated steel case. Zinc coated steel forend. Reversible. Steel bolt. Square 9 mm. Draw back of the latch by key.

Caja de acero cincado. Cabeza de acero cincado. Reversible. Pestillo de acero. Cuadrado 9 mm. Reposición de la media vuelta con la llave.

Finition/Finish/Acabado

Zingué
Zinc coated
Cincado

Version/Option/Versión

Spécifique pour serrure antipanique
Specific for panic lock
Específico para cerradura antipánico

Utilisation/Use/Utilización

Porte de chaufferie
Boiler door
Puerta de la caldera

Designation	Boite	Colis.	Prix	Sachet	Colis.	Prix	Brochable					Colis.	Prix
							France	Euro 1	Euro 2	Euro 3	Euro 4		
Serrure de chaufferie axe 65mm entraxe 72mm (version standard)	00001739	1	-	-	-	-	00401739	-	00492332	00494332	-	5	-
Serrure de chaufferie axe 65mm entraxe 72mm (version anti-panique)	00001740	1	-	-	-	-	-	-	-	-	-	-	-
Poignée pour serrure chaufferie	00097101	1	-	-	-	-	-	-	00592335	-	-	5	-

Non stocké/Non-stored/Producto no estocado - Sur stock Europe Zone 1 et Zone 2, nous consulter pour délai d'approvisionnement - Epuement/Stock depletion/Agotamiento del stock

Gâches / SERRURE À ENCASTRER



GARANTIE

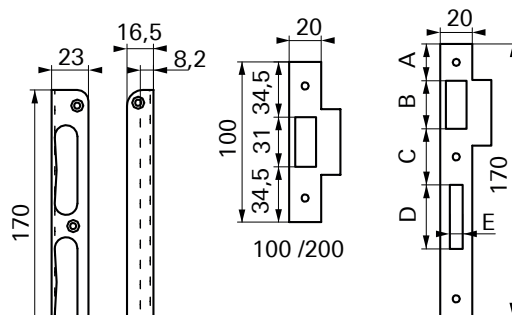

	A	B	C	D	E
102	27,5	30	34,5	40	8
104	23	30	39	40	8
201	25	36	32,5	51	12

Description/Description/Descripción

Acier épaisseur 1,5 mm.

Steel 1,5 mm thickness.

Acero con 1,5 mm de espesor.

Finition/Finish/Acabado

Coffre galvanisé, tête epoxy noir granité

Case galvanised, forend black epoxy

Caja galvanizado, cabeza epoxy negro

Version/Option/Versión

Norme N.F. : épaisseur 1,8 mm.

NF standard : 1,8 mm thickness.

Norma NF: espesor de 1,8 mm

Utilisation/Use/Utilización

Pour serrure à encastrer.

For mortise lock.

Para cerradura a empotrar.

Designation	Boite	Colis.	Prix	Sachet	Colis.	Prix	Brochable					Colis.	Prix
							France	Euro 1	Euro 2	Euro 3	Euro 4		
GACHE universelle sans traîne Z/BR	00001341	50	-	-	-	-	-	-	-	-	-	-	-
GACHE universelle traîne 12 Z/ BR	00001343	50	-	-	-	-	-	-	-	-	-	-	-
GACHE TYPE 100 Traîne 12 grand format BRUT/BR	00001347	50	-	-	-	-	-	-	-	-	-	-	-
GACHE TYPE 100 Traîne 12 grand format Z/BR	00001350	50	-	-	-	-	-	-	-	-	-	-	-
GACHE TYPE 100 Traîne 12 BRUT/BC	00001330	50	-	-	-	-	-	-	-	-	-	-	-
GACHE TYPE 100 Traîne 12 Z/BC	00001530	50	-	-	-	-	-	-	-	-	-	-	-
GACHE TYPE 100 Traîne 12 BRUT/BR	00001340	50	-	-	-	-	-	-	-	-	-	-	-
GACHE TYPE 100 Traîne 12 Z/BR	00001540	50	-	-	-	-	-	-	-	-	-	-	-
GACHE TYPE 100 Traîne 10 BRUT/BR	00041340	50	-	-	-	-	-	-	-	-	-	-	-

Designation	Boite	Colis.	Prix	Sachet	Colis.	Prix	Brochable					Colis.	Prix
							France	Euro 1	Euro 2	Euro 3	Euro 4		
GACHE TYPE 100 Traine 10 Z/BR	00041540	50	-	-	-	-	-	-	-	-	-	-	-
GACHE TYPE 101 - 102 Traine 12 BRUT/BC	00001332	50	-	-	-	-	-	-	-	-	-	-	-
GACHE TYPE 101 - 102 Traine 12 Z/BC	00001532	50	-	-	-	-	-	-	-	-	-	-	-
GACHE TYPE 101 - 102 Traine 12 BRUT/BR	00001342	50	-	-	-	-	-	-	-	-	-	-	-
GACHE TYPE 101 - 102 Traine 12 Z/BR	00001542	50	-	-	-	-	-	-	-	-	-	-	-
GACHE TYPE 101 - 102 Traine 0 BRUT/BR	000011342	50	-	-	-	-	-	-	-	-	-	-	-
GACHE TYPE 101 - 102 Traine 0 Z/BR	000011542	50	-	-	-	-	-	-	-	-	-	-	-
GACHE TYPE 101 - 102 Traine 2 BRUT/BR	00021342	50	-	-	-	-	-	-	-	-	-	-	-
GACHE TYPE 101 - 102 Traine 2 Z/BR	00021542	50	-	-	-	-	-	-	-	-	-	-	-
GACHE TYPE 101 - 102 Traine 3 BRUT/BR	00031342	50	-	-	-	-	-	-	-	-	-	-	-
GACHE TYPE 101 - 102 Traine 3 Z/BR	00031542	50	-	-	-	-	-	-	-	-	-	-	-
GACHE TYPE 101 - 102 F Traine 12 BRUT/BR	00002342	50	-	-	-	-	-	-	-	-	-	-	-
GACHE TYPE 101 - 102 F Traine 12 Z/BR	00002542	50	-	-	-	-	-	-	-	-	-	-	-
GACHE TYPE 101 - 102 F Traine 0 BRUT/BR	00012342	50	-	-	-	-	-	-	-	-	-	-	-
GACHE TYPE 101 - 102 F Traine 0 Z/BR	00012542	50	-	-	-	-	-	-	-	-	-	-	-
GACHE TYPE 101 - 102 F Traine 2 BRUT/BR	00022342	50	-	-	-	-	-	-	-	-	-	-	-
GACHE TYPE 101 - 102 F Traine 2 Z/BR	00022542	50	-	-	-	-	-	-	-	-	-	-	-
GACHE TYPE 101 - 102 L Traine 2 Z/BR	00022642	50	-	-	-	-	-	-	-	-	-	-	-
GACHE TYPE 101 - 102 F Traine 3 Z/BR	00032342	50	-	-	-	-	-	-	-	-	-	-	-
GACHE TYPE 101 - 102 F Traine 3 Z/BR	00032542	50	-	-	-	-	-	-	-	-	-	-	-
GACHE TYPE 101 - 102 F Traine 10 BRUT/BR	00042342	50	-	-	-	-	-	-	-	-	-	-	-
GACHE TYPE 101 - 102 F Traine 10 Z/BR	00042542	50	-	-	-	-	-	-	-	-	-	-	-
GACHE TYPE 104 Traine 12 BRUT/BC	00001334	50	-	-	-	-	-	-	-	-	-	-	-
GACHE TYPE 104 Traine 12Z/BC	00001534	50	-	-	-	-	-	-	-	-	-	-	-
GACHE TYPE 104 Traine 12 BRUT/BR	00001344	50	-	-	-	-	-	-	-	-	-	-	-
GACHE TYPE 104 Traine 12 Z/BR	00001544	50	-	-	-	-	-	-	-	-	-	-	-
GACHE TYPE 200 Traine 12 BRUT/BC	00001335	50	-	-	-	-	-	-	-	-	-	-	-
GACHE TYPE 200 Traine 12 BRUT/BR	00001345	50	-	-	-	-	-	-	-	-	-	-	-
GACHE TYPE 200 Traine 12 Z/BC	00001535	50	-	-	-	-	-	-	-	-	-	-	-
GACHE TYPE 200 Traine 12 Z/BR	00001545	50	-	-	-	-	-	-	-	-	-	-	-



Gâches / SERRURE À ENCASTRER

Designation	Boite	Colis.	Prix	Sachet	Colis.	Prix	Brochable					Colis.	Prix
							France	Euro 1	Euro 2	Euro 3	Euro 4		
GACHE TYPE 201 - 202 - 204 Traine 12 BRUT/BC	00001336	50	-	-	-	-	-	-	-	-	-	-	-
GACHE TYPE 204 Traine 12 Laiton/BC	00001636	50	-	-	-	-	-	-	-	-	-	-	-
GACHE TYPE 204 Traine 12 Laitonnée / BC	00001436	50	-	-	-	-	-	-	-	-	-	-	-
GACHE TYPE 201 - 202 - 204 Traine 12 Z/BC	00001536	50	-	-	-	-	-	-	-	-	-	-	-
GACHE TYPE 201 - 202 - 204 Traine 12 BRUT/BR	00001346	50	-	-	-	-	-	-	-	-	-	-	-
GACHE TYPE 204 Traine 12 Laiton/BR	00001646	50	-	-	-	-	-	-	-	-	-	-	-
GACHE TYPE 204 Laitonnée BR Traine 12	00001446	50	-	-	-	-	-	-	-	-	-	-	-
GACHE TYPE 201 - 202 - 204 Traine 12 Z/BR	00001546	50	-	-	-	-	-	-	-	-	-	-	-
GACHE TYPE 600 Z/BC	00001637	50	-	-	-	-	-	-	-	-	-	-	-
GACHE TYPE 600 Z/BR	00001647	50	-	-	-	-	-	-	-	-	-	-	-
GACHE EQUERRE Z/BR Retour 8	00063542	50	-	-	-	-	-	-	-	-	-	-	-
GACHE EQUERRE Z/BR Retour 16	00073542	50	-	-	-	-	-	-	-	-	-	-	-
GACHE TYPE 101 - 102 BRUT NF	00001333	50	-	-	-	-	-	-	-	-	-	-	-
GACHE TYPE 100 grand format BRUT/BR NF	00001348	50	-	-	-	-	-	-	-	-	-	-	-
TÊTIÈRE DE RÉNOVATION BORGNE 230X20X2,5MM BR Noir	00001390	10	-	-	-	-	-	-	-	-	-	-	-
TÊTIÈRE DE RÉNOVATION BORGNE 230X20X2,5MM BR Inox	00001391	10	-	-	-	-	-	-	-	-	-	-	-



Clé de blocage / POUR SERRURE A ENCASTRER

ECO

Clé de blocage pour empêcher toute introduction contre le crochetage

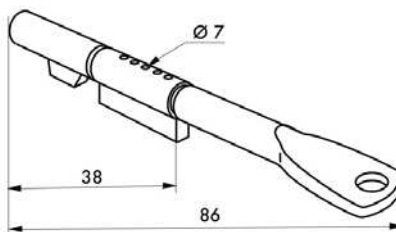

GARANTIE

Description/Description/Descripción

Cylindre à goupilles laiton chromé. Clé acier. Ø 7 mm pour serrure à encastrer axe à 55 mm. Pêne dormant 1/2 tour. Blocage de l'accès de la clé dans la serrure : en tournant la clé 1/4 de tour le cylindre reste dans la serrure. 2 clés.

Chrome plated brass pin cylinder - Steel key. Ø 7 mm for mortise lock with dead bolt 55 mm backset. Locking key entrance in the lock : Turning the key for a quarter turn lets the cylinder in the lock - 2 keys.

Cilindro de pasadores de latón cromado - Llave de acero - Ø 7 mm para cerradura a empotrar, eje a 55 mm Pestillo durmiente de media vuelta Bloqueo del acceso de la llave

en la cerradura: girando la llave un cuarto de vuelta, el cilindro permanece en la cerradura - 2 llaves.

Finition/Finish/Acabado

Nickelé
Nickel plated
Niquelado

Utilisation/Use/Utilización

Empêche l'introduction de la clé. Protection contre le crochetage.

Prevent from the use of the key. Antipicking system.

Impide la introducción de la llave. Protección contra el forzamiento.

Designation	Boite	Colis.	Prix	Sachet	Colis.	Prix	Brochable					Colis.	Prix
							France	Euro 1	Euro 2	Euro 3	Euro 4		
Clé de blocage pour serrure à encastrer	00096770	10	-	-	-	-	00196770	-	-	-	-	10	-

Accessoires / CLE MULTIFONCTIONS

ECO

Clé multifonction de chantier



GARANTIE

Description/Description/Descripción

Clé multifonction alliage. Permet de mesurer le cylindre de 22 à 75mm. Fonction panneton de cylindre DIN. Carré conique de 7 à 10mm. Embout 6 pans Allen 3mm. Carré femelle de 6/7/8mm. Décapsuleur.

Multifunction alloy key. Used to measure cylinders from 22 to 75mm. DIN cam cylinder function. Conical shape square from 7 to 10 mm. 3mm Allen fitting with 6 faces. Square socket of 6/7/8mm. Cap lifter.

Llave multifunción de aleación. Permite medir un cilindro desde 22 a 75mm. Función leva de cilindro DIN. Cuadrado conico de 7 a 10mm. Punto con 6 lados Allen 3mm. Cuadradillo de 6/7/8mm. Destaponador

Finition/Finish/Acabado

Zingué
Zinc coated
Cincado

Designation	Boite	Colis.	Prix	Sachet	Colis.	Prix	Brochable					Colis.	Prix
							France	Euro 1	Euro 2	Euro 3	Euro 4		
Clé multifonction	00098006	1	-	-	-	-	-	-	-	-	-	-	-

⚠ Non stocké/Non-stored/Producto no estocado - 📦 Sur stock Europe Zone 1 et Zone 2, nous consulter pour délai d'approvisionnement - ⚠ Epuement/Stock depletion/Agotamiento del stock

Adaptateur / POUR SERRURE À ENCASTRER

ECO

Adaptateur permettant de faire fonctionner un coffre de serrure à profil européen en fonction «à condamnation»

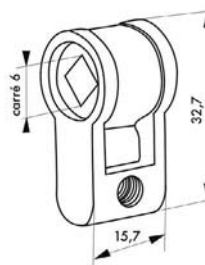

GARANTIE

Description/Description/Descripción

Corps alliage moulé. Carré 6 mm. Livré avec vis.
Moulded alloy body. Square 6 mm. Supplied with screws
Cuerpo de aleación. Cuadrado 6 mm. Entregada con tornillos

Finition/Finish/Acabado

Zingué
Zinc plated
Cincado

Version/Option/Versión

A clé (1 variure).
With key (1 key differ).
Con llave (1 perfil de llave).

Designation	Boite	Colis.	Prix	Sachet	Colis.	Prix	Brochable					Colis.	Prix
							France	Euro 1	Euro 2	Euro 3	Euro 4		
Adaptateur à condamnation	-	-	-	00996771	10	-	-	-	-	-	-	-	-

Adaptateur / POUR SERRURE À ENCASTRER

ECO

Adaptateur permettant de faire fonctionner un coffre de serrure à profil européen en fonction «à clé»



GARANTIE

Description/Description/Descripción

Corps alliage moulé. Livré avec vis.
Moulded alloy body. Supplied with screws
Cuerpo de aleación. Entregada con tornillos

Finition/Finish/Acabado

Zingué
Zinc plated
Cincado

Version/Option/Versión

A clé (1 variure).
With key (1 key differ).
Con llave (1 perfil de llave).

Designation	Boite	Colis.	Prix	Sachet	Colis.	Prix	Brochable					Colis.	Prix
							France	Euro 1	Euro 2	Euro 3	Euro 4		
Adaptateur à clé - 1 clé	-	-	-	00996772	10	-	-	-	-	-	-	-	-

Axe à 40 / 50 mm / FERRURES DE DÉPANNAGE

ECO

Permet la fermeture provisoire de votre porte d'entrée



GARANTIE

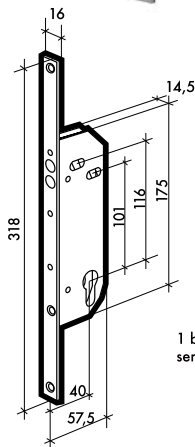

Pêne pour ferrure
Réf. 013958

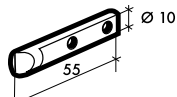

Pêne pour ferrures :
Réf. 097034
Réf. 097006
Réf. 097001
Réf. 013955
Réf. 013986

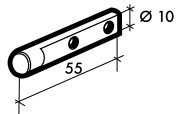

1 bloc serrure

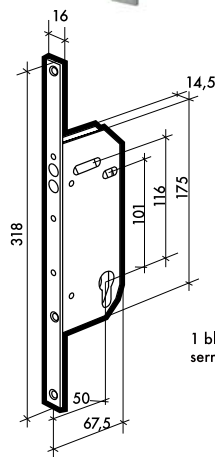

Pêne pour ferrure
Réf. 013959

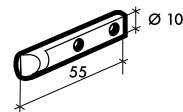

Pêne pour ferrures :
Réf. 097035
Réf. 097007
Réf. 097002
Réf. 013957

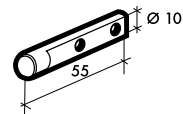

1 bloc serrure



1 vis de fixation des pènes

Description

Coffre en acier épaisseur 14.5 mm. 2 pènes rond rectiligne en acier. Réversible. Pour cylindre profilé européen. Pas de fouillot, manoeuvre de la serrure uniquement par la clé. Existe en axe 40 et 50 mm. Têtière acier galvanisé. Livré sans gâche.

Utilisation

Axe à 40 mm compatible avec les ferrures :Réf. 097034 / 097006 / 097001 / 013958 / 013955 / 013986
Axe à 50 mm compatible avec les ferrures :Réf. 097035 / 097007 / 097002 / 013959 / 013957

Designation	Boite	Colis.	Prix	Sachet	Colis.	Prix	Brochable				Colis.	Prix	
							France	Euro 1	Euro 2	Euro 3			Euro 4
Ferrure de dépannage ferrure axe 40 mm	-	-	-	00913994	10	-	00413994	-	-	-	-	10	-
Ferrure de dépannage ferrure axe 50 mm	-	-	-	00913995	10	-	00413995	-	-	-	-	10	-

Non stocké/Non-stored/Productos no estocados - Sur stock Europe Zone 1 et Zone 2, nous consulter pour délai d'approvisionnement - Epuement/Stock depletion/Agotamiento del stock

CHOISISSEZ VOTRE MODÈLE POUR PORTE D'ENTRÉE

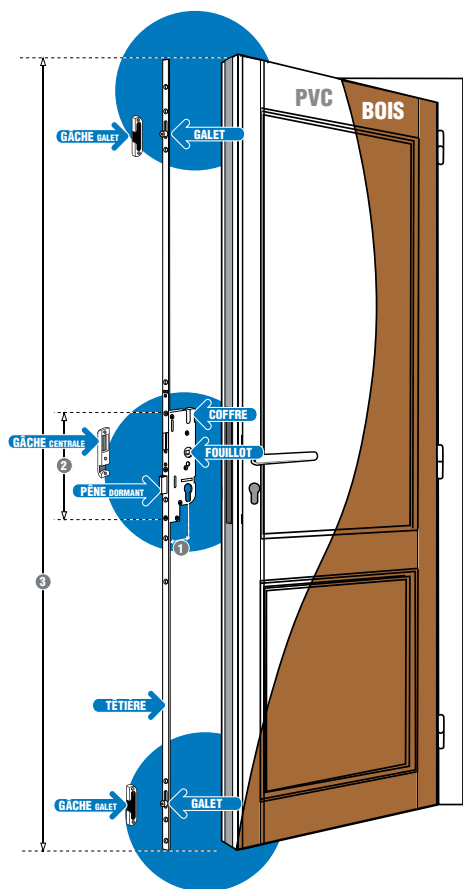

	DECENA	TRIMATIC	EUROPA	FERCOMATIC	SECURY
Référence	097034 • 097035	097006 • 097007	013954 • 097001 • 097002 097026	013958 • 013959 097044 • 097045	013955 • 013957 • 013986 013987 • 013989 • 013996 013997
Type de porte	Bois	Bois	Bois et Pvc	Bois et Pvc	Bois et Pvc
Type de fermeture	Relevage de la poignée	Automatique par déclencheur + relevage de poignée	Relevage de la poignée	Automatique par déclencheur + relevage de poignée	Sans relevage de la poignée pour porte équipée de poignée palière
Largeur de la têtère	18 mm	18 mm	16 mm - 18 mm	16 mm - 18 mm	16 mm - 18 mm
Axe du fouillot (1)	Axe 40 • Axe 50	Axe 40 • Axe 50	Axe 35 • Axe 40 • Axe 50	Axe 40 • Axe 50	Axe 35 • Axe 40 Axe 50 • Axe 55
Hauteur de coffre (2)	173 mm	222 mm	215 mm	183 mm	185 mm
Longueur de crémonne (3)	1522 mm + 2 prolongateurs de 423 mm	1522 mm + 2 prolongateurs de 423 mm	2150 mm - 2285 mm		2150 mm - 2285 mm
Hauteur réglable	Oui	Oui	Non	Oui	Oui
Nbre de point de fermeture	2	2	2 • 4	2 • 4	2 • 4
Pêne dormant	Non	Oui	Oui	Oui	Oui

⚠ Non stocké/Non-stored/Producto no estocado - 📦 Sur stock Europe Zone 1 et Zone 2, nous consulter pour délai d'approvisionnement - 📦 Epuisement/Stock depletion/Agotamiento del stock

CHOISISSEZ VOTRE MODÈLE



POUR PORTE FENÊTRE et FENÊTRE

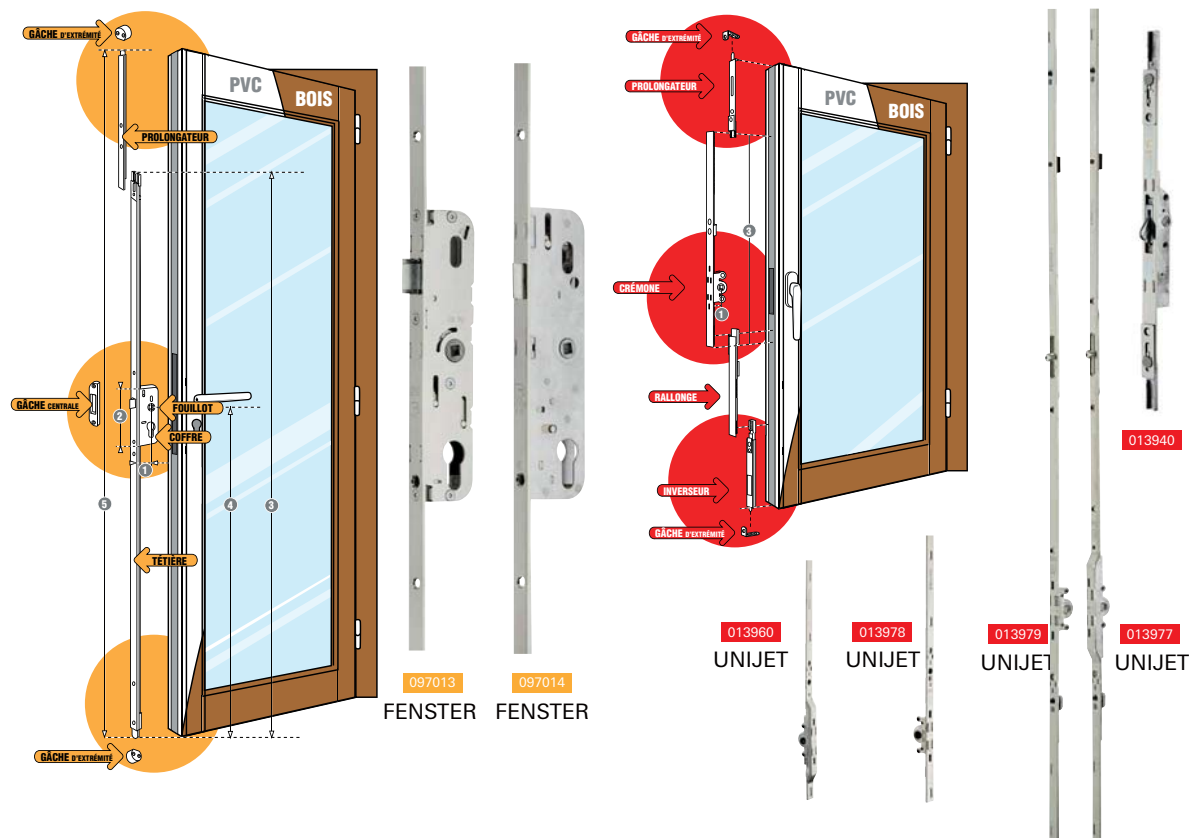
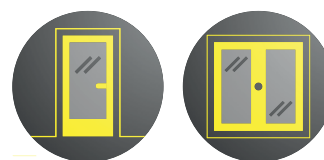

	FENSTER H. 980 mm	FENSTER H. 1028 mm	UNIJET H. 400 mm	UNIJET H. 1280 mm	Crémone à panneton
Référence	013990 • 097013 097003 • 013991	097004 • 097014	013978 • 013960	013977 • 013979	013940
Type de fenêtre porte fenêtre	Bois et Pvc				Bois
Type de fermeture	Relevage de la poignée	Relevage de la poignée	-	-	-
Largeur de la tète	16 mm	16 mm	16 mm	16 mm	15 mm
Axe du fouillot (1)	Axe 25 • Axe 28 Axe 35 • Axe 40	Axe 28 • Axe 35	Axe 7,5 • Axe 15	Axe 7,5 • Axe 15	Axe 15
Hauteur de coffre (2)	-	-	-	-	-
Longueur de crémone (3)	1522 mm	1522 mm	400 - 1280 mm	400 - 1280 mm	270 mm
Hauteur réglable	Oui	Oui	Oui	Oui	Oui
Nbre de verrouillage	2	2	2 - 3	2 - 3	3
Pêne dormant	Non	Non	Non	Non	Non
Réf. gâche centrale	077018 (Réversible) 077015 (Droite) 077016 (Gauche) 077017 (gâche galet)	077042 (droite) 077742 (gauche) 077638 (gâche galet)	Pour Réf. 097001 / 097002 077011 (droite) 077013 (gauche)	-	-

Ⓜ Non stocké/Non-stored/Producto no estocado - Ⓜ Sur stock Europe Zone 1 et Zone 2, nous consulter pour délai d'approvisionnement - Ⓜ Epuiseiment/Stock depletion/Agotamiento del stock

Serrure 2 points - DECENA



GARANTIE

Pour porte d'entrée bois

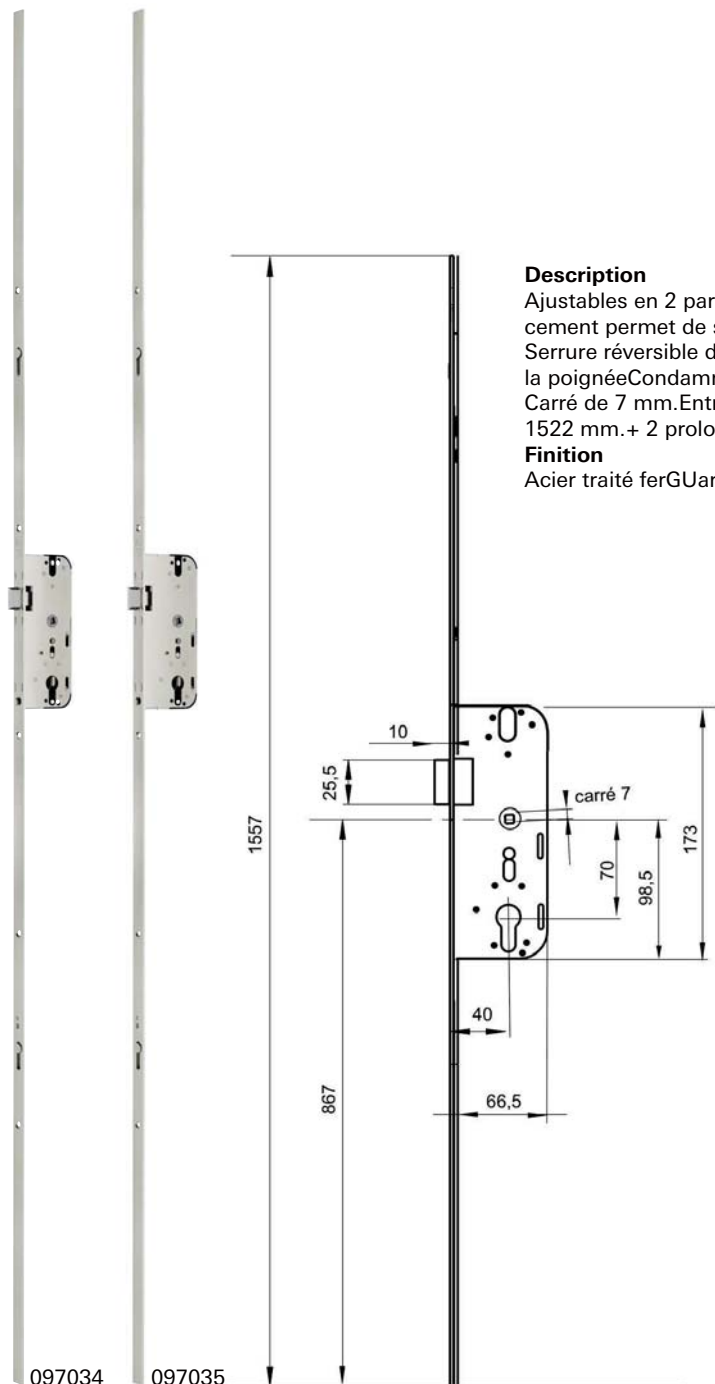

Description

Ajustables en 2 parties. Cette crémone prévue pour le remplacement permet de s'adapter aux entraxes de galets existants. Serrure réversible droite ou gauche Verrouillage par relevage de la poignée Condamnation par cylindre à profil européen Fouillot Carré de 7 mm. Entraxe : 70 mm. Têtière de 18 mm. Longueur 1522 mm. + 2 prolongateurs avec 1 galet de 423 mm

Finition

Acier traité ferGUard argent®



Points de verrouillage



Reversible



Type de verrouillage



Type de porte

Réf. THIRARD	Réf. FERCO	Designation	Axe	Hauteur	Colis	Prix
00097034	G-18294-00-0-1	Serrure à encastrer DECENA + 2 prolongateurs 423 mm avec 1 galet Têtière 18 mm	40	1522	1	-
00097035	G-18295-00-0-1	Serrure à encastrer DECENA + 2 prolongateurs 423 mm avec 1 galet - Têtière 18 mm	50	1522	1	-

⚠ Non stocké/Non-stored/Producto no estocado - 📦 Sur stock Europe Zone 1 et Zone 2, nous consulter pour délai d'approvisionnement - 📦 Epuisement/Stock depletion/Agotamiento del stock

Serrure 3 points - TRIMATIC



GARANTIE

Pour porte d'entrée bois

Description

Crémone prévue pour le remplacement permet de s'adapter aux entraxes de galets existants. Serrure réversible droite ou gauche. Verrouillage automatique par déclancheur. Condamnation par cylindre à profil européen et relevage de poignée. Fouillot Carré de 7 mm. Entraxe : 70 mm. Tête de 18 mm. + 2 prolongateurs avec 1 galet de longueur 423 mm.

Finition

Acier traité ferGUard argent®

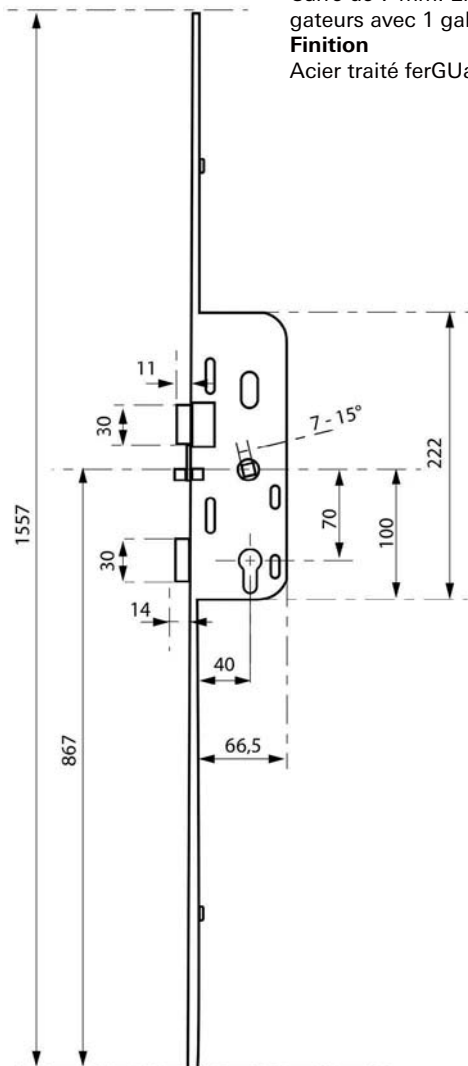

Points de verrouillage

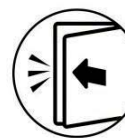

Type de verrouillage



Reversible

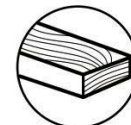

Type de porte



Réf. THIRARD	Réf. FERCO	Designation	Axe	Hauteur	Colis	Prix
00097006	G-18296-00-0-1	Serrure à encastrer TRIMATIC + 2 prolongateurs 423 mm avec 1 galet - Tête de 18 mm	40	1522	1	-
00097007	G-18297-00-0-1	Serrure à encastrer TRIMATIC + 2 prolongateurs 423 mm avec 1 galet - Tête de 18 mm	50	1522	1	-

Non stocké/Non-stored/Producto no estocado - Sur stock Europe Zone 1 et Zone 2, nous consulter pour délai d'approvisionnement - Epuiselement/Stock depletion/Agotamiento del stock



GARANTIE

Pour porte d'entrée bois et pvc

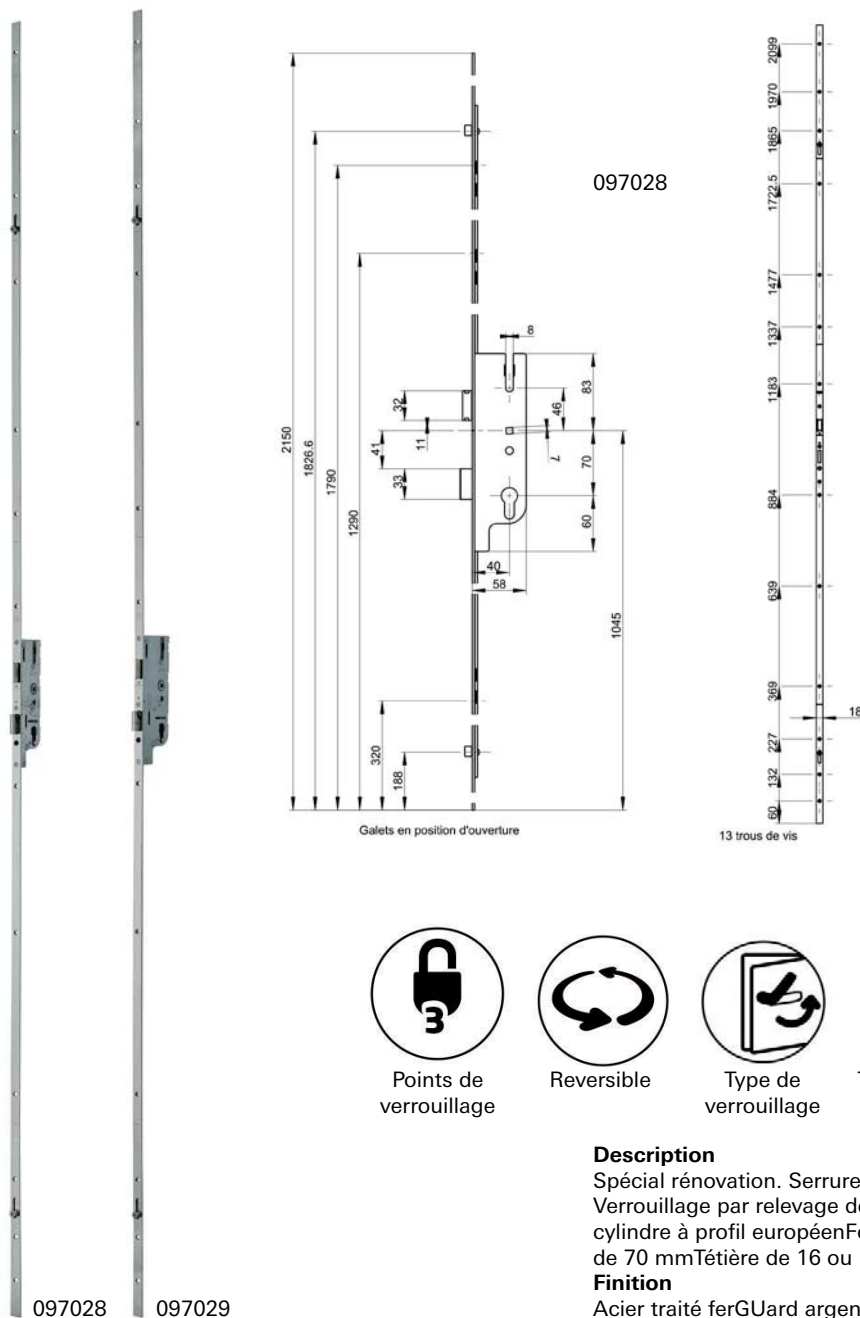

Points de verrouillage



Reversible



Type de verrouillage



Type de porte



Type de porte

Description

Spécial rénovation. Serrure réversible droite ou gauche-Verrouillage par relevage de la poignée.Condamnation par cylindre à profil européenFouillot Carré de 7mmEntraxe de 70 mmTêtière de 16 ou 18 mm.

Finition

Acier traité ferGUard argent®

Réf. THIRARD	Réf. FERCO	Designation	Axe	Hauteur	Colis	Prix
00097028	6-33166-06-0-1	Serrure à encastrer EUROPA R2 - 3 points - Bois Carré de 7 mm - Têtière : 18 mm - Hauteur poignée : H 1045 mm	40	2150	1	-
00097029	6-33166-07-0-1	Serrure à encastrer EUROPA R2 - 3 points - Bois Carré de 7 mm - Têtière : 18 mm - Hauteur poignée : H 1045 mm	50	2150	1	-
00097001	G-18296-00-0-1	Serrure à encastrer EUROPA R2 - 3 points - Bois et pvc carré 7 mm - Têtière 16 mm - Hauteur poignée 1045 mm	40	2150	1	-
00097002	G-18297-00-0-1	Serrure à encastrer EUROPA R2 - 3 points- Bois et pvc carré 7 mm - Têtière 16 mm - Hauteur poignée 1045 mm	50	2150	1	-

Serrure 5 points - EUROPA



GARANTIE

Pour porte d'entrée bois et pvc

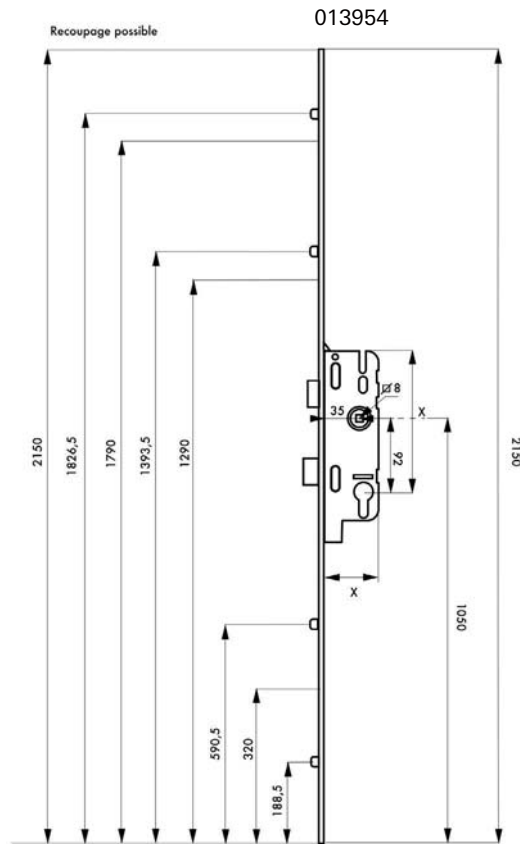

Points de verrouillage



Reversible



Type de verrouillage



Type de porte

Description

Spécial rénovation. Serrure réversible droite ou gauche Verrouillage par relevage de la poignée. Condamnation par cylindre à profil européen Fouillot carré de 7 mm (8mm réf. : 013954) Entraxe de 70 mm (entraxe de 92mm réf. : 013954) Têtière de 16 mm.

Finition

Acier traité ferGUard argent®

Réf. THIRARD	Réf. FERCO	Designation	Axe	Hauteur	Colis	Prix
00013954	6-32580-01-0-1	Serrure à encastrer EUROPA R4 - 5 points carré 8 mm - Têtière 16 mm - Hauteur poignée 1050 mm	35	2285	1	-
00097026	6-33162-01-0-1	Serrure à encastrer EUROPA R4 - 5 points carré 7 mm - Têtière 16 mm - Hauteur poignée 1045 mm	40	2150	1	-
00097027	6-33604-01-0-1	Serrure à encastrer EUROPA R4 - 5 points carré 7 mm - Têtière 16 mm - Hauteur poignée 1045 mm	50	2150	1	-

Non stocké/Non-stored/Producto no estocado - Sur stock Europe Zone 1 et Zone 2, nous consulter pour délai d'approvisionnement - Epuiseiment/Stock depletion/Agotamiento del stock

Serrure 3 points - FERCOMATIC

Pour porte d'entrée bois et pvc



GARANTIE

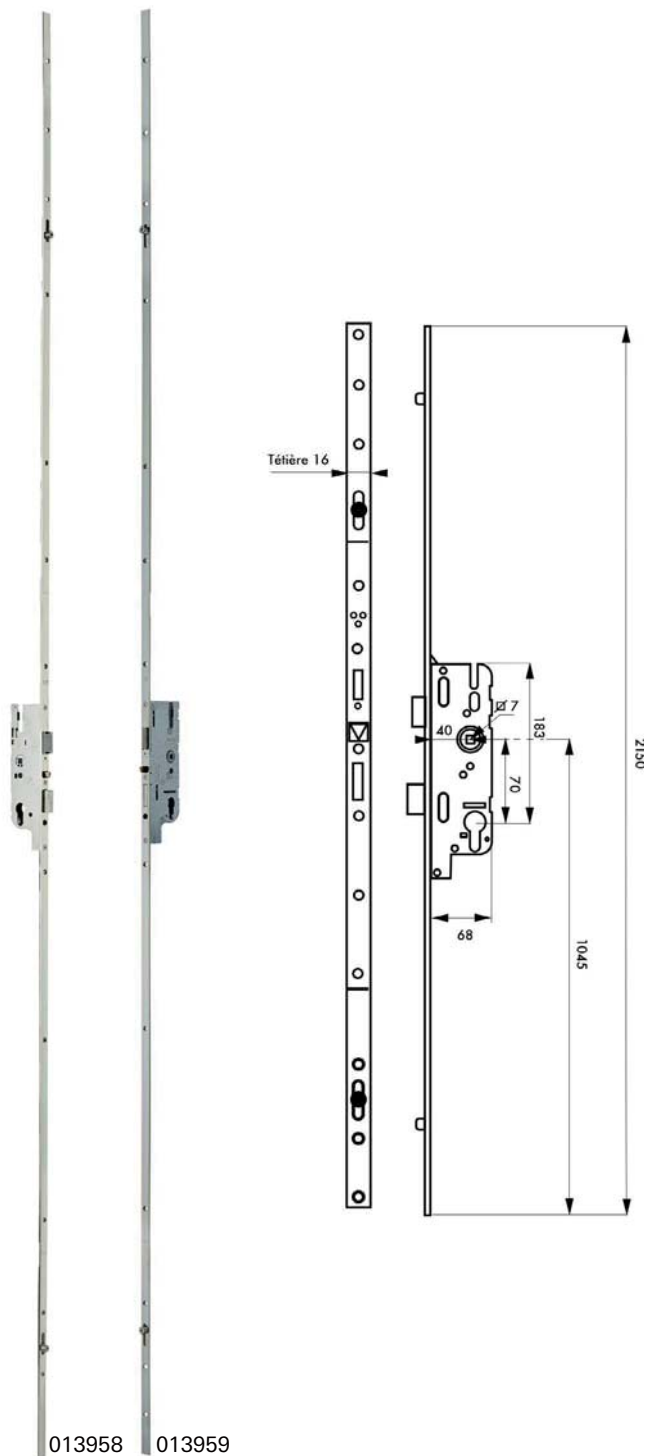

Description

Crémone serrure à déclenchement automatique. Verrouillage par 2 galets, pêne dormant et demi tour. Serrure réversible droite ou gauche. Verrouillage automatique par déclencheur. Condamnation par cylindre à profil européen et relevage de poignée. Fouillot Carré de 7 mm. Entraxe : 70 mm. Têtière de 16 mm.

Finition

Acier traité ferGUard argent®



Points de verrouillage



Type de verrouillage



Réversible



Type de porte

013958 013959

Réf. THIRARD	Réf. FERCO	Designation	Axe	Hauteur	Colis	Prix
00013958	6-33164-03-0-1	Serrure à encastrer FERCOMATIC R2 - 3 points Têtière 16 mm - Hauteur poignée 1045 mm	40	2150	1	-
00013959	6-33164-08-0-1	Serrure à encastrer FERCOMATIC R2 - 3 points Têtière 16 mm - Hauteur poignée 1045 mm	50	2150	1	-

⚠ Non stocké/Non-stored/Producto no estocado - 📦 Sur stock Europe Zone 1 et Zone 2, nous consulter pour délai d'approvisionnement - 📦 Epuisement/Stock depletion/Agotamiento del stock

Serrure 3 points - FERCOMATIC

Pour porte d'entrée bois



GARANTIE

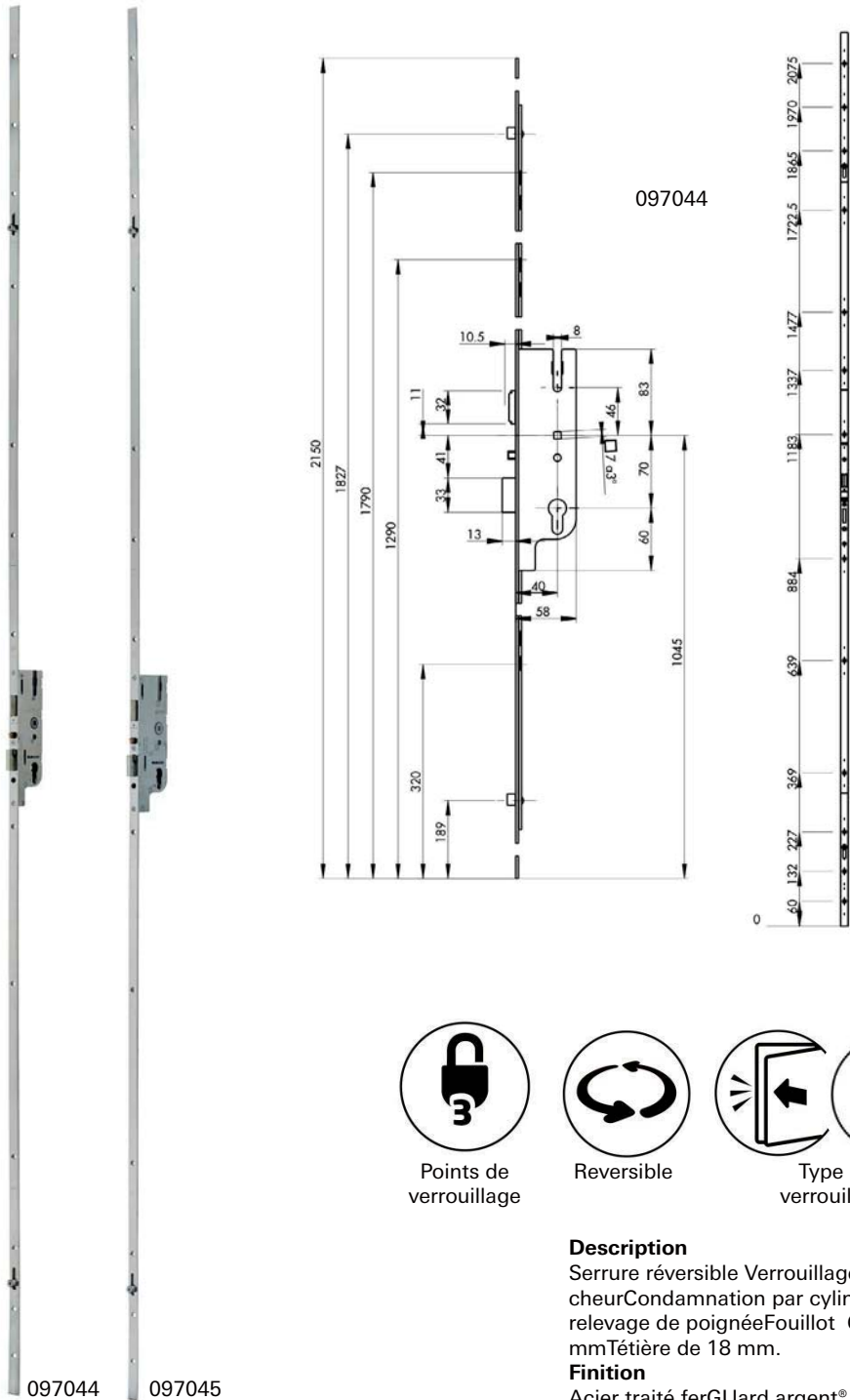

Points de verrouillage



Reversible



Type de verrouillage



Type de porte

Description

Serrure réversible Verrouillage automatique par déclencheur
 Condamnation par cylindre à profil européen
 relevage de poignée
 Fouillot Carré de 7mm
 Entraxe de 70 mm
 Tête de 18 mm.

Finition

Acier traité ferGUard argent®

Réf. THIRARD	Réf. FERCO	Designation	Axe	Hauteur	Colis	Prix
00097044	6-33164-11-0-1	Serrure à encastrer FERCOMATIC R2 - 3 points Carré de 7 mm - Tête de 18 mm - Hauteur poignée : H 1045 mm	40	2150	1	-
00097045	6-33164-12-0-1	Serrure à encastrer FERCOMATIC R2 - 3 points Carré de 7 mm - Tête de 18 mm - Hauteur poignée : H 1045 mm	50	2150	1	-

Non stocké/Non-stored/Productos no estocados - Sur stock Europe Zone 1 et Zone 2, nous consulter pour délai d'approvisionnement - Epuiseamiento/Stock depletion/Agotamiento del stock



GARANTIE



097041

097042

097043

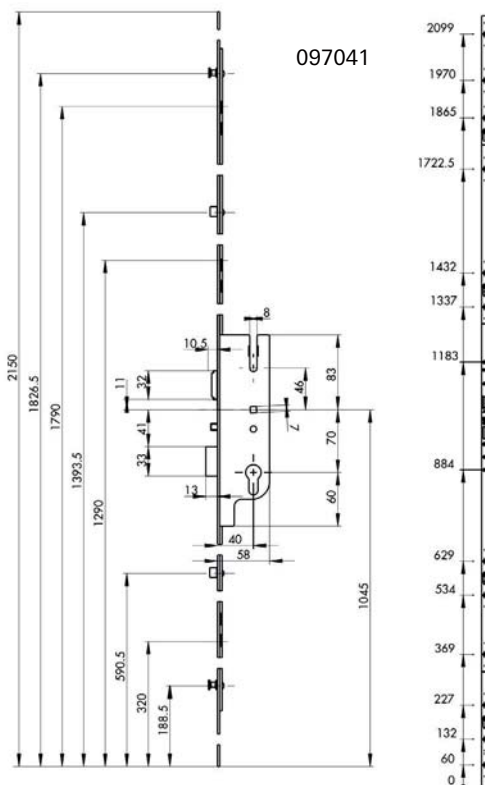

097041



Points de verrouillage



Reversible



Type de verrouillage



Type de porte

Description

Serrure réversible Verrouillage automatique par déclencheur Verrouillage :

097041 : 2 galets + 2 galets tête champignon
 pènes dormat et demi tour

097042 : 4 galets
 pènes dormat et demi tour

097043 : 2 galets + 2 crochets
 pènes dormat et demi tour
 Condamnation par cylindre à profil européen et relevage de poignée
 Fouillot Carré de 7 mm
 Entraxe de 70 mm
 Têtière de 16 mm.

Finition

Acier traité ferGUard argent®

Réf. THIRARD	Réf. FERCO	Designation	Axe	Hauteur	Colis	Prix
00097041	6-33178-01-0-1	Serrure à encastrer FERCOMATIC R4 (2 galets tête champignon) 5 points Carré de 7 mm - Têtière : 16 mm - Hauteur poignée : H 1045 mm	40	2150	1	-
00097042	6-33160-06-0-1	Serrure à encastrer FERCOMATIC R4 - 5 points Carré de 7 mm - Têtière : 16 mm - Hauteur poignée : H 1045 mm	50	2150	1	-
00097043	6-33182-01-0-1	Serrure à encastrer FERCOMATIC R4 (2 crochets) - 5 points Carré de 7 mm - Têtière : 16 mm - Hauteur poignée : H 1045 mm	40	2150	1	-

Serrure 5 points - FERCOMATIC

Pour porte d'entrée bois et pvc



GARANTIE

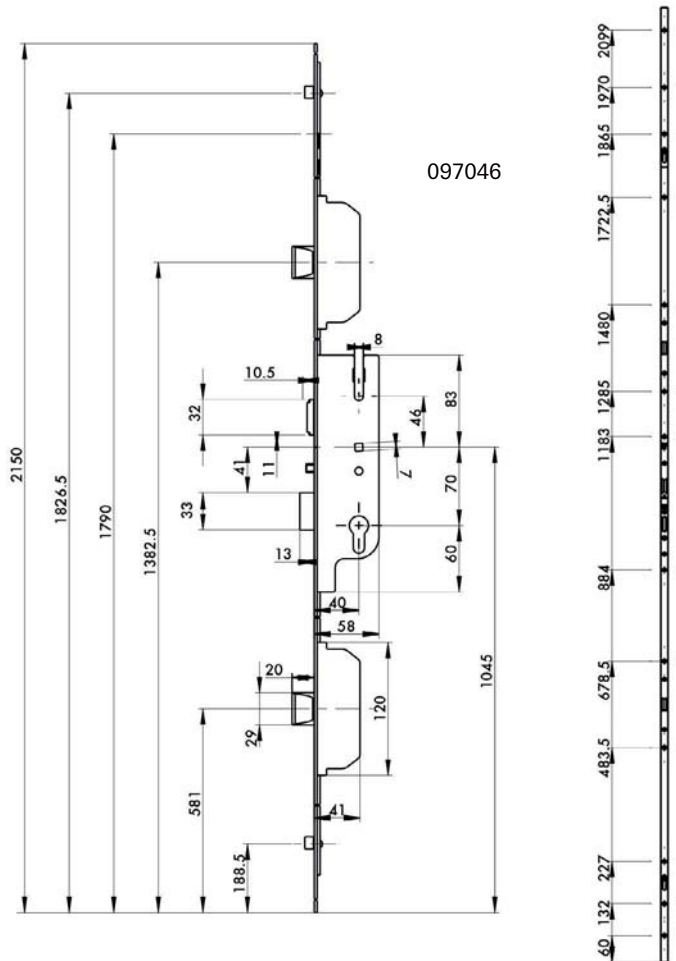

Points de verrouillage



Reversible

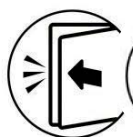

Type de verrouillage



Type de porte

Description

Serrure réversible Verrouillage automatique par déclencheur
 Verrouillage :097046 : 2 galets + 3 pêne latéraux
 097047 : 2 galets + 3 pêne latéraux
 Condamnation par cylindre à profil européen et relevage de poignée-
 Fouillot Carré de 7mm Entraxe de 70 mm Têtière de 16 mm.

Finition

Acier traité ferGUard argent®

Réf. THIRARD	Réf. FERCO	Designation	Axe	Hauteur	Colis	Prix
00097046	6-33174-01-0-1	Serrure à encastrer FERCOMATIC R4 (3 pêne latéraux) - 5 points Carré de 7 mm - Têtière : 16 mm - Hauteur poignée : H 1045 mm	40	2150	1	-
00097047	6-33174-02-0-1	Serrure à encastrer FERCOMATIC R4 (3 pêne latéraux) - 5 points Carré de 7 mm - Têtière : 16 mm - Hauteur poignée : H 1045 mm	50	2150	1	-

Non stocké/Non-stored/Producto no estocado - Sur stock Europe Zone 1 et Zone 2, nous consulter pour délai d'approvisionnement - Epuement/Stock depletion/Agotamiento del stock

Serrure 3 points - SECURY



Pour porte d'entrée bois et pvc



GARANTIE



013996

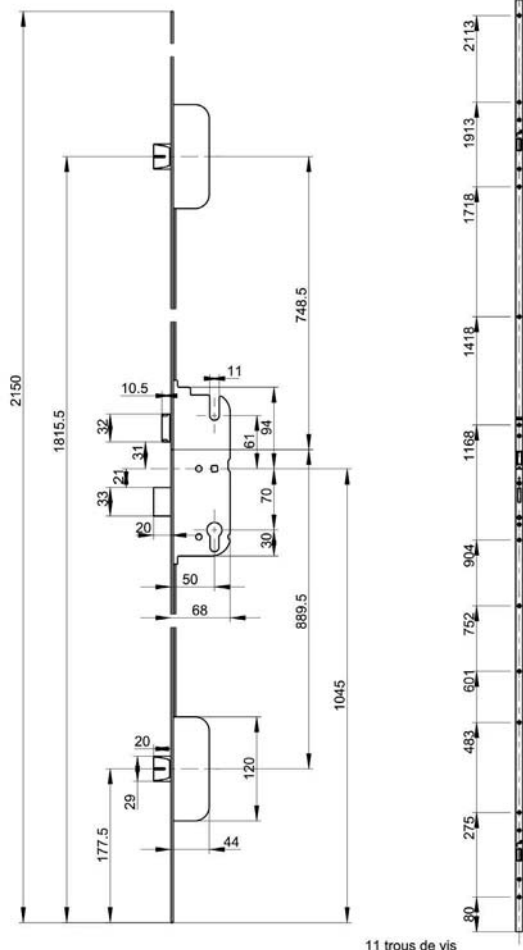

11 trous de vis



Points de verrouillage



Reversible



Type de verrouillage



Type de verrouillage

Description

Serrure réversible droite ou gauche pour porte équipée de poignée de tirage extérieure
Condamnation par cylindre à profil européen
3 points de verrouillage : Têtière de 16 mm.
Convient pour porte équipée de poignée de tirage extérieur

Finition

Acier traité ferGUard argent®

Réf. THIRARD	Réf. FERCO	Designation	Axe	Hauteur	Colis	Prix
00013996	6-29175-01-01	Serrure à encastrer SECURY R2 - 3 points latéraux - Bois et pvc Carré de 7 mm - Têtière : 16 mm - Hauteur poignée : H 1045 mm	50	2150	1	-

Non stocké/Non-stored/Producto no estocado - Sur stock Europe Zone 1 et Zone 2, nous consulter pour délai d'approvisionnement - Epuisement/Stock depletion/Agotamiento del stock

Serrure 5 points - SECURITY



Pour porte d'entrée bois et pvc



GARANTIE

013955

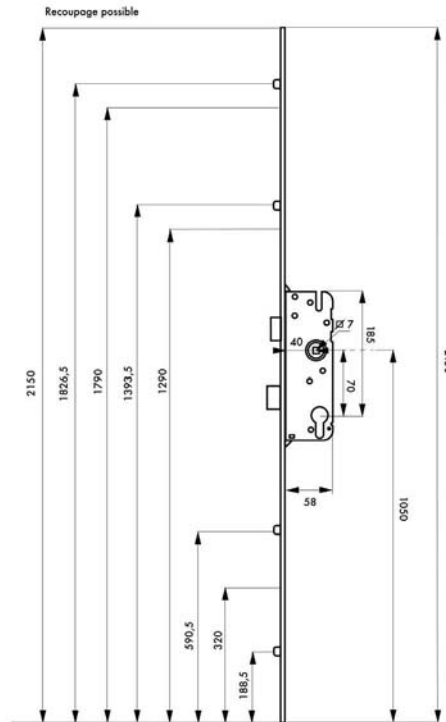

Points de verrouillage



Reversible



Type de verrouillage



Type de verrouillage



Description

Serrure réversible droite ou gauche pour porte équipée de poignée de tirage extérieure. Condamnation par cylindre à profil européen. 5 points de verrouillage : pêne central + 4 galets. Têtière de 16 mm. Convient pour porte équipée de poignée de tirage extérieur.

Finition

Acier traité ferGUard argent®

013955 013957 013986 013987

Réf. THIRARD	Réf. FERCO	Designation	Axe	Hauteur	Colis	Prix
00013955	G-20770-21-0-1	Serrure à encastrer SECURITY R4- 5 points - carré de 7 / EA 70 Têtière 16 mm - Hauteur poignée 1050 mm	40	2150	1	-
00013957	6-31998-17-0-1	Serrure à encastrer SECURITY R4- 5 points - carré de 7 / EA 70 Têtière 16 mm - Hauteur poignée 1045 mm	50	2150	1	-
00013986	6-26460-01-0-1	Serrure à encastrer SECURITY R4- 5 points - carré de 8 / EA 92 Têtière 16 mm - Hauteur poignée 1050 mm	40	2285	1	-
00013987	6-26463-01-0-1	Serrure à encastrer SECURITY R4- 5 points - carré de 8 / EA 92 Têtière 16 mm - Hauteur poignée 1050 mm	55	2285	1	-

Non stocké/Non-stored/Productos no estocados - Sur stock Europe Zone 1 et Zone 2, nous consulter pour délai d'approvisionnement - Epuiseamiento/Stock depletion/Agotamiento del stock

Serrure 2 points - FENSTER



GARANTIE

Pour porte d'entrée bois et pvc



013990 097013 097003

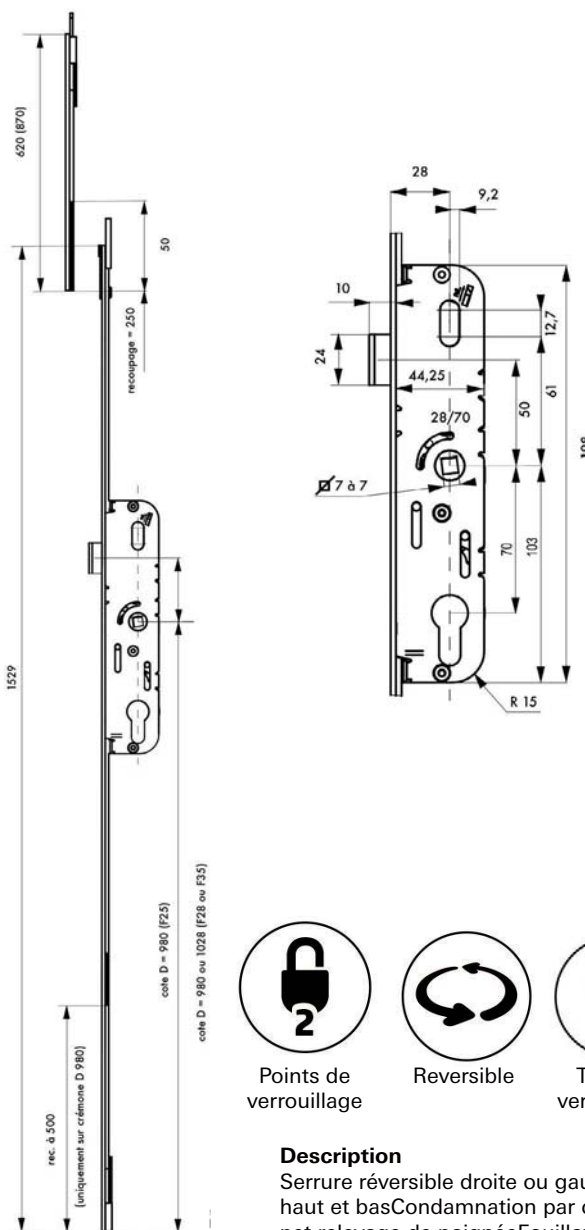

Points de verrouillage



Reversible



Type de verrouillage



Type de porte

Description

Serrure réversible droite ou gauche Verrouillage par pêne haut et bas Condamnation par cylindre à profil européen relevage de poignée Fouillot Carré de 7 mm. Entraxe : 70 mm Têtière de 16 mm.

Finition

Acier traité ferGUard argent®

Réf. THIRARD	Réf. FERCO	Designation	Axe	Hauteur	Colis	Prix
00013990	G-21266-18-L1	Serrure à encastrer FENSTER Têtière 16 mm - Hauteur poignée 980 mm	25	1530	1	-
00097013	G-22682-15-0-1	Serrure à encastrer FENSTER Têtière 16 mm - Hauteur poignée 980 mm	28	1530	1	-
00097003	G-22782-15-0-1	Serrure à encastrer FENSTER Têtière 16 mm - Hauteur poignée 980 mm	35	1530	1	-
00013991	G-22763-18-L1	Serrure à encastrer FENSTER Têtière 16 mm - Hauteur poignée 980 mm	40	1530	1	-
00097004	G-22682-45-0-1	Serrure à encastrer FENSTER Têtière 16 mm - Hauteur poignée 1028 mm	28	1530	1	-
00097014	G-22782-45-0-1	Serrure à encastrer FENSTER Têtière 16 mm - Hauteur poignée 1028 mm	35	1530	1	-

Non stocké/Non-stored/Producto no estocado - Sur stock Europe Zone 1 et Zone 2, nous consulter pour délai d'approvisionnement - Epuisement/Stock depletion/Agotamiento del stock



Pour porte d'entrée bois et pvc



GARANTIE

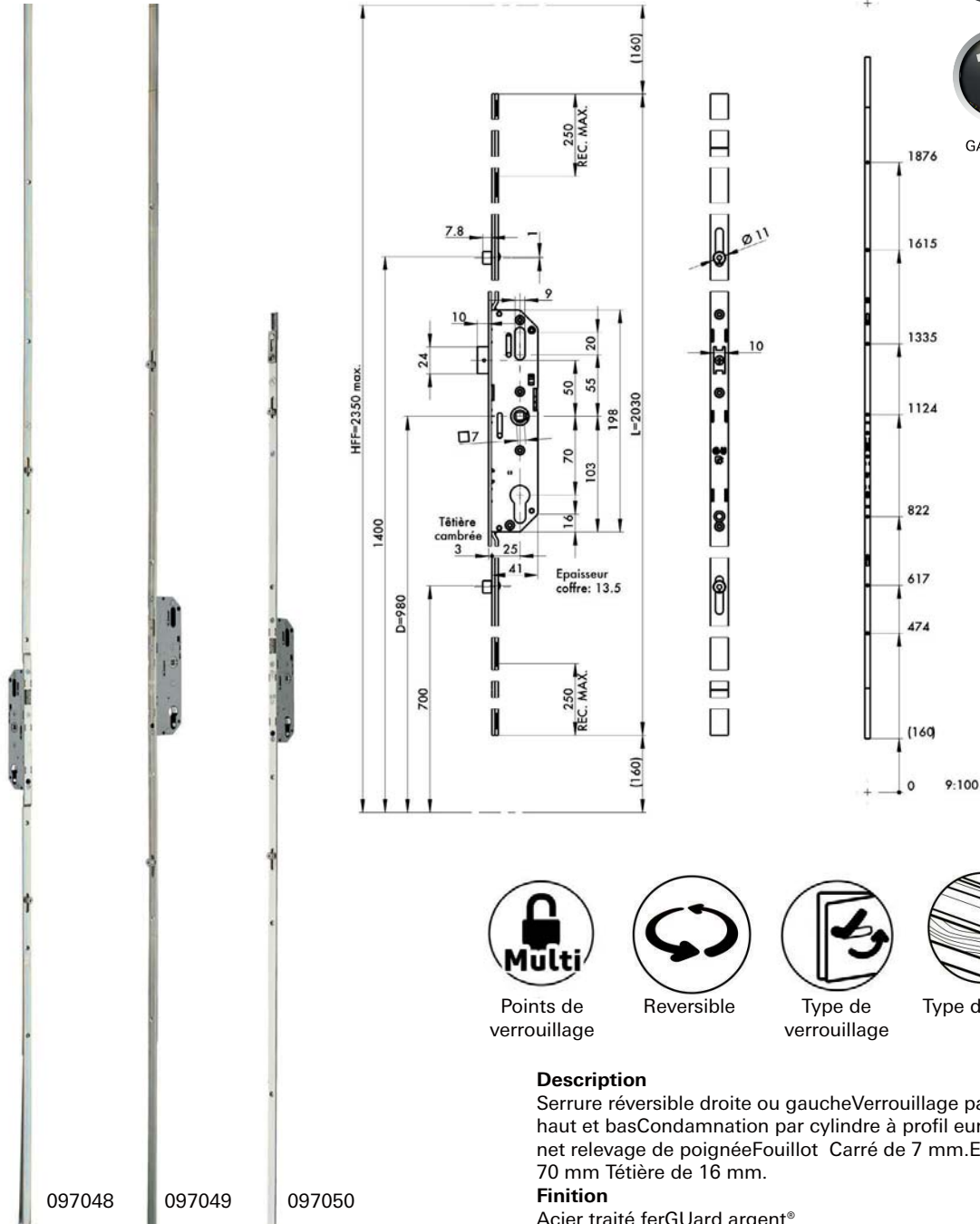

Points de verrouillage



Reversible



Type de verrouillage



Type de porte

Description

Serrure réversible droite ou gauche
Verrouillage par pêne haut et bas
Condamnation par cylindre à profil européen
relevage de poignée Fouillot Carré de 7 mm.
Entraxe : 70 mm
Tête de 16 mm.

Finition

Acier traité ferGUard argent®

Réf. THIRARD	Réf. FERCO	Designation	Axe	Hauteur	Colis	Prix
00097048	G-21266-20-L1	Serrure à encastrer FENSTER Tête 16 mm - Hauteur poignée 730 à 980 mm*	25	2030	1	-
00097050	6-33160-06-0-1	Serrure à encastrer FENSTER Tête 16 mm - Hauteur poignée 730 à 980 mm*	28	1529	1	-
00097049	G-22777-18-L1	Serrure à encastrer FENSTER Tête 16 mm - Hauteur poignée 730 à 980 mm*	35	1780	1	-



GARANTIE

Pour fenêtre bois - pvc ouvrant à la française

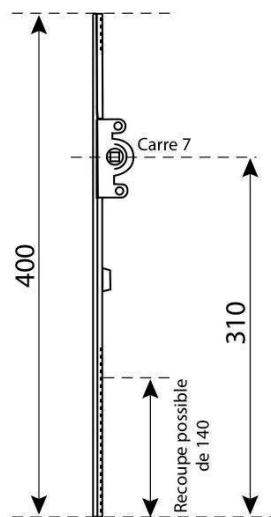

Description

Crémone pour fenêtre ouvrant à la française Crémone réversible droite ou gauche Fouillot Carré de 7 mm. Tête de 16 mm.

Finition

Acier traité ferGUard argent®

Réf. THIRARD	Réf. FERCO	Designation	Axe	Hauteur	Colis	Prix
00013978	G-2204C-00-0-1	UNIJET CREMONE Ouvrant à la française Dimensions : H 400 mm - Pour tête : 16 mm	15		1	-
00013979	G-22044-00-0-1	UNIJET CREMONE Ouvrant à la française Dimensions : Long. 1280 mm - Pour tête : 16 mm Recoupe bas : 150 mm - Recoupe haut : 250 mm	15		1	-
00013960	G-22060-00-0-1	UNIJET CREMONE Ouvrant à la française Dimensions : H 400 mm - Pour tête : 16 mm	7.5		1	-
00013977	G-22064-00-0-1	UNIJET CREMONE Ouvrant à la française Dimensions : Long. 1280 mm - Pour tête : 16 mm Recoupe bas : 150 mm - Recoupe haut : 250 mm	7.5		1	-

⚠ Non stocké/Non-stored/Producto no estocado - 📦 Sur stock Europe Zone 1 et Zone 2, nous consulter pour délai d'approvisionnement - 📦 Epuisement/Stock depletion/Agotamiento del stock



GARANTIE

Pour fenêtre bois

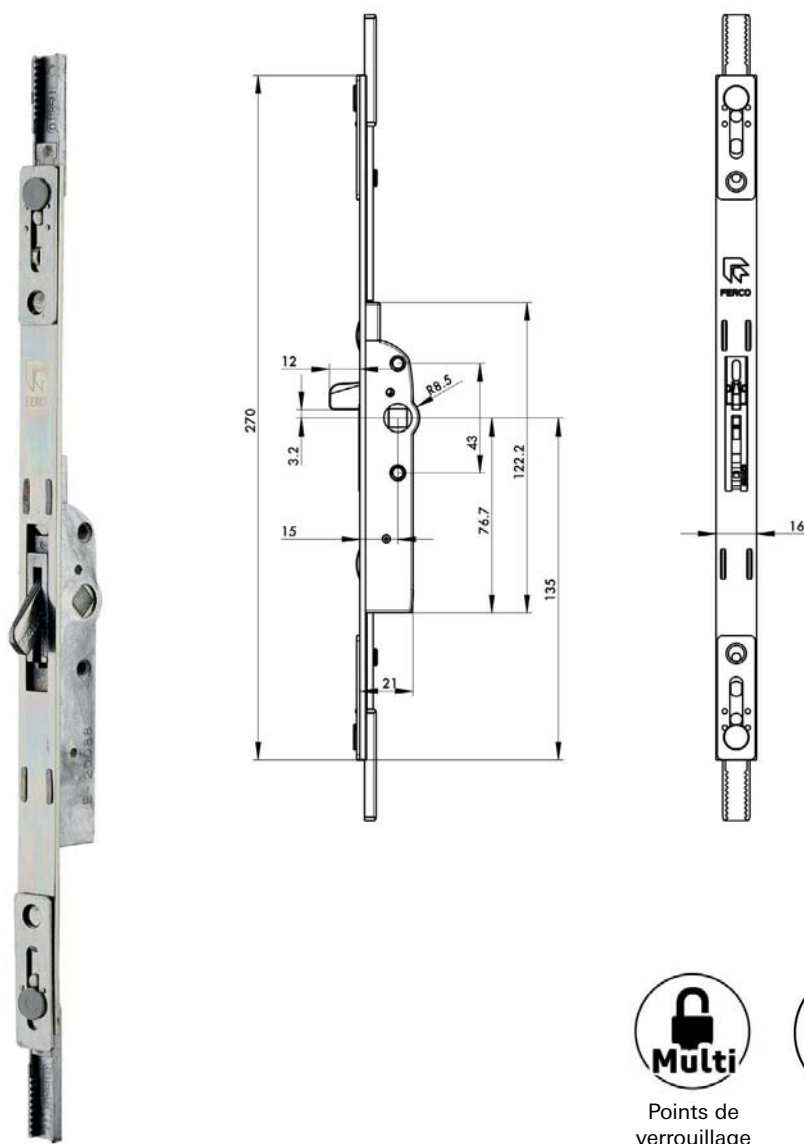

013940



Points de verrouillage



Reversible



Type de verrouillage

Description

Crémone pour fenêtre ouvrant à la française Crémone réversible droite ou gauche Fouillot Carré de 7 mm. Tête de 16 mm.

Finition

Acier traité ferGUard argent®

Réf. THIRARD	Réf. FERCO	Designation	Axe	Hauteur	Colis	Prix
00013940	G-20396-00-0-1	UNIJET CREMONE à panneton - Ouvrant à la française Dimensions : H 270 mm - Pour tête : 16 mm	15		1	-

Pour fenêtre bois



GARANTIE



097009



097019



097020



077024

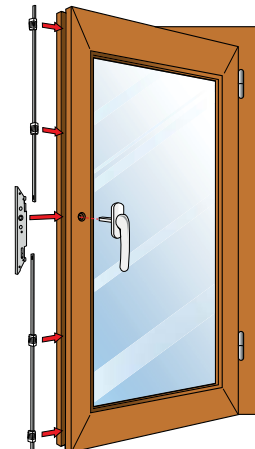
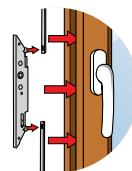
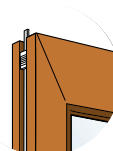
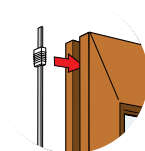

097033



Points de verrouillage



Reversible



Type de verrouillage

Description

Crémone pour fenêtre ouvrant à la française Crémone réversible droite ou gauche Fouillot Carré de 7 mm - Tête de 16 mm.

Finition

Acier traité ferGUard argent®







Réf. THIRARD	Réf. FERCO	Designation	Axe	Hauteur	Colis	Prix
00077024	0-6180-00-0-0	Guide tringle x 2 - pour crémone			15	-
00097033	0-6137-18-0-11	Tringle à lumière Dimensions : H 1850 mm			1	-
00097009	A-00776-00-0-1	Crémone à encastrer Axe : 10 mm - Carré : 7 mm Dimensions : 150 x 27 mm - Tête : H 180 x 10 mm			10	-
00097019	A-06120-00-0-1	Crémone à encastrer Axe : 10 mm - Carré : 7 mm Dimensions : H 203 x 30 mm			10	-
00097020	A-06140-00-0-1	Crémone à encastrer avec panneton Axe : 10 mm - Carré : 7 mm Dimensions : H 203 x 30 mm			10	-

Pour porte d'entrée bois

	Réf. THIRARD	Réf. FERCO	Designation	Axe	Hauteur	Colis	Prix
	00013968	G-22893-00-R-1	Gâche centrale à encastrer Droite - Bois Compatible avec la serrure : FERCOMATIC Dimensions : 188 x 14 x 15 mm			10	-
	00013969	G-22893-00-L-1	Gâche centrale à encastrer Gauche - Bois Compatible avec la serrure : FERCOMATIC Dimensions : 188 x 14 x 15 mm			10	-
	00013973	G-22826-01-R-1	Gâche centrale à encastrer Droite - Bois Compatible avec la serrure : FERCOMATIC Dimensions : 190 x 18 x 14 mm			10	-
	00013974	G-22826-01-L-1	Gâche centrale à encastrer Gauche - Bois Compatible avec la serrure : FERCOMATIC Dimensions : 190 x 18 x 14 mm			10	-
	00013970	E-22870-00-R-1	Gâche centrale à encastrer Droite - Bois Compatible avec les serrures : SECURY - EUROPA Dimensions : 190 x 18 x 14 mm			10	-
	00013971	E-22870-00-L-1	Gâche centrale à encastrer Gauche - Bois Compatible avec les serrures : SECURY - EUROPA Dimensions : 190 x 18 x 14 mm			10	-
	00013975	E-22867-00-R-1	Gâche centrale en applique (à toupiller) Droite - Bois Compatible avec la serrure : SECURY - EUROPA Dimensions : 188 x 16 x 14 mm			10	-
	00013976	E-22867-00-L-1	Gâche centrale en applique (à toupiller) Gauche - Bois Compatible avec la serrure : SECURY - EUROPA Dimensions : 188 x 16 x 14 mm			10	-
	00077032	0-2545-00-01	Gâche centrale à encastrer Réversible - Bois Compatible avec les serrures : DECENA Dimensions : 114 x 18 x 9 mm			10	-
	00077033	E-11640-00-01	Gâche centrale à encastrer Réversible - A 1 pêne ½ tour - Bois Compatible avec les serrures : DECENA - TRIMATIC Dimensions : 85 x 18 x 9 mm			10	-
	00077015	E-13065-00-R-1	Gâche centrale à encastrer Droite - Bois Compatible avec la serrure : DECENA Dimensions : 85 x 18 x 9 mm			10	-
	00077016	E-13065-00-L-1	Gâche centrale à encastrer Gauche - Bois Compatible avec la serrure : DECENA Dimensions : 85 x 18 x 9 mm			10	-
	00077018	E-11352-00-0-1	Gâche centrale à encastrer Réversible - Bois Compatible avec la serrure : DECENA Dimensions : 90 x 18 x 9 mm			10	-
	00077022	0-2747-00-R-1	Gâche équerre centrale à encastrer Droite - Bois Compatible avec les serrures : DECENA Dimensions : 212 x 18 x 18 mm			10	-



Pour porte d'entrée bois









	Réf. THIRARD	Réf. FERCO	Designation	Axe	Hauteur	Colis	Prix
	00077023	0-2746-00-L-1	Gâche équerre centrale à encastrer Gauche - Bois Compatible avec les serrures : DECENA Dimensions : 212 x 18 x 18 mm			10	-
	00077042	E-13742-00-R-1	Gâche centrale à encastrer Droite - Bois Compatible avec les serrures : TRIMATIC Dimensions : 190 x 18 x 13 mm			10	-
	00077034	9-34136-18-0-1	Gâche auxiliaire haut et bas Réversible - A défoncer - Bois Compatible avec la serrure : SECURY Auto Dimensions : 81 x 18 x 8,5 mm			10	-
	00077742	E-13742-00-L-1	Gâche centrale à encastrer Gauche - Bois Compatible avec la serrure : TRIMATIC Dimensions : 190 x 18 x 13 mm			10	-
	00077638	E-11638-00-0-1	Gâche gâlet à encastrer Réversible - Bois Compatible : DECENA • TRIMATIC • FERCOMATIC • EUROPA • SECURY Dimensions : 85 x 18 x 9 mm			10	-
	00077035	E-16922-00-01	Gâche auxiliaire haut et bas Réversible - A défoncer - Bois Compatible avec la serrure : FERCOMATIC Dimensions : 81 x 18 x 9 mm			10	-

Pour porte d'entrée bois - pvc











Réf. THIRARD	Réf. FERCO	Designation	Axe	Hauteur	Colis	Prix
00077010	G-22864-00-0-1	Gâche centrale à encastrer Réversible - Bois et pvc Compatible avec la serrure : EUROPA Dimensions : 208 x 17 x 7 mm			10	-
00077011	G-22898-00-R-1	Gâche centrale en applique DROITE - Bois et pvc Compatible avec la serrure : EUROPA - FERCOMATIC Dimensions : 208 x 17 x 8 mm			10	-
00077028	G-18254-31-R-1	Gâche centrale à encastrer Droite - Bois et pvc Compatible avec les serrures : EUROPA - FERCOMATIC Dimensions : 208 x 17 x 8,5 mm			10	-
00077029	G-18254-31-L-1	Gâche centrale à encastrer Gauche - Bois et pvc Compatible avec les serrures : EUROPA - FERCOMATIC Dimensions : 208 x 17 x 8,5 mm			10	-
00077013	G-22898-00-L-1	Gâche centrale en applique Gauche- Bois et pvc Compatible avec la serrure : EUROPA - FERCOMATIC Dimensions : 208 x 17 x 8 mm			10	-
00013967	0-0318-00-0-1	Gâche galet à encastrer Réversible - Bois et pvc Compatible avec les serrures : DECENA - TRIMATIC - UNIJET - SECURY - EUROPA - FERCOMATIC Dimensions : 90 x 16 x 11 mm			10	-
00013972	8-00872-00-0-1	Gâche galet à encastrer - Bois et pvc Réversible Compatible avec les serrures : DECENA - TRIMATIC - UNIJET - SECURY - EUROPA - FERCOMATIC Dimensions : 85 x 17 x 10 mm			10	-
00077014	8-00873-00-0-1	Gâche galet en applique Réversible- Bois et pvc Compatible avec la serrure : EUROPA - SECURY - FERCOMATIC Dimensions : 80 x 17 x 8 mm			10	-
00077017	E-11351-00-0-1	Gâche galet à encastrer Réversible - Bois Compatible avec les serrures : EUROPA - DECENA - FERCOMATIC Dimensions : 98 x 18 x 9 mm			10	-
00077037	E-13065-00-L-1	Gâche auxiliaire à verrouillage automatique Réversible - Bois Compatible avec la serrure : SECURY Auto Dimensions : 136 x 18 x 6 mm			10	-
00077025	8-00975-00-0-1	Gâche galet latéral - Bois et pvc Compatible avec les serrures CREMONE PE - FENSTER - UNIJET Dimensions : 42 x 14,5 x 8 mm»			10	-
00077026	9-33921-01-0-1	Gâche galet latéral - PVC Compatible avec les serrures CREMONE PE - FENSTER - UNIJET Dimensions : 45 x 15,5 x 8 mm»			10	-



Pour porte-fenêtre et fenêtre bois - pvc





	Réf. THIRARD	Réf. FERCO	Designation	Axe	Hauteur	Colis	Prix
	00013949	G-21001-16-0-1	Verrou à bascule Pêne rond coulissant 160 mm - pour porte fenêtre (bois)			10	-
	00013948	B-01008-01-0-1	Verrou à tèteière Dimensions : 200 x 16 mm - pour porte fenêtre (bois)			10	-
	00013953	G-16890-01-0-1	Verrou à levier avec sortie de tringle - pour fenêtre PVC			10	-
	00077012	A-R0112-00-0-1	Loquet à encastrer avec pêne et gâche Axe : 28 mm - Carré : 7 mm Dimensions : 60 x 38 mm - Tèteière : H 120 x 16 mm			10	-
	00077074	A-A0740-00-0-1	Loquet à encastrer avec pêne et gâche Axe : 10 mm - Carré : 7 mm Dimensions : 60 x 18 mm - Tèteière H 100 x 14 mm			10	-
	00077021	A-G0109-00-01	Loquet à encastrer avec pêne et gâche Axe : 17 mm - Carré : 7 mm Dimensions : 70 x 28 mm - Tèteière H 110 x 16 mm			10	-
	00002485	-	Béquille de crémone fenêtre - Blanc Ral 9010 Carré de 7 x 35 mm			10	-
	00002486	-	Béquille de crémone fenêtre à clé - Blanc Ral 9010 Carré de 7 x 35 - 2 clés			10	-

Pour porte-fenêtre et fenêtre bois - pvc

	Réf. THIRARD	Réf. FERCO	Designation	Axe	Hauteur	Colis	Prix
	00097008	G-14744-00-0-1	Crémone à tétière avec panneton - gâche Axe : 17 mm - Carré : 7 mm - Compatible avec la serrure : FENSTER Dimensions : 130 x 29 mm - Tétière : H 278 x 16 mm			1	-
	00077027	0-00321-00-01	Gâche de tringle à toupiller double pour fenêtre 2 vantaux Dimensions : 90 x 16 x 11 mm			10	-
	00077324	0-0324-00-0-1	Gâche centrale à encastrer Réversible Compatible avec la serrure : FENSTER Dimensions : 90 x 16 x 11 mm			10	-
	00077639	E-11639-00-0-1	Gâche centrale à encastrer Réversible Compatible avec la serrure : FENSTER Dimensions : 85 x 16 x 9 mm			10	-
	00077862	0-0295R-00-0-1	Gâche d'extrémité plate à encastrer Compatible avec la serrure : FENSTER - UNIJET Dimensions : 50 x 14 x 2 mm			10	-
	00077863	0-0395C-00-0-1	Gâche équerre de tringle d'extrémité Compatible avec la serrure : FENSTER - UNIJET Dimensions : 34 x 20 x 19 x 2 mm			10	-
	00077019	0-0309-00-0-1	Gâche de tringle d'extrémité à encastrer Compatible avec la serrure : FENSTER Dimensions : Ø 25 x 15 mm			10	-
	00013951	G-19821-01-R-1	Anti-fausse manœuvre de fenêtre - pose en feuillure Droite Pour fenêtre PVC Dimensions : 88 x 17 mm			10	-
	00077043	K-16467-09-R-1	Anti-fausse manœuvre de fenêtre Pour fenêtre oscillo-battante Droite - Bois et pvc Dimensions : 46 x 16 mm - Axe 9			10	-
	00077045	K-16467-13-R-1	Anti-fausse manœuvre de fenêtre Pour fenêtre oscillo-battante Droite - Bois et pvc Dimensions : 46 x 16 mm - Axe 13			10	-
	00013952	G-19821-01-L-1	Anti-fausse manœuvre de fenêtre - pose en feuillure Gauche Pour fenêtre PVC Dimensions : 88 x 17 mm			10	-
	00077044	K-16467-09-L-1	Anti-fausse manœuvre de fenêtre Pour fenêtre oscillo-battante Gauche - Bois et pvc Dimensions : 46 x 16 mm - Axe 9			10	-
	00077046	K-16467-13-L-1	Anti-fausse manœuvre de fenêtre Pour fenêtre oscillo-battante Gauche - Bois et pvc Dimensions : 46 x 16 mm - Axe 13			10	-
	00077047	6-29987-00-0-1	Releveur anti-fausse manœuvre de fenêtre Pour fenêtre oscillo-battante - Bois PVC Dimensions : 62 x 16 mm - Axe 13			10	-
	00013963	8-00670-02-0-1	Inverseur avec sortie de tringle Compatible avec les serrures : UNIJET Dimensions : 160 x 16 mm			10	-



Pour porte-fenêtre et fenêtre bois - pvc

	Réf. THIRARD	Réf. FERCO	Designation	Axe	Hauteur	Colis	Prix
	00013964	G-14661-00-0-1	Verrouillage haut avec sortie de tringle Compatible avec les serrures : UNIJET Dimensions : 160 x 16 mm			10	-
	00013981	E-19551-32-0-1	Gâche de tringle double pour fenêtre 2 vantaux Compatible avec la serrure : UNIJET Dimensions : 55 x 20 mm			10	-
	00013982	E-19550-32-0-1	Gâche galet latéral Compatible avec les serrures : Crémone PE - FENSTER - UNIJET Dimensions :			10	-
	00013983	E-19551-32-0-1	Gâche de tringle double pour fenêtre 2 vantaux Compatible avec la serrure : UNIJET Dimensions : 94 x 18 mm			10	-

Pour porte, porte-fenêtre et fenêtre bois - pvc





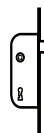



Réf. THIRARD	Réf. FERCO	Designation	Axe	Hauteur	Colis	Prix
00097005	G-18240-00-0-1	RALLONGE SUPPLÉMENTAIRE Compatible avec les serrures : DECENA - TRIMATIC Dimensions : H 250 mm - Pour tête : 18 mm			10	-
00097015	A-01197-04-0-1	Prolongateur de serrure à encastrer Prolongateur de serrure à encastrer Dimensions : H 370 mm - Pour tête : 16 mm			1	-
00097016	A-01197-06-0-1	Prolongateur de serrure à encastrer Compatible avec les serrures : FENSTER Dimensions : H 620 mm - Pour tête : 16 mm			1	-
00097017	A-01197-08-0-1	Prolongateur de serrure à encastrer Compatible avec les serrures : FENSTER Dimensions : H 870 mm - Pour tête : 16 mm			1	-
00097018	A-01197-11-0-1	Prolongateur de serrure à encastrer Compatible avec les serrures : FENSTER Dimensions : H 1120 mm - Pour tête : 16 mm			1	-
00013965	A-01197-36-0-1	PROLONGATEUR POUR CRÉMONE AJUSTABLE - avec 1 galet Compatible avec les serrures : FENSTER Dimensions : H 620 mm - Pour tête : 16 mm			1	-
00013966	A-01197-39-0-1	PROLONGATEUR POUR CRÉMONE AJUSTABLE - avec 1 galet Compatible avec les serrures : FENSTER Dimensions : H 870 mm - Pour tête : 16 mm			1	-
00013961	8-00625-00-0-1	RALLONGE SUPPLÉMENTAIRE Compatible avec les serrures : UNIJET Dimensions : H 250 mm - Pour tête : 16 mm			10	-
00013962	6-32142-00-0-1	RALLONGE SUPPLÉMENTAIRE Compatible avec les serrures : UNIJET Dimensions : H 500 mm - Pour tête : 16 mm			10	-
00013984	9-42301-18-0-1	Gâche galet latéral pour pose en applique Compatible avec les serrures : Crémone PE - UNIJET Dimensions : 54 x 17 mm			10	-
00013985	E-19551-32-0-1	Gâche de tringle simple pour fenêtre simple vantail Compatible avec les serrures : UNIJET Dimensions : 80 x 18 mm			10	-



Designation	Boite	Colis.	Prix	Sachet	Colis.	Prix	Brochable					Colis.	Prix
							France	Euro 1	Euro 2	Euro 3	Euro 4		
Supplément pour conditionnement de serrures à encastrer variées (pêne dormant ½ tour) Prix net	00001099	-	-	-	-	-	-	-	-	-	-	-	-
Jeu de gâches plates 20 mm bouts carrés (3 pènes rectangulaires)	00090619	10	-	-	-	-	00490619	-	-	-	-	10	-
Jeu de gâches plates 20 mm bouts ronds (3 pènes rectangulaires)	00091619	10	-	-	-	-	00491619	-	-	-	-	10	-
Jeu de gâches plates 20 mm bouts carrés (double pènes ronds Ø 10)	00089619	10	-	-	-	-	00489619	-	-	-	-	10	-
Jeu de gâches plates 20 mm bouts ronds (double pènes ronds Ø 10)	00088619	10	-	-	-	-	00488619	-	-	-	-	10	-
Jeu de gâches équerre 20 x 20 mm bouts ronds	00096619	10	-	-	-	-	00496619	-	-	-	-	10	-
Cylindre profilé TRANSIT 2 • 4 clés réversibles 30 x 30 mm (porte 38 à 46 mm)	00007330	1	-	-	-	-	00207330	-	-	-	-	5	-
Cylindre profilé TRANSIT 2 • 4 clés réversibles 35 x 30 mm (porte 43 à 51 mm)	00007335	1	-	-	-	-	00207335	-	-	-	-	5	-
Cylindre profilé TRANSIT 2 • 4 clés réversibles 40 x 30 mm (porte 48 à 56 mm)	00007340	1	-	-	-	-	00207340	-	-	-	-	5	-
Cylindre profilé TRANSIT 2 • 4 clés réversibles 45 x 30 mm (porte 53 à 61 mm)	00007345	1	-	-	-	-	00207345	-	-	-	-	5	-
Entrée acier pour serrure à larder	00000575	10	-	-	-	-	-	-	-	-	-	-	-
Entrée alu pour serr. à larder	00000576	10	-	-	-	-	-	-	-	-	-	-	-
Entrée à cuvette laiton 60 x 60 trou de clé	00041262	10	-	-	-	-	00141262	-	-	-	-	10	-
Entrée à cuvette laiton chromé 60 x 60 trou de clé	00041263	10	-	-	-	-	00141263	-	-	-	-	10	-
Entrée à cuvette laiton 60 x 60 trou de Cylindre	00041264	10	-	00941264	30	-	00141264	-	-	-	-	10	-
Entrée à cuvette laiton chromé 60 x 60 trou de Cylindre	00041265	10	-	00941265	30	-	00141265	-	-	-	-	10	-
Rosace laiton trou de cylindre européen	00082900	10	-	-	-	-	00182900	-	-	-	-	10	-
Clé de blocage pour serrure à encastrer	00096770	10	-	-	-	-	00196770	-	-	-	-	10	-

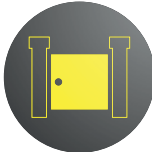
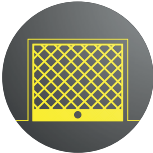

Serrures à appliquer

PORTE D'ENTREE		770	PORTE INTERIEURE		836
PORTE VITREE		842	PORTE DE CAVE		844
PORTE DE GARAGE		850	PORTAIL		855
RIDEAU METALLIQUE		881	INDUSTRIE		883
ACCESSOIRES		894			



*Sommaire détaillé par produit
page suivante*



*Chapitre SERRURE de MEUBLE
page 902*



Serrures à appliquer

PORTE D'ENTREE



Horizontale 4 gorges		770
Verticale 4 gorges		771
Horizontale 6 gorges		772
Verticale 6 gorges		773
Horizontale à cylindre		774
Horizontale à cylindre		775
Horizontale à cylindre		776
Verticale à cylindre		778
Verticale à cylindre		780
Horizontale à commande électrique		781
Horizontale à cylindre		782
Horizontale à cylindre et bouton à tirage		783
Horizontale à cylindre profilé		784
Verticale à cylindre profilé		785
Horizontale pour cylindre profilé		786
Verticale pour cylindre profilé		787
Horizontale pour cylindre profilé		788
Verticale pour cylindre profilé		789
Verticale «Alasace» pour cylindre profilé		790
Horizontale pour CP axe réglable		791

Horizontale pour cylindre profilé		792
Verticale pour cylindre profilé		793
Horizontale cylindre RIM		794
Serrure tubulaire à cylindre		794
Serrure tubulaire à cylindre		795
Serrure 3 points HORGÀ CR		797
Serrure 3 points TARGA CR		799
Serrure 3 points BELUGA CR		802
Serrure 3 points HORGÀ CP		805
Serrure 3 points CARENE		807
Serrure 3 points TARGA CP		809
Serrure 3 points MELISSA		811
Serrure 3 points BELUGA CP		814
Serrure 3 points TARGA CR A2P*		817
Serrure 3 points / BELUGA CR A2P*		819

Serrure 3 points HORGÀ CP A2P*		821
Serrure 3 points TARGA CP A2P*		823
Serrure 3 points BELUGA CP A2P*		825
Serrure 3 points BELUGA A2P**		827
Serrure 3 points		828
Serrure 3 points		828
Serrure 3 points		829
Serrure 3 points		829
Serrure 3 points TRIBANDO		832
Serrure 3 points / TRIBANDO A2P*		835

PORTE INTERIEURE





Horizontale bec de cane		836
Horizontale pêne dormant 1/2 tour		837
Verticale pêne dormant 1/2 tour		838
Verticale «Alsace» pêne dormant 1/2 tour		839

Horizontale cylindre RIM		840
Horizontale cylindre RIM		840
Serrure tubulaire bec de cane et condamnation		841

PORTE VITREE



Serrure porte en verre		842
Serrure porte en verre		843





PORTE DE CAVE



Horizontale pêne dormant		844
Horizontale pêne dormant		845
Horizontale 6 gorges - PDT seul		846
Verticale 6 gorges - PDT seul		847
Horizontale pour CP - PDT seul		848
Verticale pour CP - PDT seul		849





PORTE DE GARAGE



Serrure à cylindre et bouton poussoir		850
Serrure à cylindre et bouton - à tirage		851
Serrure pour cylindre profilé		852
Serrure pour porte basculante		853
Serrure pour porte basculante		854

PORTAIL





Horizontale pêne dormant 1/2 tour		855
Verticale pêne dormant 1/2 tour		856
Horizontale 4 gorges		857
Horizontale 4 gorges - à crochet		858

Horizontale 4 gorges		859
Horizontale 4 gorges		860
Verticale 4 gorges		861
Horizontale 6 gorges		862
Verticale 6 gorges		863
Horizontale pour cylindre profilé		864
Horizontale pour CP - à crochet		865
Horizontale pour cylindre profilé		866
Horizontale pour cylindre profilé		867
Verticale pour cylindre profilé		868
Verticale pour cylindre profilé, pêne réglable		869
Verticale pour cylindre profilé, pêne levant		870
Verticale pêne rentrant		871
Verticale à souder		872
Verticale à souder		873
Gâche butée		874
Verticale à visser pêne réglable		875
Verticale à visser pêne réglable		876
Verticale pour cylindre profilé		877
Verticale pour cylindre profilé		878
Horizontale à commande électrique		879
Verticale à combinaison		880









RIDEAU METALLIQUE









Fermeture pour rideau métallique		881
Serrure pour cylindre rond		882
Serrure pour cylindre profilé		882

INDUSTRIE



Serrure à plastron		883
Antipanique D-CROSS		885
Antipanique S-PUSH		887
Antipanique U-CROSS		889
Crémone SLIM		891
Crémone SLIM CF		892
Boitier de serrure applique CP - pêne dormant		893
Boitier de serrure applique CP - pêne dormant		893

ACCESSOIRES

Gâche à commande électrique		894
Gâche à commande électrique		895
Gâche à commande électrique		896
Gâche à commande électrique		897
Gaîne passe cable		898
Transmetteur de courant		898
Entrées, Rosaces		899



Serrure applique horizontale / 4 GORGES

PROTECT



GARANTIE



X 2

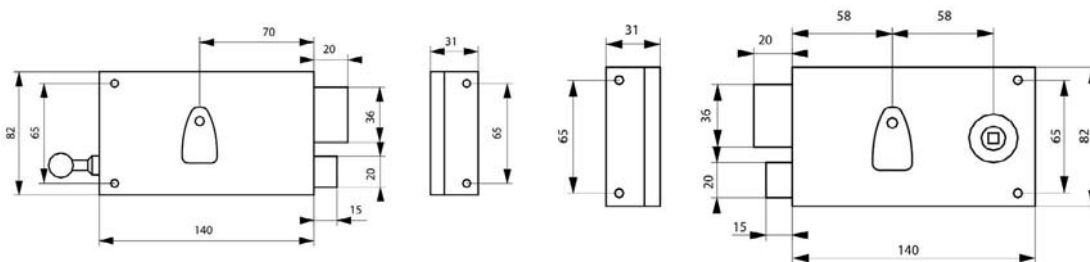

Description/Description/Descripción

Coffre et gâche acier cambré. Pêne acier. Demi-tour acier. Canon alliage long. 40 mm. Mécanisme à 4 gorges 2 tours avec tirage ou à fouillot. Pêne 1/2 tour réversible pour porte ouvrant à l'extérieur. Carré 6 mm. 2 clés nickelées. 12 variures. Entrée de clé et de fouillot acier. A TIRAGE : Rappel du demi-tour par la clé

Cambered steel case and striker. Steel bolt - Steel latch. Alloy bush 40 mm length. 4 lever mechanism double latch with drawback pull and follower. Drawback of the latch by key. Latch bolt reversible for outside opening door. Square 6 mm. 2 nickel plated keys. 12 key differs. Steel key hole and follower plate.

Caja y cerradero de acero curvado. Pestillo de acero. Media vuelta de acero. Cañón de aleación, long. 40 mm.

Mecanismo de 4 canalillos 2 vueltas con tirador o de nuez. Reposición de la media vuelta con la llave. Pestillo de media vuelta reversible para puertas con apertura hacia el exterior. Cuadrado 6 mm. 2 llaves niqueladas. 12 perfiles de llave. Entrada de la llave y de la nuez de acero.

Finition/Finish/Acabado

Epoxy noir granité
Granited black epoxy
Epoxi negro granitado

Version/Option/Versión

A TIRAGE. Droite et gauche.
Drawback pull. Right and left hand.
Con tirador. Derecha e izquierda.

Designation	Boite	Colis.	Prix	Sachet	Colis.	Prix	Brochable				Colis.	Prix	
							France	Euro 1	Euro 2	Euro 3			Euro 4
SERR. 4 gorges à tirage 140x82 mm droite	00000112	1	-	00900112	10	-	00500112	-	-	-	-	5	-
SERR. 4 gorges à tirage 140x82 mm gauche	00000122	1	-	00900122	10	-	00500122	-	-	-	-	5	-
SERR. 4 gorges à fouillot 140x82 mm droite	00000113	1	-	00900113	10	-	00500113	-	-	-	-	5	-
SERR. 4 gorges à fouillot 140x82 mm gauche	00000123	1	-	00900123	10	-	00500123	-	-	-	-	5	-
SERR. 4 gorges PDT seul 140x82 mm drte	00004113	1	-	-	-	-	-	-	-	-	-	-	-
SERR. 4 gorges PDT seul 140x82 mm gche	00004123	1	-	-	-	-	-	-	-	-	-	-	-

⚠ Non stocké/Non-stored/Producto no estocado - ☑ Sur stock Europe Zone 1 et Zone 2, nous consulter pour délai d'approvisionnement - ☒ Epuisement/Stock depletion/Agotamiento del stock

Serrure applique verticale / 4 GORGES

PROTECT



GARANTIE



X 2

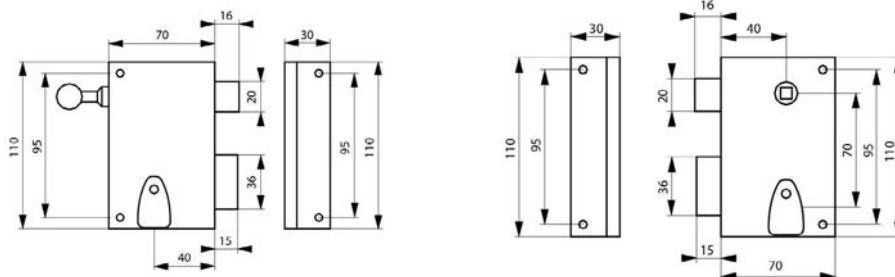

Description/Description/Descripción

Coffre et gâche acier cambré. Pêne acier. Demi-tour acier. Canon alliage long. 40 mm. Mécanisme à 4 gorges 2 tours avec tirage ou à fouillot. Pêne 1/2 tour réversible pour porte ouvrant à l'extérieur. Carré 7 mm. 2 clés nickelées. 12 variures. Entrée de clé et de fouillot acier. A TIRAGE : Rappel du demi-tour par la clé

Cambered steel case and striker. Steel bolt - Steel latch. Alloy bush 40 mm length. 4 lever mechanism double latch with drawback pull and follower. Drawback of the latch by key. Latch bolt reversible for outside opening door. Square 7 mm. 2 nickel plated keys. 12 key differs. Steel key hole and follower plate.

Caja y cerradero de acero curvado. Pestillo de acero.

Media vuelta de acero. Cañón de aleación, long. 40 mm.

Mecanismo de 4 canalillos 2 vueltas con tirador o de nuez. Reposición de la media vuelta con la llave. Pestillo de media vuelta reversible para puertas con apertura hacia el exterior. Cuadrado 7 mm. 2 llaves niqueladas. 12 perfiles de llave. Entrada de la llave y de la nuez de acero.

Finition/Finish/Acabado

Epoxy noir granité

Granited black epoxy

Epoxi negro granitado

Version/Option/Versión

A TIRAGE. Droite et gauche.

Drawback pull. Right and left hand.

Con tirador. Derecha e izquierda.

Designation	Boite	Colis.	Prix	Sachet	Colis.	Prix	Brochable					Colis.	Prix
							France	Euro 1	Euro 2	Euro 3	Euro 4		
SERRURE à tirage 70 x 110 mm drte	00000132	1	-	00900132	10	-	00300132	-	-	-	-	5	-
SERRURE à tirage 70 x 110 mm gche	00000142	1	-	00900142	10	-	00300142	-	-	-	-	5	-
SERRURE à fouillot 70 x 110 mm drte	00000133	1	-	00900133	10	-	00300133	-	-	-	-	5	-
SERRURE à fouillot 70 x 110 mm gche	00000143	1	-	00900143	10	-	00300143	-	-	-	-	5	-

Non stocké/Non-stored/Producto no estocado - Sur stock Europe Zone 1 et Zone 2, nous consulter pour délai d'approvisionnement - Epuisement/Stock depletion/Agotamiento del stock

Serrure applique horizontale / 6 GORGES

PROTECT



GARANTIE



X 2

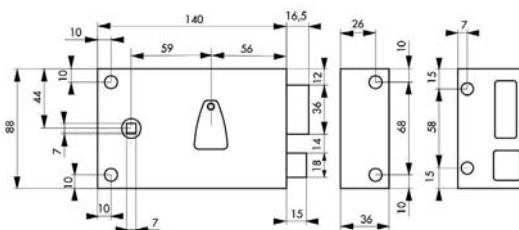
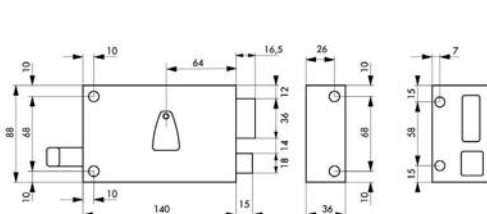

Description/Description/Descripción

Coffre et gâche acier cambré. Pêne acier. Demi-tour acier. Canon alliage long. 45 mm. Mécanisme à 6 gorges 2 tours avec tirage ou à fouillot. Carré 7 mm. 2 clés nickelées. 2 variures. Entrée de clé acier. A TIRAGE : Rappel du demi-tour par la clé
Cambered steel case and striker. Steel bolt. Steel latch. Alloy bush 45 mm length. 6 lever mechanism double latch with drawback pull and follower. Drawback of the latch by key. Square 7 mm. 2 nickel plated keys. 20 key differs. Steel key hole.

Caja y cerradero de acero curvado. Pestillo de acero. Media vuelta de acero. Cañón de aleación, long. 45 mm. Mecanismo de 6 canalillos 2 vueltas con tirador o de nuez. Reposición de la media vuelta con la llave. Cuadrado 7 mm. 2 llaves níqueladas. 20 perfiles de llave. Entrada de la llave de acero.

Finition/Finish/Acabado

Epoxy noir granité
Granited black epoxy
 Epoxi negro granitado

Version/Option/Versión

A TIRAGE. Droite et gauche.
Drawback pull. Right and left hand.
 Con tirador. Derecha e izquierda.

Designation	Boite	Colis.	Prix	Sachet	Colis.	Prix	Brochable					Colis.	Prix
							France	Euro 1	Euro 2	Euro 3	Euro 4		
SERR. 6 gorges à tirage 140x88 mm droite	00032010	1	-	-	-	-	-	-	-	-	-	-	-
SERR. 6 gorges à tirage 140x88 mm gauche	00032020	1	-	-	-	-	-	-	-	-	-	-	-
SERR. 6 gorges à fouillot 140x88 mm droite	00032110	1	-	-	-	-	-	-	-	-	-	-	-
SERR. 6 gorges à fouillot 140x88 mm gauche	00032120	1	-	-	-	-	-	-	-	-	-	-	-

⚠ Non stocké/Non-stored/Producto no estocado - ☑ Sur stock Europe Zone 1 et Zone 2, nous consulter pour délai d'approvisionnement - ☒ Epuisement/Stock depletion/Agotamiento del stock

Serrure applique verticale / 6 GORGES

PROTECT



GARANTIE



X 2

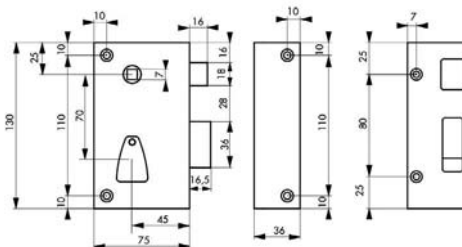
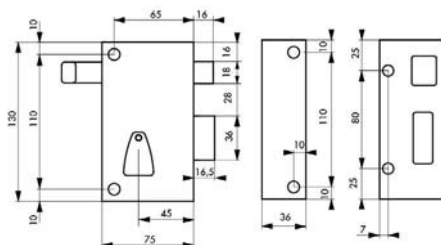

Description/Description/Descripción

Coffre et gâche acier cambré. Pêne acier. Demi-tour acier. Canon alliage long. 45 mm. Mécanisme à 6 gorges 2 tours avec tirage ou à fouillot. Carré 7 mm. 2 clés nickelées. 2 variures. Entrée de clé acier. A TIRAGE : Rappel du demi-tour par la clé
Cambered steel case and striker. Steel bolt - Steel latch. Alloy bush 45 mm length. 6 lever mechanism double latch with drawback pull and follower. Drawback of the latch by key. Square 7 mm. 2 nickel plated keys. 20 key differs. Steel key hole.

Caja y cerradero de acero curvado. Pestillo de acero. Media vuelta de acero. Cañón de aleación, long. 45 mm. Mecanismo de 6 canalillos 2 vueltas con tirador o de nuez. Reposición de la media vuelta con la llave. Cuadrado 7 mm. 2 llaves niqueladas. 20 perfiles de llave. Entrada de la llave de acero.

Finition/Finish/Acabado

Epoxy noir granité

Granited black epoxy

Epoxi negro granitado

Version/Option/Versión

A TIRAGE. Droite et gauche.

Drawback pull. Right and left hand.

Con tirador. Derecha e izquierda.



Designation	Boite	Colis.	Prix	Sachet	Colis.	Prix	Brochable					Colis.	Prix
							France	Euro 1	Euro 2	Euro 3	Euro 4		
SERR. à tirage 75 x 130 mm droite	00034010	1	-	-	-	-	-	-	-	-	-	-	-
SERR. à tirage 75 x 130 mm gauche	00034020	1	-	-	-	-	-	-	-	-	-	-	-
SERR. à fouillot 75 x 130 mm droite	00034110	1	-	-	-	-	-	-	-	-	-	-	-
SERR. à fouillot 75 x 130 mm gauche	00034120	1	-	-	-	-	-	-	-	-	-	-	-

Non stocké/Non-stored/Producto no estocado - Sur stock Europe Zone 1 et Zone 2, nous consulter pour délai d'approvisionnement - Epuisement/Stock depletion/Agotamiento del stock

Serrure applique horizontale / A CYLINDRE

ECO



GARANTIE



X 3

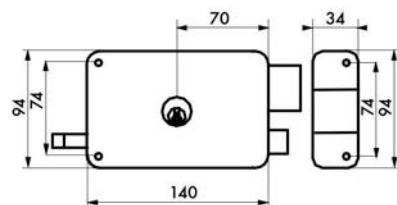
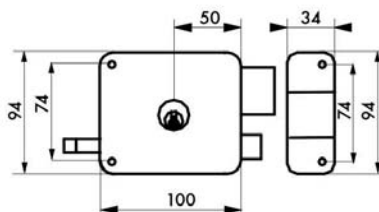

Description/Description/Descripción

Coffre et gâche acier embouti. Pêne laiton, demi-tour laiton. Mécanisme à 3 tours. Rappel du demi-tour par la clé. Double cylindre laiton 5 goupilles long. 45 mm. 3 clés laiton nickelé. Ref 00094339 et 00094338 : pêne et demi tour en zamak, mécanisme à 2 tours
Pressed steel case and striker. Brass bolt. Brass latch. 3 latch mechanism. Drawback of the latch by key. Double brass cylinder 5 pins length 45 mm. 3 brass nickel plated keys. Ref 00094339 and 00094338: zamak latch and half turn, 2 turn mechanism

Caja y cerradero de acero embutido. Pestillo de latón. Media vuelta de latón. Mecanismo de 3 vueltas. Reposición de la media vuelta con la llave. Doble cilindro de latón 5 pasadores long. 45 mm. 3 llaves de latón niqueladas. Ref 00094339 y 00094338: pestillo de zamak y mecanismo de media vuelta, 2 vueltas

Finition/Finish/Acabado

Epoxy marron

Brown epoxy

Epoxi marrón

Version/Option/Versión

Droite et gauche

Right and left hand

Derecha e izquierda

Designation	Boite	Colis.	Prix	Sachet	Colis.	Prix	Brochable					Colis.	Prix
							France	Euro 1	Euro 2	Euro 3	Euro 4		
SERR. à DC à tirage 100 x 94 mm droite	00094334	1	-	-	-	-	-	-	-	00594334	-	5	-
SERR. à DC à tirage 100 x 94 mm gauche	00094333	1	-	-	-	-	-	-	-	00594333	-	5	-
SERR. à DC à tirage 140 x 94 mm droite	00094339	1	-	-	-	-	-	-	-	00594339	-	5	-
SERR. à DC à tirage 140 x 94 mm gauche	00094338	1	-	-	-	-	-	-	-	00594338	-	5	-

⚠ Non stocké/Non-stored/Producto no estocado - ☑ Sur stock Europe Zone 1 et Zone 2, nous consulter pour délai d'approvisionnement - ☑ Epuisement/Stock depletion/Agotamiento del stock

Serrure applique horizontale / A CYLINDRE

ECO



GARANTIE



X 3

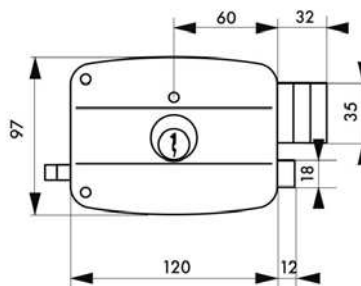
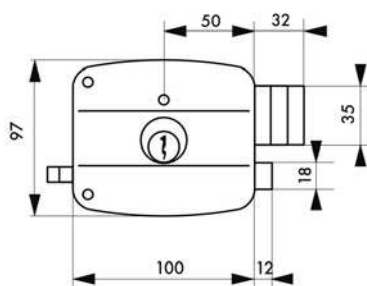

Description/Description/Descripción

Coffre et gâche acier embouté. Pêne laiton, demi-tour laiton. Mécanisme à 3 tours. Double cylindre laiton long. 45 mm. Entrée de cylindre et de fouillot acier.

Pressed steel case and striker. Brass bolt. Brass latch. 3 latch mechanism. Double brass cylinder length 45 mm. Steel cylinder hole and follower plate.

Caja y cerradero de acero embutido. Pestillo de latón. Media vuelta de latón. Mecanismo de 3 vueltas. Doble cilindro de latón long. 45 mm. Entrada de cilindro y de la nuez acero.

Finition/Finish/Acabado

Epoxy noir granité
Granited black epoxy
Epoxi negro granitado

Version/Option/Versión

Droite et gauche
Right and left hand
Derecha e izquierda



Designation	Boite	Colis.	Prix	Sachet	Colis.	Prix	Brochable					Colis.	Prix
							France	Euro 1	Euro 2	Euro 3	Euro 4		
SERR. à DC à tirage 100x97 mm droite	00094695	1	-	00994695	10	-	-	-	-	00594695	-	5	-
SERR. à DC à tirage 100x97 mm gauche	00094696	1	-	00994696	10	-	-	-	-	00594696	-	5	-
SERR. à DC à tirage 120x97 mm droite	00094697	1	-	00994697	10	-	-	-	-	00594697	-	5	-
SERR. à DC à tirage 120x97 mm gauche	00094698	1	-	00994698	10	-	-	-	-	00594698	-	5	-

⚠ Non stocké/Non-stored/Producto no estocado - 📦 Sur stock Europe Zone 1 et Zone 2, nous consulter pour délai d'approvisionnement - ⚠ Epuisement/Stock depletion/Agotamiento del stock

Serrure applique horizontale / A CYLINDRE

ECO



GARANTIE



X 3

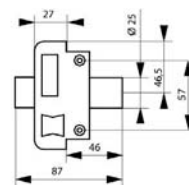
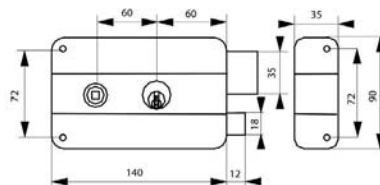
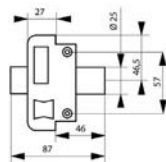
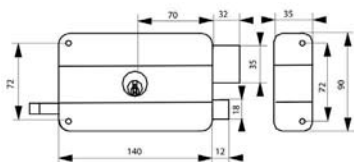

Description/Description/Descripción

Coffre et gâche acier embouti. Pêne laiton, demi-tour laiton. Mécanisme à 3 tours. Rappel du demi-tour par la clé. Double cylindre laiton 5 goupilles long. 45 mm. Carré 6 mm. Entrée de cylindre et de fouillot acier. 3 clés laiton nickelé.

Pressed steel case and striker. Brass bolt. Brass latch. 3 latch mechanism. Drawback of the latch by key. Double brass cylinder 5 pins length 45 mm. Square 6 mm. Steel cylinder hole and follower plate. 3 brass nickel plated keys.

Caja y cerradero de acero embutido. Pestillo de latón. Media vuelta de latón. Mecanismo de 3 vueltas. Reposición de la media vuelta con la llave. Doble cilindro de latón 5 pasadores long. 45 mm. Cuadrado 6 mm.

Entrada de cilindro y de la nuez acero. 3 llaves de latón niquelado.

Finition/Finish/Acabado

Epoxy noir granité
Granited black epoxy
Epoxi negro granitado

Version/Option/Versión

A TIRAGE. Droite et gauche. Cylindre HG5, TRANSIT2. Possibilité d'organigramme compatible avec système HG5 et Transit 2.

Drawback pull. Right and left hand. Cylinder HG5, TRANSIT2. Master keyed system available HG5 and TRANSIT2.

Con tirador. Derecha e izquierda. Cilindro HG5, TRANSIT2. Posibilidad de organigrama HG5 y TRANSIT2.

Designation	Boite	Colis.	Prix	Sachet	Colis.	Prix	Brochable					Colis.	Prix
							France	Euro 1	Euro 2	Euro 3	Euro 4		
SERRURE à DOUBLE CYLINDRE à tirage droit	00008115	1	-	00908115	10	-	00508115	-	-	00594652	-	2	-
SERRURE à DOUBLE CYLINDRE à tirage gauche	00008125	1	-	00908125	10	-	00508125	-	-	00594653	-	2	-

⚠ Non stocké/Non-stored/Producto no estocado - 📦 Sur stock Europe Zone 1 et Zone 2, nous consulter pour délai d'approvisionnement - 📦 Epuisement/Stock depletion/Agotamiento del stock

Serrure applique horizontale / A CYLINDRE

ECO



Designation	Boite	Colis.	Prix	Sachet	Colis.	Prix	Brochable					Colis.	Prix
							France	Euro 1	Euro 2	Euro 3	Euro 4		
SERRURE à DOUBLE CYLINDRE à fouillot droite	00008116	1	-	00908116	10	-	00508116	-	-	00594650	-	2	-
SERRURE à DOUBLE CYLINDRE à fouillot gauche	00008126	1	-	00908126	10	-	00508126	-	-	00594651	-	2	-
SERR. à DC 45 mm HG5 à tirage droite	00088115 <small>NS</small>	1	-	-	-	-	-	-	-	-	-	-	-
SERR. à DC 45 mm HG5 à tirage gauche	00088125 <small>NS</small>	1	-	-	-	-	-	-	-	-	-	-	-
SERR. à DC 45 mm HG5 à fouillot droite	00088116 <small>NS</small>	1	-	-	-	-	-	-	-	-	-	-	-
SERR. à DC 45 mm HG5 à fouillot gauche	00088126 <small>NS</small>	1	-	-	-	-	-	-	-	-	-	-	-
SERR. à DC 60 mm HG5 à tirage droite	00088215 <small>NS</small>	1	-	-	-	-	-	-	-	-	-	-	-
SERR. à DC 60 mm HG5 à tirage gauche	00088225 <small>NS</small>	1	-	-	-	-	-	-	-	-	-	-	-
SERR. à DC 60 mm HG5 à fouillot droite	00088216 <small>NS</small>	1	-	-	-	-	-	-	-	-	-	-	-
SERR. à DC 60 mm HG5 à fouillot gauche	00088226 <small>NS</small>	1	-	-	-	-	-	-	-	-	-	-	-
SERR. à DC 45 mm TRANSIT2 à tirage droite	00089115 <small>NS</small>	1	-	-	-	-	-	-	-	-	-	-	-
SERR. à DC 45 mm TRANSIT2 à tirage gauche	00089125 <small>NS</small>	1	-	-	-	-	-	-	-	-	-	-	-
SERR. à DC 45 mm TRANSIT2 à fouillot droite	00089116 <small>NS</small>	1	-	-	-	-	-	-	-	-	-	-	-
SERR. à DC 45 mm TRANSIT2 à fouillot gauche	00089126 <small>NS</small>	1	-	-	-	-	-	-	-	-	-	-	-
SERR. à DC 60 mm TRANSIT2 à tirage droite	00089215 <small>NS</small>	1	-	-	-	-	-	-	-	-	-	-	-
SERR. à DC 60 mm TRANSIT2 à tirage gauche	00089225 <small>NS</small>	1	-	-	-	-	-	-	-	-	-	-	-
SERR. à DC 60 mm TRANSIT2 à fouillot droite	00089216 <small>NS</small>	1	-	-	-	-	-	-	-	-	-	-	-
SERR. à DC 60 mm TRANSIT2 à fouillot gauche	00089226 <small>NS</small>	1	-	-	-	-	-	-	-	-	-	-	-

Tarif conditionnement non décolisable

SERRURE A APPLIQUER 140x90 mm double cylindre à tirage droite, epoxy noir granité - par 30 pièces	00038115	30	-	-	-	-	-	-	-	-	-	-	-
SERRURE A APPLIQUER 140x90 mm double cylindre à tirage gauche, epoxy noir granité- par 30 pièces	00038125	30	-	-	-	-	-	-	-	-	-	-	-
SERRURE A APPLIQUER 140x90 mm double cylindre à fouillot droite, epoxy noir granité- par 30 pièces	00038116	30	-	-	-	-	-	-	-	-	-	-	-
SERRURE A APPLIQUER 140x90 mm double cylindre à fouillot gauche, epoxy noir granité- par 30 pièces	00038126	30	-	-	-	-	-	-	-	-	-	-	-

NS Non stocké/Non-stored/Productos no estocado - ■ Sur stock Europe Zone 1 et Zone 2, nous consulter pour délai d'approvisionnement - E Epuiselement/Stock depletion/Agotamiento del stock



Serrure applique verticale / A CYLINDRE

ECO



GARANTIE



X 3

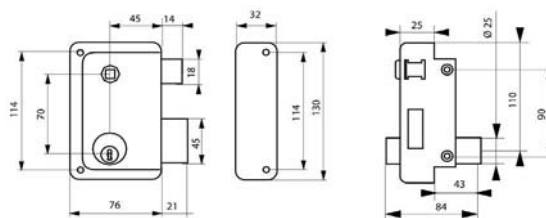
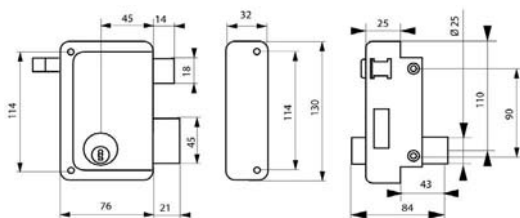

Description/Description/Descripción

Coffre et gâche acier embouti. Pêne laiton. Demi-tour laiton. Mécanisme à 2 tours. Rappel du demi-tour par la clé. Double cylindre laiton 5 goupilles. long. 45 mm. Carré 7 mm. Entrée de cylindre et de fouillot acier. 3 clés laiton nickelé

Pressed steel case and striker. Brass bolt. Brass latch. Double latch mechanism. Drawback of the latch by key. Double brass cylinder 5 pins length 45 mm. Square 7 mm. Steel cylinder hole and follower plate. 3 brass nickel plated keys.

Caja y cerradero de acero embutido. Pestillo y de latón. Media vuelta de latón. Mecanismo de 2 vueltas. Reposición de la media vuelta con la llave. Doble cilindro de latón 5 pasadores long. 45 mm. Cuadrado 7 mm.

Entrada de cilindro y de la nuez acero. 3 llaves de latón niquelado.

Finition/Finish/Acabado

Epoxy noir granité
Granited black epoxy
Epoxi negro granitado

Version/Option/Versión

A TIRAGE. Droite et gauche. Cylindre HG5, TRANSIT2. Possibilité d'organigramme compatible avec système HG5 et Transit 2.

Drawback pull. Right and left hand. Cylinder HG5, TRANSIT2. Master keyed system available HG5 and TRANSIT2.

Con tirador. Derecha e izquierda. Cilindro HG5, TRANSIT2. Posibilidad de organigrama HG5 y TRANSIT2.

Designation	Boite	Colis.	Prix	Sachet	Colis.	Prix	Brochable					Colis.	Prix
							France	Euro 1	Euro 2	Euro 3	Euro 4		
SERR. à DC à tirage 76 x 130 mm drte	00008135	1	-	00908135	10	-	00308135	-	-	00394508	-	2	-
SERR. à DC à tirage 76 x 130 mm gche	00008145	1	-	00908145	10	-	00308145	-	-	00394507	-	2	-

⚠ Non stocké/Non-stored/Producto no estocado - 📦 Sur stock Europe Zone 1 et Zone 2, nous consulter pour délai d'approvisionnement - 📦 Epuisement/Stock depletion/Agotamiento del stock

Serrure applique verticale / A CYLINDRE

ECO



Designation	Boite	Colis.	Prix	Sachet	Colis.	Prix	Brochable					Colis.	Prix
							France	Euro 1	Euro 2	Euro 3	Euro 4		
SERR. à DC à fouillot 76 x 130 mm drte	00008136	1	-	00908136	10	-	00308136	-	-	00394654	-	2	-
SERR. à DC à fouillot 76 x 130 mm gche	00008146	1	-	00908146	10	-	00308146	-	-	00394655	-	2	-
SERR. à DC 45 mm HG5 à tirage droite	00088135 <small>NS</small>	1	-	-	-	-	-	-	-	-	-	-	-
SERR. à DC 45 mm HG5 à tirage gauche	00088145 <small>NS</small>	1	-	-	-	-	-	-	-	-	-	-	-
SERR. à DC 45 mm HG5 à fouillot droite	00088136 <small>NS</small>	1	-	-	-	-	-	-	-	-	-	-	-
SERR. à DC 45 mm HG5 à fouillot gauche	00088146 <small>NS</small>	1	-	-	-	-	-	-	-	-	-	-	-
SERR. à DC 60 mm HG5 à tirage droite	00088235 <small>NS</small>	1	-	-	-	-	-	-	-	-	-	-	-
SERR. à DC 60 mm HG5 à tirage gauche	00088245 <small>NS</small>	1	-	-	-	-	-	-	-	-	-	-	-
SERR. à DC 60 mm HG5 à fouillot droite	00088236 <small>NS</small>	1	-	-	-	-	-	-	-	-	-	-	-
SERR. à DC 60 mm HG5 à fouillot gauche	00088246 <small>NS</small>	1	-	-	-	-	-	-	-	-	-	-	-
SERR. à DC 45 mm TRANSIT2 à tirage droite	00089135 <small>NS</small>	1	-	-	-	-	-	-	-	-	-	-	-
SERR. à DC 45 mm TRANSIT2 à tirage gauche	00089145 <small>NS</small>	1	-	-	-	-	-	-	-	-	-	-	-
SERR. à DC 45 mm TRANSIT2 à fouillot droite	00089136 <small>NS</small>	1	-	-	-	-	-	-	-	-	-	-	-
SERR. à DC 45 mm TRANSIT2 à fouillot gauche	00089146 <small>NS</small>	1	-	-	-	-	-	-	-	-	-	-	-
SERR. à DC 60 mm TRANSIT2 à tirage droite	00089235 <small>NS</small>	1	-	-	-	-	-	-	-	-	-	-	-
SERR. à DC 60 mm TRANSIT2 à tirage gauche	00089245 <small>NS</small>	1	-	-	-	-	-	-	-	-	-	-	-
SERR. à DC 60 mm TRANSIT2 à fouillot droite	00089236 <small>NS</small>	1	-	-	-	-	-	-	-	-	-	-	-
SERR. à DC 60 mm TRANSIT2 à fouillot gauche	00089246 <small>NS</small>	1	-	-	-	-	-	-	-	-	-	-	-

Tarif conditionnement non décolisable

SERRURE A APPLIQUER 76x130 mm double cylindre à tirage droite, epoxy noir granité - par 30 pieces	00038135	30	-	-	-	-	-	-	-	-	-	-	-
SERRURE A APPLIQUER 76x130 mm double cylindre à tirage gauche, epoxy noir granité- par 30 pieces	00038145	30	-	-	-	-	-	-	-	-	-	-	-
SERRURE A APPLIQUER 76x130 mm double cylindre à fouillot droite, epoxy noir granité- par 30 pieces	00038136	30	-	-	-	-	-	-	-	-	-	-	-
SERRURE A APPLIQUER 76x130 mm double cylindre à fouillot gauche, epoxy noir granité- par 30 pieces	00038146	30	-	-	-	-	-	-	-	-	-	-	-

NS Non stocké/Non-stored/Productos no estocado - ☑ Sur stock Europe Zone 1 et Zone 2, nous consulter pour délai d'approvisionnement - E Epuiselement/Stock depletion/Agotamiento del stock



Serrure applique verticale / A CYLINDRE

ECO



GARANTIE



X 3

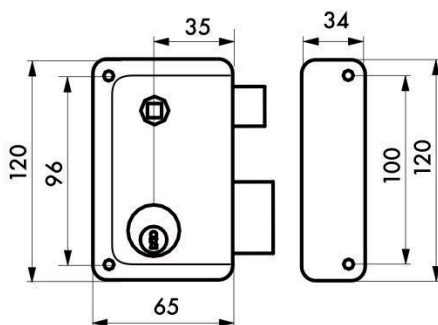

Description/Description/Descripción

Coffre et gâche acier embouti. Pêne alliage nickelé. Demi-tour alliage nickelé. Mécanisme à 1 tour. Double cylindre laiton 5 goupilles. long. 50 mm. Carré 8 Entrée de cylindre et de fouillot acier laitonné. 3 clés laiton nickelé
Pressed steel case and striker. Nickel plated alloy dead bolt. Nickel plated alloy latch. One latch mechanism. Double brass cylinder 5 pins length 50 mm. Square 8 mm. Brass plated steel cylinder hole and follower plate. 3 brass nickel plated keys.

Caja y cerradero de acero embutido. Pestillo de aleación níquelada. Media vuelta de aleación níquelada. Mecanismo de 1 vuelta. Doble cilindro de latón 5 pasadores long. 50 mm. Cuadrado 8 mm. Entrada de cilindro y de la nuez acero latonado. 3 llaves de latón níqueladas.

Finition/Finish/Acabado

Epoxy marron

Brown epoxy

Epoxi marrón

Version/Option/Versión

Droite et gauche

Right and left hand

Derecha e izquierda

Designation	Boite	Colis.	Prix	Sachet	Colis.	Prix	Brochable					Colis.	Prix
							France	Euro 1	Euro 2	Euro 3	Euro 4		
SERR. à DC à fouillot 65 x 120 mm droite	00094341	1	-	-	-	-	-	-	-	00394341	-	5	-
SERR. à DC à fouillot 65 x 120 mm gauche	00094340	1	-	-	-	-	-	-	-	00394340	-	5	-

⚠ Non stocké/Non-stored/Producto no estocado - 📦 Sur stock Europe Zone 1 et Zone 2, nous consulter pour délai d'approvisionnement - 📦 Epuisement/Stock depletion/Agotamiento del stock

Serrure de porte d'entrée / A COMMANDE ELECTRIQUE PROTECT



GARANTIE



X 3

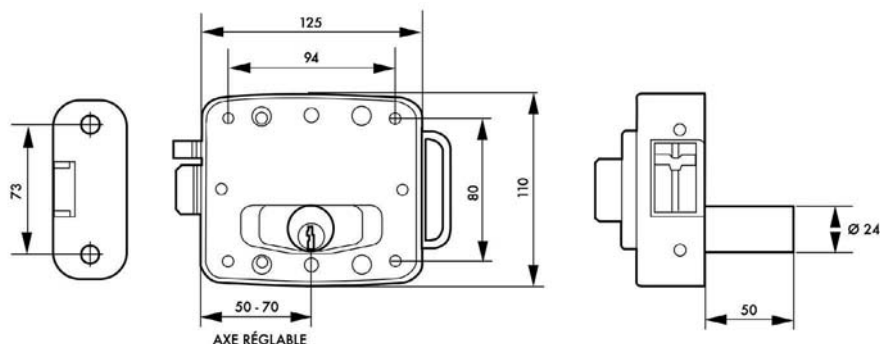

Description/Description/Descripción

Coffre et gâche acier embouti. Mécanisme réversible. Fonctionne avec courant basse tension 12 volts. Cylindre à goupilles Ø 24 longueur 50 mm. Axe réglable de 50 à 70 mm. 3 clés nickelées. Accessoires : support de fixation, plots de contact. Conforme aux exigences de la directive européenne de compatibilité électromagnétique 89/336/CEE.

Stamped steel case and striker. Reversible mechanism. Fitted with 12 V electric current. Pin cylinder Ø 24, 50 mm length. Adjustable backset from 50 to 70 mm. 3 nickel plated keys. Accessories : fitting holder, contactors. According to the european standard 89/336/CEE.

Caja y cerradero de acero embutido. Mecanismo reversible. Funciona con corriente de baja tensión 12 voltios. Cilindro de pasadores Ø 24 longitud 50 mm. Eje regulable de 50 a 70 mm. 3 llaves niqueladas. Accesorios: soporte de fijación, plots de contacto. Conforme a las exigencias de la directiva europea de compatibilidad electromagnética 89/336/CEE.

Finition/Finish/Acabado

Epoxy gris

Grey epoxy

Epoxi negro granitado

Versión/Option/Versión

à double cylindre

Double cylinder

De doble cilindro



Designation	Boite	Colis.	Prix	Sachet	Colis.	Prix	Brochable					Colis.	Prix
							France	Euro 1	Euro 2	Euro 3	Euro 4		
SERR. de sûreté à bouton poussoir et cylindre 50 mm réversible 3 clés	00005006	1	-	-	-	-	00505006	00593427	00592427	00594427	-	2	-
PLOTS de contact nylon pour serrure électrique	00006360	1	-	-	-	-	00106360	00193325	00192325	00194325	-	10	-

Non stocké/Non-stored/Producto no estocado - Sur stock Europe Zone 1 et Zone 2, nous consulter pour délai d'approvisionnement - Epuisement/Stock depletion/Agotamiento del stock

Serrure applique horizontale / A CYLINDRE RESIST



GARANTIE



X 3

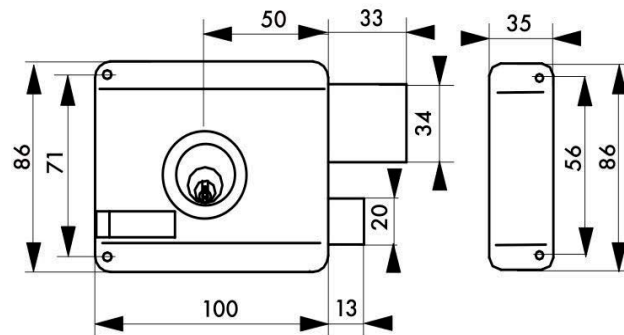

Description/Description/Descripción

Coffre et gâche acier embouti. Pêne laiton, demi-tour laiton. Mécanisme à 3 tours. Rappel du demi-tour par la clé. Double cylindre laiton 5 goupilles long. 45 mm. 3 clés laiton nickelé. Droite.

Pressed steel case and striker. Brass bolt. Brass latch. 3 latch mechanism. Drawback of the latch by key. Double brass cylinder 5 pins length 45 mm. 3 brass nickel plated keys. Right.

Caja y cerradero de acero embutido. Pestillo de latón. Media vuelta de latón. Mecanismo de 3 vueltas. Reposición de la media vuelta con la llave. Doble cilindro de latón 5 pasadores long. 45 mm. 3 llaves de latón niqueladas. Derecha.

Finition/Finish/Acabado

Epoxy marron
Brown epoxy
Epoxi marrón

Designation	Boite	Colis.	Prix	Sachet	Colis.	Prix	Brochable					Colis.	Prix
							France	Euro 1	Euro 2	Euro 3	Euro 4		
SERR. à DC à tirage 100 x 86 mm droite	00094347	1	-	-	-	-	-	-	-	-	-	5	-

⚠ Non stocké/Non-stored/Producto no estocado - ☑ Sur stock Europe Zone 1 et Zone 2, nous consulter pour délai d'approvisionnement - ☒ Epuisement/Stock depletion/Agotamiento del stock

Serrure applique horizontale / A CYLINDRE ET BOUTON A TIRAGE RESIST



GARANTIE



X 3

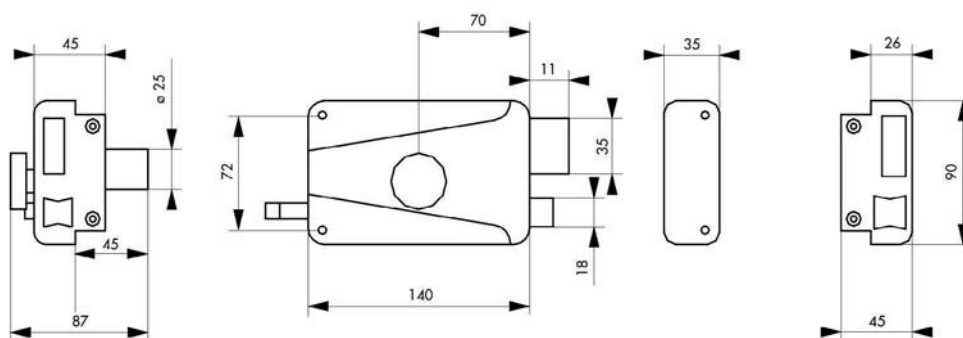

Description/Description/Descripción

Coffre et gâche acier embouti. Pêne et demi-tour acier zingué. Bouton intérieur laiton. Cylindre laiton à 5 goupilles longueur 45 mm. Mécanisme à 3 tours. Rappel du demi-tour par la clé. 3 clés nickelées. Entrée de cylindre laiton.

Pressed steel case and striker. Steel bolt and latch. Brass inside knob. Brass 5 pin cylinder 45 mm length. 3 latch mechanism. Drawback of the latch by key. 3 nickel plated keys. Brass cylinder hole plate.

Caja y cerradero de acero embutido. Pestillo y media vuelta de acero. Botón interior de latón. Cilindro de latón con 5 pasadores, long. 45 mm. Mecanismo de 3 vueltas. Reposición de la media vuelta con la llave. 3 llaves niqueladas. Entrada de cilindro de latón.

Finition/Finish/Acabado

Noir.

Black.

Negro.

Version/Option/Versión

Droite et gauche Pêne et demi-tour laiton sous conditionnement en boîte

Right and left hand

Derecha e izquierda



Designation	Boite	Colis.	Prix	Sachet	Colis.	Prix	Brochable					Colis.	Prix
							France	Euro 1	Euro 2	Euro 3	Euro 4		
SERRURE à cylindre et bouton à tirage 140 x 90 mm droite	00000114	1	-	-	-	-	00500114	-	-	-	-	2	-
SERRURE à cylindre et bouton à tirage 140 x 90 mm gauche	00000124	1	-	-	-	-	00500124	-	-	-	-	2	-

⊗ Non stocké/Non-stored/Producto no estocado - ⊠ Sur stock Europe Zone 1 et Zone 2, nous consulter pour délai d'approvisionnement - ⊞ Epuisement/Stock depletion/Agotamiento del stock

Serrure applique horizontale / A CYLINDRE RESIST



GARANTIE



X 3

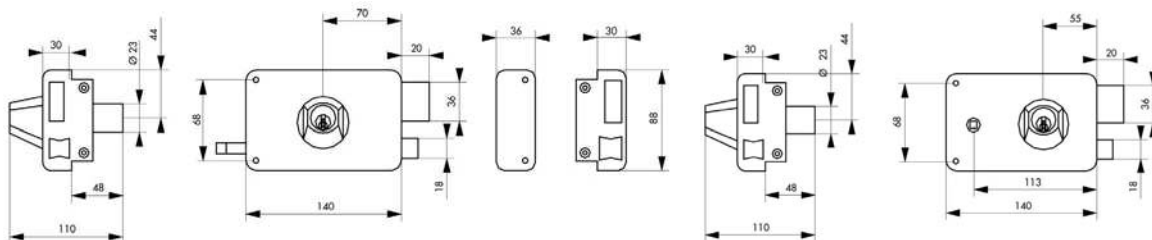

Description/Description/Descripción

Coffre et gâche acier embouti. Pêne et demi-tour acier zingué. Mécanisme à 2 tours. Rappel du demi-tour par la clé. Double cylindre laiton 5 goupilles long. 45 mm. Carré 6 mm. Entrée de cylindre et de fouillot laiton. 3 clés acier nickelé.

Pressed steel case and striker. Steel bolt and latch. Double latch mechanism. Drawback of the latch by key. Double brass cylinder 5 pins length 45 mm. Square 6 mm. Brass cylinder hole and follower plate. 3 nickel plated keys.
Caja y cerradero de acero embutido. Pestillo y media vuelta de acero. Mecanismo de 2 vueltas. Reposición de la media vuelta con la llave. Doble cilindro de latón 5 pasadores long. 45 mm. Cuadrado 6 mm. Entrada de cilindro y de la nuez de latón. 3 llaves niqueladas.

Finition/Finish/Acabado

Epoxy noir granité

Granited black epoxy

Epoxi negro granitado

Version/Option/Versión

A TIRAGE. Droite et gauche. Pêne et demi-tour laiton sous conditionnement en boîte. Protection contre l'arrachement du cylindre sous conditionnement coque.

Drawback pull. Right and left hand.

Con tirador. Derecha e izquierda

Designation	Boite	Colis.	Prix	Sachet	Colis.	Prix	Brochable					Colis.	Prix
							France	Euro 1	Euro 2	Euro 3	Euro 4		
SERR. à DC à tirage 140 x 88 mm droite	00000115	1	-	00900115	8	-	00500115	-	-	-	-	2	-
SERR. à DC à tirage 140 x 88 mm gauche	00000125	1	-	00900125	8	-	00500125	-	-	-	-	2	-
SERR. à DC à fouillot 140 x 88 mm droite	00000116	1	-	00900116	8	-	00500116	-	-	-	-	2	-
SERR. à DC à fouillot 140 x 88 mm gauche	00000126	1	-	00900126	8	-	00500126	-	-	-	-	2	-

⚠ Non stocké/Non-stored/Producto no estocado - 📦 Sur stock Europe Zone 1 et Zone 2, nous consulter pour délai d'approvisionnement - 📦 Epuisement/Stock depletion/Agotamiento del stock

Serrure applique verticale / A CYLINDRE

RESIST



GARANTIE



X 3

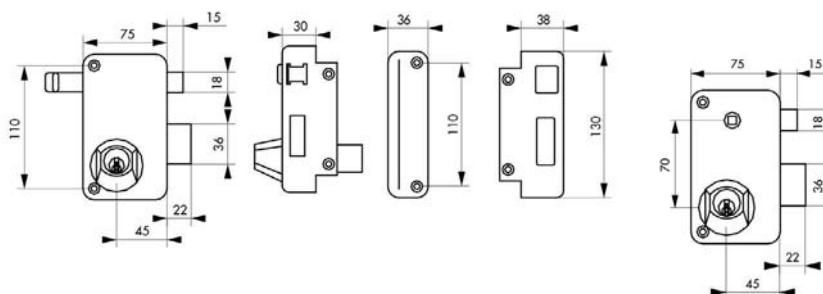

Description/Description/Descripción

Coffre et gâche acier embouti. Pêne et demi-tour acier zingué. Mécanisme à 2 tours. Rappel du demi-tour par la clé. Carré 7 mm. Entrée de cylindre laiton. Double cylindre laiton à 5 goupilles. Ø 2 mm long. 45 mm. 3 clés nickelées. Possibilité : Montage avec cylindre Transit 2 *Pressed steel case and striker. Steel bolt and latch. Double latch mechanism. Drawback of the latch by key. Square 7 mm. Brass cylinder hole plate. Brass 5 pin double cylinder. Ø 23 mm - 45 mm length. 3 keys.*

Caja y cerradero de acero embutido. Pestillo y media vuelta de acero. Mecanismo de 2 vueltas. Reposición de la media vuelta con la llave. Cuadrado 7 mm. Entrada de cilindro de latón. Doble cilindro de latón con 5 pasadores. Ø 23 mm, long. 45 mm. 3 llaves niqueladas.

Finition/Finish/Acabado

Epoxy noir granité
Granited black epoxy
Epoxi negro granitado

Version/Option/Versión

A TIRAGE. Pêne et demi-tour laiton sous conditionnement en boîte. Protection contre l'arrachement du cylindre sous conditionnement coque. *Drawback pull. Right and left hand*
Con tirador. Derecha e izquierda



Designation	Boite	Colis.	Prix	Sachet	Colis.	Prix	Brochable					Colis.	Prix
							France	Euro 1	Euro 2	Euro 3	Euro 4		
SERR. DC à tirage 75 x 130 mm droite	00000135	1	-	00900135	8	-	00300135	-	-	-	-	2	-
SERR. DC à tirage 75 x 130 mm gauche	00000145	1	-	00900145	8	-	00300145	-	-	-	-	2	-
SERR. DC à fouillot 75 x 130 mm droite	00000136	1	-	00900136	8	-	00300136	-	-	-	-	2	-
SERR. DC à fouillot 75 x 130 mm gauche	00000146	1	-	00900146	8	-	00300146	-	-	-	-	2	-

⊗ Non stocké/Non-stored/Producto no estocado - ⊠ Sur stock Europe Zone 1 et Zone 2, nous consulter pour délai d'approvisionnement - ⊞ Epuisement/Stock depletion/Agotamiento del stock

Serrure applique horizontale / POUR CYLINDRE PROFILE ECO



GARANTIE

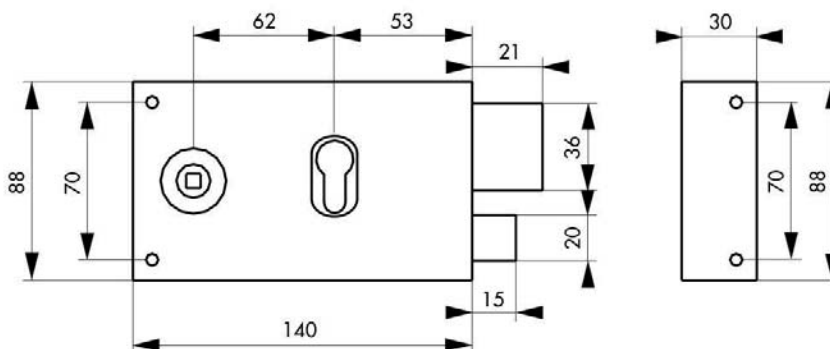

Description/Description/Descripción

Coffre et gâche acier cambré. Pêne acier. Demi-tour acier. Mécanisme à 2 tours. Carré 6 mm.
Cambered steel case and striker. Steel bolt. Steel latch. Double latch mechanism. Square 6 mm.
 Caja y cerradero de acero curvado. Pestillo de acero. Media vuelta de acero. Mecanismo de 2 vueltas. Cuadrado 6 mm.

Finition/Finish/Acabado

Epoxy noir granité
Granited black epoxy
 Epoxi negro granitado

Version/Option/Versión

Droite et gauche
Right and left hand
 Derecha e izquierda

Designation	Boite	Colis.	Prix	Sachet	Colis.	Prix	Brochable					Colis.	Prix
							France	Euro 1	Euro 2	Euro 3	Euro 4		
BOITIER CP à fouillot 140 x 88 mm droite	-	-	-	00908766	10	-	00508766	-	-	-	-	2	-
BOITIER CP à fouillot 140 x 88 mm gauche	-	-	-	00908776	10	-	00508776	-	-	-	-	2	-

⚠ Non stocké/Non-stored/Producto no estocado - 📦 Sur stock Europe Zone 1 et Zone 2, nous consulter pour délai d'approvisionnement - 📦 Epuisement/Stock depletion/Agotamiento del stock

Serrure applique verticale / POUR CYLINDRE PROFILE ECO



GARANTIE

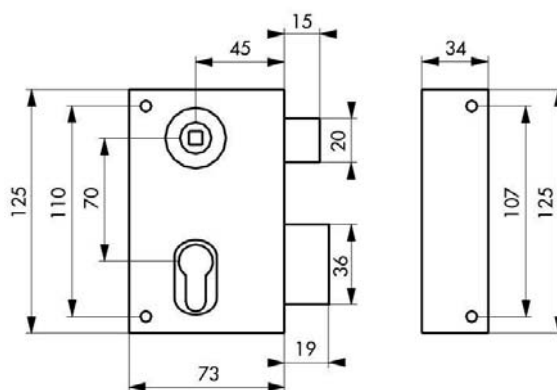

Description/Description/Descripción

Coffre et gâche acier cambré. Pêne acier. Demi-tour acier. Mécanisme à 2 tours. Carré 7 mm.
Cambered steel case and striker. Steel bolt. Steel latch. Double latch mechanism. Square 7 mm.
 Caja y cerradero de acero, curvado. Pestillo de acero. Media vuelta de acero. Mecanismo de 2 vueltas. Cuadrado 7 mm.

Finition/Finish/Acabado

Epoxy noir granité
Granited black epoxy
 Epoxi negro granitado

Versión/Option/Versión

Droite et gauche
Right and left hand
 Derecha e izquierda

Designation	Boite	Colis.	Prix	Sachet	Colis.	Prix	Brochable					Colis.	Prix
							France	Euro 1	Euro 2	Euro 3	Euro 4		
BOITIER CP 73 x 125 mm droite	-	-	-	00908816	10	-	00308816	-	-	-	-	2	-
BOITIER CP 73 x 125 mm gauche	-	-	-	00908826	10	-	00308826	-	-	-	-	2	-

⚠ Non stocké/Non-stored/Producto no estocado - 📦 Sur stock Europe Zone 1 et Zone 2, nous consulter pour délai d'approvisionnement - ⚠ Epuisement/Stock depletion/Agotamiento del stock

Serrure applique horizontale / POUR CYLINDRE PORFILE PROTECT



GARANTIE

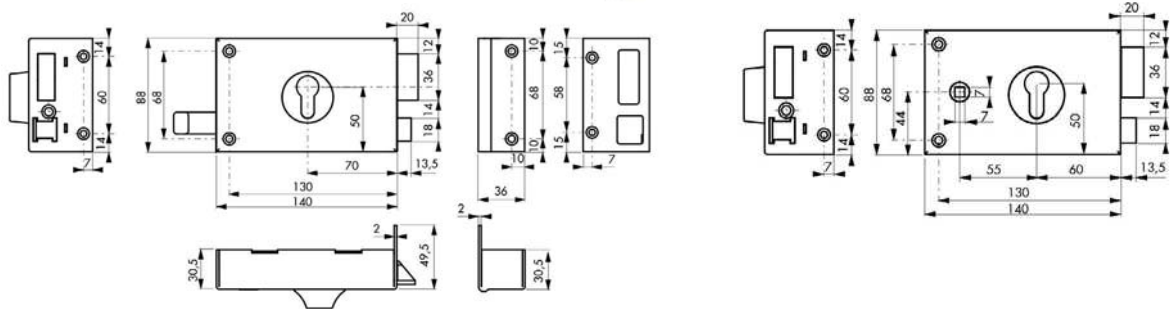

Description/Description/Descripción

Coffre et gâche acier cambré. Pêne acier zingué. Demi-tour acier zingué. Mécanisme à 2 tours. Rappel du demi-tour par la clé. Carré 7 mm.

Cambered steel case and striker. Zinc plated steel bolt. Zinc plated steel latch. Double latch mechanism. Drawback of the latch by key. Square 7 mm.

Caja y cerradero de acero curvado. Pestillo de acero cincado. Media vuelta de acero cincado. Mecanismo de 2 vueltas. Reposición de la media vuelta con la llave. Cuadrado 7 mm.

Finition/Finish/Acabado

Epoxy noir granité

Granited black epoxy

Epoxi negro granitado

Versión/Option/Versión

Tirage. Droite et gauche.

Drawback pull. Right and left hand.

Con tirador. Derecha e izquierda.

Designation	Boite	Colis.	Prix	Sachet	Colis.	Prix	Brochable					Colis.	Prix
							France	Euro 1	Euro 2	Euro 3	Euro 4		
BOITIER CP à tirage 140 x 88 mm droite	00086010	1	-	-	-	-	-	-	-	-	-	-	-
BOITIER CP à tirage 140 x 88 mm gauche	00086020	1	-	-	-	-	-	-	-	-	-	-	-
BOITIER CP à fouillot 140 x 88 mm droite	00086110	1	-	-	-	-	-	-	-	-	-	-	-
BOITIER CP à fouillot 140 x 88 mm gauche	00086120	1	-	-	-	-	-	-	-	-	-	-	-
Boitier CP à tirage 140x88 mm noir droite «poussant»	PS086010 NS	1	-	-	-	-	-	-	-	-	-	-	-
Boitier CP à tirage 140x88 mm noir gauche «poussant»	PS086020 NS	1	-	-	-	-	-	-	-	-	-	-	-
Boitier CP à fouillot 140x88 mm noir droite «poussant»	PS086110 NS	1	-	-	-	-	-	-	-	-	-	-	-
Boitier CP à fouillot 140x88 mm noir gauche «poussant»	PS086120 NS	1	-	-	-	-	-	-	-	-	-	-	-

NS Non stocké/Non-stored/Producto no estocado - ☐ Sur stock Europe Zone 1 et Zone 2, nous consulter pour délai d'approvisionnement - ☒ Epuisement/Stock depletion/Agotamiento del stock

Serrure applique verticale / POUR CYLINDRE PROFILE PROTECT



GARANTIE

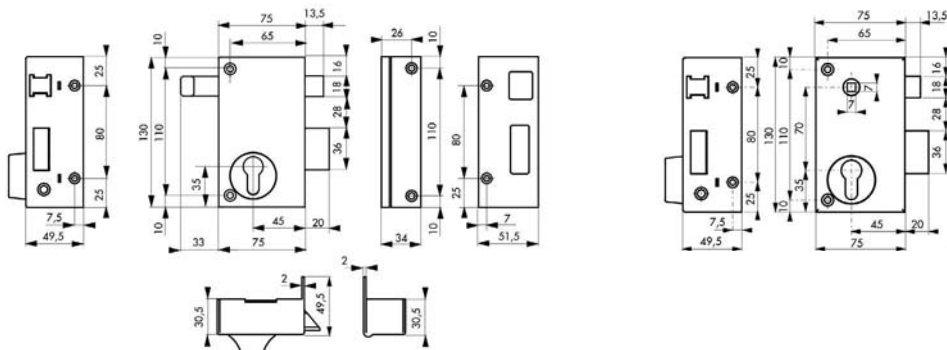

Description/Description/Descripción

Coffre et gâche acier cambré. Pêne acier zingué. Demi-tour acier zingué. Mécanisme à 2 tours. Carré 7 mm.
Cambered steel case and striker. Zinc plated steel bolt. Zinc plated steel latch. Double latch mechanism. Square 7 mm.

Caja y cerradero de acero curvado. Pestillo de acero cincado. Media vuelta de acero cincado. Mecanismo de 2 vueltas. Cuadrado 7 mm.

Finition/Finish/Acabado

Epoxy noir granité
Granited black epoxy
Epoxi negro granitado

Version/Option/Versión

Tirage. Droite et gauche.
Drawback pull. Right and left hand.
Con tirador. Derecha e izquierda.



Designation	Boite	Colis.	Prix	Sachet	Colis.	Prix	Brochable					Colis.	Prix
							France	Euro 1	Euro 2	Euro 3	Euro 4		
BOITIER CP à tirage 75 x 130 mm droite	00089010	1	-	-	-	-	-	-	-	-	-	-	-
BOITIER CP à tirage 75 x 130 mm gauche	00089020	1	-	-	-	-	-	-	-	-	-	-	-
BOITIER CP à fouillot 75 x 130 mm droite	00089110	1	-	-	-	-	-	-	-	-	-	-	-
BOITIER CP à fouillot 75 x 130 mm gauche	00089120	1	-	-	-	-	-	-	-	-	-	-	-
Boitier CP à tirage 75x130 mm noir droite «poussant»	PS089010 NS	1	-	-	-	-	-	-	-	-	-	-	-
Boitier CP à tirage 75x130 mm noir gauche «poussant»	PS089020 NS	1	-	-	-	-	-	-	-	-	-	-	-
Boitier CP à fouillot 75x130 mm noir droite «poussant»	PS089110 NS	1	-	-	-	-	-	-	-	-	-	-	-
Boitier CP à fouillot 75x130 mm noir gauche «poussant»	PS089120 NS	1	-	-	-	-	-	-	-	-	-	-	-

NS Non stocké/Non-stored/Producto no estocado - Sur stock Europe Zone 1 et Zone 2, nous consulter pour délai d'approvisionnement - E Epuisement/Stock depletion/Agotamiento del stock

Serrure applique verticale / «ALSACE» POUR CYLINDRE PROTECT



GARANTIE

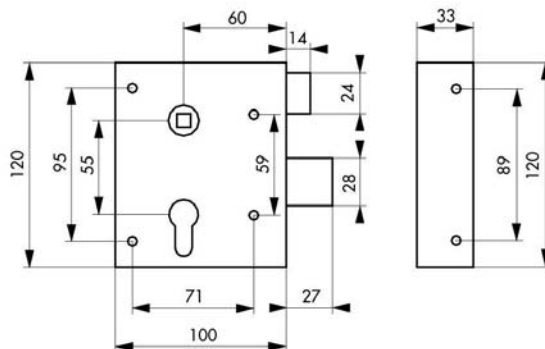

Description/Description/Descripción

Coffre et gâche acier cambré. Pêne et demi-tour acier.
Réversible tirant ou poussant. Mécanisme à 2 tours.
Carré 8 mm. Pour cylindre profilé européen. 30 x 60 mm,
pour porte de 45 mm.

*Cambered steel case and striker. Steel bolt and latch.
Double latching mechanism. Square 8 mm. For european
profile cylinder. 30 x 60 mm for 45 mm. thickness door.*

Caja y cerradero de acero curvado. Pestillo y media
vuelta de acero. Mecanismo de 2 vueltas. Cuadrado 8
mm. Para cilindro perfilado europeo. 30 x 60 mm, para
puerta de 45 mm.

Finition/Finish/Acabado

Zingué
Zinc coated
Cincado

Designation	Boite	Colis.	Prix	Sachet	Colis.	Prix	Brochable					Colis.	Prix
							France	Euro 1	Euro 2	Euro 3	Euro 4		
BOIT. SERR. de sûreté à cyl. prof. à fouillot 100 x117 mm A60 révers. tirant ou poussant	00010503	1	-	00910503	10	-	00310503	00393235	00392235	00394235	-	5	-

Non stocké/Non-stored/Producto no estocado - Sur stock Europe Zone 1 et Zone 2, nous consulter pour délai d'approvisionnement - Epuisement/Stock depletion/Agotamiento del stock

Serrure applique horizontale / POUR CYLINDRE PROFILE RESIST



GARANTIE



Axe réglable de 50 à 60mm
et entr'axe réglable de 108 à 120 mm

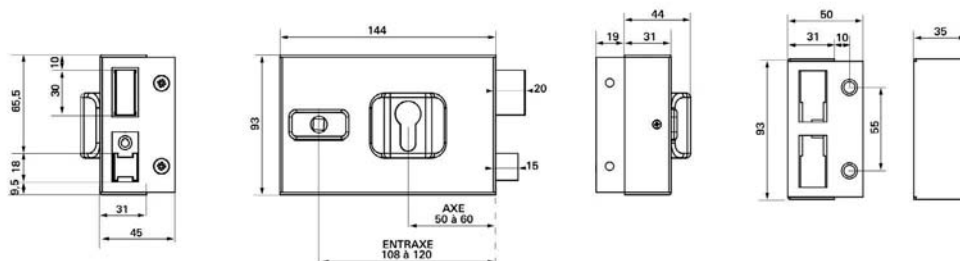

Description/Description/Descripción

Coffre de 144 x93mm en acier cambré. Peinture époxy noir granité. Pêne dormant en acier nickelé, Pêne demi tour en zamak nickelé. Fouillot carré 7mm en zamak. Axe réglable de 50 à 60 mm. Entraxe réglable de 108 à 120 mm. Cabochon CP et fouillot en polyamide noir. Plaque Support de fixation en acier galvanisé. Cette serrure s'adapte au sens de porte (Droite / Gauche / Tirant / Poussant).

Cambered steel case 144x93 mm. Black epoxy. Deadbolt out of nickel-plated steel, latch bolt out of nickel-plated zinc die-cast. Square nut 7 mm out of zinc die-cast. Adjustable axis 50 to 60 mm. Adjustable distance in between 108 to 120 mm. Cabochon out of CP and nut out of black polyamide coating. Mounting plaque in galvanized steel. This lock adapts itself to the direction of the door opening (Right/Left/Pulling/Pushing).

Caja de 144x93 en acero moldeado .pintura epoxy negra , pasador en acero niquelado , pasador de media vuleta en zamak niquelado .Cuadradillo de 7mm en zamak . Eje regulable de 50 a 60mm .Entrejes de 108 a 120mm Tapa de CP y manilla de poliamida negro .Placa soporte de fijacion en acero galvanizado . Esta cerrura se adapta al sentido de la puerta (derecha izquierda de tirar o de empujar).

Finition/Finish/Acabado

Epoxy noir granité
Black epoxy
Epoxi negro granitado

Designation	Boite	Colis.	Prix	Sachet	Colis.	Prix	Brochable					Colis.	Prix
							France	Euro 1	Euro 2	Euro 3	Euro 4		
Boitier de serrure UNIVERSELLE 144 x 93mm axe et entraxe réglable réversible	00084110	1	-	-	-	-	00584110	-	-	-	-	5	-

Non stocké/Non-stored/Producto no estocado - Sur stock Europe Zone 1 et Zone 2, nous consulter pour délai d'approvisionnement - Epuement/Stock depletion/Agotamiento del stock

Serrure applique horizontale / POUR CYLINDRE PROFILE RESIST



GARANTIE

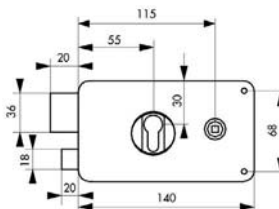
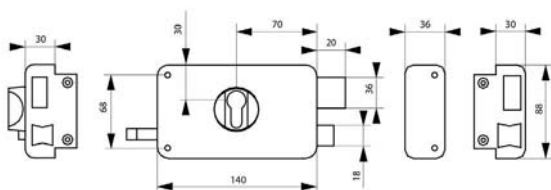

Description/Description/Descripción

Coffre et gâche acier emboutis. Pêne et demi-tour acier zingué. Mécanisme à 2 tours. Rappel du demi-tour par la clé. Carré 6 mm. Entrée de cylindre et de fouillot laiton. Pour cylindre profilé européen. 30 x 60 mm, pour porte de 45 mm.

Pressed steel case and striker. Steel bolt and latch. Double latch mechanism. Drawback of the latch by key. Square 6 mm. Brass cylinder hole and follower plate. For european profile cylinder 30 x 60 mm, for 45 mm thickness door.

Caja y cerradero de acero embudido. Pestillo y media vuelta de acero. Mecanismo de 2 vueltas. Reposición de la media vuelta con la llave. Cuadrado 6 mm. Entrada de cilindro y de la nuez de latón. Para cilindro perfilado europeo. 30 x 60 mm, para puerta de 45 mm.

Finition/Finish/Acabado

Epoxy noir granité

Granited black epoxy

Epoxi negro granitado

Version/Option/Versión

A TIRAGE. Serrure en poussant. Droite et gauche.

Droite et gauche poussant. Pêne et demi-tour laiton sous conditionnement en boîte. Axe 60 mm pour remplacement LAP sans pêne et demi-tour en saillie de 5 mm.

Drawback pull. Push lock. Right and left hand. Push right and left hand. Axis 60 mm.

Con tirador. Cerradura empujando. Derecha e izquierda. Empujaando derecha e izquierda. Eje 60 mm.

Designation	Boite	Colis.	Prix	Sachet	Colis.	Prix	Brochable					Colis.	Prix
							France	Euro 1	Euro 2	Euro 3	Euro 4		
BOITIER à tirage 140 x 88 mm droite	00019766	1	-	00919766	10	-	00519766	-	-	-	-	2	-
BOITIER à tirage 140 x 88 mm gauche	00019776	1	-	00919776	10	-	00519776	-	-	-	-	2	-
BOIT. à fouillot 140 x 88 mm drte axe 55	00009766	1	-	00909766	10	-	00509766	-	-	-	-	2	-
BOIT. à fouillot 140 x 88 mm gche axe 55	00009776	1	-	00909776	10	-	00509776	-	-	-	-	2	-
BOIT. à fouillot 140 x 88 mm drte "poussant"	00099766	1	-	-	-	-	-	-	-	-	-	-	-
BOIT. à fouillot 140 x 88 mm gche "poussant"	00099776	1	-	-	-	-	-	-	-	-	-	-	-
BOIT. à cyl. prof. 140 x 88 mm axe 60 droite	00009666	1	-	00909666	-	-	-	-	-	-	-	-	-
BOIT. à cyl. prof. 140 x 88 mm axe 60 gauche	00009676	1	-	00909676	-	-	-	-	-	-	-	-	-
BOIT. à cyl. prof. 140 x 88 mm axe 60 droite "poussant"	00009966	1	-	-	-	-	-	-	-	-	-	-	-
BOIT. à cyl. prof. 140 x 88 mm axe 60 gauche "poussant"	00009976	1	-	-	-	-	-	-	-	-	-	-	-

⚠ Non stocké/Non-stored/Producto no estocado - 📦 Sur stock Europe Zone 1 et Zone 2, nous consulter pour délai d'approvisionnement - 📦 Epuisement/Stock depletion/Agotamiento del stock

Serrure applique verticale / POUR CYLINDRE PROFILE RESIST



GARANTIE

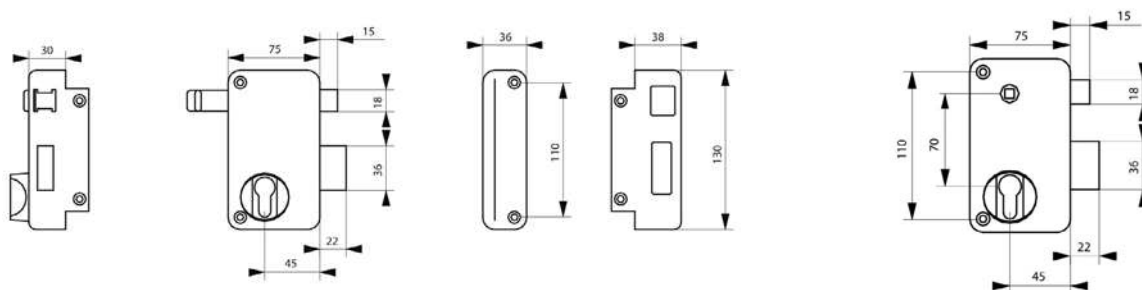

Description/Description/Descripción

Coffre et gâche acier emboutis. Pêne et demi-tour acier zingué. Mécanisme à 2 tours. Rappel du demi-tour par la clé. Carré 7 mm. Entrée de cylindre laiton. Pour cylindre profilé européen 30 x 60 mm, pour porte de 45 mm.

Pressed steel case and striker. Steel bolt and latch. Double latch mechanism. Drawback of the latch by key. Square 7 mm. Brass cylinder hole plate. For european profile cylinder 30 x 60 mm for 45 mm thickness door.

Caja y cerradero de acero embutido. Pestillo y media vuelta de acero. Mecanismo de 2 vueltas. Reposición de la media vuelta con la llave. Cuadrado 7 mm. Entrada de cilindro de latón. Para cilindro perfilado europeo. 30 x 60 mm, para puerta de 45 mm.

Finition/Finish/Acabado

Epoxy noir granité

Granited black epoxy

Epoxi negro granitado

Version/Option/Versión

A TIRAGE. Serrure en "poussant". Droite et gauche. Pêne et demi-tour laiton sous conditionnement en boîte

Drawback pull. Push lock. Right and left hand.

Con tirador. Derecha e izquierda. Cerradura "empujando".



Designation	Boite	Colis.	Prix	Sachet	Colis.	Prix	Brochable					Colis.	Prix
							France	Euro 1	Euro 2	Euro 3	Euro 4		
BOITIER à tirage 75 x 130 mm droite	00009813	1	-	00909813	10	-	-	-	-	-	-	-	-
BOITIER à tirage 75 x 130 mm gauche	00009823	1	-	00909823	10	-	-	-	-	-	-	-	-
BOITIER à fouillot 75 x 130 mm droite	00009816	1	-	00909816	10	-	00309816	-	-	-	-	2	-
BOITIER à fouillot 75 x 130 mm gauche	00009826	1	-	00909826	10	-	00309826	-	-	-	-	2	-
BOIT. à fouillot 75 x 130 mm drte «poussant»	00099816	1	-	-	-	-	-	-	-	-	-	-	-
BOIT. à fouillot 75 x 130 mm gche «poussant»	00099826	1	-	-	-	-	-	-	-	-	-	-	-

⊗ Non stocké/Non-stored/Producto no estocado - ⊗ Sur stock Europe Zone 1 et Zone 2, nous consulter pour délai d'approvisionnement - ⊗ Epuisement/Stock depletion/Agotamiento del stock

Serrure applique horizontale / CYLINDRE RIM RESIST

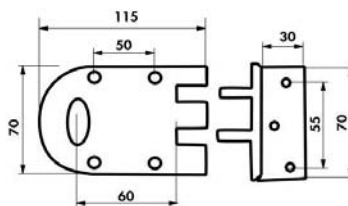

GARANTIE



X 3

Description/Description/Descripción

Coffre et gâche acier cambré. Pêne acier. Réversible. 3 clés.

Cambered steel case and striker. Steel bolt. reversible. 3 keys.

Caja y cerradero de acero curvado. Pestillo de acero. Reversible. 3 llaves.

Finition/Finish/Acabado

Doré

Gold

Dorado

Designation	Boite	Colis.	Prix	Sachet	Colis.	Prix	Brochable					Colis.	Prix
							France	Euro 1	Euro 2	Euro 3	Euro 4		
SERRURE 115 x 70 mm 3 clés	-	-	-	-	-	-	-	00593248 NS	00592248 NS	-	-	5	-

Serrure tubulaire / A CYLINDRE PROTECT

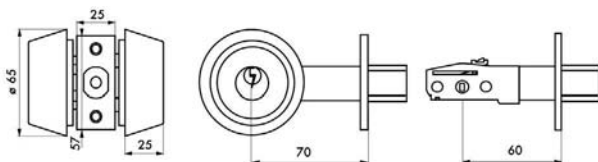

GARANTIE



X 3

Description/Description/Descripción

Boîtier extérieur avec cylindre de sûreté à goupilles.
Boîtier intérieur avec bouton de condamnation. Pêne avec dispositif antisaiage et tête rectangulaire. Gâche plate. Axe réglable 60/70mm. 3 clés en acier nickelé.

Outside case with safety pin cylinder. Inside case with locking knob. Bolt with antisawing device and rectangular forend. Flat striker. Backset 60/70mm. 3 nickel plated steel keys.

Caja exterior con cilindro de seguridad de pasadores.

Caja interior con botón de condenación. Pestillo con dispositivo antiserrado y cabeza rectangular. Cerradero plano. Eje 60/70mm. 3 llaves de acero niquelado.

Finition/Finish/Acabado

Chromé mat. Laiton poli.

Dull chrome plated. Polished brass.

Cromado mate. Latón pulido.

Versión/Option/Versión

Boîtier axe à 60 mm

60 mm backset latch bolt

Caja eje a 60 mm

Utilisation/Use/Utilización

Porte extérieure ép. 35 à 45 mm

Entrance door 35 to 45 mm thickness

Puertas exteriores de 35 a 45 mm de espesor

Designation	Boite	Colis.	Prix	Sachet	Colis.	Prix	Brochable					Colis.	Prix
							France	Euro 1	Euro 2	Euro 3	Euro 4		
VERROU bouton et cylindre chromé mat 3 clés-axe réglable 60/70mm	-	-	-	00900516	5	-	00500516	-	00592432 NS	-	-	5	-
VERROU bouton et cylindre doré 3 clés - axe réglable 60/70mm	-	-	-	00901516	5	-	00501516	-	00592433 NS	-	-	5	-
VERROU double entrée chromé mat 3 clés - axe réglable 60/70mm	-	-	-	00900517	5	-	00500517	-	-	-	-	5	-
VERROU double entrée doré 3 clés 70 - axe réglable 60/70mm	-	-	-	00901517	5	-	00501517	-	-	-	-	5	-

NS Non stocké/Non-stored/Producto no estocado - M Sur stock Europe Zone 1 et Zone 2, nous consulter pour délai d'approvisionnement - E Epuisement/Stock depletion/Agotamiento del stock

Serrure tubulaire / A CYLINDRE

PROTECT



GARANTIE



X 3

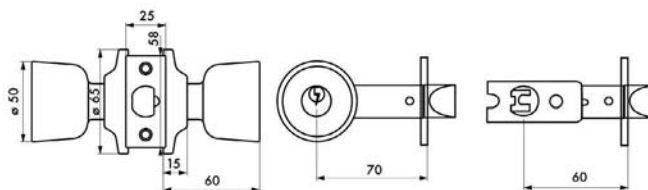

Description/Description/Descripción

Pommeau extérieur en acier embouti avec cylindre de sûreté à goupilles. Pommeau intérieur en acier embouti avec bouton de condamnation. Pêne 1/2 tour réversible avec dispositif de sécurité et têtère rectangulaire. Gâche plate. Axe réglable 60/70mm. 3 clés en acier nickelé.
Stamped steel outside knob with safety pin cylinder. Stamped steel inside knob with locking knob. Reversible bolt with security device and rectangular forend. Flat striker. Backset 60/70mm. 3 nickel plated steel keys.
 Pomo exterior de acero embutido con cilindro de seguridad de pasadores. Pomo interior de acero embutido con botón de condenación. Pestillo media vuelta reversible con dispositivo de seguridad y cabeza rectangular. Cerradero plano. Eje 60/70mm. 3 llaves de acero niquelado.

Finition/Finish/Acabado

Chromé mat. Laiton poli.
Dull chrome plated. Polished brass.
 Cromado mate. Latón pulido

Version/Option/Versión

Boîtier axe à 60 mm
 60 mm backset latch bolt
 Caja eje a 60 mm

Utilisation/Use/Utilización

Porte extérieure ép. 35 à 50 mm
Entrance door 35 to 50 mm thickness
 Puertas exteriores de 35 a 50 mm de espesor



Designation	Boite	Colis.	Prix	Sachet	Colis.	Prix	Brochable					Colis.	Prix
							France	Euro 1	Euro 2	Euro 3	Euro 4		
SERRURE à clé et condamnation chromé mat 3 clés axe réglable 60/70 mm	-	-	-	00900560	5	-	00500560	-	00592430 <small>NS</small>	-	-	5	-
SERRURE à clé et condamnation doré 3 clés axe réglable 60/70 mm	-	-	-	00901560	5	-	00501560	-	00592431 <small>NS</small>	-	-	5	-
SERRURE double entrée chromé mat 3 clés axe réglable 60/70 mm	-	-	-	00900567	5	-	00500567	-	-	-	-	5	-
SERRURE double entrée doré 3 clés axe réglable 60/70 mm	-	-	-	00901567	5	-	00501567	-	-	-	-	5	-

Non stocké/Non-stored/Producto no estocado - Sur stock Europe Zone 1 et Zone 2, nous consulter pour délai d'approvisionnement - Epuisement/Stock depletion/Agotamiento del stock

Serrure 3 points / HORGА CR

PROTECT

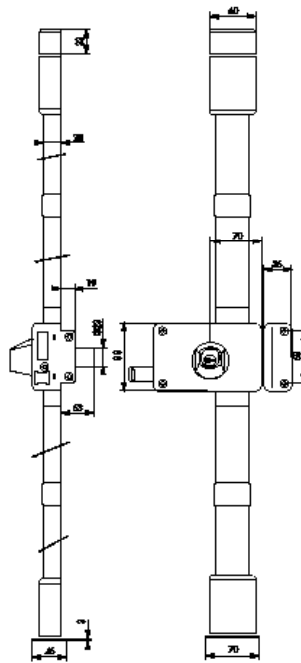

GARANTIE



X 4

Description/Description/Descripción

Boîtier en acier embouti ép. 2 /10ème. Coffre de 140 x 88 mm. Tringles standard permettant une condamnation de porte de 1,65 m à 2 2 m. Mécanisme intérieur type équerre permettant la manœuvre du 1/2 tour avec la clé, de l'intérieur comme de l'extérieur. Pêne dormant et 1/2 tour en laiton massif. Pêne haut et bas en acier Ø 16 mm sur tringles plates en acier permettant un ajustement très précis à la longueur désirée et ne nécessitant aucune recoupe. Gâche avec tête de haute résistance. Cache-tringles, guides et gâches de pènes haut et bas en acier ne laissant apparaître aucune vis de fixation. Enjoliveur de cylindre côté intérieur. Carré 6 mm. Le montage des serrures ne nécessite pas d'entaillage spécifique de la porte. Cylindre rond HG5 Double cylindre laiton Ø 2 mm, longueur 60 mm. Mécanisme à 5 goupilles. 4 clés en acier nickelé. Cylindre rond Transit 2 double cylindre laiton Ø 2 mm, longueur 60 mm. Mécanisme à 8 goupilles protégé contre le crochetage. Protection contre le perçage par 1ère goupille + poussoir en acier trempé. 4 clés plates réversibles en laiton nickelé avec carte de propriété. Options : Jeu de tringles grande hauteur permettant un verrouillage jusqu'à 3 m. Bouton double. Stamped steel case (20/10 th). 140 x 88 mm. Standard rods for bolting a door from 1,65 m to 2,25 m. Internal square mechanism allowing the use of 1/2 turn with the key from inside as well as from outside. Brass dead bolt and latch bolt. Steel up and down bolts. Ø 16 mm with steel rods which can be adjusted at the good. height without cutting rods. High resistant square striker. Hardened rods protection, guide and strikers for up and down bolts in steel. Hub cap of inside cylinder. Square 6 mm. Lock assembling without cutting the door. Accessories : Rods kit for a maximum 3 m high door. Finger plate outside handle. Double knob. Hinge protection. Round cylinder HG5 Brass cylinder Ø 23 mm, long. 60 mm. 5 pin mechanism. 4 nickel plated keys. Round cylinder TRANSIT 2 Brass cylinder Ø 23 mm, long. 60 mm. 8 pin mechanism protected against picking.

Protection against drilling by hardened steel pins. 4 reversible brass nickel plated keys with a personal security card for key copie.

aja de acero embutido de 20/10 de espesor. Caja de 140 x 88 mm. Trancas estándar que permiten la condenación de una puerta de 1,65 a 2,25 m. Mecanismo interior de tipo. escuadra que permite maniobrar la media vuelta con la llave, tanto desde el interior como desde el exterior. Pestillo durmiente y media vuelta de latón macizo. Pestillo alto y bajo de acero. Ø 16 mm, en trancas de acero que permiten un ajuste muy preciso con la longitud. deseada y no necesitan ningún corte. Cerradero de escuadra de alta resistencia. Cubretrancas, guías y cerraderos de pestillos alto y bajo de acero que ocultan los tornillos de fijación. Embellecedor de cilindro por el lado interior. Cuadrado 6 mm. El montaje de las cerraduras no precisa una entalladura específica de la puerta. Accesorios: Juego de trancas de gran altura que permiten un cierre de hasta 3 m. Botón doble. Protector de goznes. Cilindro redondo HG5 Cilindro de latón Ø 23 mm, long. 60 mm. Mecanismo de 5 pistones. 4 llaves de acero niquelado. Cilindro redondo TRANSIT 2 Cilindro de latón Ø 23 mm, long. 60 mm. Mecanismo de 8 pistones contra la recogiendo. Protección contra el taladrado por medio de un pasador de acero templado. 4 llaves planas reversibles de latón niquelado con título de propiedad que permite su reproducción en fábrica.

Finition/Finish/Acabado

Epoxy marron ou blanc

Brown or white epoxy

Epoxi marrón o blanco

Versión/Option/Versión

Droite ou gauche. A TIRAGE ou à fouillot. Avec ou sans cylindre.

Right or left hand. Drawback pull or follwer type. With or without cylinder.

Derecha o izquierda. De tirador o de nuez. Con o sin cilindro.

Serrure 3 points / HORGА CR

PROTECT

Designation	Boite	Colis.	Prix	Sachet	Colis.	Prix	Brochable					Colis.	Prix
							France	Euro 1	Euro 2	Euro 3	Euro 4		
SERR. HORGА marron CR HG5 à tirage 140 x 88 mm drte 4 clés	00037315	1	-	-	-	-	-	-	-	-	-	-	-
SERR. HORGА marron CR HG5 à tirage 140 x 88 mm gche 4 clés	00037325	1	-	-	-	-	-	-	-	-	-	-	-
SERR. HORGА blanche CR HG5 à tirage 140 x 88 mm drte 4 clés	00038315 <small>NS</small>	1	-	-	-	-	-	-	-	-	-	-	-
SERR. HORGА blanche CR HG5 à tirage 140 x 88 mm gche 4 clés	00038325 <small>NS</small>	1	-	-	-	-	-	-	-	-	-	-	-
SERR. HORGА marron CR HG5 à fouillot 140 x 88 mm drte 4 clés	00037316	1	-	-	-	-	-	-	-	-	-	-	-
SERR. HORGА marron CR HG5 à fouillot 140 x 88 mm gche 4 clés	00037326	1	-	-	-	-	-	-	-	-	-	-	-
SERR. HORGА blanche CR HG5 à fouillot 140 x 88 mm drte 4 clés	00038316	1	-	-	-	-	-	-	-	-	-	-	-
SERR. HORGА blanche CR HG5 à fouillot 140 x 88 mm gche 4 clés	00038326	1	-	-	-	-	-	-	-	-	-	-	-
SERR. HORGА marron CR TRANSIT 2 à tirage 140 x 88 mm drte 4 clés	00057315 <small>NS</small>	1	-	-	-	-	-	-	-	-	-	-	-
SERR. HORGА marron CR TRANSIT 2 à tirage 140 x 88 mm gche 4 clés	00057325	1	-	-	-	-	-	-	-	-	-	-	-
SERR. HORGА blanche CR TRANSIT 2 à tirage 140 x 88 mm drte 4 clés	00058315	1	-	-	-	-	-	-	-	-	-	-	-
SERR. HORGА blanche CR TRANSIT 2 à tirage 140 x 88 mm gche 4 clés	00058325	1	-	-	-	-	-	-	-	-	-	-	-
SERR. HORGА marron CR TRANSIT 2 à fouillot 140 x 88 mm drte 4 clés	00057316 <small>NS</small>	1	-	-	-	-	-	-	-	-	-	-	-
SERR. HORGА marron CR TRANSIT 2 à fouillot 140 x 88 mm gche 4 clés	00057326 <small>NS</small>	1	-	-	-	-	-	-	-	-	-	-	-
SERR. HORGА blanche CR TRANSIT 2 à fouillot 140 x 88 mm drte 4 clés	00058316	1	-	-	-	-	-	-	-	-	-	-	-
SERR. HORGА blanche CR TRANSIT 2 à fouillot 140 x 88 mm gche 4 clés	00058326	1	-	-	-	-	-	-	-	-	-	-	-
BOUTON DOUBLE rond laqué marron 1 portée carré 6 longueur 100 mm	00000492	1	-	-	-	-	-	-	-	-	-	-	-
BOUTON DOUBLE rond laqué blanc 1 portée carré 6 longueur 100 mm	00000493	1	-	-	-	-	-	-	-	-	-	-	-
KIT TRINGLE PLATE marron pour hauteur porte 3,00 m	00032320	1	-	-	-	-	-	-	-	-	-	-	-
KIT TRINGLE PLATE blanc pour hauteur porte 3,00 m	00032321	1	-	-	-	-	-	-	-	-	-	-	-
PROTEGE GONDS la paire	00025000	10	-	-	-	-	00225000	-	-	-	-	10	-

NS Non stocké/Non-stored/Productos no estocado - ■ Sur stock Europe Zone 1 et Zone 2, nous consulter pour délai d'approvisionnement - E Epuement/Stock depletion/Agotamiento del stock



Serrure 3 points / TARGA CR

ECO



GARANTIE



X 4

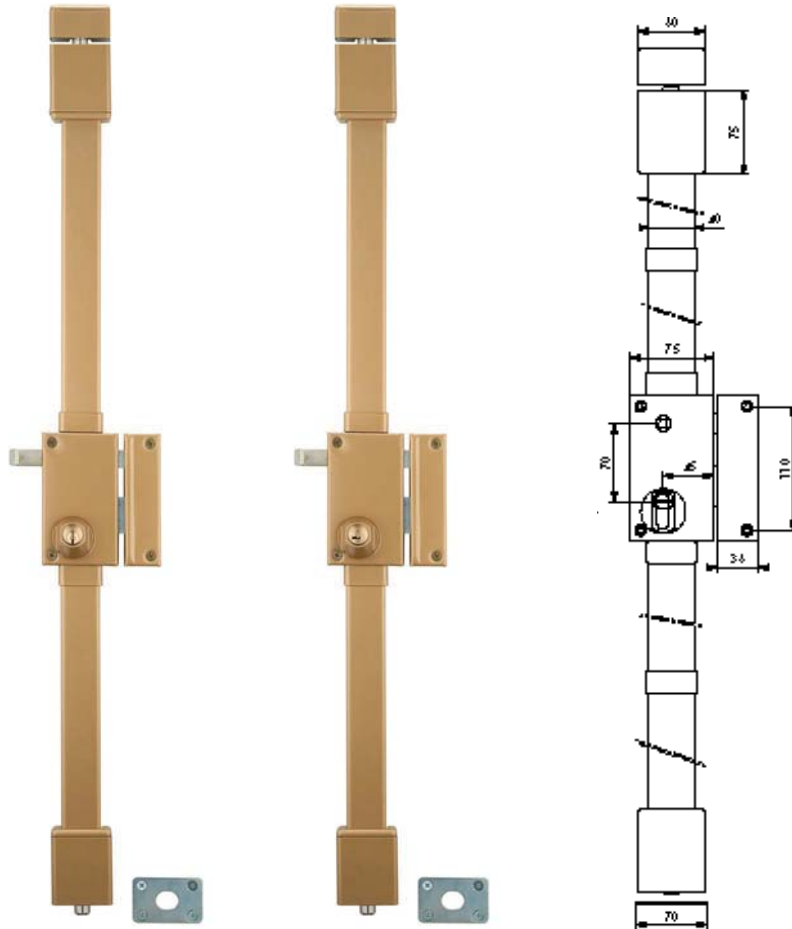

Description/Description/Descripción

Boîtier en acier cambré ép. 2 /10ème. Coffre cambré 75 x 130 mm axe à 45 mm. Jeu de tringles pour une hauteur maximum de porte de 2 2 m. Mécanisme intérieur type équerre permettant la manœuvre du 1/2 tour de l'intérieur comme de l'extérieur avec la clé. Pêne et 1/2 tour en laiton massif. Pênes haut et bas en acier zingué. Gâche avec têtère de haute résistance. Enjoliveur de cylindre côté intérieur. Carré 7 mm. Poignée double anodisé couleur F 2 fournie pour serrure à fouillot. Le montage de la serrure ne nécessite pas d'entaillage spécifique de la porte. Options : Kit de tringles pour une hauteur maximum de porte de 3 m. Points de verrouillage complémentaires. Ensemble porte palière. Poignée simple. Protège-gonds. Cylindre rond Ø 2 mm 6 goupilles permettant 2 5 000 combinaisons. Pour épaisseur de porte de 45 mm maxi. Protection contre le perçage par première goupille en acier trempé. 4 clés acier nickelé. Possibilité de commandes en s'entrouvrant et organigrammes. Cylindre rond Transit 2 double cylindre laiton Ø 2 mm, longueur 45 mm. Mécanisme à 8 goupilles protégé contre le crochetage. Protection contre le perçage par 1ère goupille + poussoir en acier trempé. 4 clés plates réversibles en laiton nickelé avec carte de propriété.

Cambered steel case (thickness 20/10 th) 75 x 130 mm. Axis 45 mm. Rods kit for a door of maximum 2,25 m high. Internal square mechanism allowing the use of latch bolt with the key from inside as well as from outside. Brass dead bolt and latch bolt. Hardened up and down steel zinc bolts. High resistant striker. Hub cap for inside part of cylinder. Square 7 mm. Lock assembling without particular cutting the door. Supplied with double handle anodized. Accessories : Rods kit for a maximum 3 m high door. Bolting points. Outside finger plate handle. Simple anodized handle. Hinge protection. Round cylinder Ø 23 mm 6 pins providing up. 265 000 combinations. Maximum door thickness from 40 to 45 mm. Protected with antidrilling pins. Supplied with 4 nickel plated keys. Keyed alike or master key system available. Round cylinder Transit 2 Brass cylinder Ø 23 mm, long. 45 mm. 8 pin mechanism protected against picking. Protection against drilling by hardened steel pins. 4 reversible brass nickel plated keys with a personal security card for key copie
Caja de acero curvado, esp. 20/10. Caja curvada de 75 x 130 mm, eje a 45 mm. Juego de trancas para una altura máxima de puerta de 2,25 m. Mecanismo interior tipo escuadra que permite maniobrar la media vuelta con la llave, tanto desde el interior como desde el exterior. Pestillo y media vuelta de latón macizo. Pestillos alto

y bajo de acero cincado. Cerradero de alta resistencia. Embellecedor de cilindro por el lado interior. Cuadrado 7 mm. Tirador doble anodizado champán suministrado para la cerradura de nuez. El montaje de la cerradura no precisa una entalladura específica de la puerta. Accesorios: Kit de trancas para una altura máxima de la puerta de 3 m. Puntos de cierre complementarios. Conjunto de puerta descansillo. Tirador simple. Protector de goznes. Cilindro redondo - Ø 23 mm 6 pasadores que permiten 265.000 combinaciones. Para puertas con un espesor máximo de 45 mm. Protección contra el taladrado mediante un primer pasador de acero templado. 4 llaves de acero niquelado. Con posibilidad de comandos al. entreabrirse y organigramas. Cilindro redondo Transit 2 Cilindro de latón Ø 23 mm, long. 45 mm. Mecanismo de 8 pistones contra la recogida. Protección contra el taladrado por medio de un pasador de acero templado. 4 llaves planas reversibles de latón niquelado con título de propiedad que permite su reproducción en fábrica.

Finition/Finish/Acabado

Epoxy bronze

Bronze epoxy



Epoxi bronce

Versión/Option/Versión

Droite ou gauche. A TIRAGE ou à fouillot.

Right or left hand. Drawback pull or follwer type.

Derecha o izquierda. De tirador o de nuez.

Designation	Boite	Colis.	Prix	Sachet	Colis.	Prix	Brochable					Colis.	Prix
							France	Euro 1	Euro 2	Euro 3	Euro 4		
SERR. bronze CR Ø 23 6 goup. à tirage 75 x 130 mm droite 4 clés	-	-	-	-	-	-	00750010	-	-	-	-	1	-
SERR. bronze CR Ø 23 6 goup. à tirage 75 x 130 mm gauche 4 clés	-	-	-	-	-	-	00750020	-	-	-	-	1	-
SERR. bronze CR Ø 23 6 goup. à fouillot 75 x 130 mm droite 4 clés	-	-	-	-	-	-	00750110	-	-	-	-	1	-
SERR. bronze CR Ø 23 6 goup. à fouillot 75 x 130 mm gauche 4 clés	-	-	-	-	-	-	00750120	-	-	-	-	1	-
SERR. bronze CR TRANSIT 2 à tirage 75 x 130 mm droite 4 clés	00060010 	1	-	-	-	-	-	-	-	-	-	-	-
SERR. bronze CR TRANSIT 2 à tirage 75 x 130 mm gauche 4 clés	00060020	1	-	-	-	-	-	-	-	-	-	-	-
SERR. bronze CR TRANSIT 2 à fouillot 75 x 130 mm droite 4 clés	00060110	1	-	-	-	-	00760110	-	-	-	-	1	-
SERR. bronze CR TRANSIT 2 à fouillot 75 x 130 mm gauche 4 clés	00060120	1	-	-	-	-	00760120	-	-	-	-	1	-
KIT TRINGLE plate bronze pour serrure haut. porte 3 m, epoxy or	00032316 	1	-	-	-	-	-	-	-	-	-	-	-
BEQUILLE DOUBLE anodisé 1 portée 7 long. 100 mm	00004479	1	-	-	-	-	-	-	-	-	-	-	-
BEQUILLE SIMPLE anodisé sans portée 7 avec arrêt long. 50 mm	00014479	1	-	-	-	-	-	-	-	-	-	-	-
POIGNEE porte palière TARGA CR Ø 23 epoxy bronze droite	00001372	1	-	-	-	-	00201372	-	-	-	-	10	-
POIGNEE porte palière TARGA CR Ø 23 epoxy bronze gauche	00001382	1	-	-	-	-	00201382	-	-	-	-	10	-
PROTEGE GONDS la paire	00025000	10	-	-	-	-	00225000	-	-	-	-	10	-

 Non stocké/Non-stored/Producto no estocado -  Sur stock Europe Zone 1 et Zone 2, nous consulter pour délai d'approvisionnement -  Epuisement/Stock depletion/Agotamiento del stock



Serrure 3 points / BELUGA CR PROTECT



GARANTIE



X 4

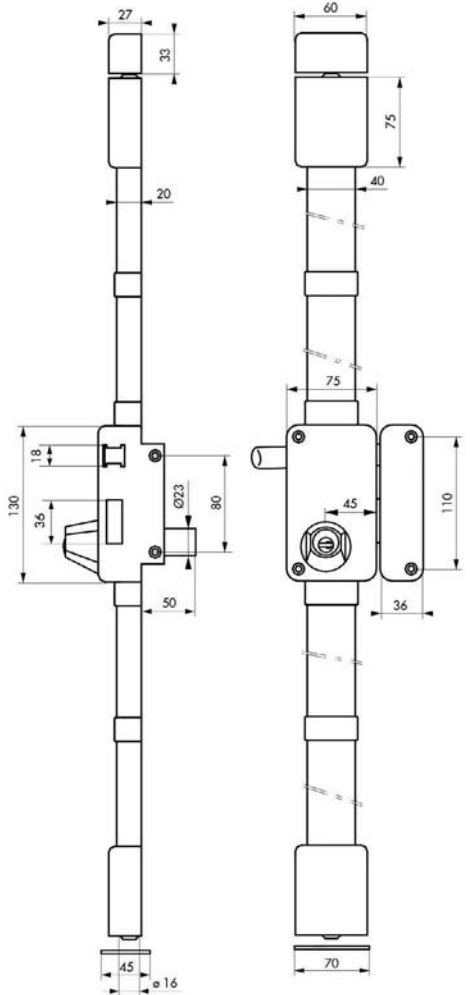

**Description/Description/Descripción**

Boîtier en acier embouti ép. 2 /10ème. Coffre de 75 x 130 mm, axe à 45 mm. Tringles standard permettant une condamnation de porte de 1,65 m à 2,25 m. Mécanisme intérieur type équerre permettant la manœuvre du 1/2 tour avec la clé, de l'intérieur comme de l'extérieur. Pêne dormant et 1/2 tour en laiton massif. Pênes haut et bas en acier Ø 16 mm sur tringles plates en acier permettant un ajustement très précis à la longueur désirée et ne nécessitant aucune recoupe. Gâche équerre de haute résistance. Cache-tringles, guides et gâches de pênes haut et bas en acier ne laissant apparaître aucune vis de fixation. Carré 7 mm - Poignée double fournie pour serrure à fouillot. Le montage de la serrure ne nécessite pas d'entaillage spécifique de la porte. Cylindre rond HG5 Double cylindre laiton Ø 23 mm, longueur 60 mm. Mécanisme à 5 goupilles. 4 clés en acier nickelé. Cylindre rond TRANSIT 2 double cylindre laiton Ø 23 mm, longueur 60 mm. Mécanisme à 8 goupilles protégé contre le crochetage. Protection contre le perçage par 1ère goupille + poussoir en acier trempé. 4 clés plates réversibles en laiton nickelé avec carte de propriété. Options : Jeu de tringles grande hauteur permettant un verrouillage jusqu'à 3,00 m. Poignée de tirage extérieure - Poignée simple laqué blanc ou marron - Protège-gonds. Kit gâche pour huisserie métallique, pour porte à recouvrement.

Stamped steel case (thickness 20/10 th) 75 x 130 mm. Axis 45 mm. Standard rods for bolting door from 1,65 m to 2,25 m. Internal square mechanism. allowing the use of 1/2 turn with the key from inside as well as from outside. Steel up and down bolts Ø 16 mm with steel rods which can be adjusted at the good height without cutting rods. High resistant square striker. Rods guides and strikers up and down steel protections. Hub cap of inside cylinder. Square 7 mm. Lock assembling without cutting the door. Supplied with double handle. Accessories :Rods kit for a maximum 3 m high door. Finger plate outside handle. Single handle white or brown lacquered. Hinge protection. Striker kit for metal door frame. Striker kit for overlapping door. Round cylinder HG5 Brass cylinder Ø 23 mm, long. 60 mm 5 pin mechanism 4 nickel plated keys Round cylinder TRANSIT 2 Brass cylinder Ø 23 mm, long. 60 mm. 8 pin mechanism protected against picking. Protection against drilling by hardened steel pins. 4 reversible brass nickel plated keys with a personal security card for key copie.

Caja de acero embutido de 20/10 de espesor. Caja de 75 x 130 mm, eje a 45 mm. Trancas estándar que permiten la condenación de una puerta de 1,65 a 2,25 m. Mecanismo interior de tipo escuadra que permite maniobrar la media vuelta con la llave, tanto desde el interior como desde el exterior. Pestillo durmiente y media vuelta de latón macizo. Pestillos alto y bajo de acero, Ø 16 mm, en trancas de acero que permiten un ajuste muy preciso a la longitud deseada y no precisan ningún corte. Cerradero de escuadra de alta resistencia. Cubretrancas, guías y cerraderos de pestillos alto y bajo de acero que ocultan los tornillos de fijación. Embellecedor de cilindro por el lado interior. Cuadrado 7 mm. Tirador doble que suministrado para la cerradura de nuez. El montaje de la cerradura no precisa una entalladura específica de la puerta. Accesorios: Juego de trancas de gran altura que permiten un cierre de hasta 3 m. Tirador exterior. Tirador simple lacado blanco o marrón. Protector de goznes. Kit de cerradero para marco metálico. Kit de cerradero para puerta que recubre el marco. Cilindro redondo HG5 Cilindro de latón Ø 23 mm, long. 60 mm. Mecanismo de 5 pistones. 4 llaves de acero niquelado. Cilindro redondo TRANSIT 2 Cilindro de latón Ø 23 mm, long. 60 mm. Mecanismo de 8 pistones contra la recogiendo. Protección contra el taladrado por medio de un pasador de acero templado. 4 llaves planas reversibles de latón niquelado con título de propiedad que permite su reproducción en fábrica.

Finition/Finish/Acabado

Epoxy marron ou blanc

Brown or white epoxy

Epoxi marrón o blanco

Versión/Option/Versión

Droite ou gauche. A TIRAGE ou à fouillot. Avec ou sans cylindre.

Right or left hand. Drawback pull or follower type. With or without cylinder.

Derecha o izquierda. De tirador o de nuez. Con o sin cilindro.



Serrure 3 points / BELUGA CR

PROTECT



GARANTIE

Designation	Boite	Colis.	Prix	Sachet	Colis.	Prix	Brochable					Colis.	Prix
							France	Euro 1	Euro 2	Euro 3	Euro 4		
SERR. BELUGA marron CR HG5 à tirage 75 x 130 drte 4 clés	00079410	1	-	-	-	-	-	-	-	-	-	-	-
SERR. BELUGA marron CR HG5 à tirage 75 x 130 gche 4 clés	00079420	1	-	-	-	-	-	-	-	-	-	-	-
SERR. BELUGA blanche CR HG5 à tirage 75 x 130 drte 4 clés	00079411	1	-	-	-	-	-	-	-	-	-	-	-
SERR. BELUGA blanche CR HG5 à tirage 75 x 130 gche 4 clés	00079421	1	-	-	-	-	-	-	-	-	-	-	-
SERR. BELUGA marron CR HG5 à fouillot 75 x 130 drte 4 clés	00079510	1	-	-	-	-	-	-	-	-	-	-	-
SERR. BELUGA marron CR HG5 à fouillot 75 x 130 gche 4 clés	00079520	1	-	-	-	-	-	-	-	-	-	-	-
SERR. BELUGA blanche CR HG5 à fouillot 75 x 130 drte 4 clés	00079511	1	-	-	-	-	-	-	-	-	-	-	-
SERR. BELUGA blanche CR HG5 à fouillot 75 x 130 gche 4 clés	00079521	1	-	-	-	-	-	-	-	-	-	-	-
SERR. BELUGA marron CR TRANSIT 2 à tirage 75 x 130 drte 4 clés	00069410	1	-	-	-	-	-	-	-	-	-	-	-
SERR. BELUGA marron CR TRANSIT 2 à tirage 75 x 130 gche 4 clés	00069420	1	-	-	-	-	-	-	-	-	-	-	-
SERR. BELUGA blanche CR TRANSIT 2 à tirage 75 x 130 drte 4 clés	00069411	1	-	-	-	-	-	-	-	-	-	-	-
SERR. BELUGA blanche CR TRANSIT 2 à tirage 75 x 130 gche 4 clés	00069421	1	-	-	-	-	-	-	-	-	-	-	-
SERR. BELUGA marron CR TRANSIT 2 à fouillot 75 x 130 drte 4 clés	00069510 NS	1	-	-	-	-	-	-	-	-	-	-	-
SERR. BELUGA marron CR TRANSIT 2 à fouillot 75 x 130 gche 4 clés	00069520 NS	1	-	-	-	-	-	-	-	-	-	-	-
SERR. BELUGA blanche CR TRANSIT 2 à fouillot 75 x 130 drte 4 clés	00069511 NS	1	-	-	-	-	00769511 NS	-	-	-	-	1	-

NS Non stocké/Non-stored/Producto no estocado - ☑ Sur stock Europe Zone 1 et Zone 2, nous consulter pour délai d'approvisionnement - ☒ Epuisement/Stock depletion/Agotamiento del stock



Designation	Boite	Colis.	Prix	Sachet	Colis.	Prix	Brochable					Colis.	Prix
							France	Euro 1	Euro 2	Euro 3	Euro 4		
SERR. BELUGA blanche CR TRANSIT 2 à fouillot 75 x 130 gche 4 clés	00069521	1	-	-	-	-	00769521 NS	-	-	-	-	1	-
KIT TRINGLE PLATE blanc pour hauteur porte 3,00 m	00032321	1	-	-	-	-	-	-	-	-	-	-	-
KIT TRINGLE PLATE marron pour hauteur porte 3,00 m	00032320	1	-	-	-	-	-	-	-	-	-	-	-
BEQUILLE double marron - 1 portée	00000490	1	-	-	-	-	-	-	-	-	-	-	-
BEQUILLE double blanc - 1 portée	00000491	1	-	-	-	-	-	-	-	-	-	-	-
BEQUILLE simple marron sans portée carré 7 long. 50mm avec arrêt	00012490	1	-	-	-	-	-	-	-	-	-	-	-
BEQUILLE simple blanc sans portée carré 7 long. 50mm avec arrêt	00012491	1	-	-	-	-	-	-	-	-	-	-	-
1/2 BEQUILLE marron - 1 portée carré 7100mm	-	-	-	-	-	-	00200494	-	-	-	-	10	-
KIT D'ADAPTATION pour huisserie métallique droite blanc	-	-	-	-	-	-	00230322	-	-	-	-	1	-
KIT D'ADAPTATION pour huisserie métallique gauche blanc	-	-	-	-	-	-	00230323	-	-	-	-	1	-
KIT D'ADAPTATION pour huisserie métallique droite marron	-	-	-	-	-	-	00230324	-	-	-	-	1	-
KIT D'ADAPTATION pour huisserie métallique gauche marron	-	-	-	-	-	-	00230325	-	-	-	-	1	-
KIT D'ADAPTATION pour porte à recouvrement droite blanc	-	-	-	-	-	-	00230328	-	-	-	-	1	-
KIT D'ADAPTATION pour porte à recouvrement gauche blanc	-	-	-	-	-	-	00230329	-	-	-	-	1	-
KIT D'ADAPTATION pour porte à recouvrement droite marron	-	-	-	-	-	-	00230326	-	-	-	-	1	-
KIT D'ADAPTATION pour porte à recouvrement gauche marron	-	-	-	-	-	-	00230327	-	-	-	-	1	-
PROTEGE GONDS la paire	00025000	10	-	-	-	-	00225000	-	-	-	-	10	-

NS Non stocké/Non-stored/Producto no estocado - Sur stock Europe Zone 1 et Zone 2, nous consulter pour délai d'approvisionnement - E Epuement/Stock depletion/Agotamiento del stock



Serrure 3 points / HORGА CP

PROTECT



GARANTIE



Description/Description/Descripción

Boîtier en acier embouti ép. 2 /10ème. Coffre de 140 x 88 mm. Tringles standard permettant une condamnation de porte de 1,65 m à 2 2 m. Mécanisme intérieur type équerre permettant la manœuvre du 1/2 tour avec la clé, de l'intérieur comme de l'extérieur. Pêne dormant et 1/2 tour en laiton massif. Pêne haut et bas en acier Ø 16 mm sur tringles plates en acier permettant un ajustement très précis à la longueur désirée et ne nécessitant aucune recoupe. Gâche avec têtère de haute résistance. Cache-tringles, guides et gâches de pènes haut et bas en acier ne laissant apparaître aucune vis de fixation. Enjoliveur de cylindre côté intérieur. Carré 6 mm. Le montage des serrures ne nécessite pas d'entaillage spécifique de la porte. Options : Jeu de tringles grande hauteur permettant un verrouillage jusqu'à 3 m. Bouton double. Cylindre profilé TRANSIT 2 cylindres à profil européen normalisé en laiton poli 30 x 65 mm pour porte de 45 mm. Mécanisme à 8 goupilles protégé contre le crochetage permettant 410 000 combinaisons. Protection contre l'effraction de la partie saillante du cylindre (anti-snap). Panneton en acier fritté anti-arrachement. 4 clés plates réversibles en laiton nickelé avec carte de propriété. Possibilité de s'entrouvrant et organigramme.

Stamped steel case (20/10 th). 140 x 88 mm. Standard rods for bolting a door from 1,65 m to 2,25 m. Internal square mechanism allowing the use of 1/2 turn. with the key from inside as well as from outside. Brass dead bolt and latch bolt. Steel up and down bolts. Ø 16 mm with steel rods which can be adjusted at the good height without cutting rods. High resistant square striker. Hardened rods protection, guide and strikers for up and down bolts in steel. Hub cap of inside cylinder. Square 6 mm. Lock assembling without cutting the door. Accessories : Rods kit for a maximum 3 m high door. Finger plate outside handle. Double knob. Hinge protection. Profile cylinder TRANSIT 2 Brass european profile cylinder. 30 x 65 mm for 45 mm door thickness. 8 pin mechanism against picking providing up to 410 000 combinations. Protection against the destruction of the projecting portion of the cylinder (anti-snap). Driver cam made of powered metal.

Supplied with 4 reversible nickel plated brass keys with property title allowing exclusive reproduction of keys in the factory. Keyed alike and master key system available. Caja de acero embutido de 20/10 de espesor. Caja de 140 x 88 mm. Trancas estándar que permiten la condenación de una puerta de 1,65 a 2,25 m. Mecanismo interior de tipo. escuadra que permite maniobrar la media vuelta con la llave, tanto desde el interior como desde el exterior. Pestillo durmiente y media vuelta de latón macizo. Pestillo alto y bajo de acero. Ø 16 mm, en trancas de acero que permiten un ajuste muy preciso con la longitud. deseada y no necesitan ningún corte. Cerradero de escuadra de alta resistencia. Cubretrancas, guías y cerraderos de pestillos alto y bajo de acero que ocultan los tornillos de fijación. Embellecedor de cilindro por el lado interior. Cuadrado 6 mm. El montaje de las cerraduras no precisa una entalladura específica de la puerta. Accesorios: Juego de trancas de gran altura que permiten un cierre de hasta 3 m. Botón doble. Protector de goznes. Cilindro Cilindro perfilado TRANSIT 2 Cilindro de perfil europeo normalizado de latón de 30 x 65 mm para puerta de 45 mm. Mecanismo de 8 pasadores anti-forzamiento, que permite 410.000 combinaciones. Protección contra la manipulación de la parte saliente de cilindro. Pivote de acero sinterizado antiarrancamiento. 4 llaves planas reversibles de latón niquelado con título de propiedad que permite la reproducción de las llaves. exclusivamente en fábrica. Posibilidad de entreabrirse y organigrama.

Finition/Finish/Acabado

Epoxy marron ou blanc

Brown or white epoxy

Epoxi marrón o blanco

Version/Option/Versión

Droite ou gauche. A TIRAGE ou à fouillot. Avec ou sans cylindre.

Right or left hand. Drawback pull or follower type. With or without cylinder.

Derecha o izquierda. De tirador o de nuez. Con o sin cilindro.

Serrure 3 points / HORGА CP

PROTECT

Designation	Boite	Colis.	Prix	Sachet	Colis.	Prix	Brochable					Colis.	Prix
							France	Euro 1	Euro 2	Euro 3	Euro 4		
BOITIER DE SERRURE HORGА marron à tirage 140 x 88 mm droite	00047315	1	-	-	-	-	-	-	-	-	-	-	-
BOITIER DE SERRURE HORGА marron à tirage 140 x 88 mm gauche	00047325	1	-	-	-	-	-	-	-	-	-	-	-
BOITIER DE SERRURE HORGА blanc à tirage 140 x 88 mm droite	00048315	1	-	-	-	-	-	-	-	-	-	-	-
BOITIER DE SERRURE HORGА blanc à tirage 140 x 88 mm gauche	00048325	1	-	-	-	-	-	-	-	-	-	-	-
BOITIER DE SERRURE HORGА marron à fouillot 140 x 88 mm droite	00047316	1	-	-	-	-	-	-	-	-	-	-	-
BOITIER DE SERRURE HORGА marron à fouillot 140 x 88 mm gauche	00047326	1	-	-	-	-	-	-	-	-	-	-	-
BOITIER DE SERRURE HORGА blanc à fouillot 140 x 88 mm droite	00048316	1	-	-	-	-	-	-	-	-	-	-	-
BOITIER DE SERRURE HORGА blanc à fouillot 140 x 88 mm gauche	00048326	1	-	-	-	-	-	-	-	-	-	-	-
SERR. HORGА marron CP TRANSIT 2 à tirage 140 x 88 mm drte 4 clés	-	-	-	-	-	-	00757315	-	-	-	-	1	-
SERR. HORGА marron CP TRANSIT 2 à tirage 140 x 88 mm gche 4 clés	-	-	-	-	-	-	00757325	-	-	-	-	1	-
SERR. HORGА blanche CP TRANSIT 2 à tirage 140 x 88 mm drte 4 clés	-	-	-	-	-	-	00758315 NS	-	-	-	-	1	-
SERR. HORGА blanche CP TRANSIT 2 à tirage 140 x 88 mm gche 4 clés	-	-	-	-	-	-	00758325 NS	-	-	-	-	1	-
SERR. HORGА marron CP TRANSIT 2 à fouillot 140 x 88 mm drte 4 clés	-	-	-	-	-	-	00757316 NS	-	-	-	-	1	-
SERR. HORGА marron CP TRANSIT 2 à fouillot 140 x 88 mm gche 4 clés	-	-	-	-	-	-	00757326 NS	-	-	-	-	1	-
SERR. HORGА blanche CP TRANSIT 2 à fouillot 140 x 88 mm drte 4 clés	-	-	-	-	-	-	00758316 NS	-	-	-	-	1	-
SERR. HORGА blanche CP TRANSIT 2 à fouillot 140 x 88 mm gche 4 clés	-	-	-	-	-	-	00758326 NS	-	-	-	-	1	-
BOUTON DOUBLE rond laqué marron 1 portée carré 6 longueur 100 mm	00000492	1	-	-	-	-	-	-	-	-	-	-	-
BOUTON DOUBLE rond laqué blanc 1 portée carré 6 longueur 100 mm	00000493	1	-	-	-	-	-	-	-	-	-	-	-
KIT TRINGLE PLATE marron pour hauteur porte 3,00 m	00032320	1	-	-	-	-	-	-	-	-	-	-	-
KIT TRINGLE PLATE blanc pour hauteur porte 3,00 m	00032321	1	-	-	-	-	-	-	-	-	-	-	-
PROTEGE GONDS la paire	00025000	10	-	-	-	-	00225000	-	-	-	-	10	-

NS Non stocké/Non-stored/Productos no estocado - Sur stock Europe Zone 1 et Zone 2, nous consulter pour délai d'approvisionnement - E Epuement/Stock depletion/Agotamiento del stock



Serrure 3 points / CARENE

ECO



GARANTIE



X 4

Description/Description/Descripción

Boîtier en acier cambré ép. 2 /10ème. Coffre de 75 x 130 mm, axe à 45 mm. Tringles standard permettant une condamnation de porte de 1,65 m à 2 2 m. Mécanisme intérieur type équerre permettant la manœuvre du 1/2 tour avec la clé, de l'intérieur comme de l'extérieur. Pêne dormant et demi-tour en acier zingué. Pêne haut et bas en acier permettant un ajustement à la longueur désirée. Gâche avec têtère de haute résistance. Cache-tringles, guides et gâches de pènes haut et bas en acier. Enjoliveur de cylindre côté intérieur. Carré 7 mm. Poignée double fournie pour serrure à fouillot. Le montage des serrures ne nécessite pas. d'entaillage spécifique de la porte. Options : Jeu de tringles grande hauteur permettant un verrouillage jusqu'à 3,00 m. Poignée de tirage extérieure. Poignée simple aluminium anodisé. Protège-gonds. Cylindre profilé SHG6 Cylindre à profil européen normalisé en laiton nickelé 30 x 65 mm pour porte de 45 mm. Mécanisme 6 goupilles permettant 16 000 combinaisons. Panneton en acier fritté anti-arrachement. Protection contre le perçage par aiguille en acier trempé. 4 clés plates réversibles en laiton nickelé avec carte personnelle. Possibilité de s'entrouvrant et onigramme.

Cambered steel case of 20/10 thickness 75 x 130 mm. Axis 45 mm. Internal square mechanism allowing the use of 1/2 turn with the key from inside as well as from outside zinc plated steel dead bolt and latch bolt. Up and down round bolts with telescopic steel rods which can be adjusted at the good height without cutting rods. High resistant striker. Rod protection, guide and strikers for up and down bolts in steel. Standard rods for bolting a door from 1,65 m to 2,25 m. Hub cap of inside cylinder. Square 7 mm. Supplied with double handle. Lacquered brown or white locks available. Lock assembling without cutting the doorAccessories :Rods kit for a maximum 3 m high door. Finger plate outside handle. Single or double anodized handle. Hinge protection. Profile cylinders SHG6 Standardized European nickel-plated brass profile cylinder 30 x 65 mm for 45-mm door. 6-pin mechanism providing 16,000 combinations. Sintered steel bit against pull out. Protection against drilling through hardened steel needle

Serrure 3 points / CARENE

ECO



Caja de acero curvado de 20/10 de espesor. Caja de 75 x 130 mm, eje a 45 mm. Trancas estándar que permiten la condenación de una puerta de 1,65 a 2,25 m. Mecanismo interior de tipo escuadra que permite maniobrar la media vuelta con la llave, tanto desde el interior como desde el exterior. Pestillo durmiente y media vuelta de acero cincado. Pestillo alto y bajo redondo en trancas telescópicas de acero que permiten un ajuste muy preciso con la longitud deseada y que no precisan ningún corte. Cerradero de alta resistencia. Cubretrancas, guías y cerraderos de pestillos alto y bajo de acero que ocultan los tornillos de fijación, embellecedor de cilindro por el lado interior. Cuadrado 7 mm. Tirador doble suministrado para la cerradura de nuez. El montaje de las cerraduras no precisa una entalladura específica de la puerta. Accesorios: Juego de trancas de gran altura que permiten un cierre de hasta 3 m. Tirador exterior. Tirador simple de aluminio anodizado. Protector de goznes. Cilindro perfilado SHG6 Cilindro de perfil europeo normalizado de latón niquelado. 30 x 65 mm para puerta de 45 mm. Mecanismo de 6 pasadores que permiten 16 000 combinaciones. Paletón de acero sinterizado anti-desgarramientos. Protección contra la perforación por aguja de acero templado. 4 llaves planas reversible de latón niquelado con tarjeta personal. Posibilidad de entreabrirse y organigrama.

Finition/Finish/Acabado

Epoxy bronze

Bronze epoxy

Epoxi bronce

Version/Option/Versión

Droite ou gauche. A TIRAGE ou à fouillot. Avec ou sans cylindre.

Right or left hand. Drawback pull or follower type. With or without cylinder.

Derecha o izquierda. De tirador o de nuez. Con o sin cilindro.

Designation	Boîte	Colis.	Prix	Sachet	Colis.	Prix	Brochable					Colis.	Prix
							France	Euro 1	Euro 2	Euro 3	Euro 4		
SERR. CARENE bronze CP SHG 6 à fouillot 75 x 130 mm drte 4 clés	-	-	-	-	-	-	00750740	-	-	-	-	1	-
SERR. CARENE bronze CP SHG 6 à fouillot 75 x 130 mm gche 4 clés	-	-	-	-	-	-	00750741	-	-	-	-	1	-
KIT TRINGLE bronze pour CARENE haut. porte 3 m	00030317 NS	1	-	-	-	-	-	-	-	-	-	-	-
POIGNEE porte palière TARGA bronze droite	00003372	1	-	-	-	-	00203372	-	-	-	-	10	-
POIGNEE porte palière TARGA bronze gauche	00003382	1	-	-	-	-	00203382	-	-	-	-	10	-
BEQUILLE DOUBLE anodisé F2 1 portée 7 long. 100 mm	00004479	1	-	-	-	-	-	-	-	-	-	-	-
BEQUILLE SIMPLE anodisé F2 sans portée 7 avec arrêt long. 50 mm	00014479	1	-	-	-	-	-	-	-	-	-	-	-
PROTEGE GONDS la paire	00025000	10	-	-	-	-	00225000	-	-	-	-	10	-

NS Non stocké/Non-stored/Producto no estocado - Sur stock Europe Zone 1 et Zone 2, nous consulter pour délai d'approvisionnement - E Epuisement/Stock depletion/Agotamiento del stock



Serrure 3 points / TARGA CP

ECO



GARANTIE

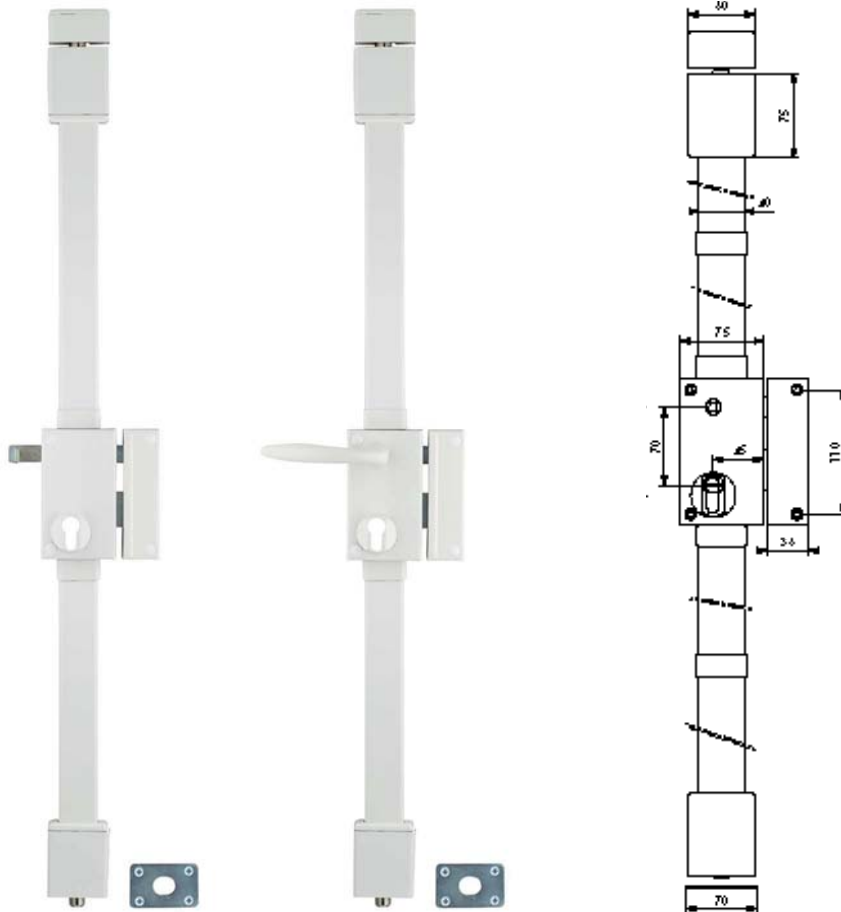

Description/Description/Descripción

Boîtier en acier cambré ép. 2 /10ème. Coffre cambré 75 x 130 mm axe à 45 mm. Jeu de tringles pour une hauteur maximum de porte de 2,25 m. Mécanisme intérieur type équerre permettant la manœuvre du 1/2 tour de l'intérieur comme de l'extérieur avec la clé. Pêne et 1/2 tour en acier zingué. Pênes haut et bas en acier zingué. Gâche avec têtère de haute résistance. Enjoliveur de cylindre côté intérieur. Carré 7 mm - Poignée double anodisé couleur F 2 ou laqué blanc selon modèle fournie pour serrure à fouillot. Le montage de la serrure ne nécessite pas d'entaillage spécifique de la porte. Options : Kit de tringles pour une hauteur maximum de porte de 3 m. Points de verrouillage complémentaires. Cylindre profilé SACylindre à profil européen normalisé en laiton. 30 x 65 mm pour porte de 45 mm maxi. Mécanisme à 5 goupilles. Panneton en acier fritté anti-arrachement. 4 clés laiton nickelé.

Cambered steel case (thickness 20/10 th) 75 x 130 mm. Axis 45 mm. Rods kit for a door of maximum 2,25 m high. Internal square mechanism allowing the use of latch bolt with the key from inside as well as from outside. Zinc plated steel dead bolt and latch bolt. Hardened up and

down steel zinc bolts. High resistant striker. Hub cap for inside part of cylinder. Square 7 mm. Lock assembling without particular cutting the door. Supplied with double handle anodized or white lackered. Accessories: Rods kit for a maximum 3 m high door. Bolting points. Outside finger plate handle. Simple anodized handle. Hinge protection. Profile cylinders SA Brass european profile cylinder. 30 x 65 mm for 45 mm thickness door. 5 pin mechanism. Driver came made of powered metal. Supplied with 4 nickel plated keys.

Caja de acero curvado de 20/10 de espesor. Caja curvada de 75 x 130 mm, eje a 45mm. Juego de trancas para una altura máxima de puerta de 2,25 m. Mecanismo interior de tipo escuadra que permite maniobrar la media vuelta con la llave, tanto desde el interior como desde el exterior. Pestillo y media vuelta de acero cincado. Pestillos alto y bajo de acero cincado. Cerradero de alta resistencia. Embellecedor de cilindro por el lado interior. Cuadrado 7 mm. Tirador doble anodizado champán o epoxy blanco suministrado para la cerradura de nuez. El montaje de la cerradura no. precisa una entalladura específica de la puerta. Accesorios: Kit de trancas para una altura máxima de la puerta de 3 m. Puntos de cierre

Serrure 3 points / TARGA CP

ECO



GARANTIE

complementarios. Conjunto de puerta descansillo.
Tirador simple. Protector de goznes. Cilindro perfilado 30 x 65 mm, para una puerta de 45 mm como máximo.
Mecanismo de 5 pasadores. Pivote de acero sinterizado antiarrancamiento. 4 llaves de acero niquelado.

Finition/Finish/Acabado

Epoxi bronze ou blanc

Brown or bronze epoxy

Epoxi marrón o bronze

Version/Option/Versión

Droite ou gauche. A TIRAGE ou à fouillot.

Avec ou sans cylindre.

Right or left hand. Drawback pull or follower type. With or without cylinder.

Derecha o izquierda. De tirador o de nuez.

Con o sin cilindro.

Designation	Boite	Colis.	Prix	Brochable				Colis.	Prix
				France	Euro 1	Euro 2	Euro 3		
BOITIER DE SERR. TARGA CP blanche à tirage 75 x 130 mm droite	00051612	1	-	-	-	-	-	-	-
BOITIER DE SERR. TARGA CP blanche à tirage 75 x 130 mm gauche	00051622	1	-	-	-	-	-	-	-
BOITIER DE SERR. TARGA CP bronze à tirage 75 x 130 mm droite	00051610	1	-	-	-	-	-	-	-
BOITIER DE SERR. TARGA CP bronze à tirage 75 x 130 mm gauche	00051620	1	-	-	-	-	-	-	-
BOITIER DE SERR. TARGA CP blanche à fouillot 75 x 130 mm droite	00051712	1	-	-	-	-	-	-	-
BOITIER DE SERR. TARGA CP blanche à fouillot 75 x 130 mm gauche	00051722	1	-	-	-	-	-	-	-
BOITIER DE SERR. TARGA CP bronze à fouillot 75 x 130 mm droite	00051710	1	-	00752318	-	-	-	-	-
BOITIER DE SERR. TARGA CP bronze à fouillot 75 x 130 mm gauche	00051720	1	-	00752329	-	-	-	-	-
SERRURE TARGA blanche CP à tirage 75 x 130 mm droite 4 clés	-	-	-	00750612 NS	-	-	-	1	-
SERRURE TARGA blanche CP à tirage 75 x 130 mm gauche 4 clés	-	-	-	00750622 NS	-	-	-	1	-
SERRURE TARGA bronze CP à tirage 75 x 130 mm droite 4 clés	-	-	-	00750610 NS	-	-	-	1	-
SERRURE TARGA bronze CP à tirage 75 x 130 mm gauche 4 clés	-	-	-	00750620 NS	-	-	-	1	-
SERRURE TARGA blanche CP à fouillot 75 x 130 mm droite 4 clés	-	-	-	00750712	-	-	-	1	-
SERRURE TARGA blanche CP à fouillot 75 x 130 mm gauche 4 clés	-	-	-	00750722	-	-	-	1	-
SERRURE TARGA bronze CP à fouillot 75 x 130 mm droite 4 clés	-	-	-	00750710	-	-	-	1	-
KIT TRINGLE pour TARGA haut. porte 3 m, epoxy blanc	00032321 E NS	1	-	-	-	-	-	-	-
KIT TRINGLE pour serrure haut. porte 3 m, epoxy or	00032316 E	1	-	-	-	-	-	-	-
BEQUILLE DOUBLE laquée blanc 1 portée 7 longueur 100 mm	00004478	1	-	-	-	-	-	-	-
BEQUILLE DOUBLE anodisé 1 portée 7 long. 100 mm	00004479	1	-	-	-	-	-	-	-
BEQUILLE SIMPLE laquée blanc sans portée ? 7 avec arrêt long. 50 mm	00014478	1	-	-	-	-	-	-	-
BEQUILLE SIMPLE anodisé sans portée 7 avec arrêt long. 50 mm	00014479	1	-	-	-	-	-	-	-
PROTEGE GONDS la paire	00025000	10	-	00225000	-	-	-	10	-
POIGNEE porte palière TARGA bronze droite	00003372	1	-	00203372	-	-	-	10	-
POIGNEE porte palière TARGA bronze gauche	00003382	1	-	00203382	-	-	-	10	-

NS Non stocké/Non-stored/Productos no estocados - E Sur stock Europe Zone 1 et Zone 2, nous consulter pour délai d'approvisionnement - E Epuement/Stock depletion/Agotamiento del stock

Serrure 3 points / MELISSA
PROTECT



GARANTIE



Serrure 3 points / MELISSA

PROTECT



Description/Description/Descripción

Boîtier peint époxy en acier embouti, tête cambrée ép. 2/10ème. Coffre de 85 x 174 mm, axe à 50 mm, entraxe 70 mm. Tringles standard permettant une condamnation de porte de 1,95 m à 2,20 m. Mécanisme permettant la manœuvre 1/2 tour avec la clé, de l'intérieur comme de l'extérieur. 3 pènes dormant Ø 16 mm et 1 pêne 1/2 tour Ø 18 mm en acier nickelé. Pênes haut et bas en acier nickelé Ø 14 mm sur tringles télescopiques en acier permettant un ajustement très précis à la longueur désirée. Gâche basse en acier zingué ép. 3 mm. Carré 7 mm. Béquille double fournie. Installation des tringles et cache-tringles, sans recoupe. Utiliser un cylindre 30 x 65 mm pour une porte d'épaisseur 45 mm.

Steel pressed case, epoxy painted. With cambered forend, thickness 20/10th. Case 85 x 174 mm, axis 50mm, center distance 70mm. Standard rods to lock a door from 1,95 m to 2,20 m. Mechanism allowing the use of the latch bolt with the key, from inside as well as from outside. 3 deadbolts Ø 16 mm and 1 latchbolt Ø 18 mm in nickel plated steel. Up and down nickel plated steel bolts Ø 14 mm on telescopic steel rods allowing an adjustment at the good height. Low striker in zinc plated steel, thickness 3mm. Square 7mm. Supplied with double handle. Installation of rods and rods protections without cutting. To use with a cylinder 30 x 65mm for a door thickness of 45mm.

Caja pintada epoxi de acero embutido, cabeza curvada, 20/10 de espesor. Caja de 85 x 174 mm, eje a 50 mm, entre eje 70 mm. Trancas estándar que permiten condenación / enclavamiento de puerta de 1,95 m a 2,20 m. Mecanismo que permite maniobrar la media vuelta con la llave, tanto desde el interior como desde el exterior. 3 pestillos durmientes Ø 16 mm y 1 pestillo durmiente con media vuelta Ø 18 mm de acero niquelado. Pestillos alto y bajo de acero, Ø 14 mm en trancas de acero que permiten un ajuste muy preciso a la longitud deseada. Cerradero bajo de acero cincado, con espesor de 3 mm. Cuadrado 7 mm. Reversible derecha / izquierda. Instalación de trancas y cubretrancas regulable. Se utiliza un cilindro de 30 x 65 mm para una puerta de espesor 45 mm.

Finition/Finish/Acabado

Epoxy or ou blanc.

Gold or white epoxy.

Epoxi dorado o blanco.

Version/Option/Versión

Droite ou gauche.

Right or left hand.

Derecha o izquierda.

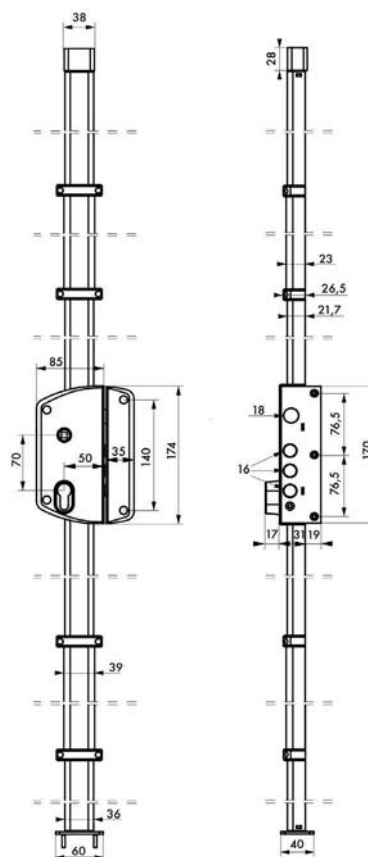

Designation	Boite	Colis.	Prix	Sachet	Colis.	Prix	Brochable					Colis.	Prix
							France	Euro 1	Euro 2	Euro 3	Euro 4		
BOITIER de serrure MELISSA bronze à fouillot 85 x 174 mm droite	00050840	1	-	-	-	-	00750840	-	-	-	-	1	-
BOITIER de serrure MELISSA bronze à fouillot 85 x 174 mm gauche	00050841	1	-	-	-	-	00750841	-	-	-	-	1	-
BOITIER de serrure MELISSA blanche à fouillot 85 x 174 mm droite	00050830	1	-	-	-	-	00750830	-	-	-	-	1	-
BOITIER de serrure MELISSA blanche à fouillot 85 x 174 mm gauche	00050831	1	-	-	-	-	00750831	-	-	-	-	1	-

Non stocké/Non-stored/Producto no estocado - Sur stock Europe Zone 1 et Zone 2, nous consulter pour délai d'approvisionnement - Epuisement/Stock depletion/Agotamiento del stock

Serrure 3 points / BELUGA CP PROTECT



GARANTIE

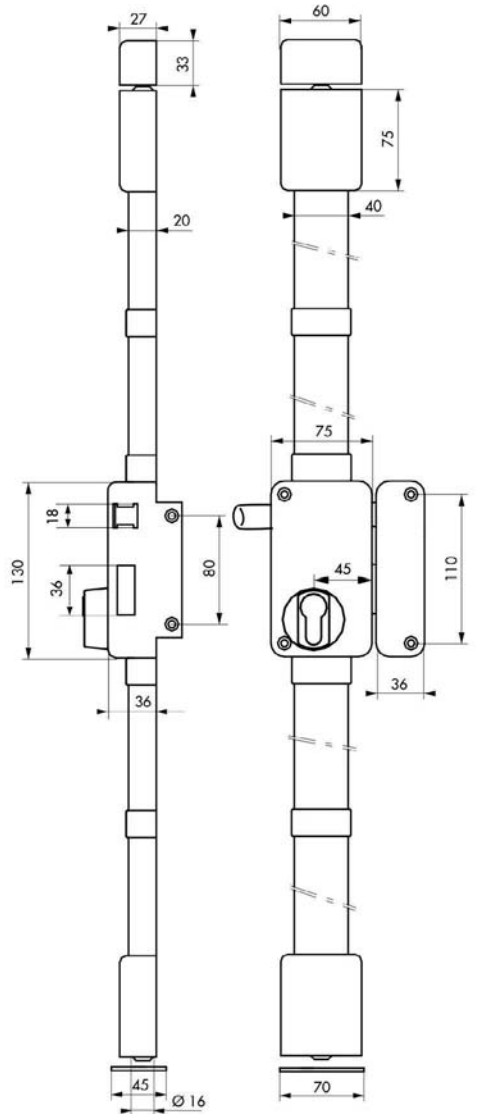

**Description/Description/Descripción**

Boîtier en acier embouti ép. 2 /10ème. Coffre de 75 x 130 mm, axe à 45 mm. Tringles standard permettant une condamnation de porte de 1,65 m à 2 2 m. Mécanisme intérieur type équerre permettant la manœuvre du 1/2 tour avec la clé, de l'intérieur comme de l'extérieur. Pêne dormant et 1/2 tour en laiton massif. Pênes haut et bas en acier Ø 16 mm sur tringles plates en acier permettant un ajustement très précis à la longueur désirée et ne nécessitant aucune recoupe. Gâche équerre de haute résistance. Cache-tringles, guides et gâches de pênes haut et bas en acier ne laissant apparaître aucune vis de fixation. Carré 7 mm - Poignée double fournie pour serrure à fouillot. Le montage de la serrure ne nécessite pas d'entaillage spécifique de la porte. Options : Jeu de tringles grande hauteur permettant un verrouillage jusqu'à 3,00?m. Poignée de tirage extérieure - Poignée simple laqué blanc ou marron - Protège-gonds. Kit gâche pour huisserie métallique, pour porte à recouvrement. Cylindre profilé TRANSIT 2 Cylindre à profil européen normalisé en laiton poli 30 x 65 mm pour porte de 45 mm. Mécanisme à 8 goupilles protégé contre le crochetage. Protection contre l'effraction de la partie saillante du cylindre (anti-snap). Panneton en acier fritté protégé contre l'arrachement. 4 clés plates réversibles en laiton nickelé avec carte de propriété. Possibilité de s'entrouvrant et organigramme.

Stamped steel case (thickness 20/10 th) 75 x 130 mm. Axis 45 mm. Standard rods for bolting door from 1,65 m to 2,25 m. Internal square mechanism. allowing the use of 1/2 turn with the key from inside as well as from outside. Steel up and down bolts Ø 16 mm with steel rods which can be adjusted at the good height without cutting rods. High resistant square striker. Rods guides and strikers up. and down steel protections. Hub cap of inside cylinder. Square 7 mm. Lock assembling without cutting the door. Supplied with double handle. Accessories : Rods kit for a maximum 3 m high door. Finger plate outside handle. Single handle . white or brown lacquered. Hinge protection. Striker kit for metal door frame. Striker kit for overlapping door Profile cylinder TRANSIT 2 Brass european profile cylinder 30 x 65 mm for 45 mm door thickness. 8 pin mechanism against picking, providing up to 410 000 combinations. Protection against the destruction of the projecting portion of the cylinder (anti-snap). Driver cam made of powered metal. Supplied with 4 reversible nickel plated steel keys with property title allowing exclusive reproduction of keys in the factory. Keyed alike and master key system available.

Caja de acero curvado de 20/10 de espesor. Caja de 75 x 130 mm, eje a 45 mm. Trancas estándar que permiten la condenación de una puerta de 1,65 a 2,25 m. Mecanismo interior de tipo escuadra que permite maniobrar la media vuelta con la llave, tanto desde el interior como desde el exterior. Pestillo durmiente y media vuelta de acero cincado bicromatado. Pestillo alto y bajo redondo en trancas de acero que permiten un ajuste muy preciso con la longitud deseada y que no precisan ningún corte. Cerradero de alta resistencia. Cubretrancas, guías y cerraderos de pestillos alto y bajo de acero que ocultan los tornillos de fijación, embellecedor de cilindro por el lado interior. Cuadrado 7 mm. Tirador doble suministrado para la cerradura de nuez. El montaje de las cerraduras no precisa una entalladura específica de la puerta. Juego de trancas de gran altura que permiten un cierre de hasta 3 m. Tirador exterior. Tirador simple de aluminio anodizado. Protector de goznes. Cilindro perfilado TRANSIT 2 Cilindro de perfil europeo normalizado de latón , de 30, 65 mm, para puerta de 45 mm. Mecanismo de 8 pasadores anti-forzamiento que permite 410.000 combinaciones. Protección contra la manipulación de la parte saliente de cilindro. Pivote de acero sinterizado antiarrancamiento. 4 llaves planas reversibles de latón. niquelado con título de propiedad que permite su reproducción en fábrica. Posibilidad de entreabrirse y. organigrama.

Finition/Finish/Acabado

Epoxy marron

Brown epoxy

Brown epoxy

Version/Option/Versión

Droite ou gauche. A TIRAGE ou à fouillot. Avec ou sans cylindre.

Right or left hand. Drawback pull or follwer type. With or without cylinder.

Derecha o izquierda. De tirador o de nuez. Con o sin cilindro.



Serrure 3 points / BELUGA CP

PROTECT



GARANTIE

Designation	Boite	Colis.	Prix	Sachet	Colis.	Prix	Brochable					Colis.	Prix
							France	Euro 1	Euro 2	Euro 3	Euro 4		
BOITIER de serrure BELUGA CP marron à tirage 75 x 130 mm droite	00049410	1	-	-	-	-	-	-	-	-	-	-	-
BOITIER de serrure BELUGA CP marron à tirage 75 x 130 mm gche	00049420	1	-	-	-	-	-	-	-	-	-	-	-
BOITIER de serrure BELUGA CP blanche à tirage 75 x 130 mm droite	00049411	1	-	-	-	-	-	-	-	-	-	-	-
BOITIER de serrure BELUGA CP blanche à tirage 75 x 130 mm gche	00049421	1	-	-	-	-	-	-	-	-	-	-	-
BOITIER de serrure BELUGA CP marron à fouillot 75 x 130 mm drte	00049510	1	-	-	-	-	-	-	-	-	-	-	-
BOITIER de serrure BELUGA CP marron à fouillot 75 x 130 mm gche	00049520	1	-	-	-	-	-	-	-	-	-	-	-
BOITIER de serrure BELUGA CP blanche à fouillot 75 x 130 mm drte	00049511	1	-	-	-	-	-	-	-	-	-	-	-
BOITIER de serrure BELUGA CP blanche à fouillot 75 x 130 mm gche	00049521	1	-	-	-	-	-	-	-	-	-	-	-
SERR. BELUGA marron CP TRANSIT 2 à tirage 75 x 130 drte 4 clés	-	-	-	-	-	-	00759410	-	-	-	-	1	-
SERR. BELUGA marron CP TRANSIT 2 à tirage 75 x 130 gche 4 clés	-	-	-	-	-	-	00759420	-	-	-	-	1	-
SERR. BELUGA blanche CP TRANSIT 2 à tirage 75 x 130 drte 4 clés	-	-	-	-	-	-	00759411	-	-	-	-	1	-
SERR. BELUGA blanche CP TRANSIT 2 à tirage 75 x 130 gche 4 clés	-	-	-	-	-	-	00759421	-	-	-	-	1	-
SERR. BELUGA marron CP TRANSIT 2 à fouillot 75 x 130 drte 4 clés	-	-	-	-	-	-	00759510	-	00792438	-	-	1	-
SERR. BELUGA marron CP TRANSIT 2 à fouillot 75 x 130 gche 4 clés	-	-	-	-	-	-	00759520	-	00792439	-	-	1	-
SERR. BELUGA blanche CP TRANSIT 2 à fouillot 75 x 130 drte 4 clés	-	-	-	-	-	-	00759511	-	00792440	-	-	1	-
SERR. BELUGA blanche CP TRANSIT 2 à fouillot 75 x 130 gche 4 clés	-	-	-	-	-	-	00759521	-	00792441	-	-	1	-
KIT TRINGLE PLATE blanc pour hauteur porte 3,00 m	00032321	1	-	-	-	-	-	-	-	-	-	-	-

NS Non stocké/Non-stored/Producto no estocado - S Sur stock Europe Zone 1 et Zone 2, nous consulter pour délai d'approvisionnement - E Epuisement/Stock depletion/Agotamiento del stock



Designation	Boite	Colis.	Prix	Sachet	Colis.	Prix	Brochable					Colis.	Prix
							France	Euro 1	Euro 2	Euro 3	Euro 4		
KIT TRINGLE PLATE marron pour hauteur porte 3,00 m	00032320	1	-	-	-	-	-	-	-	-	-	-	-
POIGNEE porte palière BELUGA CP époxy blanc CP droite	00007372	1	-	-	-	-	00207372	-	-	-	-	10	-
POIGNEE porte palière BELUGA CP époxy blanc CP gauche	00007382	1	-	-	-	-	00207382	-	-	-	-	10	-
POIGNEE porte palière BELUGA CP époxy marron CP droite	00006372	1	-	-	-	-	00206372	-	-	-	-	10	-
POIGNEE porte palière BELUGA CP époxy marron CP gauche	00006382	1	-	-	-	-	00206382	-	-	-	-	10	-
BEQUILLE double marron - 1 portée	00000490	1	-	-	-	-	-	-	-	-	-	-	-
BEQUILLE double blanc - 1 portée	00000491	1	-	-	-	-	-	-	-	-	-	-	-
BEQUILLE simple marron sans portée carré 7 long. 50mm avec arrêt	00012490	1	-	-	-	-	-	-	-	-	-	-	-
BEQUILLE simple blanc sans portée carré 7 long. 50mm avec arrêt	00012491	1	-	-	-	-	00200494	-	-	-	-	10	-
KIT D'ADAPTATION pour huisserie métallique droite blanc	-	-	-	-	-	-	00230322	-	-	-	-	1	-
KIT D'ADAPTATION pour huisserie métallique gauche blanc	-	-	-	-	-	-	00230323	-	-	-	-	1	-
KIT D'ADAPTATION pour huisserie métallique droite marron	-	-	-	-	-	-	00230324	-	-	-	-	1	-
KIT D'ADAPTATION pour huisserie métallique gauche marron	-	-	-	-	-	-	00230325	-	-	-	-	1	-
KIT D'ADAPTATION pour porte à recouvrement droite blanc	-	-	-	-	-	-	00230328	-	-	-	-	1	-
KIT D'ADAPTATION pour porte à recouvrement gauche blanc	-	-	-	-	-	-	00230329	-	-	-	-	1	-
KIT D'ADAPTATION pour porte à recouvrement droite marron	-	-	-	-	-	-	00230326	-	-	-	-	1	-
KIT D'ADAPTATION pour porte à recouvrement gauche marron	-	-	-	-	-	-	00230327	-	-	-	-	1	-
PROTEGE GONDS la paire	00025000	10	-	-	-	-	00225000	-	-	-	-	10	-



Serrure 3 points / TARGA CR A2P *

RESIST

Serrure reconnue
par les sociétés
d'assurances

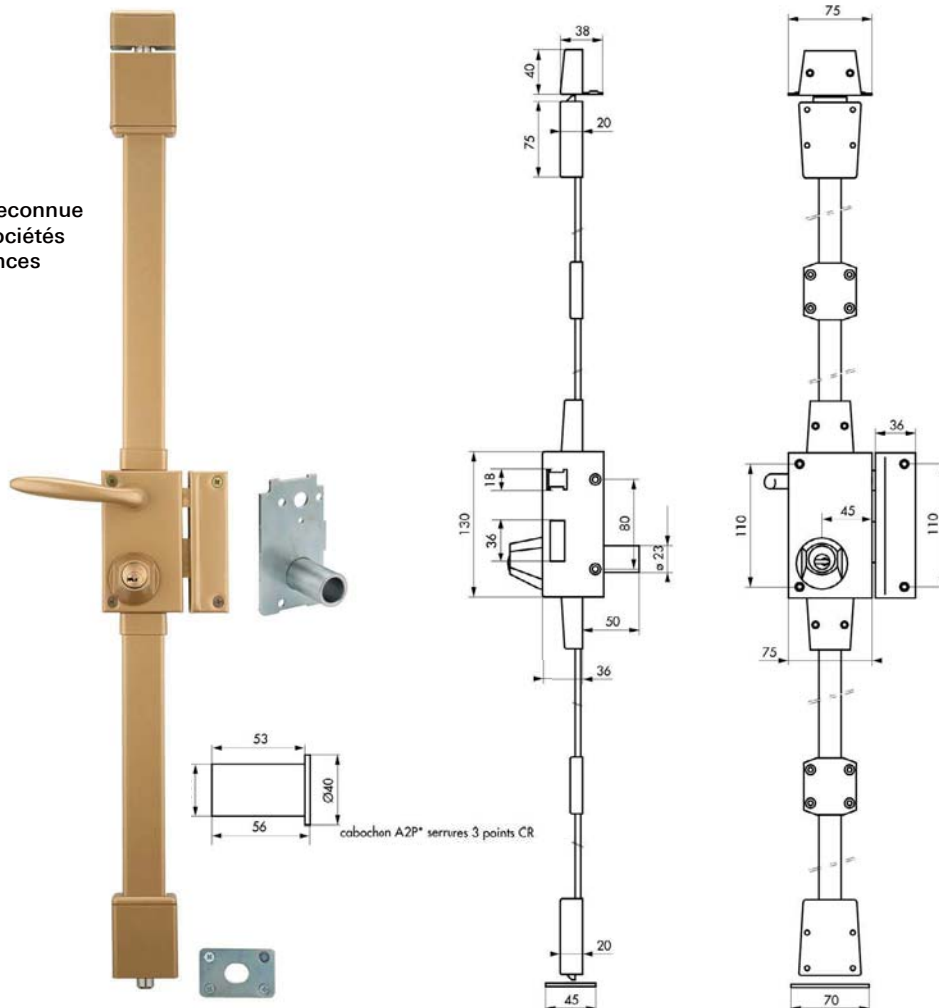

10
ans

GARANTIE



X 4

Description/Description/Descripción

Boîtier en acier cambré ép. 2 / 10 ème. Coffre cambré 75 x 130 mm, axe à 45 mm. Jeu de tringles pour une hauteur de porte de 2 m maxi. Mécanisme intérieur type équerre permettant la manœuvre du 1/ 2 tour de l'intérieur comme de l'extérieur avec la clé. Pêne et 1/ 2 tour en laiton massif Pêne haut et bas en acier zingué. Gâche avec têtère de haute résistance. Enjoliveur de cylindre côté intérieur. Carré 7 mm. Manœuvre de l'extérieur possible, même si une clé est restée dans la serrure à l'intérieur. Le montage de la serrure ne nécessite pas d'entaillage spécifique de la porte. Fourni avec béquille simple aluminium anodisé. Options : Kit de tringles pour une hauteur maximum de porte de 3 m. Ensemble porte palière. Béquille double aluminium anodisé. Protège-gonds. Equipements spécifiques de protection Plaque de renfort de la serrure. 2 goupilles en acier trempé dans le pêne dormant pour la protection contre le sciage. Cabochon de protection en acier contre l'arrachement du cylindre. 6 goupilles de protection contre le perçage du cylindre (stator / rotor) et 6 goupilles contre le crochetage en acier trempé. Cylindre rond Ø 2 mm. Mécanisme à 8 goupilles maillechort protégé

contre le crochetage. Pour épaisseur de porte de 45 mm maxi. 4 clés plates réversibles en laiton nickelé avec carte de propriété. Possibilité de s'ouvrant sur demande. Cambered steel case (thickness 20/10 th) 75 x 130 mm. Axis 45 mm. Rods kit for a door of maximum 2,25 m. Internal square mechanism allowing the use of latch bolt with the key from inside as well as from outside. Brass dead bolt and latch bolt. Up and down chrome plated steel bolts. High resistant striker. Hub cap for inside part of cylinder. Square 7 mm. Lock stays in use from outside even if a key is staying in the inside cylinder. Lock assembling without cutting the door. Supplied with anodized aluminium single handle. Accessories : Rods kit for a maximum 3 m high door. Finger plate outside handle. Anodized aluminium double handle. Hinge protection. Special fittings for protection. 2 anti-sawing pins in the dead bolt. Hardened steel turning cylinder guard. Anti-drilling pins in the cylinder. Hardened steel plate for the lock. Round cylinder Ø 23 mm. 8 pins mechanism against picking. Maximum door thickness 45 mm. Supplied with 4 reversible brass nickel plated keys with registration security card. Keyed alike.



Caja de acero curvado de 20/10 de espesor. Caja curvada de 75 x 130 mm, eje a 45 mm. Juego de trancas para una puerta con una altura máxima de 2,25 m. Mecanismo interior de tipo escuadra que permite maniobrar la media vuelta con la llave, tanto desde el interior como desde el exterior. Pestillo y media vuelta de latón macizo. Pestillo alto y bajo de acero cromado. Cerradero de alta resistencia. Embellecedor de cilindro por el lado interior. Cuadrado 7 mm. Posibilidad de maniobrar desde el exterior, aunque en el interior haya una llave en la cerradura. El montaje de la cerradura no precisa una entalladura específica de la puerta. Suministrada con un brazo simple de aluminio anodizado. Accesorios: Kit de trancas para una puerta con una altura máxima de 3 m. Conjunto de puerta descansillo. Brazo doble de aluminio anodizado. Protector de goznes. Equipamientos específicos de protección. Placa de refuerzo de la cerradura 2 pasadores de acero templado en el pestillo durmiente para la protección contra el aserrado. Cabujón de protección de

acero contra el arrancamiento del cilindro. 2 pasadores de protección contra el taladrado del cilindro (stator / rotor) y 3 primeros pasadores de acero templado Cilindro redondo - Ø 23 mm Mecanismo de 8 pasadores anti-forzamiento. Para una puerta con un espesor máximo de 45 mm. 4 llaves reversibles de latón niquelado con tarjeta de seguridad. Con posibilidad de entreabrirse.

Finition/Finish/Acabado

Epoxy bronze

Bronze epoxy

Epoxi bronce

Version/Option/Versión

Droite ou gauche. A TIRAGE ou à fouillot.

Right or left hand. Drawback pull or follver type.

Derecha o izquierda. De tirador o de nuez.

Designation	Boite	Colis.	Prix	Sachet	Colis.	Prix	Brochable					Colis.	Prix
							France	Euro 1	Euro 2	Euro 3	Euro 4		
SERR. TARGA bronze CR Ø 23 Transit 2 à tirage 75 x 130 drte 4 clés	00050210	1	-	-	-	-	00750210	-	-	-	-	1	-
SERR. TARGA bronze CR Ø 23 Transit 2 à tirage 75 x 130 gche 4 clés	00050220	1	-	-	-	-	00750220	-	-	-	-	1	-
SERR. TARGA bronze CR Ø 23 à Transit 2 à fouillot 75 x 130 drte 4 clés	00050310	1	-	-	-	-	00750310	-	-	-	-	1	-
SERR. TARGA bronze CR Ø 23 Transit 2 à fouillot 75 x 130 gche 4 clés	00050320	1	-	-	-	-	00750320	-	-	-	-	1	-
KIT TRINGLE pour serrure haut. porte 3 m, epoxy or	00032316	1	-	-	-	-	-	-	-	-	-	-	-
POIGNEE porte palière pour TARGA A2P* bronze Ø 30 mm droite	00002372	1	-	-	-	-	00202372	-	-	-	-	10	-
POIGNEE porte palière pour TARGA A2P* bronze Ø 30 mm gauche	00002382	1	-	-	-	-	00202382	-	-	-	-	10	-
BEQUILLE DOUBLE anodisé couleur F2 1 portée 7 long. 100 mm	00004479	1	-	-	-	-	-	-	-	-	-	-	-
PROTEGE GONDS la paire	00025000	10	-	-	-	-	00225000	-	-	-	-	10	-





GARANTIE



X 4

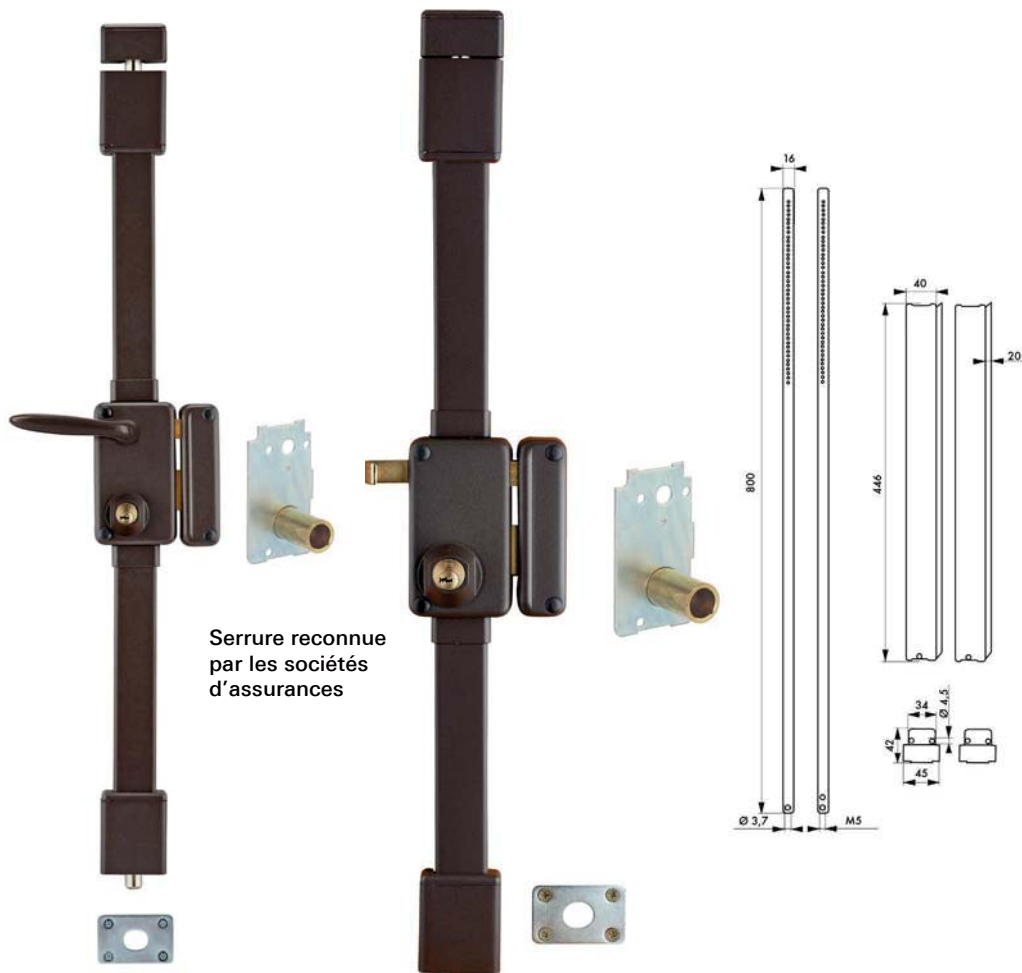

Serrure reconnue par les sociétés d'assurances

Description/Description/Descripción

Boîtier en acier embouti ép. 2 /10 ème. Coffre de 75 x 130 mm, axe à 45 mm. Tringles standard permettant une condamnation de porte de 1,65 m à 2 2 m. Mécanisme intérieur type équerre permettant la manœuvre du 1/ 2 tour avec la clé, de l'intérieur comme de l'extérieur. Pêne dormant et 1/ 2 tour en laiton. Pênes haut et bas ronds sur tringles en acier permettant un ajustement très précis à la longueur désirée et ne nécessitant aucune recoupe. Gâche équerre de haute résistance. Cache-tringles, guides et gâches de pênes haut et bas en acier ne laissant apparaître aucune vis de fixation. Enjoliveur de cylindre côté intérieur. Carré 7 mm. Poignée simple fournie pour serrure à fouillot. Le montage de la serrure ne nécessite pas d'entaillage spécifique de la porte. Options : Jeu de tringles grande hauteur permettant un verrouillage jusqu'à 3 m. Poignée de tirage extérieure - Béquille double . Protège-gonds. Equipements spécifiques de protection Plaque de renfort de la serrure. 2 goupilles en acier trempé dans le pêne dormant pour la protection contre le sciage. Cabochon de protection en acier contre l'arrachement du cylindre. 6 goupilles de protection contre le perçage du cylindre

(stator / rotor) et 6 goupilles contre le crochetaje en acier trempé. Cylindre rond Ø 2 mm Mécanisme à 8 goupilles maillechort protégé contre le crochetaje. Pour épaisseur de porte de 45 mm maxi. 4 clés plates réversibles en laiton nickelé avec carte de propriété. Possibilité de s'ouvrant sur demande.

Stamped steel case of 20/10 th. 75 x 130 mm - Axis 45 mm. Internal square mechanism allowing the use of 1/2 turn. with the key from inside as well as from outside. Brass dead bolt and latch bolt. Up and down round bolts with steel rods which can be adjusted at the good height without cutting rods. High resistant square striker. Rod protection, guide and strikers for up and down bolts in steel. Standard rods for bolting a door from 1,65 m to 2,25 m. Hub cap of inside cylinder. Square 7 mm. Lacquered brown, bronze or white locks available. Lock assembling without cutting the door. Single handle supplied for locks with follower. Accessories : Rods kit for a maximum 3 m high door. Finger plate outside handle. Double handle . Hinge protection. Special fittings for protection 2 anti-sawing pins in the dead bolt. Hardened steel turning cylinder guard. Anti-drilling pins in the cylinder.



RESIST

Hardened steel plate for the lock. Round cylinder Ø 23 mm 8 pins mechanism mechanism against picking. Maximum door thickness 45 mm. Supplied with 4 reversible brass nickel plated keys with registration security card. Keyed alike

Caja de acero embutido de 20/10 de espesor. Caja de 75 x 130 mm, eje a 45 mm. Trancas estándar que permiten la condenación de una puerta de 1,65 a 2,25 m. Mecanismo interior de tipo escuadra que permite maniobrar la media vuelta con la llave, tanto desde el interior como desde el exterior. Pestillo durmiente y media vuelta de latón. Pestillo alto y bajo redondo en trancas de acero que permiten un ajuste muy preciso con la longitud deseada y no necesita ningún corte. Cerradero de escuadra de alta resistencia. Cubretrancas, guías y cerraderos de pestillo alto y bajo de acero que ocultan los tornillos de fijación. Embellecedor de cilindro por el lado interior. Cuadrado 7 mm. Tirador simple suministrado para la cerradura de nuez. El montaje de la cerradura no precisa una entalladura específica de la puerta. Accesorios: Juego de trancas de gran altura. que permiten un cierre de hasta 3 m. Tirador exterior. Brazo

doble . Protector de goznes. Equipamientos específicos de protección Placa de refuerzo de la cerradura. 2 pasadores de acero templado en el pestillo durmiente para la protección contra el aserrado. Cabujón de protección de acero contra el arrancamiento del cilindro. 2 pasadores de protección contra el taladrado del cilindro (stator / rotor) y 3 primeros pasadores de acero templado. Cilindro redondo - Ø 23 mm Mecanismo de 8 pasadores anti-forzamiento. Para una puerta con un espesor máximo de 45 mm. 4 llaves reversibles de latón niquelado con tarjeta de seguridad. Con posibilidad de entreabrirse.

Finition/Finish/Acabado

Epoxy marron, bronze ou blanc

Bronze, brown or white epoxy

Epoxi bronce, blanco o marrón

Versión/Option/Versión

Droite ou gauche. A TIRAGE ou à fouillot.

Right or left hand. Drawback pull or follwer type.

Derecha o izquierda. De tirador o de nuez.

Designation	Boite	Colis.	Prix	Sachet	Colis.	Prix	Brochable					Colis.	Prix
							France	Euro 1	Euro 2	Euro 3	Euro 4		
SERR. BELUGA marron CR Ø 23 Transit 2 à tirage 75 x 130 drte 4 clés	-	-	-	-	-	-	00751812	-	-	-	-	1	-
SERR. BELUGA marron CR Ø 23 Transit 2 à tirage 75 x 130 gche 4 clés	-	-	-	-	-	-	00751822 NS	-	-	-	-	1	-
SERR. BELUGA marron CR Ø 23 Transit 2 à fouillot 75 x 130 drte 4 clés	-	-	-	-	-	-	00751912	-	-	-	-	1	-
SERR. BELUGA marron CR Ø 23 Transit 2 à fouillot 75 x 130 gche 4 clés	-	-	-	-	-	-	00751922 NS	-	-	-	-	1	-
KIT TRINGLE PLATE marron pour hauteur porte 3,00 m	00032320	1	-	-	-	-	-	-	-	-	-	-	-
POIGNEE porte palière pour BELUGA A2P* marron Ø 30 mm droite	00008372	1	-	-	-	-	00208372	-	-	-	-	10	-
POIGNEE porte palière pour BELUGA A2P* marron Ø 30 mm gauche	00008382	1	-	-	-	-	00208382	-	-	-	-	10	-
BEQUILLE double marron - 1 portée	00000490	1	-	-	-	-	-	-	-	-	-	-	-
BEQUILLE double blanc - 1 portée	00000491	1	-	-	-	-	-	-	-	-	-	-	-
BEQUILLE simple marron sans portée carré 7 long. 50mm avec arrêt	00012490	1	-	-	-	-	-	-	-	-	-	-	-
BEQUILLE simple blanc sans portée carré 7 long. 50mm avec arrêt	00012491	1	-	-	-	-	-	-	-	-	-	-	-
1/2 BEQUILLE marron - 1 portée carré 7100mm	-	-	-	-	-	-	00200494	-	-	-	-	10	-
PROTEGE GONDS la paire	00025000	10	-	-	-	-	00225000	-	-	-	-	10	-

NS Non stocké/Non-stored/Producto no estocado - Sur stock Europe Zone 1 et Zone 2, nous consulter pour délai d'approvisionnement - E Epuement/Stock depletion/Agotamiento del stock



RESIST



GARANTIE



X 4



Serrure reconnue
par les sociétés
d'assurances

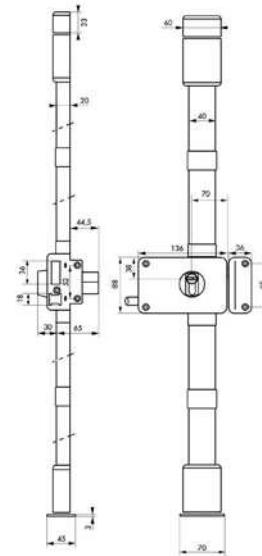

Description/Description/Descripción

Boîtier en acier embouti ép. 2 /10 ème. Coffre de 88 x 140 mm. Tringles standard permettant une condamnation de porte de 1,65 m à 2 2 m. Mécanisme intérieur type équerre permettant la manœuvre du 1/ 2 tour avec la clé, de l'intérieur comme de l'extérieur. Pêne dormant et 1/ 2 tour en laiton massif. Pênes haut et bas en acier Ø 16 mm sur tringles plates en acier permettant un ajustement très précis à la longueur désirée et ne nécessitant aucune recoupe. Gâche équerre de haute résistance. Cache-tringles, guides et gâches de pênes haut et bas en acier ne laissant apparaître aucune vis de fixation. Enjoliveur de cylindre côté intérieur. Carré 6 mm. Bouton simple fournie pour serrure à fouillot. Le montage de la serrure ne nécessite pas d'entailage spécifique de la porte. Options : Jeu de tringles grande hauteur permettant un verrouillage jusqu'à 3 m. Bouton double couleur du boîtier. Kit tringle. Equipements spécifiques de protection : Plaque de renfort de la serrure. 2 goupilles en acier trempé dans le pêne dormant pour la protection contre le sciage. Cabochon de protection en acier contre l'arrachement du cylindre. 2 goupilles de protection contre le perçage du cylindre (stator / rotor) et 3 premières goupilles en acier trempé. Cylindre profilé TRANSIT 2 : Cylindre à profil européen normalisé en laiton 30 x 65 mm pour porte de 45 mm maxi. Mécanisme à 8 goupilles protégé contre le crochetage. Panneton en acier fritté anti-arrachement. Protection contre le perçage par aiguille et goupille en acier trempé. 4 clés plates réversibles en laiton nickelé avec carte de propriété. Possibilité de s'entrouvrant sur demande.

Stamped steel case (thickness 20/10 th) 88 x 140 mm. Standard rods for bolting a door from 1,65 m to 2,25 m. Internal square mechanism allowing the use of 1/2 turn with the key from inside as well as from outside. Brass dead bolt and latch bolt. Steel up and down bolts Ø 16 mm with steel rods which can be adjusted at the good height without cutting rods. High resistant square striker. Rod protection, guide and strikers for up and down bolts in steel. Hub cap of inside cylinder. Square 6 mm.

Lock assembling without cutting the door. Rods kit for a maximum 3 m high door. Single handle white or brown lacquered delivered. Accessories : Hinge protection Special fittings for protection: 1 anti-sawing pin in the dead bolt. Hardened steel turning cylinder guard. Anti-drilling pins in the cylinder. Hardened steel plate for the lock. Profile cylinder TRANSIT 2: Brass european profile cylinder. 30 x 65 mm for 45 mm door thickness. 8 pin mechanism against picking. Driver cam made of powered metal. Protected with anti-drilling pins. Supplied with 4 reversible nickel plated steel keys with property title allowing exclusive reproduction of keys in the factory. Keyed alike. Caja de acero embutido de 20/10 de espesor. Caja de 88 x 140 mm. Trancas estándar que permiten la condenación de una puerta de 1,65 a 2,25 m. Mecanismo interior de tipo escuadra que permite maniobrar la media vuelta con la llave, tanto desde el interior como desde el exterior. Pestillo durmiente y media vuelta de latón macizo. Pestillo alto y bajo de acero, Ø 16 mm, en trancas de acero que permiten un ajuste muy preciso con la longitud deseada y que no necesita ningún corte. Cerrador de escuadra de alta resistencia. Cubretrancas, guías y cerraderos de pestillos alto y bajo de acero que ocultan los tornillos de fijación. Embellecedor de cilindro por el lado interior. Cuadrado 6 mm. Tirador simple suministrado para la cerradura de nuez. El montaje de la cerradura no precisa una entalladura específica de la puerta. Accesorios: Juego de trancas de gran altura que permiten un cierre de hasta 3 m. Brazo doble. Protector de goznes - Kit. Equipamientos específicos de protección: Placa de refuerzo de la cerradura. 2 pasadores de acero templado en el pestillo durmiente para la protección contra el aserrado. Cabujón de protección de acero contra el arrancamiento del cilindro. 2 pasadores de protección contra el taladrado del cilindro (stator / rotor) y 3 primeros pasadores de acero templado. Cilindro perfilado TRANSIT 2: Cilindro de perfil europeo normalizado de latón de 30 x 65 mm para puertas de 45 mm. Mecanismo de 8 pasadores anti-forzamiento. Pivote de acero sinterizado antiarrancamiento. Protección

contra el taladrado con una aguja y un pasador de acero templado. 4 llaves planas reversibles de latón niquelado con título de propiedad que perite la reproducción de las llaves exclusivamente en fábrica. Posibilidad de entreabrirse.

Finition/Finish/Acabado

Epoxy marron ou blanc

Brown or white epoxy

Epoxi marrón o blanco

Version/Option/Versión

Droite ou gauche. A TIRAGE ou à fouillot. Cylindre à profil européen normalisé en laiton 30 x 70 mm pour porte de 50 mm maxi.

Right or left hand. Drawback pull or follower type. Brass european profile cylinder 30 x 70 mm for 50 mm door thickness.

Derecha o izquierda - De tirador o de nuez. Cilindro de perfil europeo normalizado de latón de 30 x 70 mm para puertas de 50 mm.

Designation	Boite	Colis.	Prix	Sachet	Colis.	Prix	Brochable					Colis.	Prix
							France	Euro 1	Euro 2	Euro 3	Euro 4		
SERR. HORGА marron CP TRANSIT 2 à tirage 88 x 140 mm drte 4 clés pour porte de 45 mm maxi	00065015	1	-	-	-	-	00765015	-	-	-	-	1	-
SERR. HORGА marron CP TRANSIT 2 à tirage 88 x 140 mm gche 4 clés pour porte de 45 mm maxi	00065025	1	-	-	-	-	00765025	-	-	-	-	1	-
SERR. HORGА blanche CP TRANSIT 2 à tirage 88 x 140 mm drte 4 clés pour porte de 45 mm maxi	00065016	1	-	-	-	-	00765016	-	-	-	-	1	-
SERR. HORGА blanche CP TRANSIT 2 à tirage 88 x 140 mm gche 4 clés pour porte de 45 mm maxi	00065026	1	-	-	-	-	00765026	-	-	-	-	1	-
SERR. HORGА marron CP TRANSIT 2 à fouillot 88 x 140 mm drte 4 clés pour porte de 45 mm maxi	00065115	1	-	-	-	-	00765115	-	-	-	-	1	-
SERR. HORGА marron CP TRANSIT 2 à fouillot 88 x 140 mm gche 4 clés pour porte de 45 mm maxi	00065125	1	-	-	-	-	00765125	-	-	-	-	1	-
SERR. HORGА blanche CP TRANSIT 2 à fouillot 88 x 140 mm drte 4 clés pour porte de 45 mm maxi	00065116	1	-	-	-	-	00765116	-	-	-	-	1	-
SERR. HORGА blanche CP TRANSIT 2 à fouillot 88 x 140 mm gche 4 clés pour porte de 45 mm maxi	00065126	1	-	-	-	-	00765126	-	-	-	-	1	-
SERR. HORGА marron CP TRANSIT 2 à fouillot 88 x 140 mm drte 4 clés pour porte de 50 mm maxi	00065117	1	-	-	-	-	00765117	-	-	-	-	1	-
SERR. HORGА marron CP TRANSIT 2 à fouillot 88 x 140 mm gche 4 clés pour porte de 50 mm maxi	00065127	1	-	-	-	-	00765127	-	-	-	-	1	-
SERR. HORGА blanche CP TRANSIT 2 à fouillot 88 x 140 mm drte 4 clés pour porte de 50 mm maxi	00065118	1	-	-	-	-	00765118	-	-	-	-	1	-
SERR. HORGА blanche CP TRANSIT 2 à fouillot 88 x 140 mm gche 4 clés pour porte de 50 mm maxi	00065128	1	-	-	-	-	00765128	-	-	-	-	1	-
POIGNEE porte palière pour HORGА CP A2P* marron réversible	00012512	1	-	-	-	-	00212512	-	-	-	-	10	-
POIGNEE porte palière pour HORGА CP A2P* blanc réversible	00012513	1	-	-	-	-	00212513	-	-	-	-	10	-

Non stocké/Non-stored/Productos no estocados - Sur stock Europe Zone 1 et Zone 2, nous consulter pour délai d'approvisionnement - Epuement/Stock depletion/Agotamiento del stock





GARANTIE



X 4

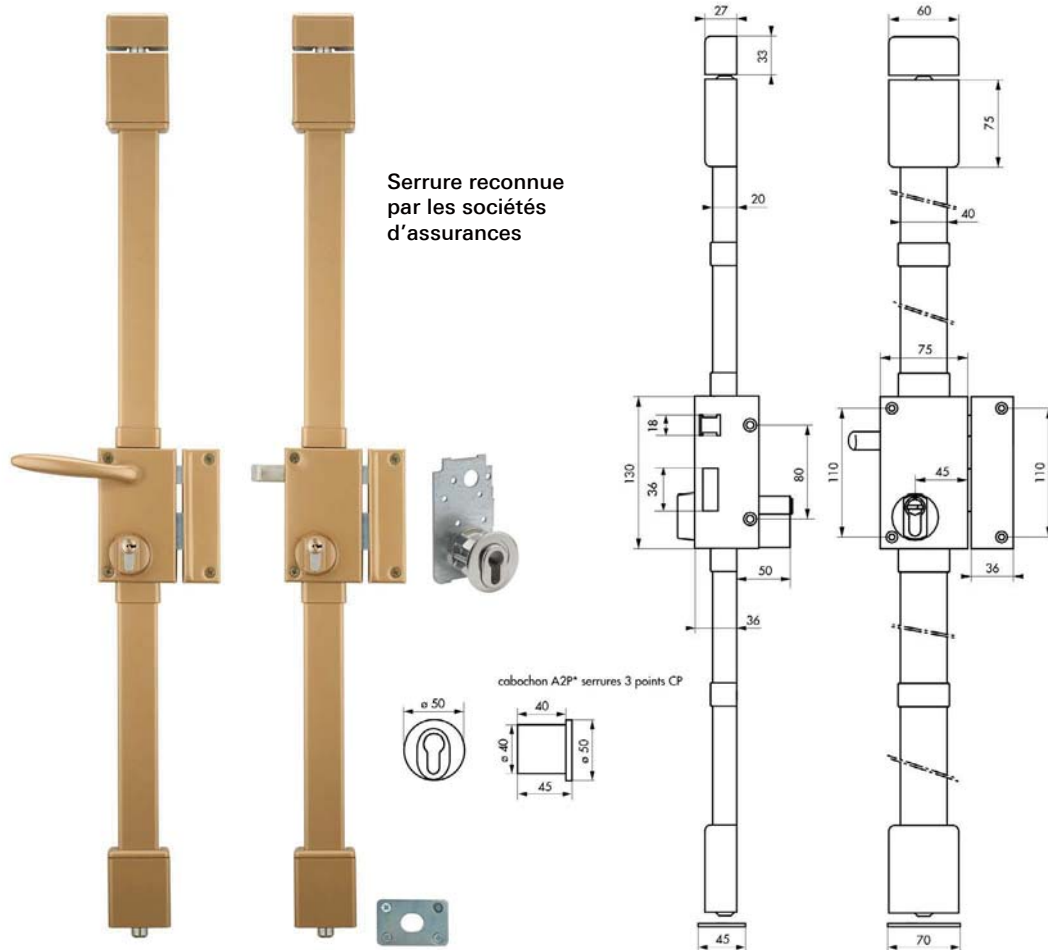

Serrure reconnue par les sociétés d'assurances

cabochon A2P* serrures 3 points CP

Description/Description/Descripción

Boîtier en acier cambré ép. 2 /10 ème. Coffre de 75 x 130 mm, axe à 45 mm. Tringles standard permettant une condamnation de porte de 1,65 m à 2 2 m. Mécanisme intérieur type équerre permettant la manœuvre du 1/2 tour avec la clé, de l'intérieur comme de l'extérieur. Pêne dormant et 1/2 tour en laiton massif. Pêne haut et bas rond en acier Ø 16 mm sur tringles plates permettant un ajustement très précis à la longueur désirée et ne nécessitant aucune recoupe. Gâche avec têtère de haute résistance. Cache-tringles, guides et gâches de pénès haut et bas. en acier ne laissant apparaître aucune vis de fixation. Enjoliveur de cylindre côté intérieur. Carré 7 mm. Fourni avec béquille simple anodisé couleur F 2 Le montage de la serrure ne nécessite pas d'entaillage spécifique de la porte. Options : Jeu de tringles grande hauteur permettant un verrouillage jusqu'à 3 m. Béquille double anodisé couleur F 2 Protège-gonds. Equipements spécifiques de protection. Plaque de renfort de la serrure. 2 goupilles en acier trempé dans le pêne dormant pour

la protection contre le sciage. Cabochon de protection en acier contre l'arrachement du cylindre. 2 goupilles de protection contre le perçage du cylindre (stator / rotor) et 3 premières goupilles en acier trempé. Cylindre profilé TRANSIT 2 cylindres à profil européen normalisé en laiton 30 x 65 mm pour porte de 45 mm. Mécanisme à 8 goupilles protégé contre le crochetage. Panneton en acier fritté anti-arrachement. Protection contre le perçage par aiguille et goupille en acier trempé. 4 clés plates réversibles en laiton nickelé avec carte de propriété. Possibilité de s'entrouvrant sur demande.

Cambered steel case of 20/10 th. 75 x 130 m - Axis 45 mm

Internal square mechanism allowing the use of 1/2 turn with the key from inside as well as from outside.

Brass dead bolt and latch bolt. Up and down Ø 16 mm steel bolts with steel rods which can be adjusted at the good height without cutting rods. High resistant striker. Rod protection, guide and strikers for up and down bolts in steel. Hub cap of inside cylinder. Square 7 mm. Lock assembling without particulary cutting the door.



Supplied with anodized single handle Accessories :Rods kit for a maximum 3 m high door. double handle. Hinge protection. Special fittings for protection.2 anti-sawing pins in the dead bolt. Hardened steel turning cylinder guard. Anti-drilling pins in the cylinder. Hardened steel plate for the lock. Profile cylinder TRANSIT 2Brass european profile cylinder. 30 x 65 mm for 45 mm door thickness. 8 pin mechanism against picking. Driver cam made of powered metal. Protected with anti-drilling pins. Supplied with 4 reversible nickel plated steel keys with property title allowing exclusive reproduction of keys in the factory. Keyed alike.

Caja de 75 x 130 mm, eje a 45 mm. Trancas estándar que permiten la condenación de una puerta de 1,65 a 2,25m. Mecanismo interior de tipo escuadra que permite maniobrar la media vuelta con la llave, tanto desde el interior como desde el exterior. Pestillo durmiente y media vuelta de latón macizo. Pestillo alto y bajo redondo de acero, Ø 16 mm, en trancas que permiten un ajuste muy preciso con la longitud deseada y que no necesita ningún corte. Cerradero de alta resistencia. Cubretrancas, guías y cerraderos de pestillos alto y bajo de acero que ocultan los tornillos de fijación. Embellecedor de cilindro por el lado interior. Cuadrado 77mm. Posibilidad de maniobrar desde el interior, aunque por dentro haya una llave en el cilindro. El montaje de la cerradura no precisa una entalladura específica de la puerta. Suministrado con brazo simple anodizado champán. Accesorios:Juego de trancas de gran altura que permiten un cierre de hasta 3 m. Brazo doble anodizado champán. Protector de goznes.

Equipamientos específicos de protección Placa de refuerzo de la cerradura. 2 pasadores de acero templado en el pestillo durmiente para la protección contra el aserrado. Cabujón de protección de acero contra el arrancamiento del cilindro. 2 pasadores de protección contra el taladrado del cilindro (stator / rotor) y 3 primeros pasadores de acero templado. Cilindro perfilado TRANSIT 2 Cilindro de perfil europeo normalizado de latón, de 30 x 65 mm para puertas de 45 mm. Mecanismo de 8 pasadores anti-forzamiento. Pivote de acero sinterizado antiarrancamiento. Protección contra el taladrado mediante una aguja y un pasador de acero templado. 4 llaves planas reversibles de latón niquelado con título de propiedad que permite la reproducción de las llaves. exclusivamente en fábrica. Posibilidad de entreabrirse.

Finition/Finish/Acabado

Epoxy bronze

Bronze epoxy

Epoxi bronce

Version/Option/Versión

Droite ou gauche. A TIRAGE ou à fouillotCylindre à profil européen normalisé en laiton 30 x 70 mm pour porte de 50 mm maxi.

Right or left hand. Drawback pull or follower type. Brass european profile cylinder 30 x 70 mm for 50 mm door thickness.

Derecha o izquierda - De tirador o de nuez. Cilindro de perfil europeo normalizado de latón, de 30 x 70 mm para puertas de 50 mm.

Designation	Boite	Colis.	Prix	Brochable				Colis.	Prix
				France	Euro 1	Euro 2	Euro 3		
SERR. TARGA bronze CP TRANSIT 2 à tirage 75 x 130 mm drte 4 clés	00053012	1	-	00753010	-	-	-	1	-
SERR. TARGA bronze CP TRANSIT 2 à tirage 75 x 130 mm gche 4 clés	00053020	1	-	00753020	-	-	-	1	-
SERR. TARGA bronze CP TRANSIT 2 à fouillot 75 x 130 mm drte 4 clés	00053110	1	-	00753110	-	-	-	1	-
SERR. TARGA bronze CP TRANSIT 2 à fouillot 75 x 130 mm gche 4 clés	00053120	1	-	00753120	-	-	-	1	-
SERR. TARGA bronze CP TRANSIT 2 porte ép.50 à fouillot 75 x 130 mm drte 4 clés	00053111	1	-	-	-	-	-	-	-
SERR. TARGA bronze CP TRANSIT 2 porte ép.50 à fouillot 75 x 130 mm gche 4 clés	00053121	1	-	-	-	-	-	-	-
KIT TRINGLE PLATE pour hauteur porte 3,00 m, epoxy or	00032316	1	-	-	-	-	-	-	-
BEQUILLE DOUBLE 1 portée carré 7mm long. 100 mm	00004479	1	-	-	-	-	-	-	-
BEQUILLE SIMPLE sans portée carré 7mm avec arrêt long. 50 mm	00014479	1	-	-	-	-	-	-	-
POIGNEE porte palière pour TARGA A2P* bronze réversible	00014188	1	-	00214188	-	-	-	10	-
PROTEGE GONDS la paire	00025000	10	-	00225000	-	-	-	10	-



Serrure 3 points / BELUGA CP **A2P***

RESIST



Serrure reconnue par les sociétés d'assurances

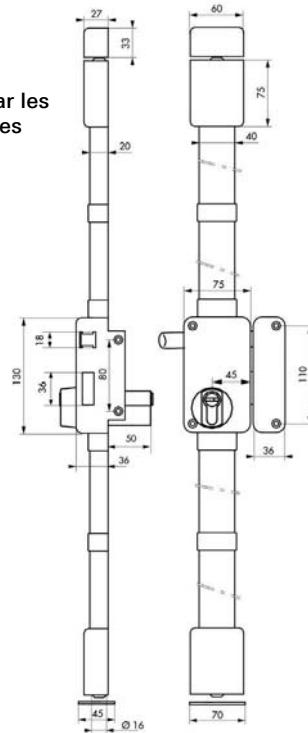

GARANTIE



X 4

Description/Description/Descripción

Boîtier en acier embouti ép. 2 /10 ème. Coffre de 75 x 130 mm, axe à 45 mm. Tringles standard permettant une condamnation de porte de 1,65 m à 2 2 m. Mécanisme intérieur type équerre permettant la manœuvre du 1/2 tour avec la clé, de l'intérieur comme de l'extérieur. Pêne dormant et 1/2 tour en laiton massif. Pênes haut et bas en acier Ø 16 mm sur tringles plates en acier permettant un ajustement très précis à la longueur désirée et ne nécessitant aucune recoupe. Gâche équerre de haute résistance. Cache-tringles, guides et gâches de pênes haut et bas en acier ne laissant apparaître aucune vis de fixation. Enjoliveur de cylindre côté intérieur. Carré 7 mm. Poignée simple fournie pour serrure à fouillot. Le montage de la serrure ne nécessite pas d'entallage spécifique de la porte Options : Jeu de tringles grande hauteur permettant un verrouillage jusqu'à 3 m. Béquille double . Protège-gonds. Kit tringle.Equipements spécifiques de protectionPlaque de renfort de la serrure. 2 goupilles en acier trempé dans le pêne dormant pour la protection contre le sciage. Cabochon de protection en acier contre l'arrachement du cylindre. 2 goupilles de protection contre le perçage du cylindre (stator / rotor) et 3 premières goupilles en acier trempé. Cylindre profilé TRANSIT 2 cylindres à profil européen normalisé en laiton 30 x 65 mm pour porte de 45 mm maxi. Mécanisme à 8 goupilles protégé contre le crochetage. Panneton en acier fritté anti-arrachement. Protection contre le perçage par aiguille et goupille en acier trempé. 4 clés plates réversibles en laiton nickelé avec carte de propriété. Possibilité de s'ouvrant sur demande. Stamped steel case (thickness 20/10 th) 75 x 130 mm. Axis 45 mm. Standard rods for bolting a door from 1,65 m to 2,25 m. Internal square mechanism allowing the use of

1/2 turn with the key from inside as well as from outside. Brass dead bolt and latch bolt. Steel up and down bolts Ø 16 mm with steel rods which can be adjusted at the good height without cutting rods. High resistant square striker. Rod protection, guide and strikers for up and down bolts in steel. Hub cap of inside cylinder. Square 7 mm. Lock assembling without cutting the door. Rods kit for a maximum 3 m high door. Single handle white or brown lacquered delivered. Accessories : Hinge protectionSpecial fittings for protection. 1 anti-sawing pin in the dead bolt. Hardened steel turning cylinder guard. Anti-drilling pins in the cylinder. Hardened steel plate for the lock. Profile cylinder TRANSIT 2 Brass european profile cylinder 30 x 65 mm for 45 mm door thickness. 8 pin mechanism against picking. Driver cam made of powered metal. Protected with anti-drilling pins. Supplied with 4 reversible nickel plated steel keys with property title allowing exclusive reproduction of keys in the factory. Keyed alike.

Caja de acero embutido de 20/10 de espesor. Caja de 75 x 130 mm, eje a 45 mm. Trancas estándar que permiten la condenación de una puerta de 1,65 a 2,25 m. Mecanismo interior de tipo escuadra que permite maniobrar la media vuelta con la llave, tanto desde el interior como desde el exterior. Pestillo durmiente y media vuelta de latón macizo. Pestillo alto y bajo de acero, Ø 16 mm, en trancas de acero que permiten un ajuste muy preciso con la longitud deseada y que no necesita ningún corte. Cerradero de escuadra de alta resistencia. Cubretrancas, guías y cerraderos de pestillos alto y bajo de acero que ocultan los tornillos de fijación. Embellecedor de cilindro por el lado interior. Cuadrado 7 mm. Tirador simple suministrado para la cerradura de nuez. El montaje de la cerradura no precisa una entalladura específica de la puerta. Accesorios: Juego de

trancas de gran altura que permiten un cierre de hasta 3 m. Brazo doble . Protector de goznes - KitEquipamientos específicos de protección Placa de refuerzo de la cerradura. 2 pasadores de acero templado en el pestillo durmiente para la protección contra el aserrado. Cabujón de protección de acero contra el arrancamiento del cilindro. 2 pasadores de protección contra el taladrado del cilindro (stator / rotor) y 3 primeros pasadores de acero templado. Cilindro perfilado TRANSIT 2 Cilindro de perfil europeo normalizado de latón de 30 x 65 mm para puertas de 45 mm. Mecanismo de 8 pasadores anti-forzamiento. Pivote de acero sinterizado antiarrancamiento. Protección contra el taladrado con

una aguja y un pasador de acero templado. 4 llaves planas reversibles de latón niquelado con título de propiedad que permite la reproducción de las llaves exclusivamente en fábrica. Posibilidad de entreabrirse.

Finition/Finish/Acabado

Epoxy marron ou blanc

Brown or white epoxy

Epoxi marrón o blanco

Version/Option/Versión

Droite ou gauche. A TIRAGE ou à fouillot.

Right or left hand. Drawback pull or follwer type.

Derecha o izquierda. De tirador o de nuez.

Designation	Boite	Colis.	Prix	Sachet	Colis.	Prix	Brochable					Colis.	Prix
							France	Euro 1	Euro 2	Euro 3	Euro 4		
SERR. BELUGA marron CP TRANSIT 2 à tirage 75 x 130 mm drte 4 clés	00055030	1	-	-	-	-	00755010	-	-	-	-	1	-
SERR. BELUGA marron CP TRANSIT 2 à tirage 75 x 130 mm gauche 4 clés	00055020	1	-	-	-	-	00755020	-	-	-	-	1	-
SERR. BELUGA blanche CP TRANSIT 2 à tirage 75 x 130 mm droite 4 clés	00055031	1	-	-	-	-	00755011	-	-	-	-	1	-
SERR. BELUGA blanche CP TRANSIT 2 à tirage 75 x 130 mm gauche 4 clés	00055021	1	-	-	-	-	00755021	-	-	-	-	1	-
SERR. BELUGA marron CP TRANSIT 2 à fouillot 75 x 130 mm droite 4 clés	00055110	1	-	-	-	-	00755110	-	-	-	-	1	-
SERR. BELUGA marron CP TRANSIT 2 à fouillot 75 x 130 mm gauche 4 clés	00055120	1	-	-	-	-	00755120	-	-	-	-	1	-
SERR. BELUGA blanche CP TRANSIT 2 à fouillot 75 x 130 mm droite 4 clés	00055111	1	-	-	-	-	00755111	-	-	-	-	1	-
SERR. BELUGA blanche CP TRANSIT 2 à fouillot 75 x 130 mm gauche 4 clés	00055121	1	-	-	-	-	00755121	-	-	-	-	1	-
KIT TRINGLE PLATE blanc pour hauteur porte 3,00 m	00032321	1	-	-	-	-	-	-	-	-	-	-	-
KIT TRINGLE PLATE marron pour hauteur porte 3,00 m	00032320	1	-	-	-	-	-	-	-	-	-	-	-
POIGNEE porte-palière pour TRIBANDO A2P* blanc réversible	00014189	1	-	-	-	-	00214189 E	-	-	-	-	10	-
BEQUILLE double marron - 1 portée	00000490	1	-	-	-	-	-	-	-	-	-	-	-
BEQUILLE double blanc - 1 portée	00000491	1	-	-	-	-	-	-	-	-	-	-	-
BEQUILLE simple marron sans portée carré 7 long. 50mm avec arrêt	00012490	1	-	-	-	-	-	-	-	-	-	-	-
BEQUILLE simple blanc sans portée carré 7 long. 50mm avec arrêt	00012491	1	-	-	-	-	-	-	-	-	-	-	-
1/2 BEQUILLE marron - 1 portée carré 7100mm	-	-	-	-	-	-	00200494	-	-	-	-	10	-
PROTEGE GONDS la paire	00025000	10	-	-	-	-	00225000	-	-	-	-	10	-

Non stocké/Non-stored/Producto no estocado - Sur stock Europe Zone 1 et Zone 2, nous consulter pour délai d'approvisionnement - E Epuement/Stock depletion/Agotamiento del stock





GARANTIE



X 4

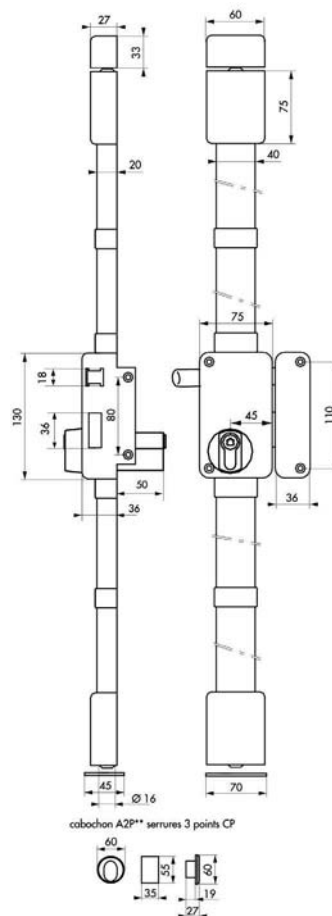

Description/Description/Descripción

Boîtier en acier embouti ép. 2 /10 ème. Coffre de 75 x 130 mm, axe à 45 mm. Tringles standard permettant une condamnation de porte de 1,65 m à 2 2 m. Mécanisme intérieur type équerre permettant la manœuvre du 1/ 2 tour avec la clé, de l'intérieur comme de l'extérieur. Pêne dormant et 1/ 2 tour en laiton massif. Pênes haut et bas en acier Ø 16 mm sur tringles plates en acier permettant un ajustement très précis à la longueur désirée et ne nécessitant aucune recoupe. Gâche équerre de haute résistance. Cache-tringles, guides et gâches de pênes haut et bas en acier ne laissant apparaître aucune vis de fixation. Enjoliveur de cylindre côté intérieur. Carré 7 mm. Fourni avec poignée palière. Options : Jeu de tringles grande hauteur permettant un verrouillage jusqu'à 3 m. Protège-gonds. Equipements spécifiques de protection Goupilles en acier trempé dans les pênes haut, bas et pêne dormant contre le sciage. Cabocho de protection du cylindre en acier contre l'arrachement et tube contre l'introduction d'outils. Plaque acier avec pastilles en acier trempé contre le perçage du coffre. 2 pastilles acier trempé contre le perçage du cylindre. Gâche avec pilier guide pêne en appui sur une câble de renfort. Cylindre profilé PACIFIC Profil européen normalisé en laiton nickelé. 31 x 56 mm pour porte de 45 mm maxi. Mécanisme de haute sûreté à 5 pompes axiales anticrochetage. Dispositif pompe - contre-pompe de sécurité radiale. Protection contre le perçage par aiguille

et goupille en acier trempé. Panneton en acier fritté anti-arrachement. Système anti-éjection de la clé. 4 clés ergonomiques brevetées avec carte de propriété assurant la reproduction des clés en usine. Possibilité de s'entrouvrant sur demande

Stamped steel case of 20/10 th. 75 x 130 mm - Axis 45 mm. Strengthened striker. Standard rods for bolting a door from 1,65 m to 2,25 m. Internal square mechanism allowing the use of 1/2 turn with the key from inside as well as from outside. Brass dead bolt and latch bolt. Up and down round bolts Ø 16 mm with steel rods which can be adjusted at the good height without cutting rods. High resistant square striker. Hardened rods protection, guide and strikers for up and down bolts in steel. Hub cap of inside cylinder. Square 7 mm. Supplied with finger plate outside handle. Accessories : Rods kit for a maximum 3 m high door. Hinge protection Special fittings for protection Hardened pins in up and down bolts and dead bolt against sawing. Hardened steel turning cylinder guard. Strong plate with anti-drilling pins for the lock. Profile cylinder PACIFIC European nickel plated brass profile with pump mechanism 31 x 56 mm for 45 mm door thickness. High security mechanism 5 axial tumblers with anti-picking tumbler device and against radial security tumbler. Anti-ejection system for the key. Supplied with 4 patentd ergonomic keys with a personal security card for key copies. Keyed alike.



Caja de acero embutido de 20/10 de espesor. Caja de 75 x 130 mm, eje a 45 mm. Trancas estándar que permiten la condensación de una puerta de 1,65 a 2,25 m. Mecanismo interior de tipo escuadra que permite maniobrar la media vuelta con la llave, tanto desde el interior como desde el exterior. Pestillo durmiente y media vuelta de latón macizo. Pestillo alto y bajo de acero, Ø 16 mm, en trancas de acero que permiten un ajuste muy preciso con la longitud deseada y no necesita ningún corte. Cerradero de escuadra de alta resistencia. Cubretrancas, guías y cerraderos de pestillo alto y bajo de acero que ocultan los tornillos de fijación. Embellecedor de cilindro por el lado interior. Cuadrado 7 mm. Suministrado con tirador de descansillo. Accesorios: Juego de trancas de gran altura que permiten un cierre de hasta 3 m. Protector de goznes. Equipamientos específicos de protección Pasadores de acero templado en los pestillos alto, bajo y el pestillo durmiente contra el aserrado. Cabujón de protección del cilindro de acero contra el arrancamiento y tubo contra la introducción de una herramienta. Placa de acero con pastillas de acero templado contra el

taladrado de la caja. 2 pastillas de acero templado contra el taladrado del cilindro. Cerradero con pilar guía de pestillo apoyado en un calce de refuerzo. Cilindro perfilado PACIFIC Perfil europeo normalizado de latón niquelado. Mecanismo inviolable de alta seguridad de 5 bombas axiales. 31 x 56 mm para puertas de 45 mm. Dispositivo de bomba - contrabomba de seguridad radial. Protección contra el taladrado con una aguja y un pasador de acero templado. Pivote de acero sinterizado antiarrancamiento. Sistema antieyección de la llave. 4 llaves ergonómicas patentadas con título de propiedad que garantizan su reproducción en la fábrica. Con posibilidad de entreabrirse.

Finition/Finish/Acabado

Epoxy marron ou blanc

Brown or white epoxy

Epoxi marrón o blanco

Version/Option/Versión

Droite ou gauche. A TIRAGE ou à fouillot.

Right or left hand. Drawback pull or follwer type.

Right or left hand. Drawback pull or follwer type.

Designation	Boite	Colis.	Prix	Sachet	Colis.	Prix	Brochable					Colis.	Prix
							France	Euro 1	Euro 2	Euro 3	Euro 4		
SERR. BELUGA marron CP à tirage 75 x 130 mm drte 4 clés	00052810	1	-	-	-	-	00752810	-	-	-	-	1	-
SERR. BELUGA marron CP à tirage 75 x 130 mm gche 4 clés	00052820	1	-	-	-	-	00752820	-	-	-	-	1	-
SERR. BELUGA blanche CP à tirage 75 x 130 mm drte 4 clés	00052811	1	-	-	-	-	00752811	-	-	-	-	1	-
SERR. BELUGA blanche CP à tirage 75 x 130 mm gche 4 clés	00052821	1	-	-	-	-	00752821	-	-	-	-	1	-
SERR. BELUGA marron CP à fouillot 75 x 130 mm drte 4 clés	00052910	1	-	-	-	-	00752910	-	-	-	-	1	-
SERR. BELUGA marron CP à fouillot 75 x 130 mm gche 4 clés	00052920	1	-	-	-	-	00752920	-	-	-	-	1	-
SERR. BELUGA blanche CP à fouillot 75 x 130 mm drte 4 clés	00052911	1	-	-	-	-	00752911	-	-	-	-	1	-
SERR. BELUGA blanche CP à fouillot 75 x 130 mm gche 4 clés	00052921	1	-	-	-	-	00752921	-	-	-	-	1	-
KIT TRINGLE PLATE blanc pour hauteur porte 3,00 m	00032321	1	-	-	-	-	-	-	-	-	-	-	-
KIT TRINGLE PLATE marron pour hauteur porte 3,00 m	00032320	1	-	-	-	-	-	-	-	-	-	-	-
PROTEGE GONDS la paire	00025000	10	-	-	-	-	00225000	-	-	-	-	10	-



Serrure 3 points / A CLE DOUBLE PANNETON PROTECT

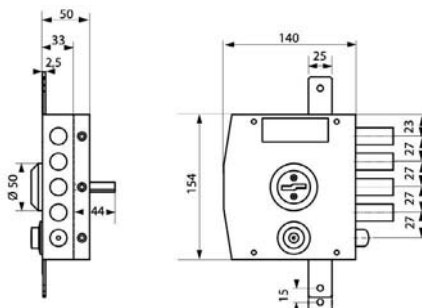

Description/Description/Descripción

Coffre et gâche acier. Fermeture à 2 tours. Rappel du 1/2 tour par la clé. Pênes diam. 18mm. 3 clés.
Steel case and striker. Double latch mechanism. Drawback of the latch by key. 18mm steel bolts. 3 keys.
 Caja y cerradero de acero. Mecanismo de 2 vueltas. Reposicion de la media vuelta con la llave. Pestillos de acero diam.18mm. 3 llaves

Finition/Finish/Acabado

Epoxy / Epoxy / Epoxi
Version/Option/Versión
 Droite ou gauche.
Right or left hand.
 Derecha o izquierda.



GARANTIE



X 3

Designation	Boite	Colis.	Prix	Brochable				Colis.	Prix
				France	Euro 1	Euro 2	Euro 3		
Serrure 3 points à clé double panneton 1/2 tour droite 3 clés	00063940	1	-	-	-	-	-	-	-
Serrure 3 points à clé double panneton 1/2 tour gauche 3 clés	00063941	1	-	-	-	-	-	-	-
Jeu de barres haut et bas	00063948	1	-	-	-	-	-	-	-

Serrure 3 points / A BOUTON ET CYLINDRE ROND PROTECT

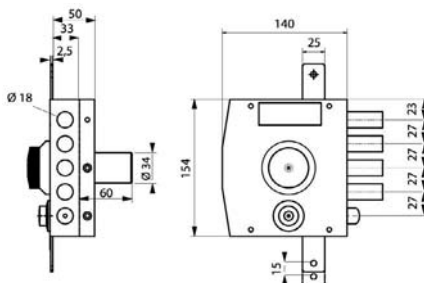

Description/Description/Descripción

Coffre et gâche acier. Fermeture à 2 tours. Rappel du 1/2 tour par la clé. Pênes diam. 18mm. Protection du cylindre par cabochon acier. 5 clés.
Steel case and striker. Double latch mechanism. Drawback of the latch by key. 18mm steel bolts. Steel turning cylinder guard. 5 keys.
 Caja y cerradero de acero. Mecanismo de 2 vueltas. Reposicion de la media vuelta con la llave. Pestillos de acero diam.18mm. Cabujon de protection de acero del cilindro. 5 llaves

Finition/Finish/Acabado

Epoxy / Epoxy / Epoxi
Version/Option/Versión
 Droite ou gauche.
Right or left hand.
 Derecha o izquierda.



GARANTIE



X 5

Designation	Boite	Colis.	Prix	Brochable				Colis.	Prix
				France	Euro 1	Euro 2	Euro 3		
Serrure 3 points à bouton et CR TRANSIT 2 1/2 tour droite 5 clés	00063942	1	-	-	-	-	-	-	-
Serrure 3 points à bouton et CR TRANSIT 2 1/2 tour gauche 5 clés	00063943	1	-	-	-	-	-	-	-
Jeu de barres haut et bas	00063948	1	-	-	-	-	-	-	-

Serrure 3 points / A DOUBLE CYLINDRE ROND

PROTECT

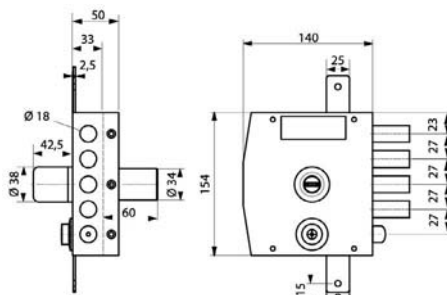

GARANTIE



X 5

Description/Description/Descripción

Coffre et gâche acier. Fermeture à 2 tours. Rappel du 1/2 tour par la clé. Pênes diam. 18mm. Protection du cylindre par cabochon acier. 5 clés.

Steel case and striker. Double latch mechanism.

Drawback of the latch by key. 18mm steel bolts. Steel turning cylinder guard. 5 keys.

Caja y cerradero de acero. Mecanismo de 2 vueltas.

Reposicion de la media vuelta con la llave. Pestillos de acero diam.18mm. Cabujon de proteccion de acero del cilindro. 5 llaves

Finition/Finish/Acabado

Epoxy / Epoxy / Epoxi

Version/Option/Versión

Droite ou gauche.

Right or left hand.

Derecha o izquierda.

Designation	Boite	Colis.	Prix	Brochable				Colis.	Prix
				France	Euro 1	Euro 2	Euro 3		
Serrure 3 points à double CR TRANSIT 2 1/2 tour droite 5 clés	00063944	1	-	-	-	-	-	-	-
Serrure 3 points à double CR TRANSIT 2 1/2 tour gauche 5 clés	00063945	1	-	-	-	-	-	-	-
Jeu de barres haut et bas	00063948	1	-	-	-	-	-	-	-

Serrure 3 points / BOITIER POUR CYLINDRE PROFILÉ

PROTECT

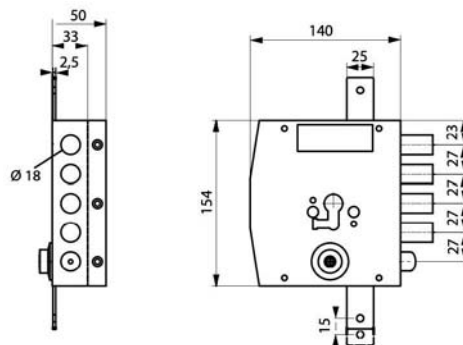

GARANTIE

Description/Description/Descripción

Coffre et gâche acier. Fermeture à 2 tours. Rappel du 1/2 tour par la clé. Pênes diam. 18mm. Pour cylindre pro

Steel case and striker. Double latch mechanism.

Drawback of the latch by key. 18mm steel bolts. For european pro cylinder.

Caja y cerradero de acero. Mecanismo de 2 vueltas.

Reposicion de la media vuelta con la llave. Pestillos de acero diam.18mm. Para cilindro pereuropeo.

Finition/Finish/Acabado

Epoxy / Epoxy / Epoxi

Version/Option/Versión

Droite ou gauche.

Right or left hand.

Derecha o izquierda.

Designation	Boite	Colis.	Prix	Brochable				Colis.	Prix
				France	Euro 1	Euro 2	Euro 3		
Boitier de serrure 3 points CP 1/2 tour droite	00063946	1	-	-	-	-	-	-	-
Boitier de serrure 3 points CP 1/2 tour gauche	00063947	1	-	-	-	-	-	-	-
Jeu de barres haut et bas	00063948	1	-	-	-	-	-	-	-

Non stocké/Non-stored/Producto no estocado - Sur stock Europe Zone 1 et Zone 2, nous consulter pour délai d'approvisionnement - Epuisement/Stock depletion/Agotamiento del stock

Serrure en applique 3 points / TRIBANDO

PROTECT



GARANTIE



X 4

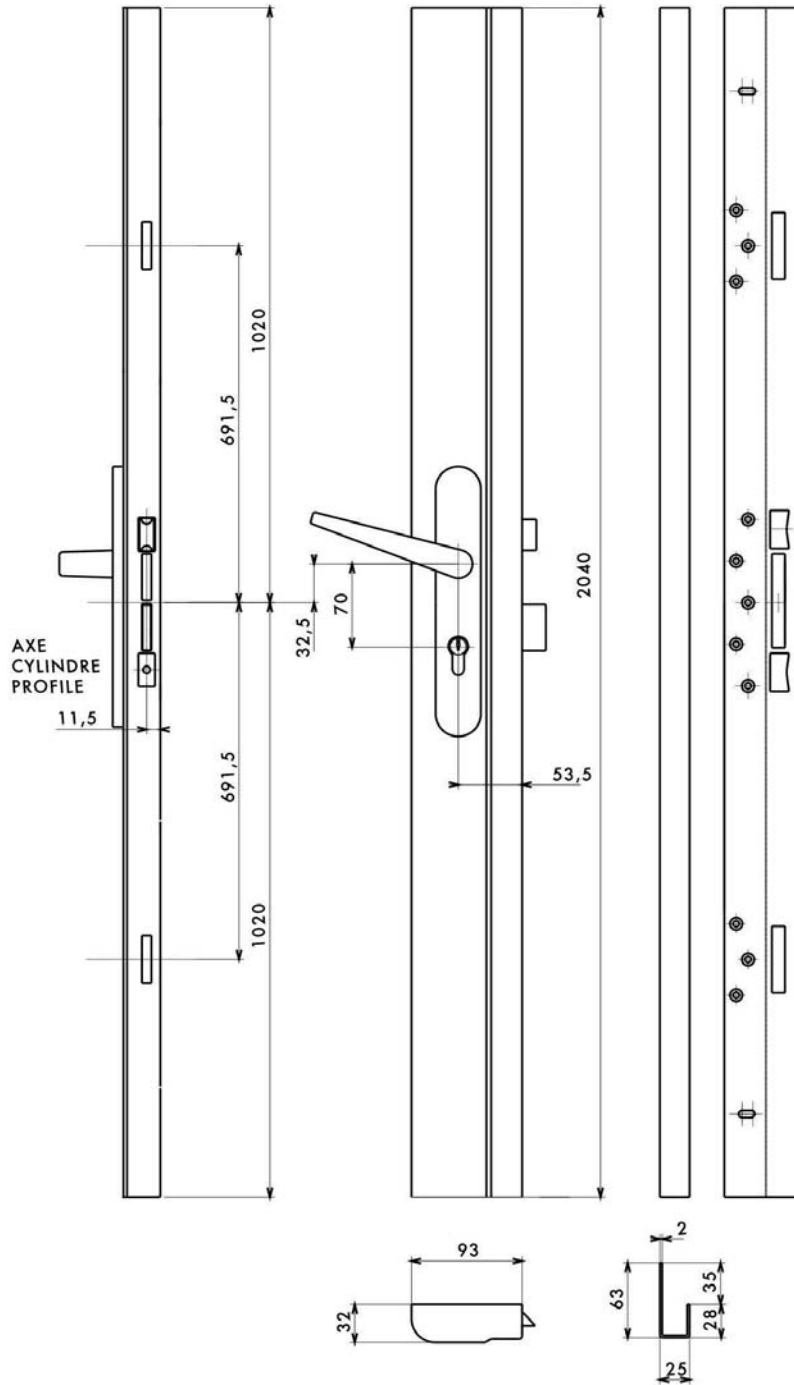



Description/Description/Descripción

Verrouillage par 3 points latéraux de condamnation. Boîtier principal acier 15/10 ème axe à 50 mm, entr'axe 70 mm - Carré 7 mm. 1/ 2 tour bipente laiton réversible sans démontage du coffre, équerre au 1/ 2 tour. Pênes dormant 2 tours acier zingué bichromaté. Boîtier asservis acier 15/10 ème avec pênes zingués rectangulaires. Gâche acier profilé 2 /10ème. ‹ Nous vous recommandons d'utiliser un cylindre profilé 30 x 65 mm pour porte d'épaisseur maxi 45 mm. Cylindre profilé ADRIATIC. Profil européen laiton finition nickel velours 30 x 65 mm pour porte de 45 mm. Mécanisme de 6 à 2 goupilles sur 5 rangées. Cylindre équipé de goupilles épaulées trempées anti-crochetage et protégé contre le perçage par 3 aiguilles trempées. Panneton anti arrachement. 4 clés plates laiton nickelé avec insert ABS et titre de propriété permettant la reproduction des clés exclusivement en usine. ‹ Pièce mobile anti-crochetage interne au cylindre interdisant toute reproduction hors usine.

Locking through 3 side button locking points. Main steel lock case 15/10th spindle at 50 mm, centerline 70 mm. Square 7 mm. Reversible brass double gradient 1/2 turn without removal of lock case, 1/2 turn lever. 2 turns dipped zinc-plated steel lock bolt. Steel locked lock case 15/10th with rectangular bichromate dipped zinc-plated lock bolts. Shaped steel strike plate 20/10th. Profile cylinder ADRIATIC European velvet nickel finish brass. profile cylinder, 30 x 65 mm for 45-mm door thickness. Mechanism with 6 to 22 pins on 5 rows. Cylinder equipped with anti-picking hardened shouldered pins and protected against drilling through 3 hardened needles. Anti-wrenching bit. 4 Nickel-plated brass reversible cylinder keys with ABS insert and property title allowing exclusive reproduction of keys in the factory.

Encerrojamiento por 3 puntos laterales de bloqueo. Caja principal de acero 15/10 eje a 50 mm, entrejeje 70 mm. Cuadrado 7 mm. 1/2 vuelta bipendiente de latón reversible sin desmontaje de la caja, escuadra a 1/2 vuelta. Pestillo de acero cincado 2 vueltas. Caja servocontrolada de acero 15/10 con pestillos cincados bicromatados rectangulares. Gachetas de acero perfilado 20/10. Cilindro perfilado ADRIATIC Perfil europeo de latón acabado níquel terciopelo, 30 x 65 mm para puerta de 45 mm. Mecanismo de 6 a 22 pasadores sobre 5 hileras. Cilindro equipado de pasadores reforzados templados anti-forzado y protegido contra la perforación por 3 agujas templadas. Paletón anti-desgarramiento. 4 llaves planas de latón niquelado con inserto ABS y título de propiedad que permite la reproducción de las llaves exclusivamente en fábrica.

Finition/Finish/Acabado

Epoxy marron ou blanc (Autres coloris sur demande)
Brown, white epoxy. Other complexions on inquiry
Epoxi marrón, blanco. Otros coloridos a petición

Version/Option/Versión

Pour porte hauteur maximum 2040mm. Pour porte hauteur maximum 2250mm. Autres dimensions, nous consulter.

Height 2,040 mm and 2,500 mm. Other dimensions to consult us. For covering door frame. Use Entrance door.
Altura 2040mm y 2500mm. Otras dimensiones, consultarnos. Para puerta que recubre el marco.
Utilización Puertas de entrada.



Serrure en applique 3 points / TRIBANDO

PROTECT



GARANTIE

Designation	Boite	Colis.	Prix	Sachet	Colis.	Prix	Brochable					Colis.	Prix
							France	Euro 1	Euro 2	Euro 3	Euro 4		
SERR. CP ADRIATIC réver. pour porte haut. 2040 mm maxi, marron 4 clés	00073162	1	-	-	-	-	-	-	-	-	-	-	-
SERR. CP ADRIATIC réver. pour porte haut. 2040 mm maxi, blanc 4 clés	00073163	1	-	-	-	-	-	-	-	-	-	-	-
BOIT. SERR. réver. avec gâche standard pour porte haut. 2250 mm maxi, marron	00073072	1	-	-	-	-	-	-	-	-	-	-	-
BOIT. SERR. réver. avec gâche standard pour porte haut 2250 mm maxi, blanc	00073073	1	-	-	-	-	-	-	-	-	-	-	-
BOIT. SERR. réver. avec gâche standard rasée pour porte haut 2250 mm maxi, marron	00078072	1	-	-	-	-	-	-	-	-	-	-	-
BOIT. SERR. réver. avec gâche standard rasée pour porte haut 2250 mm maxi, blanc	00078073 NS	1	-	-	-	-	-	-	-	-	-	-	-
BOIT. SERR. réver. avec gâche têteière 90 mm pour porte haut 2040 mm maxi, marron	00079072	1	-	-	-	-	-	-	-	-	-	-	-
BOIT. SERR. réver. avec gâche têteière 90 mm pour porte haut 2040 mm maxi, blanc	00079073	1	-	-	-	-	-	-	-	-	-	-	-
BOIT. SERR. réver. avec gâche pour porte à recouv. haut 2250 mm maxi, marron	00072072 NS	1	-	-	-	-	-	-	-	-	-	-	-
BOIT. SERR. réver. avec gâche pour porte à recouv. haut 2250 mm maxi, blanc	00072073	1	-	-	-	-	-	-	-	-	-	-	-
BOIT. SERR. réver. avec gâche rasée pour porte à recouv. haut. 2250 mm maxi, marron	00071072 NS	1	-	-	-	-	-	-	-	-	-	-	-
BOIT. SERR. réver. avec gâche rasée pour porte à recouv. haut. 2250 mm maxi, blanc	00071073 NS	1	-	-	-	-	-	-	-	-	-	-	-
GACHE standard SERR. réver. pour porte hauteur 2250 mm maxi, marron	00073077 NS	1	-	-	-	-	-	-	-	-	-	-	-

NS Non stocké/Non-stored/Producto no estocado - Sur stock Europe Zone 1 et Zone 2, nous consulter pour délai d'approvisionnement - E Epuement/Stock depletion/Agotamiento del stock

Serrure en applique 3 points / TRIBANDO

PROTECT



Designation	Boite	Colis.	Prix	Sachet	Colis.	Prix	Brochable					Colis.	Prix
							France	Euro 1	Euro 2	Euro 3	Euro 4		
GACHE standard SERR. réver. pour porte hauteur 2250 mm maxi, blanc	00073078 <small>NS</small>	1	-	-	-	-	-	-	-	-	-	-	-
GACHE standard rasée SERR réver. pour porte hauteur 2250 mm maxi, marron	00073083	1	-	-	-	-	-	-	-	-	-	-	-
GACHE standard rasée SERR réver. pour porte hauteur 2250 mm maxi, blanc	00073084	1	-	-	-	-	-	-	-	-	-	-	-
GACHE tête 90 mm SERR réver. pour porte hauteur 2040 mm maxi, marron	00073075	1	-	-	-	-	-	-	-	-	-	-	-
GACHE tête 90 mm SERR réver. pour porte hauteur 2040 mm maxi, blanc	00073076	1	-	-	-	-	-	-	-	-	-	-	-
GACHE SERR. réver. pour porte à recouv. haut. 2250 mm maxi, marron	00073081	1	-	-	-	-	-	-	-	-	-	-	-
GACHE SERR. réver. pour porte à recouv. hauteur 2250 mm maxi, blanc	00073082	1	-	-	-	-	-	-	-	-	-	-	-
GACHE rasée SERR réver. pour porte à recouv. haut. 2250 mm maxi, marron	00073079 <small>NS</small>	1	-	-	-	-	-	-	-	-	-	-	-
GACHE rasée SERR réver. pour porte à recouv. haut. 2250 mm maxi, blanc	00073080	1	-	-	-	-	-	-	-	-	-	-	-
GARNITURE extérieure CHANTILLY carré 7mm x125 mm serrure TRIBANDO marron	00014083	1	-	-	-	-	-	-	-	-	-	-	-
GARNITURE extérieure CHANTILLY carré 7mm x125 mm serrure TRIBANDO blanc	00014088	1	-	-	-	-	-	-	-	-	-	-	-
POIGNEE porte-palière CHANTILLY serrure TRIBANDO marron (1/2 ensemble)	00014084	1	-	-	-	-	-	-	-	-	-	-	-
POIGNEE porte-palière CHANTILLY serrure TRIBANDO blanc (1/2 ensemble)	00014089	1	-	-	-	-	-	-	-	-	-	-	-

NS Non stocké/Non-stored/Producto no estocado - ■ Sur stock Europe Zone 1 et Zone 2, nous consulter pour délai d'approvisionnement - E Epuement/Stock depletion/Agotamiento del stock





GARANTIE



X 4



Pour conserver la certification, les serrures doivent impérativement recevoir les sûretés ADRIATIC réf 00049356

Description/Description/Descripción

Verrouillage par 3 points latéraux de condamnation. Boîtier principal acier 15/10 ème axe à 50 mm, entr'axe 70 mm Carré 7 mm. 1/2 tour bipente laiton réversible sans démontage du coffre, équerre au 1/2 tour. Pène central 2 tours en acier trempé cémenté zingué. Pène dormant haut et bas 2 tours acier zingué. Boîtier asservis acier 15/10 ème avec pènes zingués rectangulaires. Gâche acier profilé 2 /10 ème. Module anti-arrachement en alliage moulé livré avec une plaque de protection en acier. Cylindre profilé ADRIATIC. Profil européen laiton finition nickel velours, 30 x 58 mm pour porte de 45 mm. Mécanisme de 6 à 22 goupilles sur 5 rangées. Cylindre équipé de goupilles épaulées trempées. anti-crochetage et protégé contre le perçage par 3 aiguilles trempées. Panneton anti arrachement. 4 clés plates laiton nickelé avec insert ABS et titre de propriété permettant la reproduction des clés exclusivement en usine. « Pièce mobile anti-crochetage interne au cylindre. interdisant toute reproduction hors usine.

Locking through 3 side button locking points. Main steel lock case 15/10th spindle at 50 mm, centerline 70 mm Square 7 mm. Reversible brass double gradient 1/2 turn without removal of lock case, 1/2 turn lever. 2 turns dipped zinc-plated steel lock central bolt up and down. 2 turns dipped zinc plated steel lock bolt. Steel locked lock case 15/10th with rectangular dipped. zinc-plated lock bolts. Shaped steel strike plate 20/10th. Antiarrachement module in molded alloy delivered with a plate of steel protection. Profile cylinder ADRIATIC European velvet nickel finish brass profile cylinder, 30 x 58 mm for 45-mm door. Mechanism with 6 to 22 pins on 5 rows. Cylinder equipped with anti-picking. hardened shouldered pins and protected against drilling through 3 hardened needles. Anti-wrenching bit. 4 Nickel-plated brass reversible cylinder keys with ABS insert and property title. allowing

exclusive reproduction of keys in the factory.

Encerrojamiento por 3 puntos laterales de bloqueo. Caja principal de acero 15/10 eje a 50 mm, entreaje 70 mm. Cuadrado 7 mm. 1/2 vuelta bipendiente de latón. reversible sin desmontaje de la caja,. escuadra a 1/2 vuelta. Pestillo central de acero cincado 2 vueltas. Pestillo alto y bajo de acero cincado 2 vueltas. Caja servocontrolada de acero 15/10 con pestillos. cincados rectangulares. Gachetas de acero perfilado 20/10. Módulo anti-desgarramiento en mezcla hecha en molde entregada con una placa de protección de acero. Cilindro perfilado ADRIATIC Perfil europeo de latón acabado níquel terciopelo, 30 x 58 mm para puerta de 45 mm. Mecanismo de 6 a 22 pasadores sobre 5 hileras. Cilindro equipado de pasadores reforzados templados. anti-forzado y protegido contra la perforación por 3 agujas templadas. Paletón anti-desgarramiento. 4 llaves planas de latón níquelado con inserto ABS y título de propiedad que permite la reproducción de las llaves exclusivamente en fábrica.

Finition/Finish/Acabado

Epoxy marron ou blanc (Autres coloris sur demande) Brown, white epoxy. Other complexions on inquiry. Epoxi marrón, blanco. Otros coloridos a petición.

Version/Option/Versión

Pour porte hauteur maximum 2040mm. Pour porte hauteur maximum 2250mm. Autres dimensions, nous consulter. Gâches pour porte à recouvrement. Height 2,040 mm and 2,500 mm. Other dimensions to consult us. For covering door frame. Altura 2040 mm y 2500 mm. Otras dimensiones, consultarnos. Para puerta que recubre el marco

Serrure applique horizontale / BEC DE CANE

ECO



GARANTIE

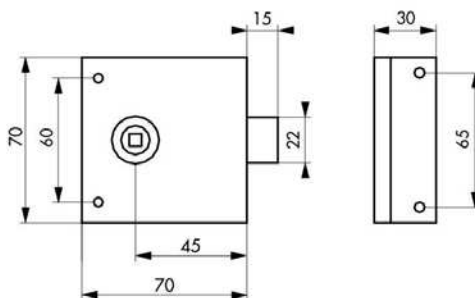

Description/Description/Descripción

Coffre et gâche acier cambré. Pêne demi-tour alliage.
Réversible, pour pose à droite et à gauche. Carré 6 mm.
Cambered steel case and striker. Alloy latch bolt.
Reversible for fitting right and left hand. Square 6 mm.
Caja y cerradero de acero curvado. Pestillo de media
vuelta de aleación. Reversible, para montaje a la derecha
y a la izquierda. Cuadrado 6 mm.

Finition/Finish/Acabado

Epoxy noir granité
Granited black epoxy
Epoxi negro granitado

Designation	Boite	Colis.	Prix	Sachet	Colis.	Prix	Brochable					Colis.	Prix
							France	Euro 1	Euro 2	Euro 3	Euro 4		
SERRURE bec de cane 70 x 70 mm	00000177	1	-	-	-	-	00300177	-	-	-	-	5	-
SERRURE bec de cane 85 x 76 mm	00000108	1	-	-	-	-	00300108	-	-	-	-	5	-
SERR. bec de cane 85 x 76 mm ? 8 mm	00009108	1	-	-	-	-	-	-	-	-	-	-	-
SERRURE bec de cane 95 x 76 mm	00000109	1	-	00900109	5	-	00300109	-	-	-	-	-	-
SERRURE bec de cane 110 x 80 mm	00000110	1	-	00900110	5	-	00300110	-	-	-	-	5	-

⚠ Non stocké/Non-stored/Producto no estocado - ☑ Sur stock Europe Zone 1 et Zone 2, nous consulter pour délai d'approvisionnement - ☒ Epuisement/Stock depletion/Agotamiento del stock

Serrure applique horizontale / PÊNE DORMANT 1/2 TOUR ECO



GARANTIE



X 2

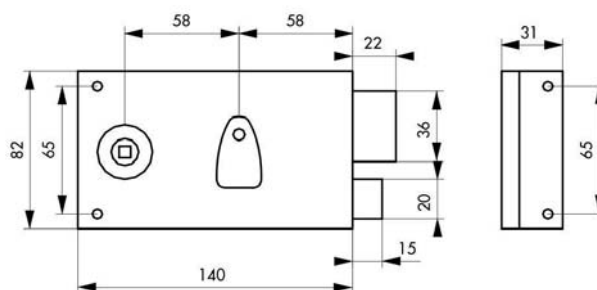

Description/Description/Descripción

Coffre et gâche acier cambré. Pêne et demi-tour acier. Canon acier long. 40 mm. Mécanisme à 2 tours. Pêne 1/2 tour réversible pour porte ouvrant à l'extérieur. Carré 6 mm. 2 clés nickelées (1 clé zinguée sous conditionnement bac) 6 variées. Entrée de clé et de fouillot acier.

Cambered steel case and striker. Steel bolt and latch. 40 mm steel bush. Double latch mechanism. Reversible latch bolt for outside opening door. Square 6 mm. 2 nickel plated keys. (1 zinc plated key on polybag packing). 6 key differs. Steel key hole and follower plate.

Caja y cerradero de acero curvado. Pestillo y media vuelta de acero. Cañón de acero, long. 40 mm. Mecanismo de 2 vueltas. Pestillo de media vuelta reversible para puerta con apertura hacia el exterior. Cuadrado 6 mm. 2 llaves niqueladas. (1 llave cincado preparación en caja). 6 perfiles de llave. Entrada de llave y de nuez de acero.

Finition/Finish/Acabado

Epoxy noir granité
Granited black epoxy

Version/Option/Versión

Droite et gauche
Right and left hand
Derecha e izquierda



Designation	Boite	Colis.	Prix	Sachet	Colis.	Prix	Brochable				Colis.	Prix	
							France	Euro 1	Euro 2	Euro 3			Euro 4
SERR. PDT 1/2 tour 140 x 82 mm droite	00000111	1	-	00900111	10	-	00500111	-	-	-	-	5	-
SERR. PDT 1/2 tour 140 x 82 mm gauche	00000121	1	-	00900121	10	-	00500121	-	-	-	-	5	-

⊗ Non stocké/Non-stored/Producto no estocado - ⊗ Sur stock Europe Zone 1 et Zone 2, nous consulter pour délai d'approvisionnement - ⊗ Epuisement/Stock depletion/Agotamiento del stock

Serrure applique verticale / PÊNE DORMANT 1/2 TOUR

ECO



GARANTIE



X 2

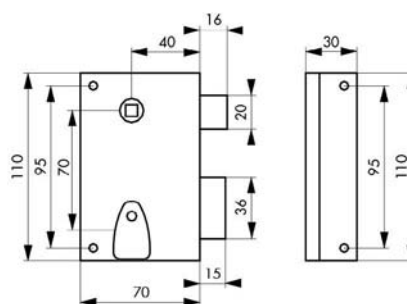

Description/Description/Descripción

Coffre et gâche acier cambré. Pêne acier. Demi-tour acier. Canon acier long. 35 mm. Mécanisme à 1 tour. Pêne 1/2 tour réversible pour porte ouvrant à l'extérieur. Carré 7 mm. 2 clés nickelées. (1 clé zinguée sous conditionnement bac). 6 variures. Entrée de clé et de fouillot acier.

Cambered steel case. and striker. Steel bolt - Steel latch. Steel bush 35 mm length. Single latch mechanism. Reversible latch bolt for outside opening door. Square 7 mm. 2 nickel plated keys. (1 zinc plated key on polybag packing). 6 key differs. Steel key hole and follower plate. Caja y cerradero de acero curvado. Pestillo de acero. Media vuelta de acero. Cañón de acero, long. 35 mm. Mecanismo de 1 vuelta. Pestillo media vuelta reversible para puerta con apertura hacia el exterior. Cuadrado 7 mm. 2 llaves níqueladas. (1 llave cincado preparación en caja). 6 perfiles de llave. Entrada de la llave y de la nuez de acero.

Finition/Finish/Acabado

Epoxy noir granité
Granited black epoxy
 Epoxi negro granitado

Version/Option/Versión

Avec tête rasée sur coffre et gâche pour portail. Droite et gauche.

With forend shaved on case and striker for gate. Right and left hand.

Con cabeza enrasada en caja y cerradero para portal. Derecha e izquierda.

Designation	Boite	Colis.	Prix	Sachet	Colis.	Prix	Brochable					Colis.	Prix
							France	Euro 1	Euro 2	Euro 3	Euro 4		
SERR. 70 x 110 mm tête rasée affleurante droite	00001131	1	-	-	-	-	-	-	-	-	-	-	-
SERR. 70 x 110 mm tête rasée affleurante gauche	00001141	1	-	-	-	-	-	-	-	-	-	-	-
SERR. 70 x 110 mm droite	00000131	1	-	00900131	10	-	00300131	-	-	-	-	5	-
SERR. 70 x 110 mm gauche	00000141	1	-	00900141	10	-	00300141	-	-	-	-	5	-

⚠ Non stocké/Non-stored/Producto no estocado - 📦 Sur stock Europe Zone 1 et Zone 2, nous consulter pour délai d'approvisionnement - 📦 Epusement/Stock depletion/Agotamiento del stock

Serrure applique verticale / PÊNE DORMANT 1/2 TOUR «ALSACE» ECO



GARANTIE



X 2

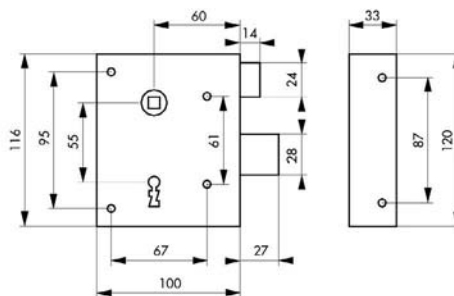

Description/Description/Descripción

Coffre et gâche acier cambré. Pêne et demi-tour acier.
Mécanisme à 2 tours. Carré 8 mm. 2 clés nickelées.
6 variures.

*Cambered steel case and striker. Steel bolt and latch.
Double latching mechanism. Square 8 mm. 2 nickel plated
keys.*

Caja y cerradero de acero curvado. Pestillo y media
vuelta de acero. Mecanismo de 2 vueltas. Cuadrado 8
mm. 2 llaves niqueladas. 6 perfiles de llave.

Finition/Finish/Acabado

Zingué
Zinc coated
Cincado

Version/Option/Versión

Droite et gauche. Tirant. Poussant.
Right and left hand.
Derecha e izquierda



Designation	Boite	Colis.	Prix	Sachet	Colis.	Prix	Brochable					Colis.	Prix
							France	Euro 1	Euro 2	Euro 3	Euro 4		
SERRURE PDT 1/2 tour axe 60 "tirant" 100 x 120 mm droite	00010511	1	-	00910511	10	-	00310511	00393231 NS	00392231 NS	00394231	-	5	-
SERRURE PDT 1/2 tour axe 60 "tirant" 100 x 120 mm gauche	00010521	1	-	00910521	10	-	00310521	00393232 NS	00392232 NS	00394232	-	5	-
SERRURE PDT 1/2 tour axe 60 "poussant" 100 x 120 mm droite	00011511	1	-	00911511	10	-	00311511	00393233 NS	00392233 NS	00394233	-	5	-
SERRURE PDT 1/2 tour axe 60 "poussant" 100 x 120mm gauche	00011521	1	-	00911521	10	-	00311521	00393234 NS	00392234 NS	00394234	-	5	-

NS Non stocké/Non-stored/Producto no estocado - Sur stock Europe Zone 1 et Zone 2, nous consulter pour délai d'approvisionnement - E Epuisement/Stock depletion/Agotamiento del stock

Serrure applique horizontale / CYLINDRE RIM PROTECT



GARANTIE



X 3

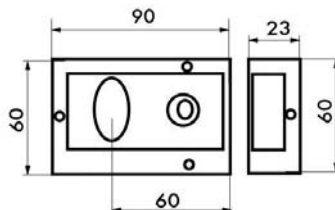

Description/Description/Descripción

Coffre et gâche acier cambré. Pêne 1/2 tour acier.
Réversible. Condamnation et décondamnation intérieure
par bouton. 3 clés.

*Cambered steel case and striker. Steel bolt. Reversible.
Inside locking and unlocking by knob. 3 keys.*

Caja y cerradero de acero curvado. Pestillo media vuelta
de acero. Reversible. Condenación y descondenación
interior por botón. 3 llaves.

Finition/Finish/Acabado

Doré
Gold
Dorado

Designation	Boite	Colis.	Prix	Sachet	Colis.	Prix	Brochable					Colis.	Prix
							France	Euro 1	Euro 2	Euro 3	Euro 4		
SERRURE 90 x 60 mm 3 clés	-	-	-	-	-	-	-	00593246 NS	00592246 NS	-	-	5	-

Serrure applique horizontale / CYLINDRE RIM PROTECT



GARANTIE



X 3

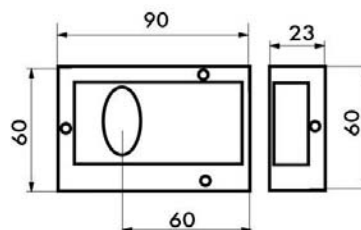

Description/Description/Descripción

Coffre et gâche acier cambré. Pêne dormant acier.
Réversible. 3 clés.

*Cambered steel case and striker. Steel dead bolt.
Reversible. 3 keys.*

Caja y cerradero de acero curvado. Pestillo durmiente de
acero. Reversible. 3 llaves.

Finition/Finish/Acabado

Doré
Gold
Dorado

Designation	Boite	Colis.	Prix	Sachet	Colis.	Prix	Brochable					Colis.	Prix
							France	Euro 1	Euro 2	Euro 3	Euro 4		
SERRURE 90 x 60 mm 3 clés	-	-	-	-	-	-	-	00593247 NS	00592247 NS	-	-	5	-

Serrure tubulaires / BEC DE CANE - A CONDAMNATION

ECO



GARANTIE

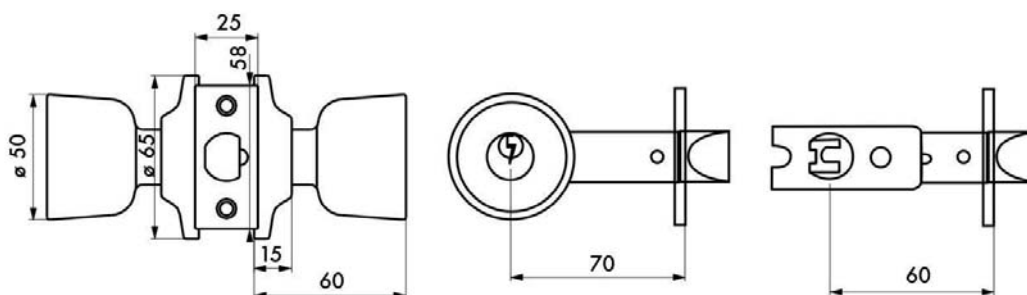

Description/Description/Descripción

Pommeau extérieur en acier embouti. Pommeau intérieur en acier embouti avec bouton de condamnation. Pêne 1/2 tour réversible avec tête rectangulaire. Gâche plate. Axe réglable 60/70mm. Dispositif d'urgence qui permet de décondamner la serrure à l'aide d'un clou.

Stamped steel turning knobs. Reversible bolt with rectangular forend. Flat striker. Backset 60/70mm.

Pomos libres por ambos lados de acero embutido. Pestillo media vuelta reversible con cabeza rectangular. Cerradero plano. Eje 60/70mm.

Finition/Finish/Acabado

Chromé mat. Doré.

Dull chrome plated. Gold plated

Cromado mate. Dorado

Versión/Option/Versión

Boîtier axe à 60 mm

60 mm backset latch bolt

Caja eje a 60 mm

Utilisation/Use/Utilización

Porte intérieure ép. 35 à 45 mm

Inside door 35 to 45 mm thickness

Puertas interiores de 35 a 45 mm de espesor



Designation	Boite	Colis.	Prix	Sachet	Colis.	Prix	Brochable				Colis.	Prix	
							France	Euro 1	Euro 2	Euro 3			Euro 4
SERRURE bec de cane chromé mat - axe réglable 60/70mm	-	-	-	-	-	-	00500555	-	00592425	-	-	5	-
SERRURE bec de cane doré - axe réglable 60/70mm	-	-	-	-	-	-	00501555	-	00592426	-	-	5	-
SERRURE bec de cane à condamnation chromé mat - axe réglable 60/70mm	-	-	-	-	-	-	00500553	-	-	-	-	5	-
SERRURE bec de cane à condamnation doré - axe réglable 60/70mm	-	-	-	-	-	-	00501553	-	-	-	-	5	-

Non stocké/Non-stored/Producto no estocado - Sur stock Europe Zone 1 et Zone 2, nous consulter pour délai d'approvisionnement - Epuisement/Stock depletion/Agotamiento del stock

Serrure porte en verre / POUR CYLINDRE PROFILE AVEC BEQUILLE PROTECT



GARANTIE

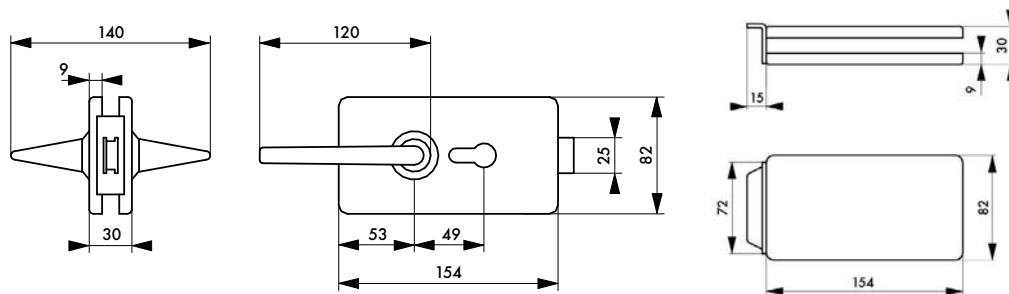

Description/Description/Descripción

Coffre laiton embouti avec double béquille. Réversible sans retournement du 1/2 tour. Rappel du 1/2 tour par la clé. Adaptable sur encoche 64 A. Gâche plate. A utiliser avec un cylindre 30 x 30 mm.

Brass stamped case with double handle. Reversible without changing the latch. Drawback of the latch by key. For doors with a standard slot 64 A. Flat striker.

Caja de latón embutido con doble brazo. Reversible sin inversión de la media vuelta. Reposición de la media vuelta con la llave. Adaptable en ranura 64 A. Cerradero plano.

Finition/Finish/Acabado

Chromé, autres finitions sur demande

Chrome plated, other finishes on request

Cromado, otros acabados por encargo

Utilisation/Use/Utilización

Porte en verre de 8 à 10 mm d'épaisseur

For glass doors 8 to 10 mm thickness

Puertas de vidrio de 8 a 10 mm de espesor

Encoche numéro 64 A
pour réf 009300 - 003309

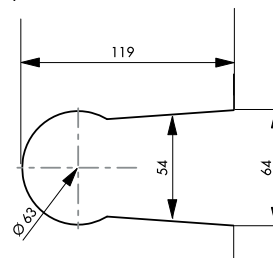

Designation	Boite	Colis.	Prix	Sachet	Colis.	Prix	Brochable					Colis.	Prix
							France	Euro 1	Euro 2	Euro 3	Euro 4		
BOITIER SERRURE DE MILIEU réversible à cylindre avec béquille	00009300	1	-	-	-	-	00509300	-	-	-	-	1	-
GACHE A REPETITION pour serrure de milieu chromée	-	-	-	-	-	-	00503309	-	-	-	-	1	-

⚠ Non stocké/Non-stored/Producto no estocado - 📦 Sur stock Europe Zone 1 et Zone 2, nous consulter pour délai d'approvisionnement - 📦 Epuisement/Stock depletion/Agotamiento del stock

Serrure porte en verre / POUR CYLINDRE

PROTECT



GARANTIE



Encoche numéro 61 pour réf 008358

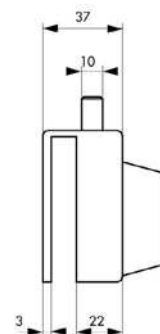
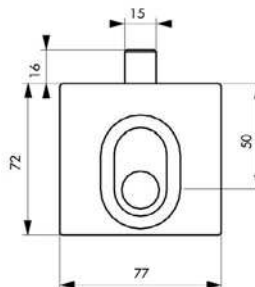
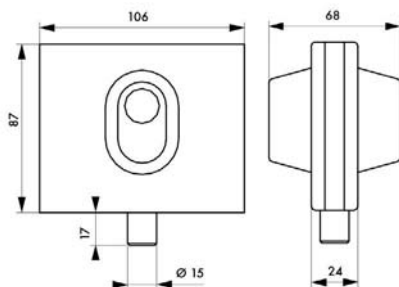
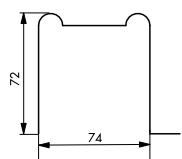

Description/Description/Descripción

Coffre laiton embouti. Pêne monobloc avec insert cémenté. Se pose sur le chant de la porte. Réf : 008435 ne nécessite aucune encoche dans la porte. Fixation par 2 vis de serrage. Joint. Gâche plate. Réf 008435 à utiliser avec un cylindre 30 x 10 mm. Réf 008358 à utiliser avec un cylindre 30 x 30 mm

Brass stamped case. Compact bolt with hardened inserted part. To be fixed on the edge of the door. Without any slot in the door. Fixing with 2 screws. Joint. Flat striker.

Caja de latón embutido. Pestillo monobloque con inserción cementada. Se monta en el canto de la puerta. No requiere ninguna ranura en la puerta. Fijación mediante 2 tornillos de apriete. Junta. Cerradero plano.

Finition/Finish/Acabado

Chromé, autres finitions sur demande
Chrome plated, other finishes on request
Cromado, otros acabados por encargo

Utilisation/Use/Utilización

Porte en verre de 8 à 10 mm d'épaisseur
For glass doors 8 to 10 mm thickness
Puertas de vidrio de 8 a 10 mm de espesor



Designation	Boite	Colis.	Prix	Sachet	Colis.	Prix	Brochable					Colis.	Prix
							France	Euro 1	Euro 2	Euro 3	Euro 4		
BOITIER SERRURE BASSE à cylindre	00008358	1	-	-	-	-	00308358	-	-	-	-	1	-
BOITIER VERROU CAVALIER à cylindre	00008435	1	-	-	-	-	00308435	-	-	-	-	1	-

Non stocké/Non-stored/Producto no estocado - Sur stock Europe Zone 1 et Zone 2, nous consulter pour délai d'approvisionnement - Epuement/Stock depletion/Agotamiento del stock

Serrure applique horizontale / PÊNE DORMANT

ECO



GARANTIE



X 1



	85x76	95x76	110x80	140x80	160x80
A	85	95	110	140	160
B	67	74	89	120	140
C	50	60	60	80	105
D	76	76	80	80	80

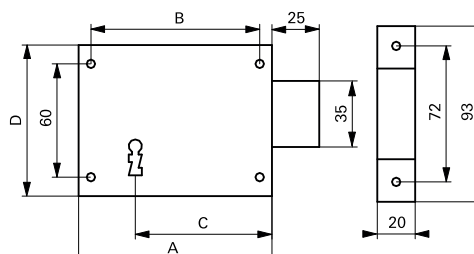

Description/Description/Descripción

Coffre en acier cambré. Gâche à pattes acier cambré.
Pêne alliage. Canon acier long. 35 mm. 1 clé polie. 6
Cambered steel case. Cambered steel striker. Alloy bolt.
35 mm steel bush. 1 key. 6 key differs
Caja de acero curvado. Cerradero de patillas de acero
curvado. Pestillo de aleación. Cañón de acero, long. 351
llave pulida. 6 perfiles de llave.

Finition/Finish/Acabado

Epoxy noir granité
Granited black epoxy
Epoxi negro granitado

Version/Option/Versión

Droite et gauche
Right and left hand
Derecha e izquierda

Designation	Boite	Colis.	Prix	Sachet	Colis.	Prix	Brochable					Colis.	Prix
							France	Euro 1	Euro 2	Euro 3	Euro 4		
SERR. pêne dormant 85 x 76 mm drte	00003117	1	-	-	-	-	00303117	00393980 NS	00392980 NS	00394980	-	5	-
SERR. pêne dormant 85 x 76 mm gauche	00003127	1	-	-	-	-	00303127	00393981 NS	00392981 NS	00394981	-	5	-
SERR. pêne dormant 95 x 76 mm droite	00002117	1	-	00902117	5	-	00302117	00393982 NS	00392982 NS	00394982	-	5	-
SERR. pêne dormant 95 x 76 mm gauche	00002127	1	-	00902127	5	-	00302127	00393983 NS	00392983 NS	00394983	-	5	-
SERR. pêne dormant 110 x 80 mm droite	00001117	1	-	00901117	5	-	00301117	00393984 NS	00392984 NS	00394984	-	5	-
SERR. pêne dormant 110 x 80 mm gauche	00001127	1	-	00901127	5	-	00301127	00393985 NS	00392985 NS	00394985	-	5	-
SERR. pêne dormant 140 x 80 mm droite	00000117	1	-	00900117	5	-	00300117	00393986 NS	00392986 NS	00394986	-	5	-
SERR. pêne dormant 140 x 80 mm gauche	00000127	1	-	00900127	5	-	00300127	00393987 NS	00392987 NS	00394987	-	5	-
SERR. pêne dormant 160 x 80 mm droite	00013901	1	-	-	-	-	00513901	00393988 NS	00392988 NS	00394988	-	5	-
SERR. pêne dormant 160 x 80 mm gauche	00013902	1	-	-	-	-	00513902	00393989 NS	00392989 NS	00394989	-	5	-

NS Non stocké/Non-stored/Producto no estocado - S Sur stock Europe Zone 1 et Zone 2, nous consulter pour délai d'approvisionnement - E Epuisement/Stock depletion/Agotamiento del stock

Serrure applique horizontale / PÈNE DORMANT

ECO



GARANTIE



X 2



	85x76	95x76	110x80	140x80	160x80
A	85	95	110	140	160
B	67	74	89	120	140
C	50	60	60	80	105
D	76	76	80	80	80

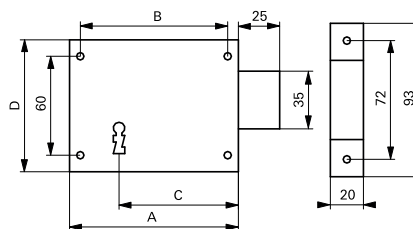

Description/Description/Descripción

Coffre en acier cambré. Gâche à pattes acier cambré.
Pêne alliage. Canon acier long. 35 mm. 2 clés polie. 6
Cambered steel case. Cambered steel striker. Alloy bolt.
35 mm steel bush. 1 keys. 6 key differs
Caja de acero curvado. Cerradero de patillas de acero
curvado. Pestillo de aleación. Cañón de acero, long. 352
llaves pulida. 6 perfiles de llave.

Finition/Finish/Acabado

Epoxy noir granité
Granited black epoxy
Epoxi negro granitado
Version/Option/Versión
Droite et gauche
Right and left hand
Derecha e izquierda

Designation	Boite	Colis.	Prix	Sachet	Colis.	Prix	Brochable					Colis.	Prix
							France	Euro 1	Euro 2	Euro 3	Euro 4		
SERR. pêne dormant 85 x 76 mm droite	00093917	1	-	-	-	-	-	-	-	-	-	-	-
SERR. pêne dormant 85 x 76 mm gauche	00093927	1	-	-	-	-	-	-	-	-	-	-	-
SERR. pêne dormant 95 x 76 mm droite	00092117	1	-	-	-	-	00392117	-	-	-	-	5	-
SERR. pêne dormant 95 x 76 mm gauche	00092127	1	-	-	-	-	00392127	-	-	-	-	5	-
SERR. pêne dormant 110 x 80 mm droite	00091117	1	-	991117	5	-	00391117	-	-	-	-	5	-
SERR. pêne dormant 110 x 80 mm gauche	00091127	1	-	991127	5	-	00391127	-	-	-	-	5	-
SERR. pêne dormant 140 x 80 mm droite	00090117	1	-	-	-	-	00390117	-	-	-	-	5	-
SERR. pêne dormant 140 x 80 mm gauche	00090127	1	-	-	-	-	00390127	-	-	-	-	5	-

Non stocké/Non-stored/Producto no estocado - Sur stock Europe Zone 1 et Zone 2, nous consulter pour délai d'approvisionnement - Epuement/Stock depletion/Agotamiento del stock

Serrure applique horizontale / 6 GORGES PÊNE DORMANT SEUL ECO



GARANTIE



X 2

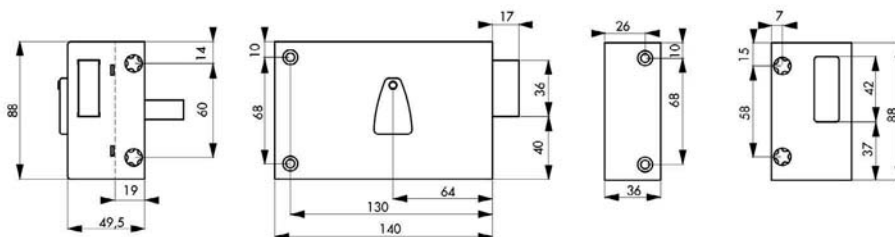

Description/Description/Descripción

Coffre et gâche acier cambré. Pêne soudé acier zingué. Canon en alliage long. 45 mm, mécanisme 6 gorges à 2 tours. 2 clés nickelées. 2 variures. Entrée de clé acier zinguée.

Cambered steel case and striker. Welded zinc-plated steel bolt. Alloy bush 45 mm length, 6 lever mechanism double latch. 2 nickel plated keys. 2 variures. Zinc coated steel key hole.

Caja y cerradero de acero curvado. Pestillo de acero cincado soldada. Cañón de aleación, long. 45 mm, mecanismo de 6 canalillos 2 vueltas. 2 llaves niqueladas. 2 perfiles de llave. Entrada de la llave de acero cincado.

Finition/Finish/Acabado

Epoxy noir

Black epoxy

Epoxi negro

Version/Option/Versión

Droite et gauche.

Right and left hand.

Derecha e izquierda.

Designation	Boite	Colis.	Prix	Sachet	Colis.	Prix	Brochable					Colis.	Prix
							France	Euro 1	Euro 2	Euro 3	Euro 4		
SERRURE 6 gorges 140x88 mm droite	00086114	1	-	-	-	-	-	-	-	-	-	-	-
SERRURE 6 gorges 140x88 mm gauche	00086124	1	-	-	-	-	-	-	-	-	-	-	-

⚠ Non stocké/Non-stored/Producto no estocado - 📦 Sur stock Europe Zone 1 et Zone 2, nous consulter pour délai d'approvisionnement - 📦 Epuisement/Stock depletion/Agotamiento del stock

Serrure applique verticale / 6 GORGES PÊNE DORMANT SEUL ECO



GARANTIE



X 2

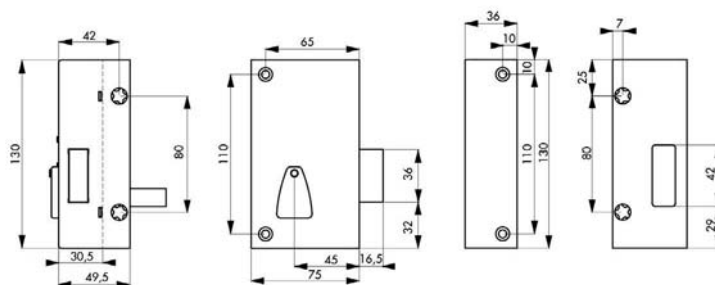

Description/Description/Descripción

Coffre et gâche acier cambré. Pêne soudé acier zingué. Canon en alliage long. 45 mm, mécanisme 6 gorges à 2 tours. 2 clés nickelées. 2 variures. Entrée de clé acier zinguée.

Cambered steel case and striker. Welded zinc-plated steel bolt. Alloy bush 45 mm length, 6 lever mechanism double latch. 2 nickel plated keys. 2 variures. Zinc coated steel key hole.

Caja y cerradero de acero curvado. Pestillo de acero cincado soldada. Cañón de aleación, long. 45 mm, mecanismo de 6 canalillos 2 vueltas. 2 llaves niqueladas. 2 perfiles de llave. Entrada de la llave de acero cincado.

Finition/Finish/Acabado

Epoxy noir

Black epoxy

Epoxi negro

Version/Option/Versión

Droite et gauche.

Right and left hand.

Derecha e izquierda.



Designation	Boite	Colis.	Prix	Sachet	Colis.	Prix	Brochable					Colis.	Prix
							France	Euro 1	Euro 2	Euro 3	Euro 4		
SERRURE 75 x 130 mm droite	00086117	1	-	-	-	-	-	-	-	-	-	-	-
SERRURE 75 x 130 mm gauche	00086127	1	-	-	-	-	-	-	-	-	-	-	-

Non stocké/Non-stored/Producto no estocado - Sur stock Europe Zone 1 et Zone 2, nous consulter pour délai d'approvisionnement - Epuement/Stock depletion/Agotamiento del stock

Serrure applique horizontale / POUR CP PÊNE DORMANT SEUL ECO



GARANTIE

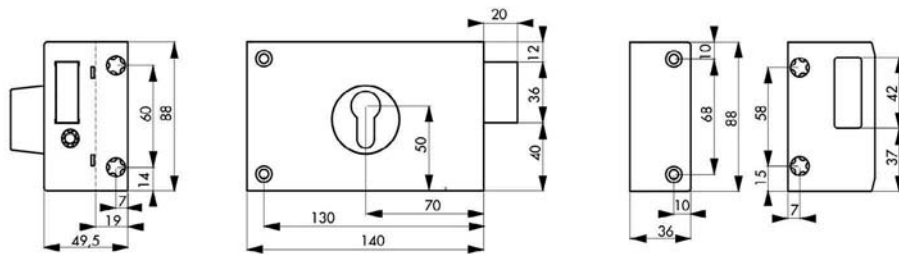

Description/Description/Descripción

Coffre et gâche acier cambré. Pêne soudé acier zingué.
Mécanisme à 2 tours.

Cambered steel case and striker. Welded zinc-plated steel bolt. Two deadbolt throw.

Caja y cerradero de acero curvado. Pestillo de acero cincado soldada. Mecanismo de 2 vueltas.

Finition/Finish/Acabado

Epoxy noir
Black epoxy
Black epoxy

Version/Option/Versión

Droite et gauche.
Right and left hand.
Derecha e izquierda.

Designation	Boite	Colis.	Prix	Sachet	Colis.	Prix	Brochable					Colis.	Prix
							France	Euro 1	Euro 2	Euro 3	Euro 4		
BOITIER CP 140 x 88 mm droite	00086112	1	-	-	-	-	-	-	-	-	-	-	-
BOITIER CP 140 x 88 mm gauche	00086122	1	-	-	-	-	-	-	-	-	-	-	-

⚠ Non stocké/Non-stored/Producto no estocado - 📦 Sur stock Europe Zone 1 et Zone 2, nous consulter pour délai d'approvisionnement - 📦 Epuisement/Stock depletion/Agotamiento del stock

Serrure applique verticale / POUR CP PÊNE DORMANT SEUL ECO



GARANTIE

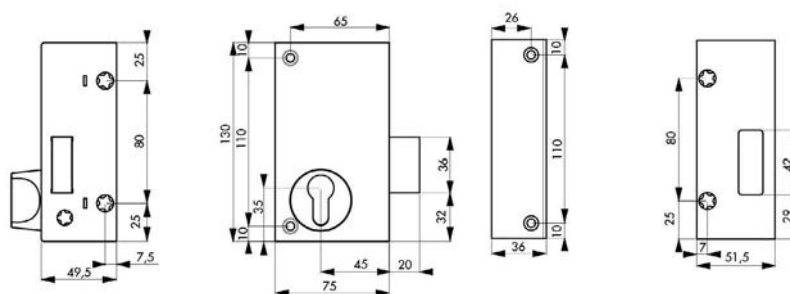

Description/Description/Descripción

Coffre et gâche acier cambré. Pêne soudé acier zingué.
Mécanisme à 2 tours.

Cambered steel case and striker. Welded zinc-plated steel bolt. Two deadbolt throw.

Caja y cerradero de acero curvado. Pestillo de acero cincado soldada. Mecanismo de 2 vueltas.

Finition/Finish/Acabado

Epoxy noir
Black epoxy
Epoxi negro

Version/Option/Versión

Droite et gauche.
Right and left hand.

Derecha e izquierda.



Designation	Boite	Colis.	Prix	Sachet	Colis.	Prix	Brochable					Colis.	Prix
							France	Euro 1	Euro 2	Euro 3	Euro 4		
BOITIER CP 75 x 130 mm droite	00086113	1	-	-	-	-	-	-	-	-	-	-	-
BOITIER CP 75 x 130 mm gauche	00086123	1	-	-	-	-	-	-	-	-	-	-	-

☒ Non stocké/Non-stored/Producto no estocado - ☑ Sur stock Europe Zone 1 et Zone 2, nous consulter pour délai d'approvisionnement - ☒ Epuisement/Stock depletion/Agotamiento del stock

Serrure de garage / A CYLINDRE ET BOUTON POUSSOIR PROTECT



GARANTIE



X 3

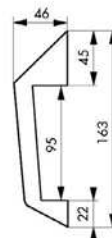
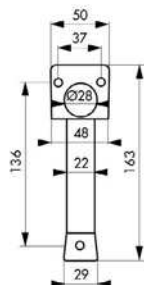
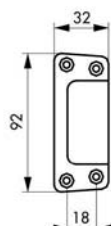
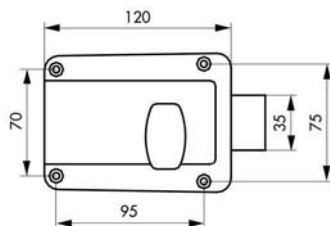
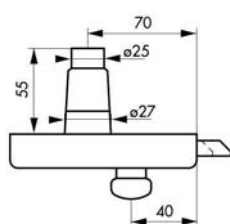

Description/Description/Descripción

Coffre et gâche acier embouté. Cylindre à goupilles Ø 2 pour porte de 30 mm maxi. Cylindre poussoir pour ouverture de la porte. Condamnation intérieure par bouton. Poignée extérieure PVC. 3 clés nickelées.
Stamped steel case and striker. Pushing cylinder Ø 25 for 30 mm thickness door. Inside locking by knob. PVC outside handle. 3 nickel plated keys.

Caja y cerradero de acero embutido. Cilindro de pasadores Ø 25 para puerta de 30 mm como máximo. Cilindro empujador para apertura de la puerta. Condenación interior mediante botón. Tirador exterior de PVC. 3 llaves niqueladas.

Finition/Finish/Acabado

Laqué gris
Grey lacquered
Lacado gris

Versión/Option/Versión

Droite et gauche
Right and left hand
Derecha e izquierda

Utilisation/Use/Utilización

Porte de garage à déplacement latéral à battant
Lateral sliding swing garage door
Puerta de garaje con desplazamiento lateral de batiente

Designation	Boite	Colis.	Prix	Sachet	Colis.	Prix	Brochable					Colis.	Prix
							France	Euro 1	Euro 2	Euro 3	Euro 4		
SERRURE DE SURETE à cyl. et bouton poussoir 120 x 90 droite avec poignée	00000017	1	-	-	-	-	00500017	-	-	-	-	2	-
SERRURE DE SURETE à cyl. et bouton poussoir 120 x 90 gauche avec poignée	00000027	1	-	-	-	-	00500027	-	-	-	-	2	-
POIGNEE seule	00009127	1	-	00909127	10	-	00200127	-	-	-	-	10	-

⚠ Non stocké/Non-stored/Producto no estocado - 📦 Sur stock Europe Zone 1 et Zone 2, nous consulter pour délai d'approvisionnement - 📦 Epuisement/Stock depletion/Agotamiento del stock

Serrure de garage / A CYLINDRE ET BOUTON, A TIRAGE PROTECT



GARANTIE



X 3

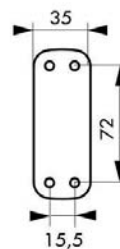
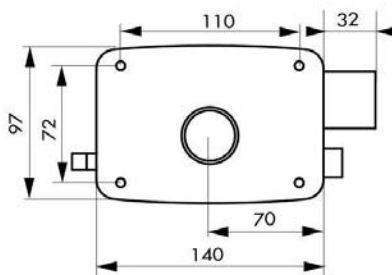
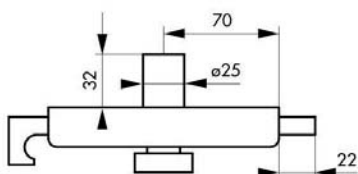

Description/Description/Descripción

Coffre et gâche acier embouti. Cylindre de sûreté à goupilles Ø 2 long. 32 mm. Bouton de condamnation intérieure et tirage. Pêne et demi-tour laiton. Rappel du demi-tour par la clé. 3 clés laiton nickelé

Stamped steel case and striker. Safety cylinder Ø 25, 32 mm length. Inside locking knob and drawback. Brass bolt and latch. Drawback of the latch by the key. 3 brass nickel plated keys.

Caja y cerradero de acero embutido. Cilindro de seguridad con pasadores Ø 25 long. 32 mm. Botón de condenación interior y tirador. Pestillo y media vuelta de latón. Reposición de la media vuelta con la llave. 3 llaves de latón niqueladas.

Finition/Finish/Acabado

Noir.

Black.

Negro.

Version/Option/Versión

Droite et gauche

Right and left hand

Derecha e izquierda

Utilisation/Use/Utilización

Porte de garage à battant

Swing garage door

Puertas de garaje de batientes



Designation	Boite	Colis.	Prix	Sachet	Colis.	Prix	Brochable				Colis.	Prix	
							France	Euro 1	Euro 2	Euro 3			Euro 4
SERR. DE SURETE 140 x 90 mm droite	00000047	1	-	00900047	8	-	00500047	-	-	-	-	5	-
SERR. DE SURETE 140 x 90 mm gauche	00000057	1	-	00900057	8	-	00500057	-	-	-	-	5	-

Non stocké/Non-stored/Producto no estocado - Sur stock Europe Zone 1 et Zone 2, nous consulter pour délai d'approvisionnement - Epuiseiment/Stock depletion/Agotamiento del stock

Serrure de garage / POUR CYLINDRE PROFILE

PROTECT



GARANTIE



X 3

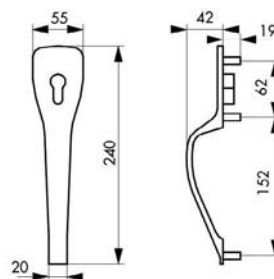
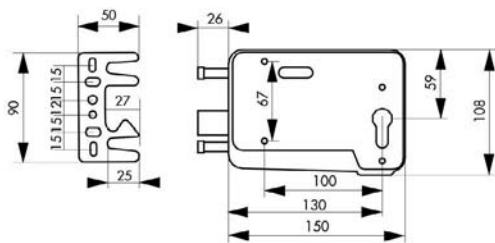

Description/Description/Descripción

Couverture acier avec ceinture PVC. Gâche plate acier. Pêne bronze d'aluminium. Condamnation et décondamnation intérieure par bouton. Arrêt de portillon incorporé. Accessoires : poignée extérieure PVC, équerre pour gâche plate.

Steel cover with PVC belt. Steel flat striker. Aluminium bronze bolt. Inside locking and unlocking by knob. Door stop included. Accessories : PVC outside handle, square plate for flat striker.

Cubierta de acero con cinturón de PVC. Cerradero plano de acero. Pestillo de bronce de aluminio. Condensación y descondensación interior por botón. Parada de portillo incorporada. Accesorios: tirador exterior de PVC escuadra para cerradero plano.

Finition/Finish/Acabado

Gris

Grey

Gris

Version/Option/Versión

Avec demi-cylindre profilé européen 30 x 10 mm, pour porte ép. 25 mm maxi, 3 clés.

With european profile cylinder 30 x 10 mm, for 25 mm thickness door, 3 keys.

Con semicilindro perfilado europeo 30 x 10 mm, para puerta de 25 mm de espesor como máximo, 3 llaves

Utilisation/Use/Utilización

Porte de garage à portillon droite ou gauche

Swing garage door right or left hand

Puertas de garaje con portillo derecha o izquierda

Designation	Boîte	Colis.	Prix	Sachet	Colis.	Prix	Brochable					Colis.	Prix
							France	Euro 1	Euro 2	Euro 3	Euro 4		
SERRURE DE SURETE cyl. 30x10 3 clés réver. pour porte bois ou PVC	00000067	1	-	-	-	-	00500067	-	-	-	-	5	-
BOIT. cyl. réver. pour porte bois ou PVC	00000069	1	-	00900069	10	-	00500069	-	-	-	-	5	-
POIGNEE seule	00000167	10	-	00900167	10	-	00400167	-	-	-	-	10	-
EQUERRE pour gâche plate	00000267	10	-	-	-	-	-	-	-	-	-	-	-

Ⓜ Non stocké/Non-stored/Producto no estocado - ☑ Sur stock Europe Zone 1 et Zone 2, nous consulter pour délai d'approvisionnement - ☒ Epuisement/Stock depletion/Agotamiento del stock

Serrure de garage / PORTE BASCULANTE

PROTECT



GARANTIE

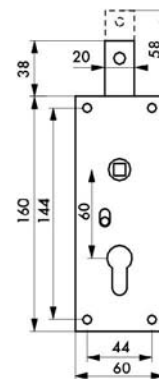
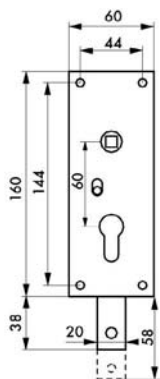

Description/Description/Descripción

Coffre acier cambré. 1 point de condamnation. Bouton de décondamnation intérieur. Carré 7 mm. Accessoires : poignée double pour serrure, poignée de tirage pour porte basculante.

Cambered steel case. 1 locking point. . Square 7 mm. Accessories : double handle for lock, pulling handle. for rocking door

Caja de acero curvado. 1 punto de condenación. Botón de descondenación interior. Cuadrado 7 mm. Accesorios: tirador doble para cerradura, tirador para puerta basculante

Finition/Finish/Acabado

Zingué / Zinc plated / Cincado

Version/Option/Versión

1 point haut ou 1 point bas. Avec demi-cylindre profilé européen 30 x 10 mm, pour porte ép. 20 mm, 3 clés.

1 up or down locking point With european profile cylinder 30 x 10 mm, for 20 mm thickness door, 3 keys.

1 punto alto o 1 punto bajo

Utilisation/Use/Utilización

Utilisation/

Use/

Utilización



Designation	Boite	Colis.	Prix	Sachet	Colis.	Prix	Brochable					Colis.	Prix
							France	Euro 1	Euro 2	Euro 3	Euro 4		
BOIT. VERT à cyl. prof. carré 7 mm 1 PT bas	00096564	5	-	00996564	10	-	00496564	00493960 NS	-	00494960	-	5	-
BOIT. VERT à cyl. prof. carré 7 mm 1 PT haut	00096566	5	-	00996566	10	-	00496566	00493961 NS	-	00494961	-	5	-
POIGNEE T. double carré 7 mm noir pour réf.096568	00000434	10	-	00900434	10	-	00500434	00593962 NS	-	00594962	-	10	-
POIGNEE tirage pour porte basculante	00000435	10	-	00900435	10	-	00100435	00193963 NS	-	00194963	-	10	-

NS Non stocké/Non-stored/Producto no estocado - Sur stock Europe Zone 1 et Zone 2, nous consulter pour délai d'approvisionnement - E Epuisement/Stock depletion/Agotamiento del stock

Serrure de garage / PORTE BASCULANTE

PROTECT



GARANTIE

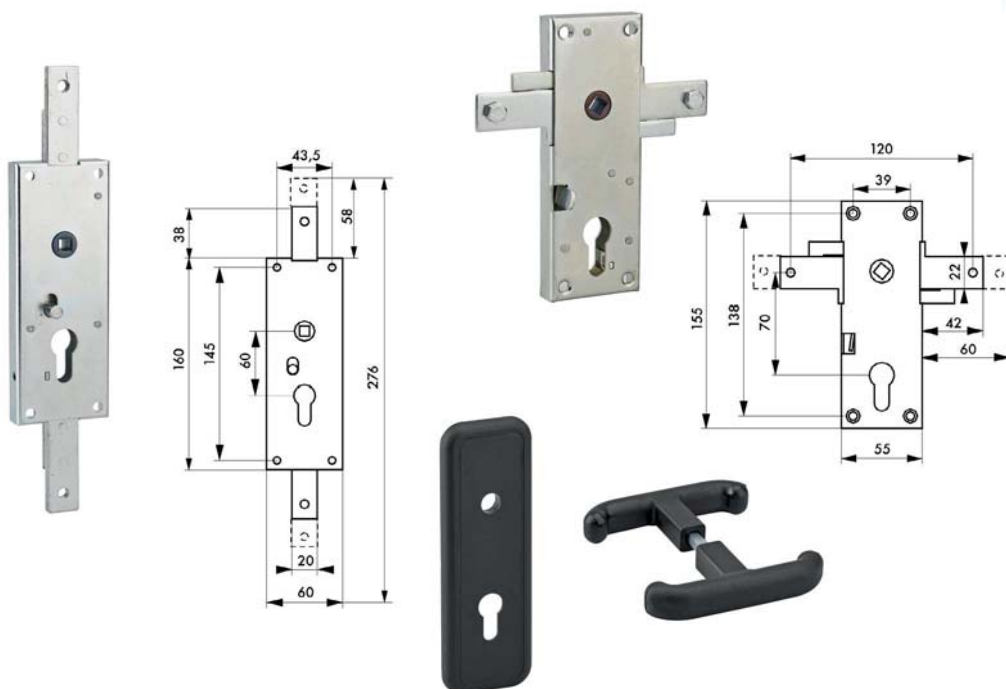

Description/Description/Descripción

Coffre acier cambré. 2 points de condamnation. Bouton de décondamnation intérieur. 096568 : Mécanisme bec de cane. Carré 7 mm. 096562 : Mécanisme pêne dormant. Carré 8 mm.

Cambered steel case. 2 locking points. Inside unlocking knob. 096568 : Latch mechanism. Square 7 mm. 096562 : Bolt mechanism. Square 8 mm.

Caja de acero curvado. 2 puntos de condenación. Botón de descondenación interior. 096568 : Mecanismo resbalón. Cuadrado 7 mm. 096562 : Mecanismo pestillo durmiente. Cuadrado 8 mm.

Finition/Finish/Acabado

Zingué
Zinc plated
Cincado

Utilisation/Use/Utilización

Porte de garage basculante
Rocking garage door
Puertas de garaje basculantes

Designation	Boite	Colis.	Prix	Sachet	Colis.	Prix	Brochable					Colis.	Prix
							France	Euro 1	Euro 2	Euro 3	Euro 4		
BOITIER vertical à cylindre profilé carré 7 mm 2 POINTS haut et bas	00096568	5	-	00996568	10	-	00496568	00493964 NS	-	00494964	-	5	-
BOITIER vertical à cylindre profilé carré 8 mm 2 POINTS latéraux	00096562	5	-	00996562	10	-	00396562	00493965 NS	-	00494965	-	2	-
POIGNEE T. double carré 7 mm noir pour réf.096568	00000434	10	-	00900434	10	-	00500434	-	-	-	-	10	-
POIGNEE et plaque de propreté E70 pour serr. porte basculante ? 8 mm pour réf. 096562	00000433	10	-	00900433	10	-	00500433	00593966 NS	-	00594966	-	2	-
POIGNEE double carré 8 mm pour réf. 096562	00000432	10	-	-	-	-	-	-	-	-	-	-	-
POIGNEE T. double carré 8 mm noir pour réf. 096562	00000443	10	-	-	-	-	-	-	-	-	-	-	-
POIGNEE tirage pour porte basculante	00000435	10	-	00900435	10	-	00100435	-	-	-	-	10	-
Plaque de propreté 186 x 62 mm E60 mm pour réf. 096564 / 096566	00000444	10	-	00900444	10	-	-	-	-	-	-	-	-

NS Non stocké/Non-stored/Producto no estocado - E Sur stock Europe Zone 1 et Zone 2, nous consulter pour délai d'approvisionnement - E Epusement/Stock depletion/Agotamiento del stock

Serrure de grille et portail / PÊNE DORMANT 1/2 TOUR

ECO

Serrure de grille et portail de sûreté
offrant une protection anti corrosion

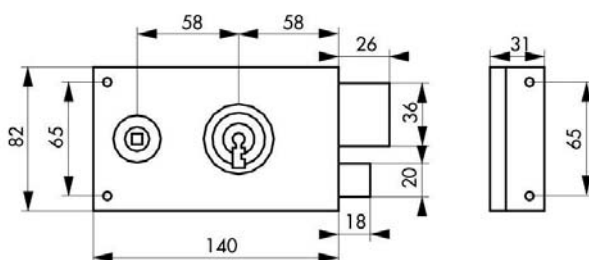

GARANTIE



X 2

Description/Description/Descripción

Coffre et gâche acier cambré. Pêne et demi-tour acier. Canon acier longueur 35 mm. Entrée de clé laiton sur coffre. Mécanisme à 2 tours. Pêne 1/2 tour réversible pour porte ouvrant à l'extérieur. Carré 6 mm - 2 clés nickelées - 6 variures. Entrée de clé et de fouillot acier. *Cambered steel case. and striker. Steel bolt and latch 5 mm projection. Steel bush 35 mm length. Brass key hole on case. Double latch mechanism. Reversible latch bolt for outside opening door. Square 6 mm. 2 nickel plated keys. 6 key differs. Steel key hole and follower plate.*

Caja y cerradero de acero curvado. Pestillo y media vuelta de acero. en saliente de 5 mm. Cañón de acero, long. 35 mm. Entrada de llave de latón en caja. Mecanismo de 2 vueltas. Pestillo media vuelta reversible para puerta con apertura hacia el exterior. Cuadrado 6 mm. 2 llaves niqueladas. 6 perfiles de llave. Entrada de llave y de nuez de acero.

Finition/Finish/Acabado

Zingué
Zinc plated
Cincado

Versión/Option/Versión

Droite et gauche Ref 000119 - 000129 :Pêne et demi-tour acier en saillie de 5 mm
Right and left hand
Derecha e izquierda



Designation	Boite	Colis.	Prix	Sachet	Colis.	Prix	Brochable					Colis.	Prix
							France	Euro 1	Euro 2	Euro 3	Euro 4		
SERR. PDT 1/2 tour zinguée 140 x 82 mm D	00000119	1	-	00900119	5	-	00500119	-	-	-	-	5	-
SERR. PDT 1/2 tour zinguée 140 x 82 mm G	00000129	1	-	00900129	5	-	00500129	-	-	-	-	5	-
SERR. PDT 1/2 tour SL zinguée 140 x 82 mm D	00001119	1	-	00901119	10	-	00501119	-	-	-	-	5	-
SERR. PDT 1/2 tour SL zinguée 140 x 82 mm G	00001129	1	-	00901129	10	-	00501129	-	-	-	-	5	-

Non stocké/Non-stored/Producto no estocado - Sur stock Europe Zone 1 et Zone 2, nous consulter pour délai d'approvisionnement - Epuement/Stock depletion/Agotamiento del stock

Serrure de grille et portail / PÊNE DORMANT 1/2 TOUR

ECO



GARANTIE



X 2

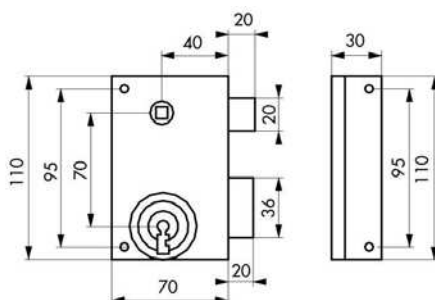

Description/Description/Descripción

Coffre et gâche acier cambré. Pêne et demi-tour acier. Canon acier longueur 35 mm. Mécanisme à 1 tour. Pêne 1/2 tour réversible pour porte ouvrant à l'extérieur. Carré 7 mm. 2 clés nickelées. 6 variures. Entrée de clé et de fouillot acier

Cambered steel case and striker. Steel bolt and latch 5 mm projection. Steel bush 35 mm length. Single latch mechanism. Reversible latch bolt for outside opening door. Square 7 mm. 2 nickel plated keys. 6 key differs. Steel key hole and follower plate.

Caja y cerradero de acero curvado. Pestillo y media vuelta de acero en saliente de 5 mm. Cañón de acero long. 35 mm. Mecanismo de 1 vuelta. Pestillo media vuelta reversible para puerta con apertura hacia el exterior. Cuadrado 7 mm. 2 llaves niqueladas. 6 perfiles de llave. Entrada de llave y de nuez de acero.

Finition/Finish/Acabado

Zingué

Zinc plated

Cincado

Version/Option/Versión

Droite et gauche Ref 000130 - 000140 :Pêne et demi-tour acier en saillie de 5 mm

Right and left hand

Derecha e izquierda

Designation	Boite	Colis.	Prix	Sachet	Colis.	Prix	Brochable					Colis.	Prix
							France	Euro 1	Euro 2	Euro 3	Euro 4		
SERR. PDT 1/2 tour zinguée 70 x 110 mm D	00000130	1	-	00900130	5	-	00300130	-	-	-	-	5	-
SERR. PDT 1/2 tour zinguée 70 x 110 mm G	00000140	1	-	00900140	5	-	00300140	-	-	-	-	5	-
SERR. PDT 1/2 tour SL zinguée 70 x 110 mm D	00001139	1	-	00901139	10	-	00301139	-	-	-	-	5	-
SERR. PDT 1/2 tour SL zinguée 70 x 110 mm G	00001149	1	-	00901149	10	-	00301149	-	-	-	-	5	-

⚠ Non stocké/Non-stored/Producto no estocado - 📦 Sur stock Europe Zone 1 et Zone 2, nous consulter pour délai d'approvisionnement - 📦 Epuisement/Stock depletion/Agotamiento del stock

Serrure de grille et portail / 4 GORGES

PROTECT



GARANTIE



X 2

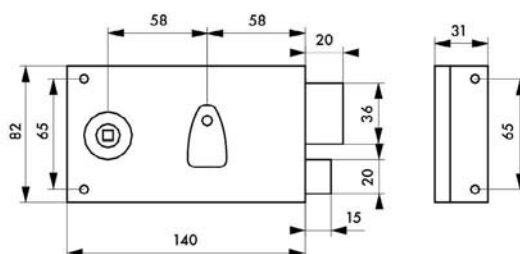

Description/Description/Descripción

Coffre et gâche acier cambré. Pêne et demi-tour acier.
 Revêtement anti-corrosion. Canon alliage long. 40 mm.
 Mécanisme à 4 gorges laiton 2 tours. 2 clés nickelées. 1
 2 variures. Pêne 1/ 2 tour réversible pour porte ouvrant à
 l'extérieur. Carré 6 mm. Entrée de clé et de fouillot acier.
*Cambered steel case and striker. Steel bolt and latch.
 Anticorrosion 40 mm alloy bush. 4 brass lever mechanism
 double latch mechanism. Latch bolt reversible for outside
 opening door. Square 6 mm. Entry of key and of follower plate.*

Caja y cerradero de acero curvado. Pestillo y media
 vuelta de acero. Anticorrosión Cañón de aleación, long.
 40 mm. Mecanismo de 4 canalillos de latón y 2 vueltas.
 2 llaves niqueladas - 12 perfiles de llave. Pestillo de
 media vuelta reversible para puerta con apertura hacia el
 exterior. Cuadrado 6 mm. Entrada de llave y de nuez de
 acero

Finition/Finish/Acabado

Epoxy noir granité
*Granited black epoxy
 Epoxi negro granitado*

Version/Option/Versión

Droite et gauche.
*Right and left hand.
 Derecha e izquierda.*



Designation	Boite	Colis.	Prix	Sachet	Colis.	Prix	Brochable					Colis.	Prix
							France	Euro 1	Euro 2	Euro 3	Euro 4		
SERR. 4 gorges à fouillot 140x82 mm droite	-	-	-	-	-	-	00509113	-	-	-	-	5	-
SERR. 4 gorges à fouillot 140x82mm gauche	-	-	-	-	-	-	00509123	-	-	-	-	5	-

Non stocké/Non-stored/Producto no estocado - Sur stock Europe Zone 1 et Zone 2, nous consulter pour délai d'approvisionnement - Epuisement/Stock depletion/Agotamiento del stock

Serrure de grille et portail / 4 GORGES, A CROCHET PROTECT



GARANTIE



X 2

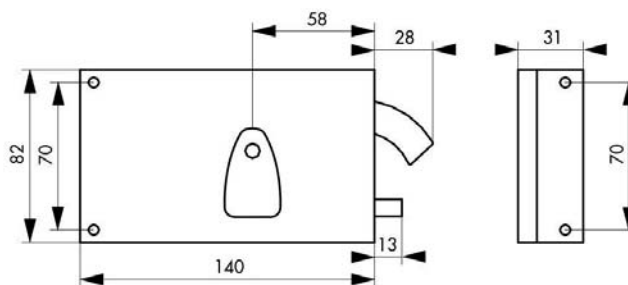
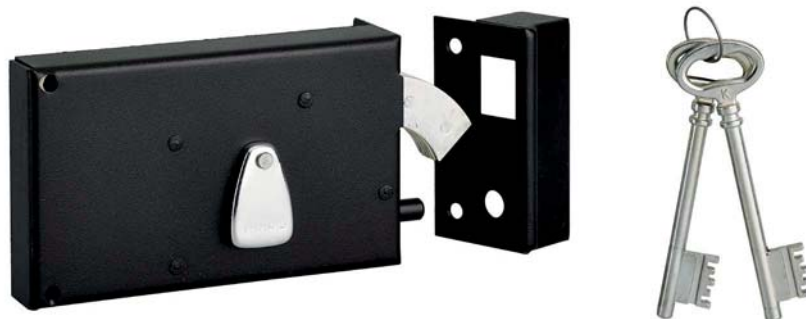

Description/Description/Descripción

Coffre et gâche acier cambré. Crochet acier. Canon alliage long. 40 mm. Mécanisme à 4 gorges laiton 1 tour. 2 clés nickelées. 12 variures. Entrée de clé acier.

Cambered steel case and striker. Steel bolt. 40 mm alloy bush. 4 brass levers mechanism. 2 nickel plated keys. 12 key differs. Steel key hole plate.

Caja y cerradero de acero curvado. Pestillo de acero. Cañón de aleación, long. 40 mm. Mecanismo de 4 canalillos de latón. 2 llaves niquelada. 12 perfiles de llave. Entrada de llave de acero.

Finition/Finish/Acabado

Epoxy noir granité
Granited black epoxy
Epoxi negro granitado

Utilisation/Use/Utilización

Porte coulissante
Use Inside sliding door
Puerta interior corredera

Designation	Boite	Colis.	Prix	Sachet	Colis.	Prix	Brochable					Colis.	Prix
							France	Euro 1	Euro 2	Euro 3	Euro 4		
SERR. 4 gorges à crochet 140 x 82 mm droite	00000118	1	-	-	-	-	00500118	-	-	-	-	5	-
SERR. 4 gorges à croche 140 x 82 mm gauche	00000128	1	-	-	-	-	00500128	-	-	-	-	5	-

⚠ Non stocké/Non-stored/Producto no estocado - 📦 Sur stock Europe Zone 1 et Zone 2, nous consulter pour délai d'approvisionnement - 📦 Epuisement/Stock depletion/Agotamiento del stock

Serrure de grille et portail / 4 GORGES

PROTECT



GARANTIE



X 2

Serrure de grille et portail, de sûreté, offrant une protection anti corrosion.

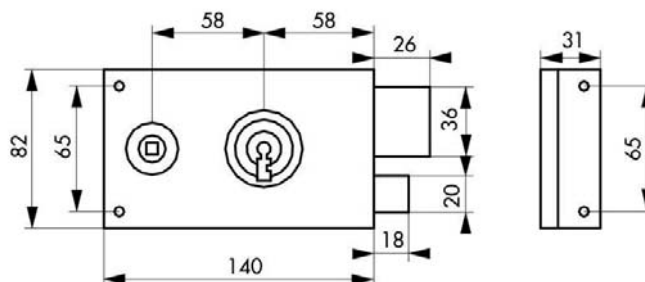

Description/Description/Descripción

Coffre et gâche acier cambré. Pêne et demi-tour acier en saillie de 5 mm. Canon alliage longueur 40 mm. Entrée de clé laiton sur coffre. Mécanisme à 4 gorges laiton, 2 tours. Pêne 1/ 2 tour réversible pour porte ouvrant à l'extérieur. Carré 6 mm. 2 clés nickelées. 12 variures. Entrée de clé et de fouillot acier.

Cambered steel case and striker. Steel bolt and latch 5 mm projection. Alloy bush 40 mm length. Brass key hole on case. 4 brass lever mechanism. Double latch. Reversible latch bolt for outside opening door. Square 6 mm - 2 nickel plated keys. 12 key differs. Steel key hole and follower plate.

Caja y cerradero de acero curvado. Pestillo y media vuelta de acero en saliente de 5 mm. Cañón de aleación, long. 40 mm. Entrada de llave de latón en la caja. Mecanismo de 4 canalillos de latón, 2 vueltas. Pestillo media vuelta reversible para puerta con apertura hacia el exterior. Cuadrado 6 mm. 2 llaves níqueladas. 12 perfiles de llave. Entrada de llave y de nuez de acero.

Finition/Finish/Acabado

Zingué
Zinc plated
Cincado

Versión/Option/Versión

Droite et gauche
Right and left hand
Derecha e izquierda



Designation	Boite	Colis.	Prix	Sachet	Colis.	Prix	Brochable					Colis.	Prix
							France	Euro 1	Euro 2	Euro 3	Euro 4		
SERRURE DE GRILLE 140 x 82 mm droite	00002113	1	-	-	-	-	00502113	-	-	-	-	5	-
SERRURE DE GRILLE 140 x 82 mm gauche	00002123	1	-	-	-	-	00502123	-	-	-	-	5	-

Non stocké/Non-stored/Producto no estocado - Sur stock Europe Zone 1 et Zone 2, nous consulter pour délai d'approvisionnement - Epuement/Stock depletion/Agotamiento del stock

Serrure de grille et portail / INOX, 4 GORGES

RESIST



GARANTIE



X 2



Serrure de grille et portail, de sûreté, offrant une protection contre la corrosion.

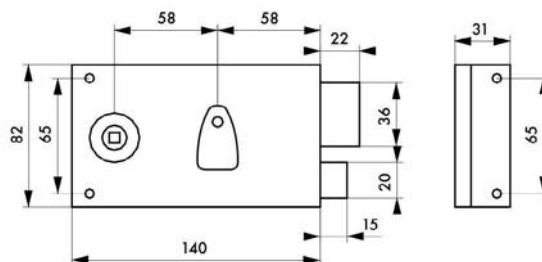

Description/Description/Descripción

Coffre et gâche inox 304L poli cambré. Pêne et demi-tour laiton chromé. Cache entrée inox sur coffre. Mécanisme à 4 gorges laiton, 2 tours. Pêne 1/2 tour réversible pour porte ouvrant à l'extérieur. Carré 6 mm. 2 clés nickelées. 2 variures. Entrée de clé et de fouillot inox.

Cambered stainless steel 304L case and striker. Brass plated bolt and latch. Brass plated bush 40 mm length. 4 brass lever mechanism. Double latch. Reversible latch bolt for outside opening door. Square 6 mm - 2 nickel plated keys. 24 key differs. Stainless steel key hole and follower plate.

Caja y cerradero de acero inoxidable 304L curvado. Pestillo y media vuelta de latón cromado. Cañón de acero inoxidable, long. 40 mm. Mecanismo de 4 canalillos de latón, 2 vueltas. Pestillo media vuelta reversible para puerta con apertura hacia el exterior. Cuadrado 6 mm. 2 llaves níqueladas. 24 perfiles de llave. Entrada de llave y de nuez de acero inoxidable.

Finition/Finish/Acabado

Inox poli
Polished stainless steel
Acero inoxidable pulido

Version/Option/Versión

Droite et gauche
Right and left hand
Derecha e izquierda

Designation	Boite	Colis.	Prix	Sachet	Colis.	Prix	Brochable					Colis.	Prix
							France	Euro 1	Euro 2	Euro 3	Euro 4		
SERRURE DE GRILLE 140 x 82 mm droite	-	-	-	-	-	-	00509219	-	-	-	-	2	-
SERRURE DE GRILLE 140 x 82 mm gauche	-	-	-	-	-	-	00509229	-	-	-	-	2	-

⚠ Non stocké/Non-stored/Producto no estocado - 📦 Sur stock Europe Zone 1 et Zone 2, nous consulter pour délai d'approvisionnement - 📦 Epuisement/Stock depletion/Agotamiento del stock

Serrure de grille et portail / 4 GORGES

PROTECT



GARANTIE



X 2

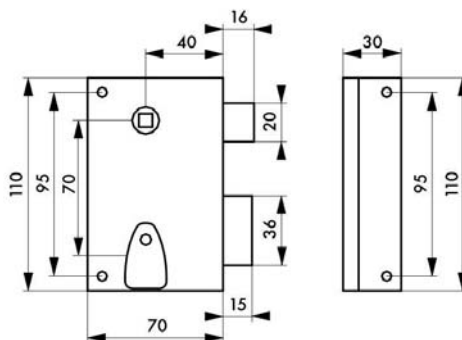

Description/Description/Descripción

Coffre et gâche acier cambré. Pêne acier. Demi-tour acier. Canon alliage long. 40 mm. Mécanisme à 4 gorges 2 tours avec tirage ou à fouillot. Pêne 1/2 tour réversible pour porte ouvrant à l'extérieur. Carré 7 mm. 2 clés nickelées. 12 variures. Entrée de clé et de fouillot acier. A TIRAGE : Rappel du demi-tour par la clé
Cambered steel case and striker. Steel bolt - Steel latch. Alloy bush 40 mm length. 4 lever mechanism double latch with drawback pull and follower. Drawback of the latch by key. Latch bolt reversible for outside opening door. Square 7 mm. 2 nickel plated keys. 12 key differs. Steel key hole and follower plate.

Caja y cerradero de acero curvado. Pestillo de acero. Media vuelta de acero. Cañón de aleación, long. 40 mm. Mecanismo de 4 canalillos 2 vueltas con tirador o de nuez. Reposición de la media vuelta con la llave. Pestillo de media vuelta reversible para puertas con apertura hacia el exterior. Cuadrado 7 mm. 2 llaves niqueladas. 12 perfiles de llave. Entrada de la llave y de la nuez de acero.

Finition/Finish/Acabado

Epoxy noir granité
Granited black epoxy
 Epoxi negro granitado

Versión/Option/Versión

Droite et gauche. 309133-309143 : Revêtement anti-corrosion
Right and left hand. 309133-309143 Anticorrosion.
 Derecha e izquierda. 309133-309143 Anticorrosión



Designation	Boite	Colis.	Prix	Sachet	Colis.	Prix	Brochable				Colis.	Prix	
							France	Euro 1	Euro 2	Euro 3			Euro 4
SERRURE à fouillot 70 x 110 mm droite	-	-	-	-	-	-	00309133	-	-	-	-	5	-
SERRURE à fouillot 70 x 110 mm gauche	-	-	-	-	-	-	00309143	-	-	-	-	5	-

Non stocké/Non-stored/Producto no estocado - Sur stock Europe Zone 1 et Zone 2, nous consulter pour délai d'approvisionnement - Epuement/Stock depletion/Agotamiento del stock

Serrure de grille et portail / 6 GORGES

RESIST



GARANTIE



X 2

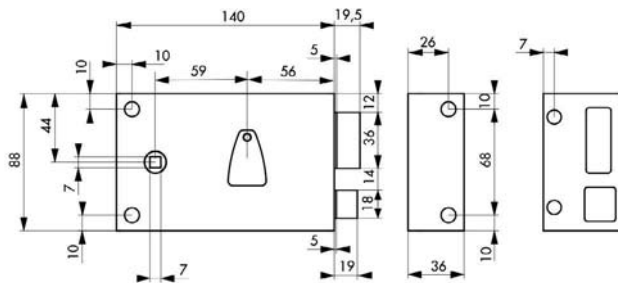

Description/Description/Descripción

Coffre et gâche acier cambré. Pêne et demi-tour acier en saillie de 5 mm. Canon alliage longueur 45 mm. Entrée de clé acier sur coffre. Mécanisme à 6 gorges, 2 tours. Carré 7 mm. 2 clés nickelées. 2 variures. Entrée de clé acier. Fouillot laiton.

Cambered steel case and striker. Steel bolt and latch 5 mm projection. Alloy bush 45 mm length. Steel key hole on case. 6 lever mechanism, double latch. Square 7 mm. 2 nickel plated keys. 20 key differs. Steel key hole. Brass follower plate.

Caja y cerradero de acero curvado. Pestillo y media vuelta de acero en saliente de 5 mm. Cañón de aleación, long. 45 mm. Entrada de llave de acero en la caja.

Mecanismo de 6 canalillos, 2 vueltas. Cuadrado 7 mm. 2 llaves niqueladas. 20 perfiles de llave. Entrada de llave acero. Nuez de latón.

Finition/Finish/Acabado

Epoxy noir granité

Granited black epoxy

Epoxi negro granitado

Versión/Option/Versión

Droite et gauche

Right and left hand

Derecha e izquierda

Designation	Boite	Colis.	Prix	Sachet	Colis.	Prix	Brochable					Colis.	Prix
							France	Euro 1	Euro 2	Euro 3	Euro 4		
SERR. DE GRILLE 140x88 mm droite	00035110	1	-	-	-	-	-	-	-	-	-	-	-
SERR. DE GRILLE 140x88 mm gauche	00035120	1	-	-	-	-	-	-	-	-	-	-	-
PLAQUE DE FIXATION à souder réversible	00007966	1	-	-	-	-	-	-	-	-	-	-	-

⚠ Non stocké/Non-stored/Producto no estocado - 📦 Sur stock Europe Zone 1 et Zone 2, nous consulter pour délai d'approvisionnement - 🇪🇺 Epusement/Stock depletion/Agotamiento del stock

Serrure applique horizontale / 6 GORGES RESIST



GARANTIE



X 2

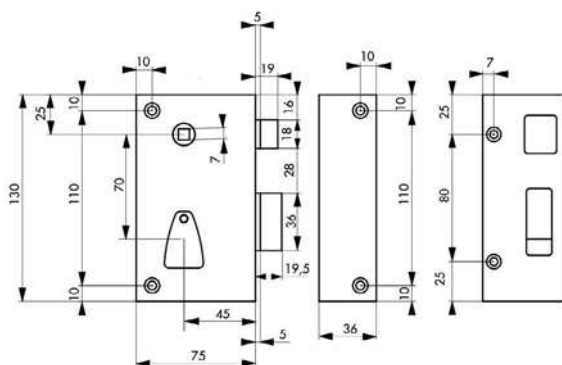

Description/Description/Descripción

Coffre et gâche acier cambré. Pêne et demi-tour acier en saillie de 5 mm. Canon alliage longueur 45 mm. Entrée de clé acier sur coffre. Mécanisme à 6 gorges, 2 tours. Carré 7 mm. 2 clés nickelées. 2 variures. Entrée de clé acier. Fouillot laiton.

Cambered steel case and striker. Steel bolt and latch 5 mm projection. Alloy bush 45 mm length. Steel key hole on case. 6 lever mechanism, double latch. Square 7 mm. 2 nickel plated keys. 20 key differs. Steel key hole. Brass follower plate.

Caja y cerradero de acero curvado. Pestillo y media vuelta de acero en saliente de 5 mm. Cañón de aleación, long. 45 mm. Entrada de llave de acero en la caja. Mecanismo de 6 canalillos, 2 vueltas. Cuadrado 7 mm. 2 llaves niqueladas. 20 perfiles de llave. Entrada de llave acero. Nuez de latón.

Finition/Finish/Acabado

Epoxy noir granité
Granited black epoxy
Epoxi negro granitado

Version/Option/Versión

Droite et gauche
Right and left hand
Derecha e izquierda



Designation	Boîte	Colis.	Prix	Sachet	Colis.	Prix	Brochable					Colis.	Prix
							France	Euro 1	Euro 2	Euro 3	Euro 4		
SERR. DE GRILLE 75 x 130 mm droite	00037110	1	-	-	-	-	-	-	-	-	-	-	-
SERR. DE GRILLE 75 x 130 mm gauche	00037120	1	-	-	-	-	-	-	-	-	-	-	-
PLAQUE DE FIXATION à souder réversible	00008966	1	-	-	-	-	-	-	-	-	-	-	-

Ⓜ Non stocké/Non-stored/Producto no estocado - Ⓜ Sur stock Europe Zone 1 et Zone 2, nous consulter pour délai d'approvisionnement - Ⓜ Epuisement/Stock depletion/Agotamiento del stock

Serrure de grille et portail / POUR CYLINDRE PROFILE PROTECT



GARANTIE

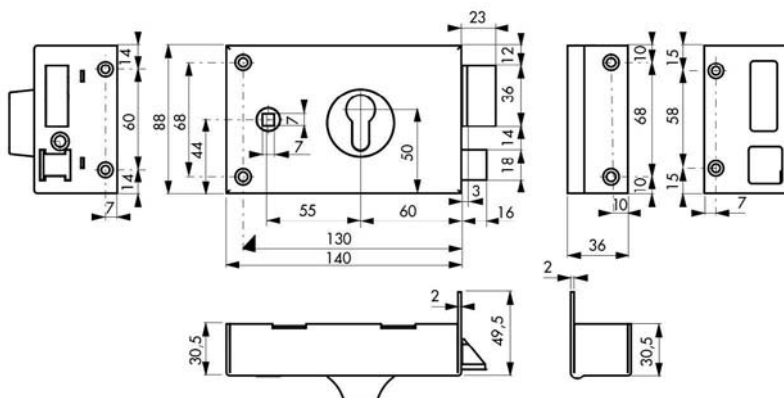

Description/Description/Descripción

Coffre et gâche acier cambré. Pêne et demi-tour en saillie de 3 mm acier zingué . Mécanisme à 2 tours. Carré 7 mm.

Cambered steel case and striker. Zinc plated steel bolt and latch 3 mm projection. Double latch mechanism. Square 7 mm.

Caja y cerradero de acero curvado. Pestillo y media vuelta de acero cincado en saliente de 3 mm. Mecanismo de 2 vueltas. Cuadrado 7 mm.

Finition/Finish/Acabado

Epoxy noir granité

Granited black epoxy

Epoxi negro granitado

Versión/Option/Versión

Droite et gauche

Right and left hand

Derecha e izquierda

Designation	Boite	Colis.	Prix	Sachet	Colis.	Prix	Brochable					Colis.	Prix
							France	Euro 1	Euro 2	Euro 3	Euro 4		
BOITIER CP à fouillot 140 x 88 mm droite	00085110	1	-	00985110	10	-	-	-	-	-	-	-	-
BOITIER CP à fouillot 140 x 88 mm gauche	00085120	1	-	00985120	10	-	-	-	-	-	-	-	-
Boitier CP à fouillot pour grille 140x88mm noir - droite «poussant»	PS085110 NS	1	-	-	-	-	-	-	-	-	-	-	-
Boitier CP à fouillot pour grille 140x88mm noir - gauche «poussant»	PS085120 NS	1	-	-	-	-	-	-	-	-	-	-	-
PLAQUE DE FIXATION à souder réversible	00007966	1	-	00907966	5	-	-	-	-	-	-	-	-

NS Non stocké/Non-stored/Producto no estocado - ☐ Sur stock Europe Zone 1 et Zone 2, nous consulter pour délai d'approvisionnement - ☒ Epuisement/Stock depletion/Agotamiento del stock

Serrure applique horizontale / À CROCHET

PROTECT



GARANTIE

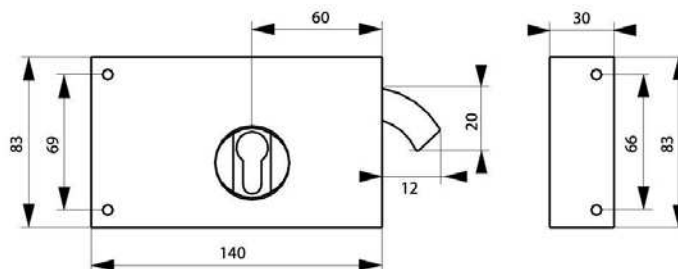

Description/Description/Descripción

Coffre et gâche acier cambré. Crochet acier zingué Mécanisme à 2 tours.

Cambered steel case and striker. Galvanised steel hook Two latch mechanism.

Caja y cerradero de acero curvado. Pestillo de gancho acero cincado. Media vuelta de acero. Mecanismo de 2 vueltas.

Finition/Finish/Acabado

Zingué

Zinc plated.

Cincado.

Version/Option/Versión

Droite et gauche

Right and left hand

Derecha e izquierda



Designation	Boîte	Colis.	Prix	Sachet	Colis.	Prix	Brochable					Colis.	Prix
							France	Euro 1	Euro 2	Euro 3	Euro 4		
BOITIER CP à crochet 140 x 83 mm droite	00008118 <small>NS</small>	1	-	-	-	-	00508118	-	-	-	-	2	-
BOITIER CP à crochet 140 x 83 mm gauche	00008128 <small>NS</small>	1	-	-	-	-	00508128	-	-	-	-	2	-
Boitier de serrure CP à crochet 140 x 83mm zinguée droite	00009119 <small>NS</small>	1	-	-	-	-	00509119	-	-	-	-	2	-
BOITIER CP à crochet 140 x 83 mm gauche Z	00009129 <small>NS</small>	1	-	-	-	-	00509129	-	-	-	-	2	-

NS Non stocké/Non-stored/Producto no estocado - Sur stock Europe Zone 1 et Zone 2, nous consulter pour délai d'approvisionnement - E Epuisement/Stock depletion/Agotamiento del stock

Serrure de grille et portail / POUR CYLINDRE PROFILE RESIST



GARANTIE

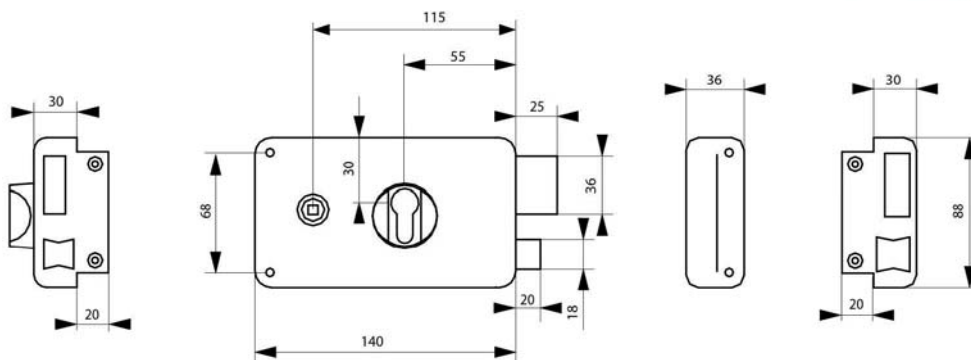
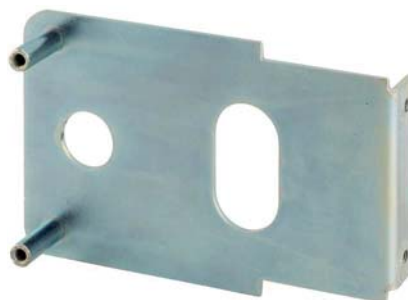

Description/Description/Descripción

Coffre et gâche acier embouté. Pêne et demi-tour acier en saillie de 5 mm. Mécanisme à 2 tours. Rappel du demi-tour par la clé. Carré 6 mm. Entrée de cylindre et de fouillot laiton.

Pressed steel case and striker. Steel bolt and latch. 5 mm projection. Double latch mechanism. Drawback of the latch by key. Square 6 mm. Brass cylinder hole and follower plate.

Caja y cerradero de acero embutido. Pestillo y media vuelta de acero en saliente de 5 mm. Mecanismo de 2 vueltas. Reposición de la media vuelta con llave. Cuadrado 6 mm. Entrada de llave y de nuez de latón.

Finition/Finish/Acabado

Epoxy noir granité
Granited black epoxy
Epoxi negro granitado

Versión/Option/Versión

Droite et gauche
Right and left hand
Derecha e izquierda

Designation	Boite	Colis.	Prix	Sachet	Colis.	Prix	Brochable					Colis.	Prix
							France	Euro 1	Euro 2	Euro 3	Euro 4		
BOITIER à cyl. profilé 140 x 88 mm drte	00009769	1	-	-	-	-	00509769	-	-	-	-	2	-
BOITIER à cyl. profilé 140 x 88 mm gche	00009779	1	-	-	-	-	00509779	-	-	-	-	2	-
PLAQUE DE FIXATION à souder pour serrure horizontale Z	00007967	10	-	00907967	10	-	-	-	-	-	-	-	-

⚠ Non stocké/Non-stored/Producto no estocado - ☑ Sur stock Europe Zone 1 et Zone 2, nous consulter pour délai d'approvisionnement - ☒ Epuisement/Stock depletion/Agotamiento del stock

Serrure de grille et portail / INOX, POUR CYLINDRE PROFILE RESIST



GARANTIE

Serrure inox anti corrosion.

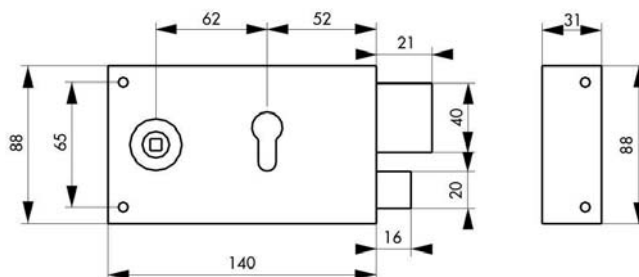

Description/Description/Descripción

Coffre et gâche inox 304 L cambré. Pêne et demi-tour laiton chromé. Mécanisme à 2 tours. Pêne 1/2 tour réversible pour porte ouvrant à l'extérieur. Carré 6 mm. Entrée de cylindre et de fouillot laiton chromé.

Cambered 304 L stainless steel case and striker. Chrome plated brass bolt and latch. Double latch mechanism. Reversible latch bolt for outside opening door. Square 6 mm. Chrome plated brass cylinder hole and follower plate.
Caja y cerradero de acero inoxidable 304 L curvado. Pestillo y media vuelta de latón cromado. Mecanismo de dos vueltas. Pestillo media vuelta reversible para puerta con apertura hacia el exterior. Cuadrado 6 mm. Entrada de cilindro y de nuez de latón cromado.

Finition/Finish/Acabado

Inox brossé
Polished stainless steel
Acero inoxidable cepillado

Version/Option/Versión

Droite et gauche
Right and left hand
Derecha e izquierda



Designation	Boite	Colis.	Prix	Sachet	Colis.	Prix	Brochable					Colis.	Prix
							France	Euro 1	Euro 2	Euro 3	Euro 4		
BOITIER CP 140 x 88 mm droite	00071900	1	-	00971900	10	-	00571900	-	-	-	-	2	-
BOITIER CP 140 x 88 mm gauche	00071901	1	-	00971901	10	-	00571901	-	-	-	-	2	-

Non stocké/Non-stored/Producto no estocado - Sur stock Europe Zone 1 et Zone 2, nous consulter pour délai d'approvisionnement - Epuement/Stock depletion/Agotamiento del stock

Serrure de grille et portail / POUR CYLINDRE PROFILE PROTECT



GARANTIE

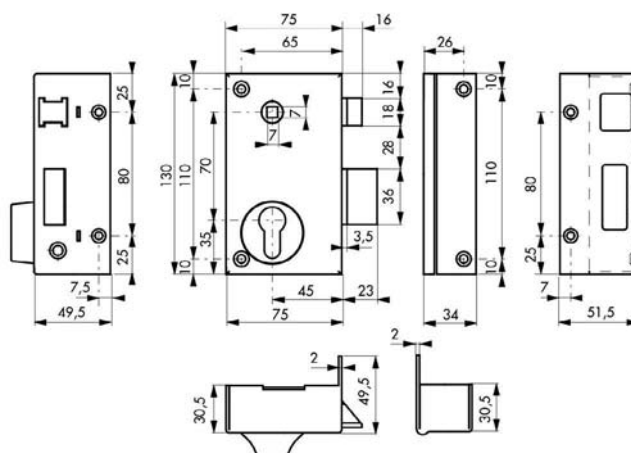

Description/Description/Descripción

Coffre et gâche acier cambré. Pêne et demi-tour en saillie de 3 mm acier zingué. Mécanisme à 2 tours. Carré 7 mm.

Cambered steel case and striker. Zinc plated steel bolt and latch 3 mm projection. Double latch mechanism. Square 7 mm.

Caja y cerradero de acero curvado. Pestillo y media vuelta de acero cincado en saliente de 3 mm. Mecanismo de 2 vueltas. Cuadrado 7 mm.

Finition/Finish/Acabado

Epoxy noir granité
Granited black epoxy
Epoxi negro granitado

Versión/Option/Versión

Droite et gauche
Right and left hand
Derecha e izquierda

Designation	Boite	Colis.	Prix	Sachet	Colis.	Prix	Brochable					Colis.	Prix
							France	Euro 1	Euro 2	Euro 3	Euro 4		
BOITIER CP à fouillot 75 x 130 mm droite	00088110	1	-	-	-	-	-	-	-	-	-	-	-
BOITIER CP à fouillot 75 x 130 mm gauche	00088120	1	-	-	-	-	-	-	-	-	-	-	-
Boitier CP à fouillot pour grille 75x130mm noir droite «poussant»	PS088110 NS	1	-	-	-	-	-	-	-	-	-	-	-
Boitier CP à fouillot pour grille 75x130mm noir gauche «poussant»	PS088120 NS	1	-	-	-	-	-	-	-	-	-	-	-
PLAQUE DE FIXATION à souder réversible	00008966	1	-	-	-	-	-	-	-	-	-	-	-

NS Non stocké/Non-stored/Producto no estocado - ☑ Sur stock Europe Zone 1 et Zone 2, nous consulter pour délai d'approvisionnement - ☒ Epuisement/Stock depletion/Agotamiento del stock

Serrure de grille et portail / PÊNE REGLABLE

PROTECT



GARANTIE

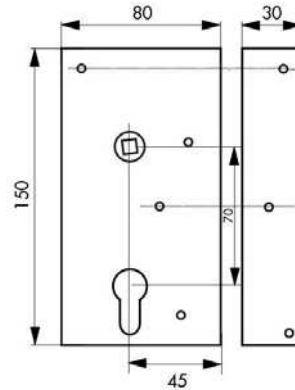

Description/Description/Descripción

Coffre et gâche en acier cambré. Pêne réglable de 18 à 30 mm par vis. Réversible tirant / poussant, droite / gauche. Mécanisme en bronze d'aluminium. Carré 7 mm.

Cambered steel case and striker. Adjustable bolt with screw. Push or draw reversible, right or left hand. Aluminium bronze mechanism. Square 7 mm.

Caja y cerradero de acero curvado. Pestillo regulable de 18 a 30 mm mediante tornillo. Reversible tirando / empujando, derecha / izquierda. Mecanismo de bronce de aluminio. Cuadrado 7 mm.

Finition/Finish/Acabado

Laqué noir

Black lacquered

Lacado negro

Utilisation/Use/Utilización

Pour tous types de portail bois

All types of wooden gate

Para todo tipo de portales de madera



Designation	Boite	Colis.	Prix	Sachet	Colis.	Prix	Brochable					Colis.	Prix
							France	Euro 1	Euro 2	Euro 3	Euro 4		
BOITIER 80 x 150 mm pêne réglable réversible	00021703	1	-	00921703	10	-	00521703	-	-	-	-	2	-

Non stocké/Non-stored/Producto no estocado - Sur stock Europe Zone 1 et Zone 2, nous consulter pour délai d'approvisionnement - Epuisement/Stock depletion/Agotamiento del stock

Serrure de grille et portail / PÊNE LEVANT

PROTECT



GARANTIE

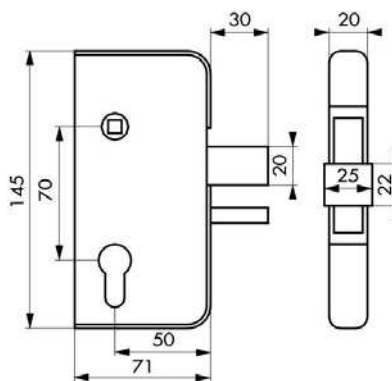

Description/Description/Descripción

Serrure entièrement inoxydable constituée d'éléments en bronze d'aluminium, inox 18/10 et laiton. Pêne en bronze d'aluminium. Enjoliveur aluminium.

Weather proof lock made of aluminium bronze, stainless steel and brass. Aluminium bronze bolt. Aluminium cover. Cerradura totalmente inoxidable constituida por elementos de bronce de aluminio, acero inoxidable 18/10 y latón. Pestillo de bronce de aluminio. Embellecedor de aluminio.

Finition/Finish/Acabado

Anodisé Argent
Silver anodized
Anodizado Plata

Version/Option/Versión

Droite et gauche. Enjoliveur aluminium pour cadre 50 x 30 mm.

Right and left hand. Aluminium cover for 50 x 30 mm frame.

Derecha e izquierda. Embellecedor de aluminio para marco 50 x 30 mm

Utilisation/Use/Utilización

Portail PVC

PVC gate

Portal PVC

Designation	Boite	Colis.	Prix	Sachet	Colis.	Prix	Brochable					Colis.	Prix
							France	Euro 1	Euro 2	Euro 3	Euro 4		
BOITIER cylindre profilé 71 x 145 mm pour portail PVC droite	00036079	1	-	-	-	-	00536079	-	-	-	-	2	-
BOITIER cylindre profilé 71 x 145 mm pour portail PVC gauche	00036179	1	-	-	-	-	00536179	-	-	-	-	2	-
ENJOLIVEUR pour cadre 50x30 mm droite	00038200	1	-	-	-	-	-	-	-	-	-	-	-
ENJOLIVEUR pour cadre 50x30 mm gauche	00038300	1	-	-	-	-	-	-	-	-	-	-	-

⚠ Non stocké/Non-stored/Producto no estocado - 📦 Sur stock Europe Zone 1 et Zone 2, nous consulter pour délai d'approvisionnement - 📦 Epuisement/Stock depletion/Agotamiento del stock

Serrure de grille et portail / PÊNE RENTRANT

PROTECT



GARANTIE

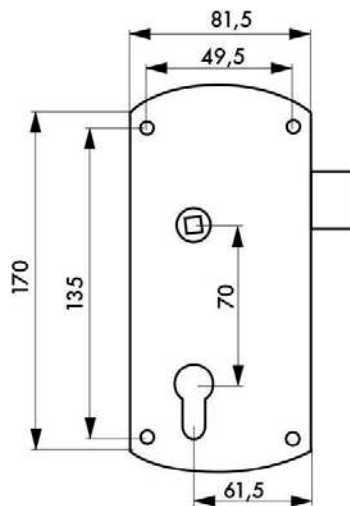

Description/Description/Descripción

Coffre et gâche en polyamide. Têtière inox. Pêne réglable de 13 mm. Réversible tirant / poussant, droite / gauche. Carré 7 mm.

Polyamide case and striker. Stainless steel forend.

Adjustable bolt 13 mm. Push or draw reversible, right or left hand. Square 7 mm.

Caja y cerradero de polyamide. Cabeza de extremos de acero inoxidable. Pestillo regulable de 13 mm. Reversible tirando / empujando, derecha / izquierda. Cuadrado 7 mm

Finition/Finish/Acabado

Noir

Black

Negro

Version/Option/Versión

Portail bois, PVC, aluminium

Wooden, aluminium and PVC gates

Para todo tipo de portales de madera, aluminio y PVC



Designation	Boite	Colis.	Prix	Sachet	Colis.	Prix	Brochable					Colis.	Prix
							France	Euro 1	Euro 2	Euro 3	Euro 4		
BOÎTIER SERRURE applique pour portail	-	-	-	00913944	1	-	00513944	-	-	-	-	5	-

⚠ Non stocké/Non-stored/Producto no estocado - 📍 Sur stock Europe Zone 1 et Zone 2, nous consulter pour délai d'approvisionnement - ⚠ Epuisement/Stock depletion/Agotamiento del stock

Serrure de grille et portail / A SOUDER PROTECT



GARANTIE

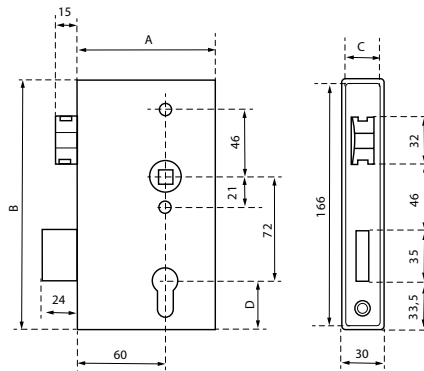

	072915 L.30mm	072916 L.40mm	072917 L.50mm
A	94	94,5	94,5
B	172	173	173
C	24	33	43
D	33,5	34	34

Description/Description/Descripción

Serrure acier zingué, coffre acier brut à souder, demi tour en saillie de 3mm, mécanisme à 2 tours, axe 60mm, carré 8mm, pour cylindre PE.

Zinc plated steel lock, steel case, latch 3mm projection, double latch mechanism, axis 60mm, square 8mm,, for european prole cylinder.

Cerradura de acero cincado, caja de acero, media vuelta en saliente de 3mm, mecanismo de 2 vueltas, eje 60mm, cuadrado 8mm, para cilindro perlado europeo.

Version/Option/Versión

Largeur 30mm, 40mm et 50mm.

Width 30mm, 40mm and 50mm.

Ancho 30mm, 40mm y 50mm.

Designation	Boite	Colis.	Prix	Brochable				Colis.	Prix
				France	Euro 1	Euro 2	Euro 3		
Boitier de serrure CP axe 60mm L30 avec coffre pour tube 30	00072915	1	-	-	-	-	-	-	-
Boitier de serrure CP axe 60mm L40 avec coffre pour tube 40	00072916	1	-	-	-	-	-	-	-
Boitier de serrure CP axe 60mm L50 avec coffre pour tube 50	00072917	1	-	-	-	-	-	-	-

⚠ Non stocké/Non-stored/Producto no estocado - 📦 Sur stock Europe Zone 1 et Zone 2, nous consulter pour délai d'approvisionnement - 📦 Epuisement/Stock depletion/Agotamiento del stock

Serrure de grille et portail / A SOUDER

PROTECT



GARANTIE

Verrouillage automatique par contre pêne avec éjection du pêne dormant dès la fermeture de la porte

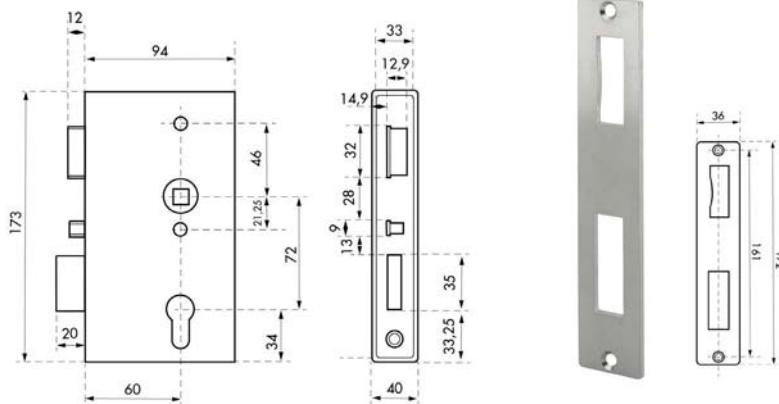

Description/Description/Descripción

Serrure acier zingué, coffre acier brut à souder, verrouillage automatique par contre pêne, axe 60mm, carré 8mm, pour cylindre PE. Ref.00072927 : gâche plate acier inoxydable double empennage, livré avec 2 vis TF M4x8.

Zinc plated steel lock, steel case, automatic locking, axis 60mm, square 8mm, for european procyliner. nd Ref.00072927 : stainless steel striker supplied with 2 M4x8 screws.

Cerradura de acero cincado, caja de acero, cierre automatico, eje 60mm, cuadrado 8mm, para cilindro perlado europeo. Ref.00072927 : cerradero de acero inoxidable suministrado con 2 tornillos M4x8.

Version/Option/Versión

Droite, Gauche.
Right hand, left hand.
Derecha, izquieda.



Designation	Boite	Colis.	Prix	Brochable				Colis.	Prix
				France	Euro 1	Euro 2	Euro 3		
Boitier de serrure CP axe 60mm L40 avec coffre pour portail - droite	00072918	1	-	-	-	-	-	-	-
Boitier de serrure CP axe 60mm L40 avec coffre pour portail - gauche	00072928	1	-	-	-	-	-	-	-
Platine de gâche 40x172mm double empennage	00072927	4	-	-	-	-	-	-	-

Non stocké/Non-stored/Producto no estocado - Sur stock Europe Zone 1 et Zone 2, nous consulter pour délai d'approvisionnement - Epuement/Stock depletion/Agotamiento del stock



GARANTIE

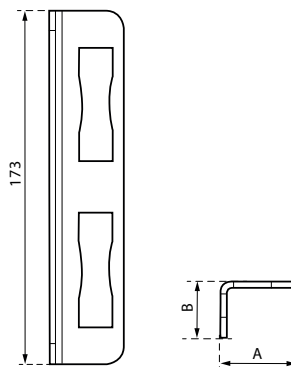

	072925	072926
A	36	45
B	30	40

Description/Description/Descripción

Acier, double empennage, réversible.

Steel, reversible.

Acero, reversible.

Version/Option/Versión

Largeur 30mm et 40mm.

Width 30mm and 40mm.

Ancho 30mm y 40mm.

Designation	Boite	Colis.	Prix	Sachet	Colis.	Prix	Brochable					Colis.	Prix
							France	Euro 1	Euro 2	Euro 3	Euro 4		
Gâche équerre à souder Larg.30mm - réversible	00072925	1	-	-	-	-	-	-	-	-	-	-	-
Gâche équerre à souder Larg.40mm - réversible	00072926	1	-	-	-	-	-	-	-	-	-	-	-

⚠ Non stocké/Non-stored/Producto no estocado - 📦 Sur stock Europe Zone 1 et Zone 2, nous consulter pour délai d'approvisionnement - ⚠ Epuisement/Stock depletion/Agotamiento del stock

Serrure de grille et portail / A VISSER - PÊNE RÉGLABLE

PROTECT



GARANTIE

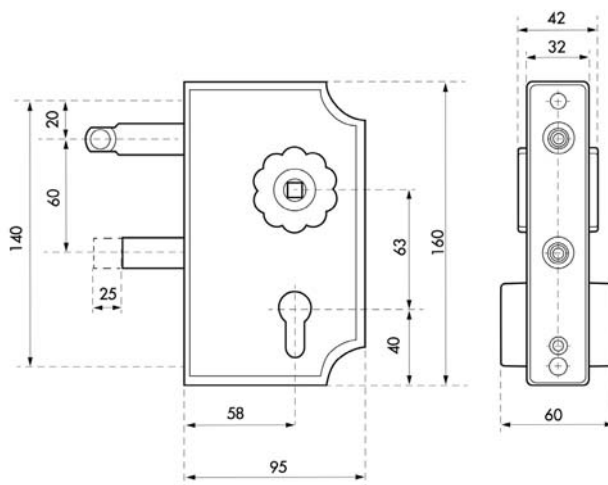

Description/Description/Descripción

Serrure acier inoxydable, boîtier aluminium. Pêne dormant réglable pour tube de 30 à 60mm. Réversible, mécanisme à 1 tour, carré 8mm, axe 58mm, EA 63mm. (référence BLISTER livrée avec gâche).

Stainless steel lock, aluminium case. Adjustable bolt for 30-60 mm. Reversible, single latch mechanism, square 8mm, axis 58mm. (reference BLISTER delivered with striker).

Cerradura de acero inoxidable, caja de aluminio. Pestillo regulable de 30 a 60mm. Reversible, mecanismo de una vuelta, cuadrado 8mm, eje de 58mm. (referencia BLISTER se entrega con gacheta).

Finition/Finish/Acabado

Aluminium, noir 9005, vert 6005

Aluminium, black, green

Aluminio, negro, verde



Designation	Boite	Colis.	Prix	Sachet	Colis.	Prix	Brochable					Colis.	Prix
							France	Euro 1	Euro 2	Euro 3	Euro 4		
BOITIER SERRURE rustique noir pour portail	00072913	1	-	00972913	10	-	00572913	-	-	-	-	10	-
Gâche rustique noir à visser pour portail	00072923	1	-	00972923	10	-	-	-	-	-	-	-	-

⚠ Non stocké/Non-stored/Producto no estocado - 📦 Sur stock Europe Zone 1 et Zone 2, nous consulter pour délai d'approvisionnement - ⚠ Epuïsement/Stock depletion/Agotamiento del stock

Serrure de grille et portail / A VISSER - PÊNE RÉGLABLE

PROTECT



GARANTIE

Disponible
en 3 finitions :



Alu



RAL 9005



RAL 6005

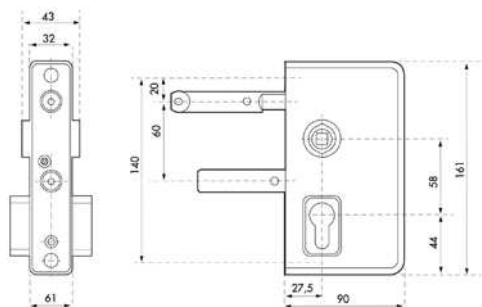

Description/Description/Descripción

Serrure acier inoxydable, boîtier aluminium. Pêne dormant réglable pour tube de 30 à 60mm. Réversible, mécanisme à 1 tour, carré 8mm, axe 58mm, EA 63mm. (référence BLISTER livrée avec gâche).

Stainless steel lock, aluminium case. Adjustable bolt for 30-60 mm. Reversible, single latch mechanism, square 8mm, axis 58mm. (reference BLISTER delivered with striker).

Cerradura de acero inoxidable, caja de aluminio. Pestillo regulable de 30 a 60mm. Reversible, mecanismo de una vuelta, cuadrado 8mm, eje de 58mm. (referencia BLISTER se entrega con gacheta).

Finition/Finish/Acabado

Aluminium, noir 9005, vert 6005.

Aluminium, black, green.

Aluminio, negro, verde.

Designation	Boite	Colis.	Prix	Sachet	Colis.	Prix	Brochable					Colis.	Prix
							France	Euro 1	Euro 2	Euro 3	Euro 4		
BOITIER SERRURE alu	00072940	1	-	-	-	-	00572940	-	-	-	-	10	-
Gâche à visser - finition alu	00072920	1	-	-	-	-	-	-	-	-	-	-	-
BOITIER SERRURE noir 9005	00072941	1	-	00972941	10	-	00572941	-	-	-	-	10	-
GÂCHE à visser noir 9005	00072921	1	-	00972921	10	-	-	-	-	-	-	-	-
BOITIER SERRURE vert 6005	00072942	1	-	-	-	-	00572942	-	-	-	-	10	-
Gâche à visser - vert 6005	00072922	1	-	-	-	-	-	-	-	-	-	-	-
Support aluminium pour tube rond de diamètre 34 à 60mm	00072924	1	-	00972924	10	-	-	-	-	-	-	-	-

⚠ Non stocké/Non-stored/Producto no estocado - 📦 Sur stock Europe Zone 1 et Zone 2, nous consulter pour délai d'approvisionnement - 📦 Epuisement/Stock depletion/Agotamiento del stock

Serrure de grille et portail / POUR CYLINDRE PROFILE RESIST



GARANTIE



Idéal pour grille avec possibilité de plaque à souder

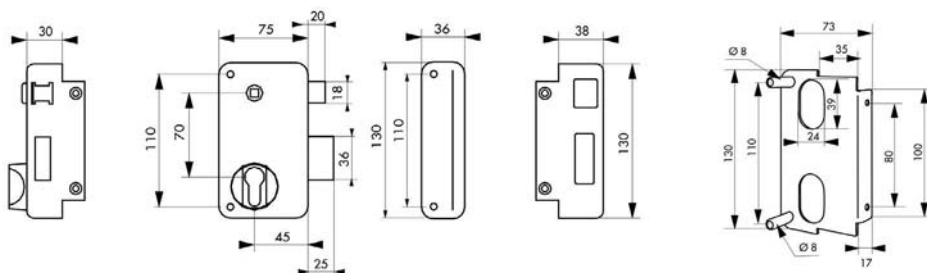

Description/Description/Descripción

Coffre et gâche acier embouté. Pêne et demi-tour acier en saillie de 5 mm. Mécanisme à 2 tours. Rappel du demi-tour par la clé. Carré 7 mm. Entrée de cylindre et de fouillot laiton.

Pressed steel case and striker. Steel bolt and latch. 5 mm projection. Double latch mechanism. Drawback of the latch by key. Square 7 mm. Brass cylinder hole plate
Caja y cerradero de acero embutido. Pestillo y media vuelta de acero en saliente de 5 mm. Mecanismo de 2 vueltas. Reposición de la media vuelta con la llave. Cuadrado 7 mm. Entrada de cilindro y de nuez de latón.

Finition/Finish/Acabado

Epoxy noir granité
Galvanised black epoxy
Cincado epoxi negro

Version/Option/Versión

Droite et gauche
Right and left hand
Derecha e izquierda



Designation	Boite	Colis.	Prix	Sachet	Colis.	Prix	Brochable					Colis.	Prix
							France	Euro 1	Euro 2	Euro 3	Euro 4		
BOIT. à cyl. profilé 75 x 130 mm droite	00009819	1	-	-	-	-	00309819	-	-	-	-	2	-
BOIT. à cyl. profilé 75x130 mm gauche	00009829	1	-	-	-	-	00309829	-	-	-	-	2	-
PLAQUE DE FIXATION à souder pour serrure verticale Z	00008967	10	-	00908967	10	-	-	-	-	-	-	-	-

⚠ Non stocké/Non-stored/Producto no estocado - 📦 Sur stock Europe Zone 1 et Zone 2, nous consulter pour délai d'approvisionnement - 🇪🇺 Epuisement/Stock depletion/Agotamiento del stock

Serrure de grille et portail / INOX, POUR CYLINDRE PROFILE RESIST



GARANTIE



Serrure inox anti corrosion.

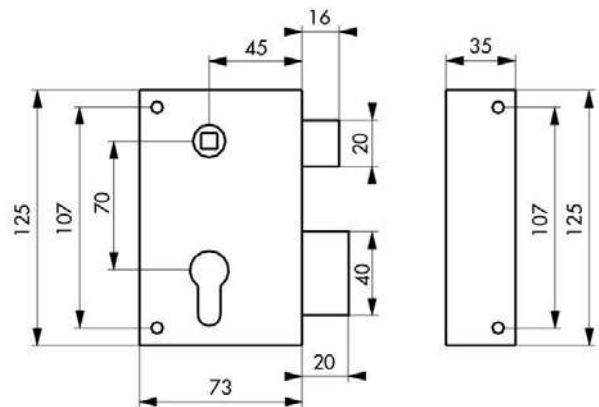

Description/Description/Descripción

Coffre et gâche inox 304 L cambré. Pêne et demi-tour laiton chromé. Mécanisme à 2 tours pêne 1/2 tour réversible pour porte ouvrant à l'extérieur. Carré 7 mm. Entrée de cylindre et de fouillot laiton chromé.

Cambered 304 L stainless steel case and striker. Chrome plated brass bolt and latch. Double latch mechanism. Reversible latch bolt for outside opening door. Square 7 mm. Chrome plated brass cylinder hole and follower plate.

Caja y cerradero de acero inoxidable 304 L curvado. Pestillo y media vuelta de latón cromado. Mecanismo de 2 vueltas. Pestillo media vuelta reversible para puerta con apertura hacia el exterior. Cuadrado 7 mm. Entrada de cilindro y de nuez de latón cromado.

Finition/Finish/Acabado

Inox brossé
Polished stainless steel
Epoxi negro granitado

Version/Option/Versión

Droite et gauche
Right and left hand
Derecha e izquierda

Designation	Boite	Colis.	Prix	Sachet	Colis.	Prix	Brochable					Colis.	Prix
							France	Euro 1	Euro 2	Euro 3	Euro 4		
BOITIER à cyl. profilé 73 x 125 mm droite	00072900	1	-	00972900	10	-	00372900	-	-	-	-	2	-
BOITIER à cyl. profilé 73 x 125 mm gauche	00072901	1	-	00972901	10	-	00372901	-	-	-	-	2	-

⚠ Non stocké/Non-stored/Producto no estocado - ☑ Sur stock Europe Zone 1 et Zone 2, nous consulter pour délai d'approvisionnement - ☒ Epuisement/Stock depletion/Agotamiento del stock

Serrure de grille et portail / A COMMANDE ELECTRIQUE

PROTECT



GARANTIE



X 3

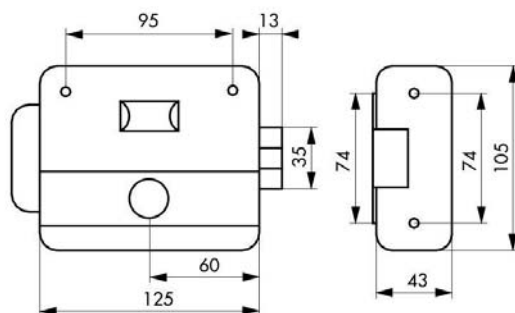

Description/Description/Descripción

Coffre et gâche acier embouté. Mécanisme réversible. Fonctionne avec courant basse tension. 12 volts. Cylindre à goupilles Ø 24 longueur 50 mm. Axe réglable de 50 à 70 mm. 3 clés nickelées. Accessoires : support de fixation, plots de contact. Conforme aux exigences de la directive européenne de compatibilité électromagnétique 89/336/CEE

Stamped steel case and striker. Reversible mechanism. Fitted with 12 V electric current. Pin cylinder Ø 24, 50 mm length. Adjustable backset from 50 to 70 mm. 3 nickel plated keys. Accessories : fitting holder, contactors. According to the european standard 89/336/CEE

Caja y cerradero de acero embutido. Mecanismo reversible. Funciona con corriente de baja tensión 12 voltios. Cilindro de pasadores Ø 24 longitud 50 mm. Eje regulable de 50 a 70 mm. 3 llaves niqueladas. Accesorios: soporte de fijación, plots de contacto. Conforme a las exigencias de la directiva europea de compatibilidad electromagnética 89/336/CEE

Finition/Finish/Acabado

Epoxy gris
Grey epoxy

Epoxi negro granitado

Version/Option/Versión

A double cylindre et bouton

Double cylinder and knob

De doble cilindro y botón



Designation	Boite	Colis.	Prix	Sachet	Colis.	Prix	Brochable					Colis.	Prix
							France	Euro 1	Euro 2	Euro 3	Euro 4		
SERRURE de SURETE à DC 50 mm révers. 3 clés	00005005	1	-	-	-	-	00505005	00593236 NS	00592236 NS	-	-	2	-
PLOTS de contact nylon pour serrure électrique	00006360	1	-	-	-	-	00106360	-	-	-	-	10	-

NS Non stocké/Non-stored/Producto no estocado - Sur stock Europe Zone 1 et Zone 2, nous consulter pour délai d'approvisionnement - E Epuisement/Stock depletion/Agotamiento del stock

Serrure de grille et portail / A COMBINAISON

PROTECT



GARANTIE

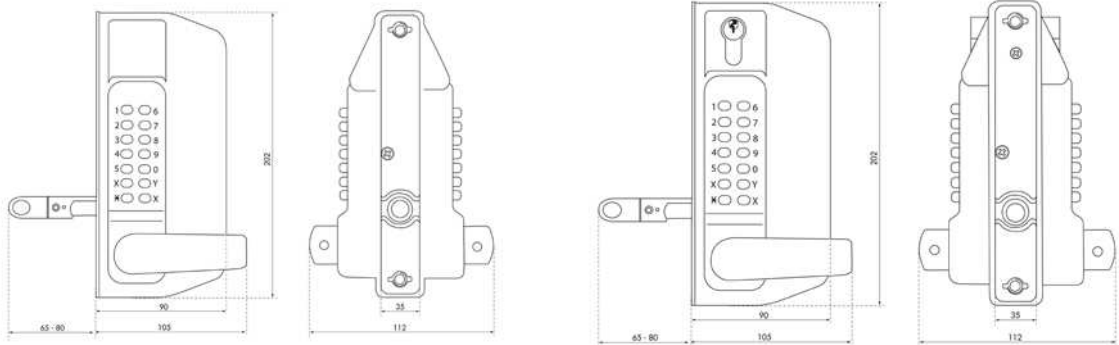

Description/Description/Descripción

Mécanisme à combinaison. Modirapide de la combinaison sans démontage de la serrure. Réversible.

Combination mechanism. Easy duty to change combination without dismantling the lock. Reversible. Mecanismo con combinación. Modide la combinación rapida sin desmantelar. Reversible.

Finition/Finish/Acabado

Laqué noir.

Black lacquered.

Lacado negro.

Version/Option/Versión

combinaison et cylindre pro

Combination and procyliner.

Combinació y cilindro perlado.

Designation	Boite	Colis.	Prix	Sachet	Colis.	Prix	Brochable					Colis.	Prix
							France	Euro 1	Euro 2	Euro 3	Euro 4		
SERRURE de grille/portail à combinaison	00005007	1	-	-	-	-	00505007	-	-	-	-	1	-
SERRURE de grille/portail à combinaison	00005008	1	-	-	-	-	00505008	-	-	-	-	1	-

⚠ Non stocké/Non-stored/Producto no estocado - 📦 Sur stock Europe Zone 1 et Zone 2, nous consulter pour délai d'approvisionnement - 📦 Epuisement/Stock depletion/Agotamiento del stock

Serrure POUR RIDEAU METALLIQUE ECO



GARANTIE



X 2

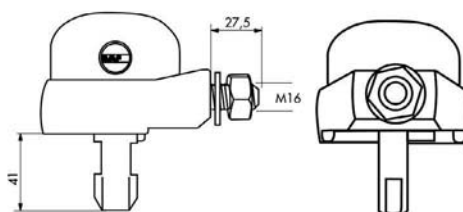
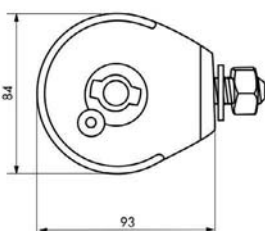
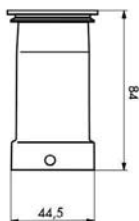

Description/Description/Descripción

Corps acier moulé. Cylindre de sécurité à goupilles avec protection de cloche contre le perçage. Corps interne en laiton massif. Ancrage en acier moulé. Cône d'attaque au sol en bronze avec couvercle à ressort. 2 clés.

Moulded steel body. Cylinder safety pins with bell protection against drilling. Internal solid brass body. Steel casting Docking. Cone ground attack bronze with spring cover. 2 keys.

Cuerpo de acero moldeado. Cilindro de seguridad con pasadores con protección de campana anti perforación. Cuerpo interno de latón macizo. Anclaje en acero fundido. Cono de anclaje al suelo de bronce con tapa a muelle. 2 llaves.

Finition/Finish/Acabado

Epoxy noir granité
Granited black epoxy
Epoxi negro granitado

Utilisation/Use/Utilización

Porte rideau métallique
Metal rolling shutter
Puertas verja metálica

Designation	Boîte	Colis.	Prix	Sachet	Colis.	Prix	Brochable					Colis.	Prix
							France	Euro 1	Euro 2	Euro 3	Euro 4		
SERRURE de fermeture pour rideau métallique	00013903	1	-	-	-	-	-	-	-	-	-	-	-

Non stocké/Non-stored/Producto no estocado - Sur stock Europe Zone 1 et Zone 2, nous consulter pour délai d'approvisionnement - Epuement/Stock depletion/Agotamiento del stock

Serrure rideau métallique / A CYLINDRE

ECO

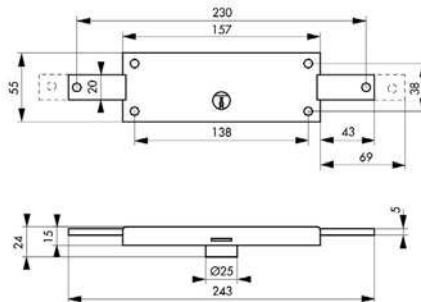

GARANTIE



X 3

Description/Description/Descripción

Coffre acier cambré. 2 points de condamnation latéraux.
Mécanisme pêne dormant. 3 clés laiton nickelé.

Cambered steel case. 2 lateral locking points. Bolt mechanism. 3 nickel brass plated keys.

Caja de acero curvado. 2 puntos de condenación laterales. Mecanismo de pestillo durmiente. 3 llaves de latón niqueladas.

Finition/Finish/Acabado

Zingué

Zinc plated

Cincado

Version/Option/Versión

S'entrouvrant (sur demande)

Keyed alike (on request).

Misma llave (a petición).

Utilisation/Use/Utilización

Porte rideau métallique

Metal rolling shutter

Puertas verja metálica

Designation	Boite	Colis.	Prix	Sachet	Colis.	Prix	Brochable				Colis.	Prix	
							France	Euro 1	Euro 2	Euro 3			Euro 4
SERRURE DE SURETE à cylindre Ø 25 mm pour rideau métallique	00001985	5	-	00901985	10	-	00401985	-	-	00494594	-	10	-

Serrure rideau métallique / POUR CYLINDRE

ECO

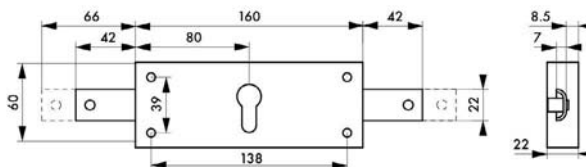

GARANTIE

Description/Description/Descripción

Coffre acier cambré. 2 points de condamnation latéraux.
Mécanisme pêne dormant.

Cambered steel case. 2 lateral locking points. Bolt mechanism.

Caja de acero curvado. 2 puntos de condenación laterales. Mecanismo de pestillo durmiente.

Finition/Finish/Acabado

Zingué / Zinc plated / Cincado

Utilisation/Use/Utilización

Porte rideau métallique

Metal rolling shutter

Puertas verja metálica

Designation	Boite	Colis.	Prix	Sachet	Colis.	Prix	Brochable				Colis.	Prix	
							France	Euro 1	Euro 2	Euro 3			Euro 4
BOITIER serrure horizontale à cylindre pour rideau métallique 2 points latéraux	00091997	5	-	00991997	10	-	00491997	-	-	00494997	-	10	-

⚠ Non stocké/Non-stored/Producto no estocado - 📦 Sur stock Europe Zone 1 et Zone 2, nous consulter pour délai d'approvisionnement - 🇪🇺 Epuisement/Stock depletion/Agotamiento del stock

Serrure A PLASTRON

ECO

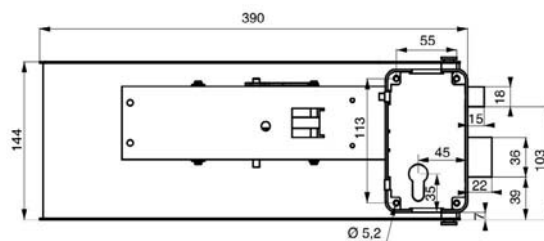
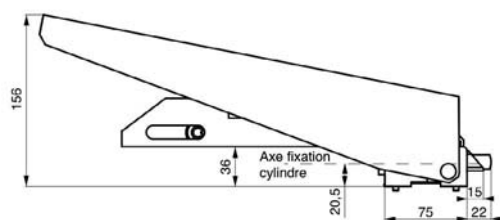
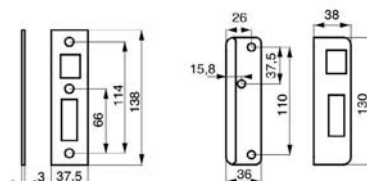

Description/Description/Descripción

Coffre en acier zingué embouti. Pêne et demi-tour en acier zingué. Mécanisme à 2 tours. Rappel du 1/2 tour par la clé. Déverrouillage du pêne et du demi-tour. Gâche laquée noire emboutie et gâche plate zinguée. Verrouillage 2 tours côté extérieur par clé. Déverrouillage d'urgence côté intérieur. (plastron actionnant pêne et 1/2 tour). Pour cylindre profilé européen 30 x 65 mm, pour porte de 40 mm.

Zinc plated pressed steel case. Zinc plated bolt and latch. Double latch mechanism. Drawback of the latch by the key. Unlocking of the bolt and latch. Black lacquered pressed striker and zinc plated flat striker. 2-latch locking outside with the key. Emergency unlocking inside. (plastron operating the bolt and the latch). For europrofile cylinders 30x65mm, for 40mm doors.

Caja de acero zincado embutido. Pestillo y media vuelta de acero zincado. Mecanismo de 2 vueltas. Reposición de la media vuelta con la llave. Desbloqueo del pestillo y de la media vuelta. Cerradero lacado negro embutido y cerradero plano zincado. Bloqueo de las 2 vueltas en el lado exterior con la llave. Desbloqueo de emergencia en el lado interior. (plastrón accionando pestillo y media vuelta). Para cilindro con perfil europeo 30x65mm por una puerta de 40mm

Finition/Finish/Acabado

Mécanisme zingué, epoxy rouge pour le plastron
Zinc plated mechanism, red epoxy finish for the plastron
Mecanismo zincado, plastrón rojo epoxy

Version/Option/Versión

Droite et gauche poussant. Axe 45 mm.
Right and left «pushing» version. Axis 45mm.
Derecha e izquierda versión «empujar». Eje a 45mm.

Utilisation/Use/Utilización

Montage en poussant sur porte bois ou tôle
Assembling on wooden door or metal sheet in «pushing» version
Montaje sobre puertas de madera o metálicas para la versión «empujar»



Designation	Boite	Colis.	Prix	Sachet	Colis.	Prix	Brochable					Colis.	Prix
							France	Euro 1	Euro 2	Euro 3	Euro 4		
Serrure à plastron boîtier CP droite	00012904	1	-	-	-	-	-	-	-	-	-	-	-
Serrure à plastron boîtier CP gauche	00012914	1	-	-	-	-	-	-	-	-	-	-	-

Serrure ANTIPANIQUE / D-CROSS

PROTECT



GARANTIE

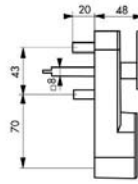
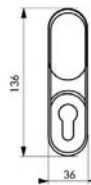
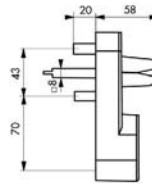
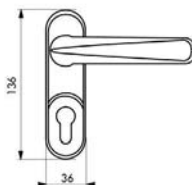
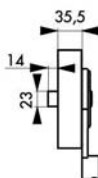
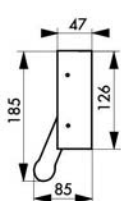

Ce produit porte le marquage CE (selon des critères de la norme NF EN 1125), il répond aux caractéristiques demandées concernant la sécurité des personnes.



EN 1125:2008
Classification

3 7 7 B 1 4 2 2 A A



Description/Description/Descripción

Structure, dimensions et performances conformes à la nouvelle norme européenne CE NF EN1125. Pêne acier zingué. Boîtier acier laqué. Barre aluminium longueur 1,15 m, recoupable. Réversible. Pour porte hauteur maxi 2 35 mm. Accessoires : béquille ou bouton de manœuvre extérieure, 1/2 cylindre profilé 30 x 10 mm.

Construction, measuring and performance are all in compliance with new european standard CE NF EN1125. Zinc coated steel bolt. Lacquered steel case. Aluminium steel bar length 1,15 m, can be shortened. Reversible. Height maxi 2635 mm. Accessories : Outside handle or knob, 1/2 profile cylinder 30 x 10 mm.

Estructura, dimensiones y prestaciones conformes a la nueva norma europea CE NF EN1125. Pestillo de acero cincado. Caja de acero lacado. Barra de aluminio con una longitud de 1,15 m, puede acortarse. Reversible. Altura maxi 2635 mm. Accesorios : tirador o botón de maniobra exterior, cilindro de 30 x 10 mm.

Finition/Finish/Acabado

Laqué noir, laqué blanc ou laqué gris

Black, white or grey lacquered

Lacado negro, lacado blanco o lacado gris

Version/Option/Versión

1 ou 2/3 points

1 point or 2/3 points

1 puntos, 2/3 puntos

Utilisation/Use/Utilización

Ouverture de secours anti panique pour tous types de portes.

Panic exit device for all types of door.

Apertura de emergencia antipánico para todo tipo de puertas.

Serrure ANTIPANIQUE / D-CROSS

PROTECT



Designation	Boite	Colis.	Prix	Sachet	Colis.	Prix	Brochable					Colis.	Prix
							France	Euro 1	Euro 2	Euro 3	Euro 4		
SERRURE ANTIPANIQUE 1 point latéral réversible laqué noir porte maxi 1150 mm	00009501 NS	1	-	-	-	-	-	-	-	-	-	-	-
SERRURE ANTIPANIQUE 1 point latéral réversible laqué blanc porte maxi 1150 mm	00009511	1	-	-	-	-	-	-	-	-	-	-	-
SERRURE ANTIPANIQUE 1 point latéral réversible laqué gris porte maxi 1150 mm	00009521	1	-	-	-	-	-	-	-	-	-	-	-
SERRURE ANTIPANIQUE 2/3 points haut et bas réversible laqué noir porte maxi 1150 mm	00009531	1	-	-	-	-	-	-	-	-	-	-	-
SERRURE ANTIPANIQUE 2/3 points haut et bas réversible laqué blanc porte maxi 1150 mm	00009541	1	-	-	-	-	-	-	-	-	-	-	-
SERRURE ANTIPANIQUE 2/3 points haut et bas réversible laqué gris porte maxi 1150 mm	00009551	1	-	-	-	-	-	-	-	-	-	-	-
POIGNEE DE MANŒUVRE EXTERIEURE laqué blanc - sans cylindre profilé	00009509	1	-	-	-	-	-	-	-	-	-	-	-
POIGNEE DE MANŒUVRE EXTERIEURE laqué gris - sans cylindre profilé	00009507	1	-	-	-	-	-	-	-	-	-	-	-
BOUTON DE MANŒUVRE EXTERIEUR laqué noir - sans cylindre profilé	00009504	1	-	-	-	-	-	-	-	-	-	-	-
BOUTON DE MANŒUVRE EXTERIEUR laqué blanc - sans cylindre profilé	00009505	1	-	-	-	-	-	-	-	-	-	-	-
BOUTON DE MANŒUVRE EXTERIEUR laqué gris - sans cylindre profilé	00009506	1	-	-	-	-	-	-	-	-	-	-	-
POIGNEE DE MANŒUVRE EXTERIEURE laqué noir - sans cylindre profilé	00009510	1	-	-	-	-	-	-	-	-	-	-	-
CYLINDRE PROFILE HG 30 x 10 mm 3 clés laiton panneton orientable	00053010	10	-	-	-	-	-	-	-	-	-	-	-
1/2 CYLINDRE 30 x10 mm nickelé panneton orientable 4 clés	00018739	1	-	-	-	-	-	-	-	-	-	-	-
CYLINDRE PROFILE COBRA2 31 x 10 mm 4 clés	00040331 NS	1	-	-	-	-	-	-	-	-	-	-	-
KIT RALLONGE haut - bas laqué noir pour porte hauteur 3,00 m maxi	00009512	1	-	-	-	-	-	-	-	-	-	-	-
KIT RALLONGE haut - bas laqué blanc pour porte hauteur 3,00 m maxi	00009513	1	-	-	-	-	-	-	-	-	-	-	-
KIT RALLONGE haut - bas laqué gris pour porte hauteur 3,00 m maxi	00009514	1	-	-	-	-	-	-	-	-	-	-	-

NS Non stocké/Non-stored/Productos no estocado - Sur stock Europe Zone 1 et Zone 2, nous consulter pour délai d'approvisionnement - E Epuement/Stock depletion/Agotamiento del stock



Serrure ANTIPANIQUE / S-PUSH

PROTECT



GARANTIE



Ce produit porte le marquage CE (selon des critères de la norme NF EN 1125), il répond aux caractéristiques demandées concernant la sécurité des personnes.



EN 1125:2008
Classification

3 7 7 B 1 4 2 2 A A



Description/Description/Descripción

Structure, dimensions et performances conformes à la nouvelle norme européenne CE NF EN11 2 . Pêne acier zingué. Boîtier acier laqué. Barre aluminium longueur 0,84 m, recoupable. Réversible. Pour porte hauteur maxi 2 35 mm. Accessoires : béquille ou bouton de manœuvre extérieure , 1/ 2 cylindre profilé 30 x 10 mm.

Construction, measuring and performance are all in compliance with new european standard CE NF EN1125. Zinc coated steel bolt. Lacquered steel case.

Aluminium steel bar length 0,84 m, can be shortened. Reversible. Height maxi 2635 mm. Accessories : Outside handle or knob, 1/2 profile cylinder 30 x 10 mm.

Estructura, dimensiones y prestaciones conformes a la nueva norma europea CE NF EN1125. Pestillo de acero cincado. Caja de acero lacado. Barra de aluminio con una longitud de 0,84 m, puede acortarse. Reversible. Altura maxi 2635 mm. Accesorios : tirador o botón de

maniobra exterior, cilindro de 30 x 10 mm.

Finition/Finish/Acabado

Laqué noir, laqué blanc ou laqué gris

Black, white or grey lacquered

Lacado negro, lacado blanco o lacado gris

Version/Option/Versión

1 ou 2/3 points

1 point or 2/3 points

1 puntos, 2/3 puntos

Utilisation/Use/Utilización

Ouverture de secours anti panique pour tous types de portes.

Panic exit device for all types of door.

Apertura de emergencia antipánico para todo tipo de puertas.

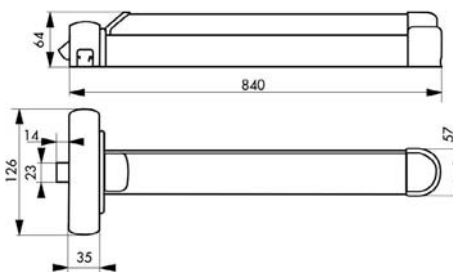

Serrure ANTIPANIQUE / S-PUSH

PROTECT



Designation	Boite	Colis.	Prix	Sachet	Colis.	Prix	Brochable					Colis.	Prix
							France	Euro 1	Euro 2	Euro 3	Euro 4		
SERRURE ANTIPANIQUE S-PUSH 1 point réversible laqué gris	00009581	1	-	-	-	-	-	-	-	-	-	-	-
SERRURE ANTIPANIQUE S-PUSH 1 point réversible laqué blanc	00009582	1	-	-	-	-	-	-	-	-	-	-	-
SERRURE ANTIPANIQUE S-PUSH 1 point réversible laqué noir	00009583	1	-	-	-	-	-	-	-	-	-	-	-
SERRURE ANTIPANIQUE S-PUSH 2/3 points haut et bas réversible laqué gris	00009584	1	-	-	-	-	-	-	-	-	-	-	-
SERRURE ANTIPANIQUE S-PUSH 2/3 points haut et bas réversible laqué blanc	00009585	1	-	-	-	-	-	-	-	-	-	-	-
SERRURE ANTIPANIQUE S-PUSH 2/3 points haut et bas réversible laqué noir	00009586	1	-	-	-	-	-	-	-	-	-	-	-
1/2 CYLINDRE 30 x10 mm nickelé panneton orientable 4 clés	00018739	1	-	-	-	-	-	-	-	-	-	-	-
CYLINDRE PROFILE COBRA2 31 x 10 mm 4 clés	00040331 <small>NS</small>	1	-	-	-	-	-	-	-	-	-	-	-
CYLINDRE PROFILE HG 30 x 10 mm 3 clés laiton panneton orientable	00053010	10	-	-	-	-	-	-	-	-	-	-	-
BOUTON DE MANŒUVRE EXTERIEUR laqué noir - sans cylindre profilé	00009504	1	-	-	-	-	-	-	-	-	-	-	-
BOUTON DE MANŒUVRE EXTERIEUR laqué blanc - sans cylindre profilé	00009505	1	-	-	-	-	-	-	-	-	-	-	-
BOUTON DE MANŒUVRE EXTERIEUR laqué gris - sans cylindre profilé	00009506	1	-	-	-	-	-	-	-	-	-	-	-
POIGNEE DE MANŒUVRE EXTERIEURE laqué gris - sans cylindre profilé	00009507	1	-	-	-	-	-	-	-	-	-	-	-
POIGNEE DE MANŒUVRE EXTERIEURE laqué blanc - sans cylindre profilé	00009509	1	-	-	-	-	-	-	-	-	-	-	-
POIGNEE DE MANŒUVRE EXTERIEURE laqué noir - sans cylindre profilé	00009510	1	-	-	-	-	-	-	-	-	-	-	-
KIT RALLONGE haut - bas laqué noir pour porte hauteur 3,00 m maxi	00009512	1	-	-	-	-	-	-	-	-	-	-	-
KIT RALLONGE haut - bas laqué blanc pour porte hauteur 3,00 m maxi	00009513	1	-	-	-	-	-	-	-	-	-	-	-
KIT RALLONGE haut - bas laqué gris pour porte hauteur 3,00 m maxi	00009514	1	-	-	-	-	-	-	-	-	-	-	-

NS Non stocké/Non-stored/Productos no estocado - SE Sur stock Europe Zone 1 et Zone 2, nous consulter pour délai d'approvisionnement - E Epuement/Stock depletion/Agotamiento del stock



Serrure ANTIPANIQUE / U-CROSS RESIST



GARANTIE

Interchangeable avec d'autres
modèles de serrure anti-panique

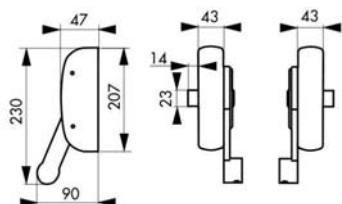

Ce produit porte le marquage CE (selon des critères de la norme NF EN 1125), il répond aux caractéristiques demandées concernant la sécurité des personnes.



Description/

Structure, dimensions et performances conformes à la nouvelle norme européenne CE NF EN11 2 . Pêne acier zingué. Boîtier acier laqué. Barre aluminium longueur 1,15 m, recoupable. Réversible. Pour porte hauteur maxi 2 35 mm. Accessoires : béquille ou bouton de manœuvre extérieure , 1/ 2 cylindre profilé 30 x 10 mm.

Finition/

Laqué noir, laqué blanc ou laqué gris

Version/

1 ou 3 points

Utilisation/

Ouverture de secours anti panique pour tous types de portes.



Designation	Boite	Colis.	Prix	Sachet	Colis.	Prix	Brochable					Colis.	Prix
							France	Euro 1	Euro 2	Euro 3	Euro 4		
SERRURE ANTIPANIQUE 1 point latéral réversible laqué noir porte maxi 1150 mm	00009601	1	-	-	-	-	-	-	-	-	-	-	-
SERRURE ANTIPANIQUE 1 point latéral réversible laqué blanc porte maxi 1150 mm	00009602	1	-	-	-	-	-	-	-	-	-	-	-
SERRURE ANTIPANIQUE 1 point latéral réversible laqué gris porte maxi 1150 mm	00009603	1	-	-	-	-	-	-	-	-	-	-	-
SERRURE ANTIPANIQUE 3 points haut et bas réversible laqué noir porte maxi 1150 mm	00009661	1	-	-	-	-	-	-	-	-	-	-	-
SERRURE ANTIPANIQUE 3 points haut et bas réversible laqué blanc porte maxi 1150 mm	00009662	1	-	-	-	-	-	-	-	-	-	-	-
SERRURE ANTIPANIQUE 3 points haut et bas réversible laqué gris porte maxi 1150 mm	00009663	1	-	-	-	-	-	-	-	-	-	-	-
POIGNEE DE MANŒUVRE EXTERIEURE laqué noir - sans cylindre profilé	00009510	1	-	-	-	-	-	-	-	-	-	-	-
POIGNEE DE MANŒUVRE EXTERIEURE laqué blanc - sans cylindre profilé	00009509	1	-	-	-	-	-	-	-	-	-	-	-
POIGNEE DE MANŒUVRE EXTERIEURE laqué gris - sans cylindre profilé	00009507	1	-	-	-	-	-	-	-	-	-	-	-
BOUTON DE MANŒUVRE EXTERIEUR laqué noir - sans cylindre profilé	00009504	1	-	-	-	-	-	-	-	-	-	-	-
BOUTON DE MANŒUVRE EXTERIEUR laqué blanc - sans cylindre profilé	00009505	1	-	-	-	-	-	-	-	-	-	-	-
BOUTON DE MANŒUVRE EXTERIEUR laqué gris - sans cylindre profilé	00009506	1	-	-	-	-	-	-	-	-	-	-	-
CYLINDRE PROFILE HG 30 x 10 mm 3 clés laiton panneton orientable	00053010	10	-	-	-	-	-	-	-	-	-	-	-
1/2 CYLINDRE 30 x10 mm nickelé panneton orientable 4 clés	00018739	1	-	-	-	-	-	-	-	-	-	-	-
CYLINDRE PROFILE COBRA2 31 x 10 mm 4 clés	00040331 NS	1	-	-	-	-	-	-	-	-	-	-	-
KIT RALLONGE haut - bas laqué noir pour porte hauteur 3,00 m maxi	00009512	1	-	-	-	-	-	-	-	-	-	-	-
KIT RALLONGE haut - bas laqué blanc pour porte hauteur 3,00 m maxi	00009513	1	-	-	-	-	-	-	-	-	-	-	-
KIT RALLONGE haut - bas laqué gris pour porte hauteur 3,00 m maxi	00009514	1	-	-	-	-	-	-	-	-	-	-	-

NS Non stocké/Non-stored/Productos no estocado - Sur stock Europe Zone 1 et Zone 2, nous consulter pour délai d'approvisionnement - E Epuement/Stock depletion/Agotamiento del stock





GARANTIE

Description/Description/Descripción

Crémone carénée. Design esthétique sans vis apparente. S'adapte sur différents supports bois, PVC, alu. Pose facile et rapide. Tringles réglables sans recoupe (système breveté). Réversible droite / gauche (système breveté sur version à béquille). Convient pour des hauteurs de porte jusqu'à 3000 mm maxi. Condamnation de l'intérieur à 1 tour par 1/2 cylindre profilé cylindre traversant ou 1/4 de tour par béquille. Pêne : Ø 14 mm, sortie de pêne 16 mm pour la version à béquille. Pêne : Ø 14 mm, sortie de pêne 2 mm pour la version à cylindre. Système de verrouillage anti intrusion (système breveté sur version à béquille). Dimensions : Crémone à béquille 38 x 2 x 2 00/3000 mm Boîtier crémone à cylindre 38 x 2 x 1600/ 2 00/3000 mm

Design, without visible screws. For wooden, PVC and aluminium doors. Easy and quick install - Adjustable rod. For door maxi 3000 mm height. One turn locking with profile cylinder, 1/4 turn locking with handle. Bolt Ø 14 mm, locking 16 mm for handle type - Bolt Ø 14 mm, locking 20 mm for cylinder type. Dimension : With handle 38 x 25 x 2300/3000 mm With Cylinder 38 x 25 x 1600/2300/3000 mm

Diseño, sin tornillo aparente. Para puerta de madera, PVC y aluminio. Instalación fácil y rápida - Barra regulable. Conviene para alturas de puerta hasta 3000 mm maxi. Condenación del interior de 1 vuelta por cilindro, o un 1/4 de vuelta por tirador. Pestillo Ø 14 mm, condenación de 16 mm para la versión con tirador. Dimensión : Con tirador 38 x 25 x 2300/3000 mm Con cilindro 38 x 25 x 1600/2300/3000 mm

Finition/Finish/Acabado

Blanc (RAL 9016), Argent (RAL 9006), Noir (RAL 9005)

White, silver, black

Blanco, plata, negro

Versión/Option/Versión

A béquille. Boîtier à cylindre profilé.

With handle. For profile cylinder

Con tirador. Con cilindro perfilado.

Utilisation/Use/Utilización

Porte et fenêtre

Door and window

Para puerta y ventana





Designation	Boite	Colis.	Prix	Brochable				Colis.	Prix
				France	Euro 1	Euro 2	Euro 3		
CRÉMONE 2 POINTS à béquille hauteur 2300 blanc	00061311 ☐	1	-	-	-	-	-	-	-
CRÉMONE 2 POINTS à béquille hauteur 2300 argent	00061313 ☐	1	-	-	-	-	-	-	-
CRÉMONE 2 POINTS à béquille hauteur 2300 noire	00061314	1	-	-	-	-	-	-	-
CRÉMONE 2 POINTS à béquille hauteur 3000 blanc	00061321	1	-	-	-	-	-	-	-
CRÉMONE 2 POINTS à béquille hauteur 3000 argent	00061323	1	-	-	-	-	-	-	-
BOITIER CRÉMONE 2 POINTS à cylindre profilé hauteur 1600 blanc	00061231 NS	1	-	-	-	-	-	-	-
BOITIER CRÉMONE 2 POINTS à cylindre profilé hauteur 1600 argent	00061233 NS	1	-	-	-	-	-	-	-
BOITIER CRÉMONE 2 POINTS à cylindre profilé hauteur 2300 blanc	00092436 E NS	1	-	-	-	-	-	-	-
BOITIER CRÉMONE 2 POINTS à cylindre profilé hauteur 2300 argent	00092437 NS	1	-	-	-	-	-	-	-
BOITIER CRÉMONE 2 POINTS à cylindre profilé hauteur 2300 noir	00061214	1	-	-	-	-	-	-	-
BOITIER CRÉMONE 2 POINTS à cylindre profilé hauteur 3000 blanc	00061221	1	-	-	-	-	-	-	-
BOITIER CRÉMONE 2 POINTS à cylindre profilé hauteur 3000 argent	00061223	1	-	-	-	-	-	-	-
Gâche haute pour serrure en poussant, blanche	00061001 NS	1	-	-	-	-	-	-	-
Gâche haute pour serrure en poussant, argent	00061003 NS	1	-	-	-	-	-	-	-
Gâche haute pour serrure en poussant, noire	00061004 NS	1	-	-	-	-	-	-	-
BOITIER CREMONE 2 points à cylindre profilé hauteur 2300 mm blanc - par 10 pièces	00071211 NS	10	-	-	-	-	-	-	-
BOITIER CREMONE 2 points à cylindre profilé hauteur 2300 mm argent- par 10 pièces	00071213 NS	10	-	-	-	-	-	-	-
BOITIER CREMONE 2 points à cylindre profilé hauteur 3000 mm blanc- par 10 pièces	00071221 NS	10	-	-	-	-	-	-	-
BOITIER CREMONE 2 points à cylindre profilé hauteur 3000 mm argent- par 10 pièces	00071223 NS	10	-	-	-	-	-	-	-
BOITIER CREMONE 2 points à cylindre profilé hauteur 1600 mm blanc- par 10 pièces	00071231 NS	10	-	-	-	-	-	-	-
BOITIER CREMONE 2 points à cylindre profilé hauteur 1600 mm argent- par 10 pièces	00071233 NS	10	-	-	-	-	-	-	-
SERRURE CREMONE 2 points à béquille hauteur 2300 mm blanc- par 10 pièces	00071311 NS	10	-	-	-	-	-	-	-
SERRURE CREMONE 2 points à béquille hauteur 2300 mm argent- par 10 pièces	00071313 NS	10	-	-	-	-	-	-	-
SERRURE CREMONE 2 points à béquille hauteur 3000 mm blanc- par 10 pièces	00071321 NS	10	-	-	-	-	-	-	-
SERRURE CREMONE 2 points à béquille hauteur 3000 mm argent- par 10 pièces	00071323 NS	10	-	-	-	-	-	-	-

NS Non stocké/Non-stored/Producto no estocado - ☐ Sur stock Europe Zone 1 et Zone 2, nous consulter pour délai d'approvisionnement - E Epuisement/Stock depletion/Agotamiento del stock



Crémone / SLIM CF

PROTECT

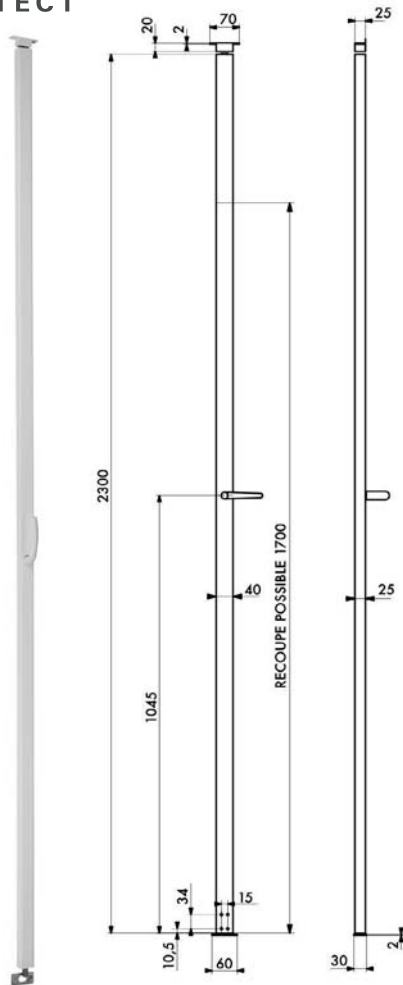

Objet d'un test de
résistance au feu E1 30
sur un bloc-porte de la
marque MALERBA



GARANTIE

Description/Description/Descripción

Crémone carénée à béquille. Design esthétique sans vis apparente. S'adapte sur différents supports bois, PVC, alu. Pose facile et rapide. Tringles réglables par tige filetée. Réversible droite / gauche. (système breveté). Convient pour des hauteurs de porte jusqu'à 3000 mm maxi. Condamnation de l'intérieur par quart de tour de béquille. Pêne : Ø 14 mm, sortie de pêne 16 mm. Système de verrouillage anti intrusion (système breveté). Livrée avec gâche haute pour serrure en poussant. Dimensions : 38 x 2 x 2 00/3000 mm

Design, without visible screws. For wooden, PVC and aluminium doors. Easy and quick install. Adjustable rod. For door maxi 3000 mm height. 1/4 turn locking with handle. Bolt Ø 14 mm, locking 16 mm. Dimension : 38 x 25 x 2300/3000 mm

Diseño, sin tornillo aparente. Para puerta de madera, PVC y aluminio. Instalación fácil y rápida. Barra regulable. Conviene para alturas de puerta hasta 3000 mm maxi. 1/4 de vuelta por tirador. Pestillo Ø 14 mm, condenación de 16 mm. Dimensión : 38 x 25 x 2300/3000 mm

Finition/Finish/Acabado

Blanc (RAL 9016), Argent (RAL 9006), Noir (RAL 9005)

White, silver, black

Blanco, plata, negro

Utilisation/Use/Utilización

Porte et fenêtre

Door and window

Para puerto y ventana

Designation	Boite	Colis.	Prix	Sachet	Colis.	Prix	Brochable					Colis.	Prix
							France	Euro 1	Euro 2	Euro 3	Euro 4		
CRÉMONE 2 PTS à béquille hauteur 2300 blanc, livrée en poussant	00062311 NS	1	-	-	-	-	-	-	-	-	-	-	-
CRÉMONE 2 PTS à béquille hauteur 2300 argent, livrée en poussant	00062313 NS	1	-	-	-	-	-	-	-	-	-	-	-
CRÉMONE 2 PTS à béquille hauteur 2300 noir, livrée en poussant	00062314 NS	1	-	-	-	-	-	-	-	-	-	-	-
CRÉMONE 2 PTS à béquille hauteur 3000 blanc, livrée en poussant	00062321 NS	1	-	-	-	-	-	-	-	-	-	-	-
CRÉMONE 2 PTS à béquille hauteur 3000 argent, livrée en poussant	00062323 NS	1	-	-	-	-	-	-	-	-	-	-	-
CRÉMONE 2 PTS à béquille hauteur 3000 noir, livrée en poussant	00062324 NS	1	-	-	-	-	-	-	-	-	-	-	-
Gâche haute pour serrure en poussant, blanche	00061001 NS	1	-	-	-	-	-	-	-	-	-	-	-
Gâche haute pour serrure en poussant, argent	00061003 NS	1	-	-	-	-	-	-	-	-	-	-	-
Gâche haute pour serrure en poussant, noire	00061004 NS	1	-	-	-	-	-	-	-	-	-	-	-

NS Non stocké/Non-stored/Producto no estocado - E Sur stock Europe Zone 1 et Zone 2, nous consulter pour délai d'approvisionnement - E Epusement/Stock depletion/Agotamiento del stock

Boîtier serrure / APPLIQUE CP PÊNE DORMANT ECO



GARANTIE

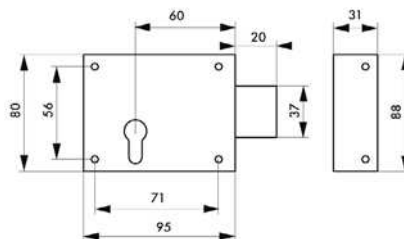

Description/Description/Descripción

Coffre en acier cambré galvanisé. Pêne dormant en acier zingué. Mécanisme à 2 tours. Livré sans gâche. Pour cylindre profilé européen. Réversible.

Raised galvanised steel case. Galvanised steel lock bolt. 2 turn mechanism. Without striker. For european profile cylinder. Reversible.

Caja de acero curvado cincado. Pestillo durmiente de acero cincado. Mecanismo de 2 vueltas. No cerradero. Para cilindro perfilado europeo. Reversible.

Finition/Finish/Acabado

Galvanisé
Galvanised
Galvanizado

Designation	Boîte	Colis.	Prix	Sachet	Colis.	Prix	Brochable					Colis.	Prix
							France	Euro 1	Euro 2	Euro 3	Euro 4		
Boîtier CP 95 x 80 mm galvanisé sans gâche	00099122	10	-	-	-	-	-	-	-	-	-	-	-

Boîtier serrure / APPLIQUE CP PÊNE DORMANT ECO



GARANTIE

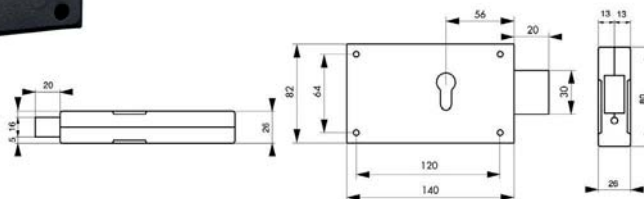

Description/Description/Descripción

Coffre en acier cambré zingué. Pêne dormant en acier zingué. Mécanisme à 2 tours. Livré avec ou sans gâche. Pour cylindre profilé européen (non fourni) 30 x 55 mm, pour porte de 45 mm. Réversible

Raised galvanised steel case. Galvanised steel lock bolt. 2 turn mechanism. Without striker. For european profile cylinder.

Caja de acero curvado cincado. Pestillo durmiente de acero cincado. Mecanismo de 2 vueltas. No cerradero. Para cilindro perfilado europeo.

Finition/Finish/Acabado

Epoxy noir granité
Granited black epoxy
Epoxi negro granitado

Designation	Boîte	Colis.	Prix	Sachet	Colis.	Prix	Brochable					Colis.	Prix
							France	Euro 1	Euro 2	Euro 3	Euro 4		
Boltier CP 140 x 80 mm sans gâche	00009770	1	-	-	-	-	-	-	-	-	-	-	-
Boltier CP 140 x 80 mm avec gâche	00009771	1	-	-	-	-	-	-	-	-	-	-	-

Non stocké/Non-stored/Producto no estocado - Sur stock Europe Zone 1 et Zone 2, nous consulter pour délai d'approvisionnement - Epuement/Stock depletion/Agotamiento del stock

Accessoires / GÂCHE A COMMANDE ELECTRIQUE

PROTECT

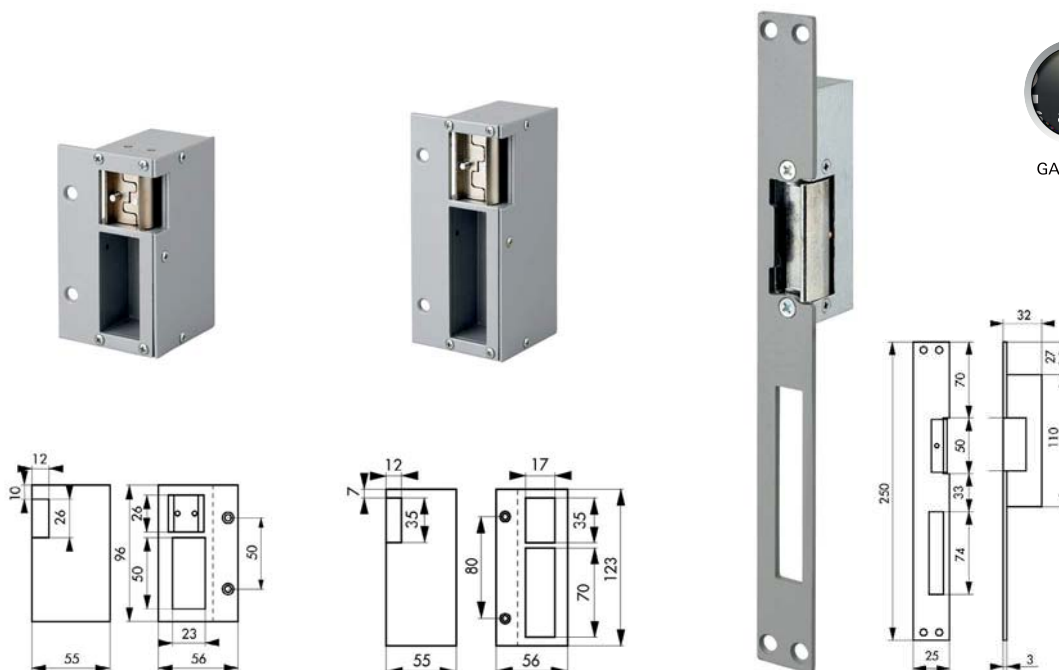

GARANTIE

Description/Description/Descripción

Corps alliage. Double empênege. Peut être posée à l'extérieur. Courant d'alimentation : continu 12 V ou alternatif à contact stationnaire (une seule impulsion électrique libère la gâche, qui reste déverrouillée jusqu'à ce que la porte soit manœuvrée. C'est l'ouverture de la porte qui re-verrouille la gâche en annulant l'effet du contact stationnaire). Réversible. Accessoires : transformateur 20 - 12 V, ressort de renvoi pour pose en feuillure 12 mm, ressort de renvoi escargot pour pose en applique. Conforme aux exigences de la directive européenne de compatibilité électromagnétique 89/336/CEE.

AlloyCase. For double bolt. Can be fitted outdoor. Continuous current 12 V or alternating. Reversible. Accessories : transformer 220-12 V, flat spring 12 mm, spring to be installed on frame. According to the european standard 89/336/CEE.

Cuerpo de aleación. Doble empestillado. Puede instalarse por el exterior. Corriente de alimentación: continua 12 V o alterna. Reversible. Accesorios: transformador 220 - 12 V, muelle de transmisión para montaje en rebaje 12 mm. Muelle de transmisión caracol para montaje en plastrón. Conforme a las exigencias de la directiva europea de compatibilidad electromagnética 89/336/CEE.

Finition/Finish/Acabado

Laqué gris
Grey lacquered
Lacado gris

Version/Option/Versión

Pour serrure horizontale, verticale ou à encastrer
For horizontal, vertical or mortise lock
Para cerradura horizontal, vertical o para empotrar.

Designation	Boite	Colis.	Prix	Sachet	Colis.	Prix	Brochable					Colis.	Prix
							France	Euro 1	Euro 2	Euro 3	Euro 4		
GACHE pour serrure horizontale réversible	00008850	1	-	-	-	-	00208850	00293237 NS	00292237 NS	00294237	-	2	-
GACHE pour serrure verticale réversible	00012050	1	-	-	-	-	00212050	00293238 NS	00292238 NS	00294238	-	2	-
GACHE pour serrure à mortaiser révers.	00024825	1	-	-	-	-	00424825	00493239 NS	00492239 NS	00494239	-	2	-
RESSORT de renvoi pour pose en feuillure 12 mm	00000050	10	-	-	-	-	00200050	-	-	-	-	10	-
RESSORT de renvoi escargot en applique	00000051	10	-	-	-	-	00100051	-	-	-	-	10	-
TRANSFORMATEUR 220 V - 12 V pour gâche	00000052	1	-	-	-	-	00100052	00193603	00192603 NS	00194603	-	5	-

NS Non stocké/Non-stored/Producto no estocado - S Sur stock Europe Zone 1 et Zone 2, nous consulter pour délai d'approvisionnement - E Epuisement/Stock depletion/Agotamiento del stock

Gâche / ÉLECTRIQUE À ENCASTRER

PROTECT



Connecteur électrique 100% inoxydable, soudure protégée intérieurement, nouveau système de mémoire.



GARANTIE

024826	024827	024828
12/24V. AC/DC	12/24V. AC/DC	12V. DC
A impulsion	A impulsion 2 temps	A rupture
-	Mémoire	-
Levier de déverrouillage	Levier de déverrouillage	-
12V.AC 258mA -12V.DC 229mA 24V.AC 516mA - 24V.DC 598mA		216 mA

Description/Description/Descripción

Corps alliage. Tête inox. Double empennage. Réversible et symétrique. Levier de déverrouillage (sauf ref.00024828). Rouleau réglable. Résistance à l'effraction : 300daN.

Alloy body, stainless steel forend. Reversible and symmetrical. Unlocking lever. Adjustable roller. 300daN resistance.

Cuerpo de aleación. Frontal inox. Doble oricio. Reversible y simétrica. Palanca de desbloqueo. Pestillo regulable. Resistencia a la rotura 300daN.

Finition/Finish/Acabado

Inox.

Stainless steel.

Acero inoxidable.

Version/Option/Versión

00024827 : avec mémoire - 00027828 : à rupture.

00024827 : with memory - 00024828 : with break

00024827 : con memoria - 00024828 : Inverso

Utilisation/Use/Utilización

Pour porte bois et métal.

For wooden and metal door

Para puertas de madera y metálicas.



Designation	Boite	Colis.	Prix	Brochable				Colis.	Prix
				France	Euro 1	Euro 2	Euro 3		
Gâche électrique à impulsion - réversible - 12/24V. AC/DC	00024826	1	-	-	-	-	-	-	-
Gâche électrique à impulsion 2 temps - réversible - 12/24V. AC/DC	00024827	1	-	-	-	-	-	-	-
Gâche électrique à rupture - réversible - 12V/DC	00024828	1	-	-	-	-	-	-	-

Non stocké/Non-stored/Producto no estocado - Sur stock Europe Zone 1 et Zone 2, nous consulter pour délai d'approvisionnement - Epuisement/Stock depletion/Agotamiento del stock

Gâche / ÉLECTRIQUE APPLIQUE

PROTECT



GARANTIE

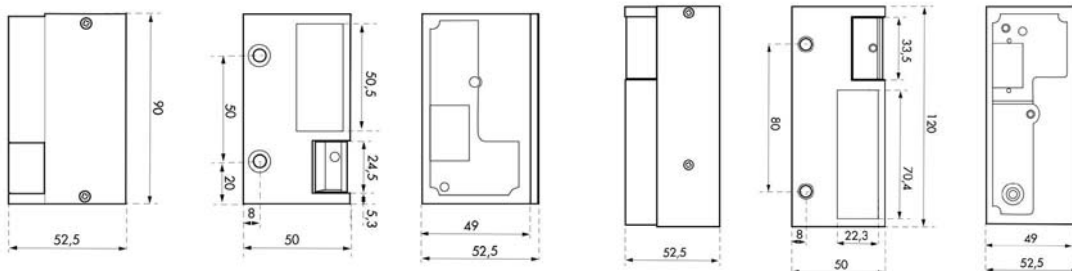

008851 / 008852	012051 / 012052
12/24V. AC/DC	12/24V. AC/DC
A émission avec mémoire	A émission avec mémoire
850mA	850mA

Description/Description/Descripción

Corps aluminium. Double empennage. Réversible. A 2 temps.

Alloy case. For double bolt. Reversible.

Cuerpo de aluminio. Doble oricio. Reversible. Con memoria.

Finition/Finish/Acabado

Laqué gris

Grey lacquered

Lacado gris

Version/Option/Versión

Droite et gauche.

Right and left.

Derecha y izquierda.

Utilisation/Use/Utilización

Pour serrure applique horizontale, verticale

For horizontal, vertical lock

Para cerradura horizontal, vertical

Designation	Boite	Colis.	Prix	Brochable				Colis.	Prix
				France	Euro 1	Euro 2	Euro 3		
Gâche électrique - 12-24V AC/DC - pour serrure horizontale - droite	00008851	1	-	-	-	-	-	-	-
Gâche électrique - 12-24V AC/DC - pour serrure horizontale - gauche	00008852	1	-	-	-	-	-	-	-
Gâche électrique - 12-24V AC/DC - pour serrure verticale - droite	00012051	1	-	-	-	-	-	-	-
Gâche électrique - 12-24V AC/DC - pour serrure verticale - gauche	00012052	1	-	-	-	-	-	-	-

⚠ Non stocké/Non-stored/Producto no estocado - 📦 Sur stock Europe Zone 1 et Zone 2, nous consulter pour délai d'approvisionnement - 📦 Epuisement/Stock depletion/Agotamiento del stock

Gâche / ÉLECTRIQUE APPLIQUE POUR ANTIPANIQUE

PROTECT



GARANTIE



Livrée avec 4 entretoises

008853	008854
12V. AC	12V. DC
A émission	A rupture
500mA	200mA

Description/Description/Descripción

Corps acier, réversible, livré avec 4 entretoises (épaisseur 1- 2 3-3mm).

Steel body, reversible, with 4 plates 1-2-3-3mm).

Cuerpo de acero, reversible, incluye 4 espaciadores (espesor 1-2-3-3mm).

Finition/Finish/Acabado

Laqué noir.

Black lacquered.

Lacado negro.

Version/Option/Versión

00008853 : standard, 500mA - 00008854 : à rupture, 200mA.

00008853 : standard, 500mA - 00008854 : with break

00008853 : estandar, 500mA - 00008854 : Inverso, 200mA.

Utilisation/Use/Utilización

Pour porte équipée d'une barre antipanique

For door with push bar

Para puertas equipadas de una barra anti pánico en la hoja activa



Designation	Boite	Colis.	Prix	Brochable				Colis.	Prix
				France	Euro 1	Euro 2	Euro 3		
Gâche électrique à émission - réversible - 12V AC - pour serrure antipanique	00008853	1	-	-	-	-	-	-	-
Gâche électrique à rupture - réversible - 12V DC - pour serrure antipanique	00008854	1	-	-	-	-	-	-	-

⚠ Non stocké/Non-stored/Producto no estocado - 📦 Sur stock Europe Zone 1 et Zone 2, nous consulter pour délai d'approvisionnement - ⚠ Epuisement/Stock depletion/Agotamiento del stock

Accessoires / GAÎNE PASSE-CÂBLE PROTECT

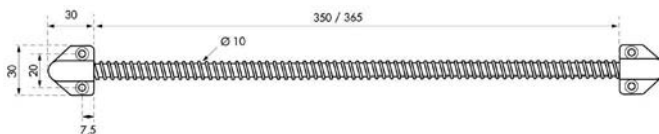

GARANTIE

Description/Description/Descripción

Support plastique. Gaine inox, pour câble diam. 4,5mm maxi.

Plastic support. Stainless steel sheath, for cable diam. 4,5 max.

Soporte de plástico. Vaina inox, para cable di 4,5 máx.

Finition/Finish/Acabado

Inox.

Stainless steel.

Inox

Utilisation/Use/Utilización

Gaine de protection pour passage de câble de serrure électrique, gâche ...

Protective sheath for electric lock, strike.

Vaina de protección para el paso de cable de cerradura eléctrica, cierre...

Designation	Boite	Colis.	Prix	Sachet	Colis.	Prix	Brochable					Colis.	Prix
							France	Euro 1	Euro 2	Euro 3	Euro 4		
Gaine électrique passe-câble 290mm	00000053	1	-	-	-	-	-	-	-	-	-	-	-

Accessoires / TRANSMETTEUR DE COURANT PROTECT

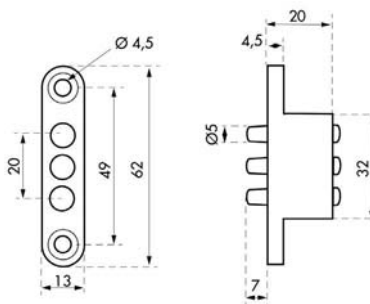

GARANTIE

Description/Description/Descripción

ABS. 3 plots, 2 V AC/DC - 2

ABS. 3

ABS. 3 contactos, 24V AC/DC - 2A.

Finition/Finish/Acabado

ABS noir.

Black ABS

Abs negro

Utilisation/Use/Utilización

Transmetteur pour l'établissement du courant entre la partie fixe et la partie mobile, dans le cadre d'une installation avec gâche électrique

Transmitter for establishing the current between the fixed and moving part in an installation with an electric strike
Contactos para permitir el paso de corriente de la parte fija a la parte móvil, para instalaciones con cierres eléctricos.

Designation	Boite	Colis.	Prix	Sachet	Colis.	Prix	Brochable					Colis.	Prix
							France	Euro 1	Euro 2	Euro 3	Euro 4		
Transmetteur de courant - 3 plots - 24V AC/DC - 2A	00000054	1	-	-	-	-	-	-	-	-	-	-	-

⚠ Non stocké/Non-stored/Producto no estocado - 📦 Sur stock Europe Zone 1 et Zone 2, nous consulter pour délai d'approvisionnement - 📦 Epuisement/Stock depletion/Agotamiento del stock

Accessoires / ENTREES, ROSACES

ECO



GARANTIE

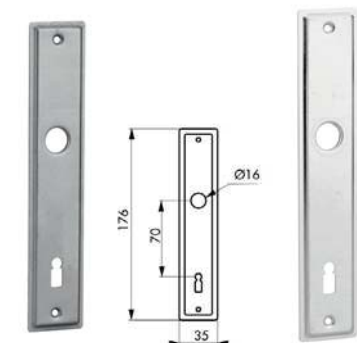

00030333

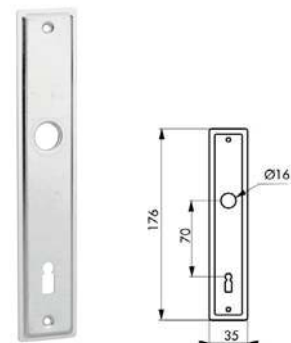

00000576



00041264

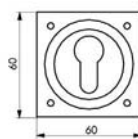

00082900

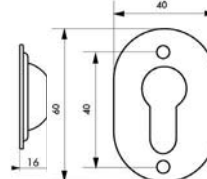

Description/Description/Descripción

Pour serrure à encastrer. Pour serrure en applique verticale. Pour cylindre profilé. Pour cylindre Ø 2 mm. Pour cylindre Ø 30 mm.

Mortise lock. Vertical lock. For profile cylinder. For Ø 23 mm cylinder. For Ø 30 mm cylinder.

Para cerradura a empotrar. Para cerradura en plastrón vertical. Para cilindro perfilado. Para cilindro Ø 23 mm. Para cilindro Ø 30 mm.

Designation	Boite	Colis.	Prix	Sachet	Colis.	Prix	Brochable					Colis.	Prix
							France	Euro 1	Euro 2	Euro 3	Euro 4		
ENTREE acier pour serrure à larder	00000575	10	-	-	-	-	-	-	-	-	-	-	-
ENTREE alu pour serrure à larder	00000576	10	-	-	-	-	-	-	-	-	-	-	-
ENTREE acier trou de cylindre profilé	00030333	10	-	-	-	-	-	-	-	-	-	-	-
ENTREE acier Ø 23 mm	00030334	10	-	-	-	-	-	-	-	-	-	-	-
ENTREE laiton Ø 30 mm	00030335	10	-	-	-	-	-	-	-	-	-	-	-
ROSACE laiton Ø 23 mm	00030331	10	-	-	-	-	-	-	-	-	-	-	-
ROSACE laiton Ø 30 mm	00030332	10	-	-	-	-	-	-	-	-	-	-	-
ROSACE laitonée pour cylindre profilé	00082900	10	-	-	-	-	00182900	-	-	-	-	10	-
ENTREE à cuvette laiton 60 x 60 mm pour serrure trou de clé	00041262	10	-	-	-	-	00141262	-	-	-	-	10	-
ENTREE à cuvette laiton chromé 60 x 60 mm pour serrure trou de clé	00041263	10	-	-	-	-	00141263	-	-	-	-	10	-
ENTREE à cuvette laiton 60 x 60 mm trou de cylindre profilé	00041264	10	-	00941264	30	-	00141264	-	-	-	-	10	-
ENTREE à cuvette chromé 60 x 60 mm trou de cylindre profilé	00041265	10	-	00941265	30	-	00141265	-	-	-	-	10	-

Non stocké/Non-stored/Productos no estocados - Sur stock Europe Zone 1 et Zone 2, nous consulter pour délai d'approvisionnement - Epuement/Stock depletion/Agotamiento del stock

SUPPLÉMENTS POUR SERRURES EN APPLIQUE ET TUBULAIRES

Designation	Boite	Colis.	Prix	Sachet	Colis.	Prix	Brochable					Colis.	Prix
							France	Euro 1	Euro 2	Euro 3	Euro 4		
GÂCHE SEULE pour serrure verticale droite et gauche	-	-	-	00900631	10	-	00200631	-	-	-	-	10	-
GÂCHE SEULE pour serrure horizontale droite et gauche	-	-	-	00900611	10	-	00100611	-	-	-	-	10	-
GÂCHE avec tête pour serrure de portail réversible	000019231	10	-	-	-	-	-	-	-	-	-	-	-
LUBRIFIANT poudre graphite 95 ml pour cylindre	000096005	10	-	00996005	10	-	00296005	-	-	-	-	10	-
PRESENTOIR de 20 burettes LUBRIFIANT poudre graphite 95 ml pour cylindre	000096205	1	-	-	-	-	-	-	-	-	-	-	-
PLAQUE DE FIXATION à souder pour serrure horizontale Z	00007967	10	-	-	-	-	-	-	-	-	-	-	-
PLAQUE DE FIXATION à souder pour serrure verticale Z	00008967	10	-	-	-	-	-	-	-	-	-	-	-
Supplément pour numéro imposé (pour quantité < 50 pièces)	-	-	-	-	-	-	00010116	-	-	-	-	-	-



Serrures de meubles

ECO
PROTECT
RESIST

SERRURE POUR MEUBLE



Serrure de vitrine coulissante		904
Serrure en applique		904
Serrure à cylindre		905
Serrure à pattes		906
Serrure en applique		906
Serrure «Façon Paris»		907
Boîtier de serrure universelle		908
Loqueteau à bille		908
Loqueteau magnétique		909
Loqueteau à crochet		909



Serrure pour VITRINE COULISSANTE ECO

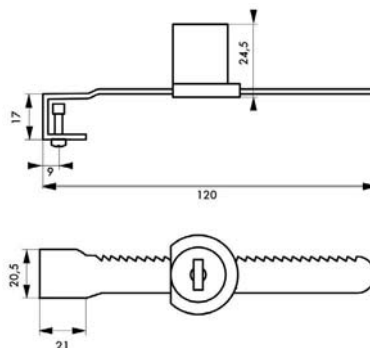

GARANTIE



X 2

Description/Description/Descripción

Crémaillère acier. Cylindre à paillettes. 2 clés nickelées gainées PVC.

Steel rack. Disc-tumblers cylinder. 2 nickel plated keys with head protector by a PVC shell.

Steel rack. Disc-tumblers cylinder. 2 nickel plated keys with head protector by a PVC shell.

Finition/Finish/Acabado

Nickelé

Nickel plated

Niquelado

Utilisation/Use/Utilización

Vitrine à porte coulissante

Window-case sliding door

Vitrina con puerta corredera

Designation	Boite	Colis.	Prix	Sachet	Colis.	Prix	Brochable					Colis.	Prix
							France	Euro 1	Euro 2	Euro 3	Euro 4		
Serrure pour vitrine coulissante	-	-	-	00904190	25	-	00104190	00193727 NS	00192727 NS	-	-	10	-

Serrures pour meubles / EN APPLIQUE ECO

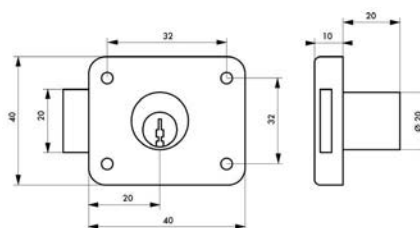

GARANTIE



X 2

Description/Description/Descripción

Corps alliage moulé. Cylindre à paillettes. Pose à droite ou à gauche. 2 clés nickelées.

Moulded alloy case. Disc-tumblers cylinder. Right or left operating. 2 nickel plated keys.

Cuerpo de aleación moldeada. Cilindro de plaquitas. Montaje a la derecha o a la izquierda. 2 llaves niqueladas.

Finition/Finish/Acabado

Nickelé

Nickel plated

Niquelado

Utilisation/Use/Utilización

Porte d'ameublement

Furnishing door

Puerta de muebles

Designation	Boite	Colis.	Prix	Sachet	Colis.	Prix	Brochable					Colis.	Prix
							France	Euro 1	Euro 2	Euro 3	Euro 4		
Serrure en applique longueur 20 mm	-	-	-	00902402	25	-	00102402	00193726 NS	00192726 NS	00194726	-	10	-

NS Non stocké/Non-stored/Producto no estocado - ☑ Sur stock Europe Zone 1 et Zone 2, nous consulter pour délai d'approvisionnement - E Epuisement/Stock depletion/Agotamiento del stock

Serrures pour meubles / A CYLINDRE

ECO



GARANTIE



X 3



	50 mm	60 mm	70 mm
A	50	60	70
B	52	52	55
C	25	35	40
D	35	42	55

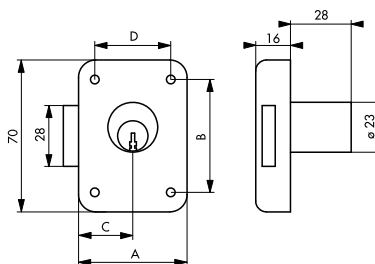

Description/Description/Descripción

Coffre et pêne acier. Cylindre laiton. à 5 goupilles. 3 clés acier nickelé.

Steel case and bolt. 5 pin brass cylinder. 3 nickel plated keys

Caja y pestillo de acero. Cilindro de latón de 5 pasadores. 3 llaves de acero niquelado.

Finition/Finish/Acabado

Epoxy noir granité

Black epoxy

Epoxi negro granitado

Version/Option/Versión

Droite et gauche

Right and left hand

Derecha e izquierda

Utilisation/Use/Utilización

Porte d'ameublement

Furnishing door

Puerta de muebles



Designation	Boite	Colis.	Prix	Sachet	Colis.	Prix	Brochable					Colis.	Prix
							France	Euro 1	Euro 2	Euro 3	Euro 4		
Serr. de sûreté 50 mm axe 25 mm drte	00014750	5	-	-	-	-	-	-	-	-	-	-	-
Serr. de sûreté 50 mm axe 25 mm gche	00014751	5	-	-	-	-	-	-	-	-	-	-	-
Serr. de sûreté 60 mm axe 35 mm drte	00014760	5	-	-	-	-	-	-	-	-	-	-	-
Serr. de sûreté 60 mm axe 35 mm gche	00014761	5	-	-	-	-	-	-	-	-	-	-	-
Serr. de sûreté 70 mm axe 40 mm drte	00014770	5	-	-	-	-	-	-	-	-	-	-	-
Serr. de sûreté 70 mm axe 40 mm gche	00014771	5	-	-	-	-	-	-	-	-	-	-	-

Non stocké/Non-stored/Producto no estocado - Sur stock Europe Zone 1 et Zone 2, nous consulter pour délai d'approvisionnement - Epuisement/Stock depletion/Agotamiento del stock

Serrures pour meubles / A PATTES

ECO



	30 mm	40 mm	50 mm
A	30	40	50
B	50	50	60
C	15	20	25
D	22	28	32
E	60	60	68

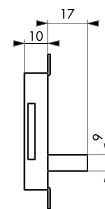
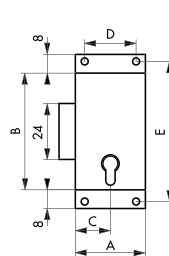

GARANTIE



X 1

Description/Description/Descripción

Coffre et pêne acier. Pose à droite ou à gauche. 1 clé laitonée vieillie.

Steel case and bolt. Right or left fitting. 1 antique brass key.

Caja y pestillo de acero. Montaje a la derecha o a la izquierda. 1 llave latonada envejecida.

Finition/Finish/Acabado

Acier laitoné ou zingué

Brass or zinc plated steel

Acero latonado o cincado

Utilisation/Use/Utilización

Porte d'ameublement

Furnishing door

Puerta de muebles

Designation	Boite	Colis.	Prix	Sachet	Colis.	Prix	Brochable					Colis.	Prix
							France	Euro 1	Euro 2	Euro 3	Euro 4		
Serrures à pattes acier zingué 30 mm	-	-	-	00900232	25	-	00100232	-	-	-	-	10	-
Serrures à pattes acier zingué 40 mm	-	-	-	00900242	25	-	00100242	-	-	-	-	10	-
Serrures à pattes acier zingué 50 mm	-	-	-	00900252	25	-	00100252	-	-	-	-	10	-
Serrures à pattes laitonée 30 mm	-	-	-	-	-	-	00100231	-	-	-	-	10	-
Serrures à pattes laitonée 40 mm	-	-	-	-	-	-	00100241	-	-	-	-	10	-
Serrures à pattes laitonée 50 mm	-	-	-	-	-	-	00100251	-	-	-	-	10	-

Serrure pour meubles / EN APPLIQUE

ECO

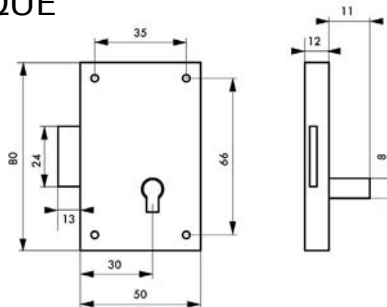

GARANTIE



X 1

Description/Description/Descripción

Coffre et pêne acier. Mécanisme à 2 tours. Pose à droite. 1 clé laitonée vieillie.

Steel case and bolt. Twice turning lock mechanism. Right hand. 1 antique brass key.

Caja y pestillo de acero. Mecanismo de 2 vueltas. Montaje a la derecha. 1 llave latonada envejecida.

Finition/Finish/Acabado

Acier poli

Polished steel

Acero pulido

Utilisation/Use/Utilización

Porte d'ameublement

Furnishing door

Puerta de muebles

Designation	Boite	Colis.	Prix	Sachet	Colis.	Prix	Brochable					Colis.	Prix
							France	Euro 1	Euro 2	Euro 3	Euro 4		
Serrure acier poli 50 mm droite	-	-	-	00900352	25	-	00100352	-	-	-	-	10	-

Serrure pour meubles / «FACON PARIS»

ECO



GARANTIE



X 1



	50 mm	55 mm	60 mm	65 mm
A	50	55	60	65
B	25	30	35	40
C	33	38	43	48

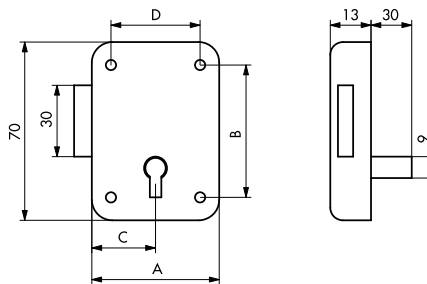

Description/Description/Descripción

Coffre et pêne acier. 1 clé nickelée
Steel case and bolt. 1 nickel plated key
Caja y pestillo de acero. 1 llave niquelada

Finition/Finish/Acabado

Epoxy gris granité
Grey epoxy
Epoxi gris granitado

Version/Option/Versión

Droite et gauche
Right and left hand
Derecha e izquierda

Utilisation/Use/Utilización

Porte d'ameublement
Furnishing door
Puerta de muebles

Designation	Boite	Colis.	Prix	Sachet	Colis.	Prix	Brochable					Colis.	Prix
							France	Euro 1	Euro 2	Euro 3	Euro 4		
Serrure 50 mm axe 25 mm droite	00008350	5	-	-	-	-	-	-	-	-	-	-	-
Serrure 50 mm axe 25 mm gauche	00008351	5	-	-	-	-	-	-	-	-	-	-	-
Serrure 55 mm axe 30 mm droite	00008360	5	-	-	-	-	-	-	-	-	-	-	-
Serrure 55 mm axe 30 mm gauche	00008361	5	-	-	-	-	-	-	-	-	-	-	-
Serrure 60 mm axe 35 mm droite	00008362	5	-	-	-	-	-	-	-	-	-	-	-
Serrure 60 mm axe 35 mm gauche	00008363	5	-	-	-	-	-	-	-	-	-	-	-
Serrure 65 mm axe 40 mm droite	00008370	5	-	-	-	-	-	-	-	-	-	-	-
Serrure 65 mm axe 40 mm gauche	00008371	5	-	-	-	-	-	-	-	-	-	-	-

Non stocké/Non-stored/Producto no estocado - Sur stock Europe Zone 1 et Zone 2, nous consulter pour délai d'approvisionnement - Epuisement/Stock depletion/Agotamiento del stock

Serrures pour meubles / BOÎTIER DE SERRURE UNIVERSELLE PROTECT



GARANTIE

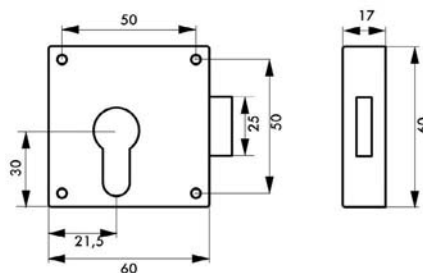

Description/Description/Descripción

Coffre en alliage moulé. Pêne en alliage.
Pour cylindre profilé européen. Réversible
Moulded alloy case. Moulded alloy bolt. To be used with European cylinder.
Caja de aleación moldeada. Pestillo de aleación. Para cilindro perfilado europeo.

Finition/Finish/Acabado

Nickelé
Nickel plated
Niquelado

Utilisation/Use/Utilización

Porte d'ameublement
Furnishing door
Puerta de muebles

Designation	Boite	Colis.	Prix	Sachet	Colis.	Prix	Brochable					Colis.	Prix
							France	Euro 1	Euro 2	Euro 3	Euro 4		
Boîtier serrure universelle à cylindre profilé	-	-	-	00907495	25	-	00107495	-	-	-	-	10	-

Serrures pour meubles / LOQUETEAU À BILLE ECO



GARANTIE

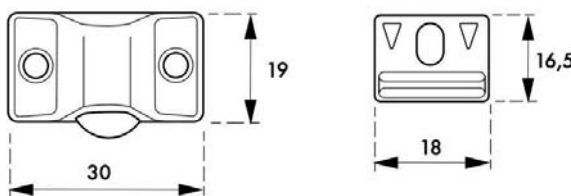

Description/Description/Descripción

Loqueteau et contre-plaque acier nickelé. Bille chromé. A visser.
Nickel-plated steel latch and counterplate. Chrome plated ball. To be screwed.
Cuerpo y contraplaca de acero niquelado. Bola cromada. Para ser atornillado.

Finition/Finish/Acabado

Nickelé
Nickel plated
Niquelado

Utilisation/Use/Utilización

Porte d'ameublement
Furnishing door
Puerta de muebles

Designation	Boite	Colis.	Prix	Sachet	Colis.	Prix	Brochable					Colis.	Prix
							France	Euro 1	Euro 2	Euro 3	Euro 4		
Loqueteau à bille	-	-	-	00987637	1	-	00187637	-	-	-	-	1	-

LOQUETEAU / MAGNETIQUE ECO

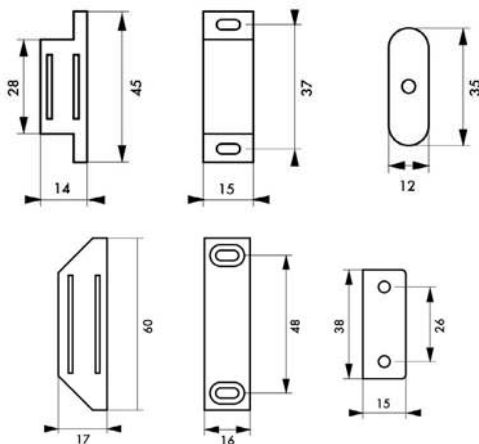

GARANTIE

Description/Description/Descripción

Corps moulé. Armature mobile permettant le rattrapage de jeu et l'amortissement des chocs.

Moulded case. Armature absorbing shocks

Cuerpo moldeado. Armadura móvil que permite la recuperación de holgura y la amortiguación de los golpes.

Finition/Finish/Acabado

Marron.

Brown

Marrón

Utilisation/Use/Utilización

Porte d'ameublement

Furnishing door

Puerta de muebles

Designation	Boite	Colis.	Prix	Sachet	Colis.	Prix	Brochable					Colis.	Prix
							France	Euro 1	Euro 2	Euro 3	Euro 4		
Loqueteau magnétique force 1	-	-	-	00910119	50	-	-	-	-	-	-	-	-
Loqueteau magnétique force 2	-	-	-	00910129	50	-	-	-	-	-	-	-	-
Loqueteau magnétique force 3	-	-	-	00910139	50	-	-	-	-	-	-	-	-

LOQUETEAU / A CROCHET ECO

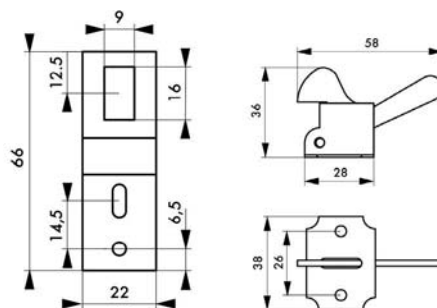

GARANTIE

Description/Description/Descripción

Platine acier emboutie. Gâche plate acier.

Stamped steel plate. Steel flat striker.

Pletina de acero embutido. Cerradero plano de acero.

Finition/Finish/Acabado

Zingué

Zinc plated

Cincado

Utilisation/Use/Utilización

Porte d'ameublement

Furnishing door

Puerta de muebles

Designation	Boite	Colis.	Prix	Sachet	Colis.	Prix	Brochable					Colis.	Prix
							France	Euro 1	Euro 2	Euro 3	Euro 4		
Loqueteau de placard	-	-	-	00911151	50	-	-	-	-	-	-	-	-



Coffres-forts

ECO
PROTECT
RESIST

CAISSE A MONNAIE

MONEY TIME



912

ARMOIRE A CLES

KIBOX



912

Boîte à clés à combinaison



913

COFFRE DE SECURITE

SEDAN



914

VINCENNES



915

FRONTENAC



916

EDIMBOURG



917

COFFRE-FORT

VAUBAN



918

PIERREFONDS



919

BRAN



920

RAMBURES



921

RIVOLI



922

FALAISE



923

WINDSOR



924

COFFRE-FORT POUR CLES

BOYARD



925

AMOIRES A FUSILS

BRISSAC



926

CARDIFF



926

DURBAN



927

MONTERIA



928



Caissette à monnaie / MONEY TIME

ECO



GARANTIE



013215

Dimensions exterieures mm

	H.	L.	P.
013215	80	152	118
013216	90	200	160
013217	90	250	200
013218	90	300	240

Description/Description/Descripción

Acier embouti, poignée chromée. Serrure à cylindre (2 clés fournies). Compartiment interne à monnaie en P.V.C., amovible

Pressed steel, chrome handle. Cylinder lock (2 keys included). Internal PVC removable coin compartment.

Acero embutido, asa cromada. Cerradura de cilindro (se suministran 2 llaves). Compartimento interior fijo para monedas en PVC.

Finition/Finish/Acabado

Epoxy couleurs variées selon disponibilité.

Epoxy, various colours (according to availability).

Epoxi en diversos colores según disponibilidad.

Utilisation/Use/Utilización

Caissette métal idéale pour ranger la monnaie

Metal cash box, ideal for coin storage

Caja metálica ideal para guardar



X 2

Designation	Boite	Colis.	Prix	Sachet	Colis.	Prix	Brochable					Colis.	Prix
							France	Euro 1	Euro 2	Euro 3	Euro 4		
MONEY TIME 1 • Largeur 152	00013215	1	-	-	-	-	-	-	-	-	-	-	-
MONEY TIME 2 • Largeur 200	00013216	1	-	-	-	-	-	-	-	-	-	-	-
MONEY TIME 3 • Largeur 250	00013217	1	-	-	-	-	-	-	-	-	-	-	-
MONEY TIME 4 • Largeur 300	00013218	1	-	-	-	-	-	-	-	-	-	-	-

Armoire à clés / KIBOX

ECO



GARANTIE



013219

Dimensions exterieures mm

	H.	L.	P.	Nombre de clés
013219	200	160	75	20 clés
013220	300	240	75	45 clés
013221	300	240	75	93 clés

Description/Description/Descripción

Acier embouti. Crochets fixes. Fixation murale (matériel pour la fixation fourni). Cloison supplémentaire (Réf. : 013221). Serrure à cylindre (2 clés fournies). Capacité jusqu'à 93 clés.

Pressed steel. Fixed hooks. Wall mounting (mounting hardware included). Extra leaf (Ref.: 013221). Cylinder lock (2 keys included). Capacity up to 94 keys.

Acero embutido. Ganchos fijos. Instalación en pared (se suministra el material para la instalación). Panel adicional

(Ref.: 013221). Cerradura de cilindro (se suministran 2 llaves).

Finition/Finish/Acabado

Epoxy beige

Epoxy beige

Amarillento epoxy

Utilisation/Use/Utilización

Stockage de clés

Key storage

Almacenamiento de llaves.



X 2

Designation	Boite	Colis.	Prix	Sachet	Colis.	Prix	Brochable					Colis.	Prix
							France	Euro 1	Euro 2	Euro 3	Euro 4		
KIBOX 1 • 20 clés	00013219	1	-	-	-	-	-	-	-	-	-	-	-
KIBOX 2 • 45 clés	00013220	1	-	-	-	-	-	-	-	-	-	-	-
KIBOX 3 • 93 clés	00013221	1	-	-	-	-	-	-	-	-	-	-	-

Armoire à clés / À COMBINAISON

ECO



GARANTIE



CODE MODIFIABLE

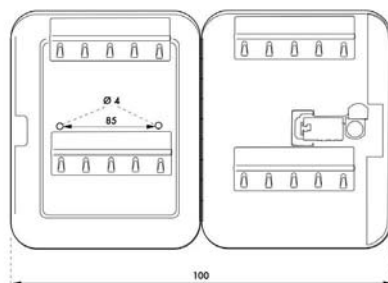

Description/Description/Descripción

Acier embouti. 30 crochets fixes. Mécanisme à 3 viroles. Combinaison modifiable. Ouverture par bouton tournant. Fixation murale (matériel pour la fixation fourni).

Pressed steel, 30 fixed hooks. 3 dials mechanism. Resettable combination. Opening by turning knob. Wall mounting (mounting hardware included).

Acero embutido. 30 ganchos fijos. Mecanismo de 3 virolas. Combinación modificable. Apertura mediante un pomo. montaje en pared (accesorios de montaje incluidos).

Finition/Finish/Acabado

Epoxy noir.

Black epoxy.

Epoxi negro.



Designation	Boîte	Colis.	Prix	Sachet	Colis.	Prix	Brochable					Colis.	Prix
							France	Euro 1	Euro 2	Euro 3	Euro 4		
BOÎTE À CLÉS À COMBINAISON - 30 CLÉS	-	-	-	00913224	16	-	-	-	-	-	-	-	-

⚠ Non stocké/Non-stored/Producto no estocado - 📦 Sur stock Europe Zone 1 et Zone 2, nous consulter pour délai d'approvisionnement - ⚠ Epuisement/Stock depletion/Agotamiento del stock

Coffret de sécurité / SEDAN

ECO



GARANTIE



X 2



2 pênes



Epaisseur porte



Epaisseur corps

Dimensions extérieures mm		
H.	L.	P.
250	350	250

Dimensions Intérieures mm		
H.	L.	P.
246	346	233

Dimensions porte mm	
H.	L.
209	308

Nbr de pênes	
Horiz.	Verti.
2	-

Poids	Litres
Kg.	l.
9	15

Description/Description/Descripción

Fermeture par clé. Serrure de sécurité à double panneau asymétrique à gorges. Verrouillage par double pêne Ø 18mm. Clé prisonnière serrure ouverte. Epaisseur du coffre : 1,5 mm. Epaisseur de la porte : 3 mm. 4 Trous pour fixation au dos et à la base (accessoires fournis). *Steel. The SEDAN safe can be easily secured to the floor or the wall for improved removal-resistance. (accessories included) Key captive when lock open.*

Acero. La caja fuerte SEDAN se instala tanto en suelo como en pared para una mayor resistencia al arranque (se suministran los accesorios). Llave prisionera de cerradura abierta.

Finition/Finish/Acabado

Epoxy beige

Beige epoxy

Epoxi en beige.

Utilisation/Use/Utilización

Adapté pour petits objets de valeur

Suitable for small valuables

Adaptado para pequeños objetos

Designation	Boite	Colis.	Prix	Sachet	Colis.	Prix	Brochable					Colis.	Prix
							France	Euro 1	Euro 2	Euro 3	Euro 4		
SEDAN • 2 pênes	00013201	1	-	-	-	-	-	-	-	-	-	-	-

⚠ Non stocké/Non-stored/Producto no estocado - 📦 Sur stock Europe Zone 1 et Zone 2, nous consulter pour délai d'approvisionnement - 🇪🇺 Epuisement/Stock depletion/Agotamiento del stock

Coffret de sécurité / VINCENNES

ECO



GARANTIE



CODE MODIFIABLE



013288



013222



013290



Code clavier



2 pènes



3 mm

Epaisseur porte



1 mm

Epaisseur corps

	Dimensions extérieures mm			Dimensions Intérieures mm			Dimensions porte mm		Nbr de pènes		Poids	Litres
	H.	L.	P.	H.	L.	P.	H.	L.	Horiz.	Verti.	Kg.	l.
013222	200	310	200	198	308	185	159	269	2	-	4,2	9
013200	250	350	250	248	348	235	209	309	2	-	5,68	16,5
013288	500	360	330	496	356	312	455	315	2	-	18	53
013290	195	420	365	185	410	305	150	385	2	-	9	13,7

Description/Description/Descripción

Fermeture par code. Serrure de sécurité électronique à code à combinaison modifiable. Code de 3 à 8 chiffres. Alimentation par 4 piles de 1,5V type LR6 (piles fournies). Verrouillage par double pêne Ø 16 mm. 4 Trous pour fixation au dos et à la base (accessoires fournis). Fourni avec 2 clés de secours.

Safe with permanent memory electronic lock; code remains in memory even when the batteries are changed. Power: 4x1.5V LR6/AA batteries. (Batteries included). The VINCENNES safe can be easily secured to the floor or the wall for improved removal-resistance. (accessories included). Key opening in emergency. (2 keys supplied).

Acero. Caja fuerte equipada con una cerradura electrónica mediante código con memoria permanente: su código permanece en memoria incluso cuando cambia

las pilas. Alimentación con 4 pilas tipo LR6 de 1,5 V (se suministran las pilas). La caja fuerte se instala tanto en suelo como en pared (se suministran los accesorios). Desbloqueo posible con llave (se suministran 2 llaves).

Finition/Finish/Acabado

Epoxy beige
Beige epoxy
Epoxi en beige

Utilisation/Use/Utilización

Convient pour les petits objets de valeur / ordinateur portable
Suitable for small valuables / Laptop
Adaptado para pequeños objetos / Laptop

Designation	Boite	Colis.	Prix	Sachet	Colis.	Prix	Brochable					Colis.	Prix
							France	Euro 1	Euro 2	Euro 3	Euro 4		
VINCENNES 1 • 2 pènes	00013222	1	-	-	-	-	-	-	-	-	-	-	-
VINCENNES 2 • 2 pènes	00013200	1	-	-	-	-	-	-	-	-	-	-	-
VINCENNES 3 • 2 pènes	00013288	1	-	-	-	-	-	-	-	-	-	-	-
VINCENNES 4 • 2 pènes pour Laptop	00013290	1	-	-	-	-	-	-	-	-	-	-	-

Non stocké/Non-stored/Producto no estocado - Sur stock Europe Zone 1 et Zone 2, nous consulter pour délai d'approvisionnement - Epuisement/Stock depletion/Agotamiento del stock

Coffre de sécurité / FRONTENAC PROTECT



GARANTIE



X 2



2 pênes



Découpe au laser. Soudure périmétrique continue.



Épaisseur porte



Épaisseur corps

	Dimensions extérieures mm			Dimensions Intérieures mm			Dimensions porte mm		Nbr de pênes		Poids	Litres
	H.	L.	P.	H.	L.	P.	H.	L.	Horiz.	Verti.	Kg.	l.
013202	210	270	200	205	265	150	138	188	2	-	11,5	8,5
013203	210	340	300	205	335	250	138	258	2	-	17,5	17

Description/Description/Descripción

Fermeture par clé. Serrure de sécurité double panneton asymétrique à 6 gorges. Clé prisonnière serrure ouverte. Verrouillage par 2 pênes tournants acier Ø 18 mm. Protection avec plaque d'acier au manganèse à l'endroit de la serrure. Soudure périmétrique continue cadre/corps. 2 trous de fixation au dos et à la base (accessoires fournis). Tablette intérieure amovible.

6 lever security lock with double-bit key. Rotating 18 mm. dia. chrome steel locking bolts. Manganese steel protection plate in lock location. Continuously perimeter frame / body welded. Removable internal shelf. Mounting holes in the back and base (wall plugs included). Key captive when lock open. Use.

Cerradura de seguridad de 6 cuellos y llave de dos

paletones. Pestillos giratorios de acero cromado con Ø 18 mm. Protección con placa de acero de manganese entorno a la cerradura. Soldadura perimétrica continua cuadro/cuerpo. Bandeja interior fija. Orificios de instalación en la parte trasera e inferior (se suministran las clavijas). Llave prisionera de cerradura abierta.

Finition/Finish/Acabado

Epoxy noir

Epoxy

Epoxi

Version/Option/Versión

À poser

Surface mount

Instalación en suelo.

Designation	Boite	Colis.	Prix	Sachet	Colis.	Prix	Brochable					Colis.	Prix
							France	Euro 1	Euro 2	Euro 3	Euro 4		
FRONTENAC 1 • 2 pênes	00013202	1	-	-	-	-	-	-	-	-	-	-	-
FRONTENAC 2 • 2 pênes	00013203	1	-	-	-	-	-	-	-	-	-	-	-

⚠ Non stocké/Non-stored/Producto no estocado - 📦 Sur stock Europe Zone 1 et Zone 2, nous consulter pour délai d'approvisionnement - 📦 Epuisement/Stock depletion/Agotamiento del stock

Coffre de sécurité / EDIMBOURG

PROTECT



GARANTIE



CODE MODIFIABLE



Electronique digitale motorisée avec écran à led



Code clavier



2 pènes



Découpe au laser. Soudure périmétrique continue.



Epaisseur porte



Epaisseur corps

Dimensions extérieures mm			Dimensions Intérieures mm			Dimensions porte mm		Nbr de pènes		Poids	Litres
H.	L.	P.	H.	L.	P.	H.	L.	Horiz.	Verti.	Kg.	l.
210	340	300	205	335	250	138	258	2	-	17,5	17

Description/Description/Descripción

Coffre-fort équipé d'une serrure électronique motorisée à code. Code utilisateur de 3 à 6 chiffres, modifiable. Mémoire permanente : votre code reste mémorisé même lorsque vous changez vos piles. Clavier à commande affleurante. Signalisation visuelle sur l'écran à LED haute Définition. Alimentation interne avec 4 piles de 1,5V LR6 (piles fournies). Boîtier de piles extérieur pour alimentation de secours. Secours par clé d'urgence (2 clés fournies). Verrouillage par 2 pènes acier Ø 18 mm. Soudure périmétrique continue cadre/corps. 2 trous de fixation au dos et à la base (accessoires fournis). Tablette intérieure amovible.

Safe with permanent memory electronic motorised lock; code remains in memory even when the batteries are changed. Membrane keypad. 3 to 6 digit user code. Internal power supply with 4x1.5V LR6/AA batteries (included). External battery connector for. emergency power. Emergency key opening (2 keys included). 18 mm dia chrome steel locking bolts. Removable internal shelf. Mounting holes in the back and base (accessories included).

Caja fuerte equipada con una cerradura electrónica motorizada mediante código con memoria permanente: su código permanece en memoria incluso cuando cambia las pilas. Teclado por comando en flujo. Código de uso de 3 a 6 cifras. Alimentación interna con 4 pilas tipo LR6 de 1,5 V (se suministran pilas). Conector exterior de pilas para alimentación de desbloqueo. Desbloqueo con llave de urgencia (se suministran 2 llaves). Pestillos de acero cromado con Ø 18 mm. Bandeja interior fija.

Finition/Finish/Acabado

Epoxy noir

Epoxy

Epoxi

Utilisation/Use/Utilización

À poser

Surface mount

Instalación en suelo.



Designation	Boite	Colis.	Prix	Sachet	Colis.	Prix	Brochable					Colis.	Prix
							France	Euro 1	Euro 2	Euro 3	Euro 4		
EDIMBOURG • 2 pènes	00013204	1	-	-	-	-	-	-	-	-	-	-	-

Non stocké/Non-stored/Producto no estocado - Sur stock Europe Zone 1 et Zone 2, nous consulter pour délai d'approvisionnement - Epuement/Stock depletion/Agotamiento del stock

Coffre de sécurité / VAUBAN PROTECT



GARANTIE



CODE
MODIFIABLE



Code clavier



2 pènes



Ignifugé

	Dimensions extérieures mm			Dimensions Intérieures mm			Dimensions porte mm		Nbr de pènes		Poids	Litres
	H.	L.	P.	H.	L.	P.	H.	L.	Horiz.	Verti.	Kg.	l.
013295	300	420	350	180	300	215	263	383	2	-	35	12
013296	355	496	390	215	360	250	313	453	2	-	47	19

Description/Description/Descripción

Coffre acier. Protection à la chaleur et au feu 01h00 Code utilisateur de 6 à 8 chiffres. Alimentation interne avec 4 piles 1,5V LR6 (piles fournies). Alarme intégrée. Verrouillage par 2 pènes acier chromé diam 20mm. 3 clés. Secours par clé d'urgence (3 clés fournies)
Steel case. 01h00 Fireproof safe. 6 to 8 digit user code. Internal power supply with 4x 1,5V LR6 AA batteries. Alarm function. 20mm diam chrome steel locking bolts. 3 keys. Emergency key opening (3 keys included)

Caja de acero. A prueba de fuego 01h00. Código de uso de 6 a 8 cifras. Alimentación interna con 4 pilas tipo LR6 de 1,5V (se suministran pilas). Alarma incorporada. Pestillo de acero cromado diam 20mm. 3 llaves. Apertura de urgencia con llave (se suministran 3 llaves)

Finition/Finish/Acabado

Epoxy

Epoxy

Epoxi

Utilisation/Use/Utilización

À poser

Surface mount

Instalación en suelo.

Designation	Boite	Colis.	Prix	Sachet	Colis.	Prix	Brochable					Colis.	Prix
							France	Euro 1	Euro 2	Euro 3	Euro 4		
VAUBAN 1 • 2 pènes	00013295	1	-		-	-	-	-	-	-	-	-	-
VAUBAN 2 • 2 pènes	00013296	1	-		-	-	-	-	-	-	-	-	-

⚠ Non stocké/Non-stored/Producto no estocado - ☑ Sur stock Europe Zone 1 et Zone 2, nous consulter pour délai d'approvisionnement - ☒ Epuisement/Stock depletion/Agotamiento del stock

Coffre-fort / PIERREFONDS

RESIST



GARANTIE



X 2



3 pènes



Découpe au laser. Soudure périmétrique continue.



Epaisseur porte



Epaisseur corps

Dimensions extérieures mm			Dimensions Intérieures mm			Dimensions porte mm		Nbr de pènes		Poids	Litres
H.	L.	P.	H.	L.	P.	H.	L.	Horiz.	Verti.	Kg.	l.
130	220	120	125	215	90	100	175	3	-	4	2,5

Description/Description/Descripción

Fermeture par clé. Serrure de sécurité double panneton asymétrique à 6 gorges. Clé prisonnière serrure ouverte. Verrouillage par 3 pènes acier Ø 10 mm. Pattes d'ancrage pour l'installation au mur, (accessoires fournis).

Fourni avec 2 clés

Asymmetric 6-lever security lock with double-bit key. Key captive when lock open. 3 nickel-plated steel rotating locking bolts, saw resistant, 10 mm. dia. Anchor brackets for wall mounting (accessories included).

Cerradura de seguridad de 6 cuellos asimétricos y llave de dos paletones. Llave prisionera de cerradura abierta. 3 pestillos giratorios de acero niquelado anti-aserrado con Ø 10 mm. Anclajes para instalación en pared (se suministran los accesorios).

Finition/Finish/Acabado

Epoxy Ral : 9006

Epoxy Ral: 9006

Epoxi Ral: 9006

Utilisation/Use/Utilización

À emmurer ou à poser. Installation facile et rapide, peut se fixer à l'intérieur d'un meuble.

Built in or surface mount. Quick and easy installation, can be mounted inside a cabinet.

En pared o suelo. Instalación fácil y rápida, se pueden instalar en el interior de un mueble.



Designation	Boite	Colis.	Prix	Sachet	Colis.	Prix	Brochable					Colis.	Prix
							France	Euro 1	Euro 2	Euro 3	Euro 4		
PIERREFONDS • 3 pènes	00013213	1	-	-	-	-	-	-	-	-	-	-	-

Non stocké/Non-stored/Producto no estocado - Sur stock Europe Zone 1 et Zone 2, nous consulter pour délai d'approvisionnement - Epuisement/Stock depletion/Agotamiento del stock

Coffre-fort / BRAN

RESIST



GARANTIE



X 2



2, 4, 5 pènes



Découpe au laser. Soudure périmétrique continue.



Epaisseur porte



Epaisseur corps

	Dimensions extérieures mm			Dimensions Intérieures mm			Dimensions porte mm		Nbr de pènes		Poids	Litres
	H.	L.	P.	H.	L.	P.	H.	L.	Horiz.	Verti.	Kg.	l.
013207	220	350	300	200	340	245	140	250	2	-	21	18
013208	280	400	350	260	390	295	195	300	2	1+1	34	31
013209	350	470	350	330	460	295	265	370	3	1+1	44	47

Description/Description/Descripción

Fermeture par clé. Serrure de haute sécurité à double panneton asymétrique certifiée EN 1300 à 8 gorges. Clé avec carte de propriété permettant la reproduction des clés exclusivement en usine. Clé prisonnière serrure ouverte. Verrouillage par pènes tournants anti-sciage acier. Ø 22 mm. Soudure périmétrique continue cadre/corps. Protection avec plaque d'acier au manganèse au niveau de la serrure, des pènes horizontaux et partie haute verticale. Profil intérieur spécial offrant une résistance plus longue à l'enfoncement de la porte. Trous de fixation au dos et à la base (accessoires fournis). Tablette intérieure amovible. Fourni avec 2 clés. Certifié selon la norme EN 14450-S2.

High security lock certified to EN 1300 with 8 asymmetric levers. Double-bit key key with ownership card for factory-only duplication. Key captive when lock open. Rotating 22 mm. dia. nickel-plated steel saw-resistant locking bolts. Manganese steel protection at the lock, horizontal bolts and upper vertical section Special internal profile so

the door has greater resistance to being forced inwards. Removable internal.

Cerradura de alta seguridad con certificación EN 1300 de 8 cuellos asimétricos. Llave de dos paletones en tarjeta de propiedad para su reproducción únicamente en fábrica. Llave prisionera de cerradura abierta. Pestillos giratorios de acero niquelado anti-aserrado con Ø 22 mm. Protección de acero de magnesio en la cerradura, los pestillos horizontales y la parte superior vertical. Perfil interior especial que proporciona mayor resistencia al forzado de la puerta.

Finition/Finish/Acabado

Epoxy Ral : 9006

Epoxi Ral: 9006

Epoxi Ral: 9006

Utilisation/Use/Utilización

À poser

Surface mount

Instalación en suelo.

Designation	Boite	Colis.	Prix	Sachet	Colis.	Prix	Brochable					Colis.	Prix
							France	Euro 1	Euro 2	Euro 3	Euro 4		
BRAN 1 • 2 pènes	00013207	1	-	-	-	-	-	-	-	-	-	-	-
BRAN 2 • 4 pènes	00013208	1	-	-	-	-	-	-	-	-	-	-	-
BRAN 3 • 5 pènes	00013209	1	-	-	-	-	-	-	-	-	-	-	-

⚠ Non stocké/Non-stored/Producto no estocado - ☑ Sur stock Europe Zone 1 et Zone 2, nous consulter pour délai d'approvisionnement - ☒ Epuisement/Stock depletion/Agotamiento del stock

Coffre-fort / RAMBURES

RESIST



Code clavier



2, 4, 5 pènes



Epaisseur porte



Epaisseur corps



Découpe au laser. Soudure périmétrique continue.



10 ans

GARANTIE



CODE MODIFIABLE

	Dimensions extérieures mm			Dimensions Intérieures mm			Dimensions porte mm		Nbr de pènes		Poids	Litres
	H.	L.	P.	H.	L.	P.	H.	L.	Horiz.	Verti.	Kg.	l.
013210	220	350	300	200	340	245	140	250	2	-	21	18
013211	280	400	350	260	390	295	195	300	2	1+1	34	31
013212	350	470	350	330	460	295	265	370	3	1+1	44	47

Description/Description/Descripción

Coffre fort équipé d'une serrure électronique à code. Microprocesseur haute technologie de haute fiabilité. Mémoire permanente : votre code reste mémorisé même lorsque vous changez vos piles. Code utilisateur de 6 à 10 chiffres, modifiable. Commande d'ouverture/fermeture et clavier à commande affleurante. Signalisation sonore et visuelle pour confirmation des codes, indication d'erreurs et charge insuffisante (Led et Buzzer). Alimentation interne avec 4 piles alcalines de 1,5V LR6 (excepté pour Mod. RAMBURES 1 : 1 piles 9 V LR 61) - (piles fournies). Contacteur de pile 9V LR61 extérieur pour alimentation de secours. Verrouillage par pènes tournant (excepté pour Mod. RAMBURES 1) anti-sciage acier Ø 22 mm. Soudure périmétrique continue cadre/corps. Protection acier au manganèse au niveau de la serrure et des pènes horizontaux et partie haute verticale. Profil intérieur spécial offrant une résistance plus longue à l'enfoncement de la porte. Trous de fixation au dos et à la base (accessoires fournis) Tablette intérieure amovible. Ouverture d'urgence (excepté pour Mod. RAMBURES 1) par serrure certifiée EN 1300 avec clé à double panneton, 2 clés fournies.

High technology, high reliability microprocessor, 6 to 10 digit user code. Emergency external power source connector on keypad. Rotating 22 mm. dia. nickel-plated

steel saw-resistant locking bolts (RAMBURES 1 has 18 mm. dia. non-rotating locking bolts). Manganese steel protection at the lock, horizontal bolts and upper vertical section. Removable internal shelf. Emergency opening (except for RAMBURES 1) using EN 1300 certified lock with double bit key; 2 keys included.

Microprocesador de última generación y alto nivel de fiabilidad. Código de 6 a 10 cifras. Conexión de alimentación externa de desbloqueo en el teclado. Pestillos giratorios de acero niquelado anti-aserrado con Ø 22 mm (Mod. RAMBURES 1 con pestillos fijos de Ø 18 mm). Protección de acero de magnesio en la cerradura, los pestillos horizontales y la parte superior vertical. Bandeja interior fija. Se suministran los accesorios. Apertura de urgencia (excepto modelo RAMBURES 1) mediante cerradura con certificación EN 1300 con llave de dos paletones (2 llaves).

Finition/Finish/Acabado

Epoxy Ral : 9006

Epoxi Ral: 9006

Epoxi Ral: 9006

Utilisation/Use/Utilización

À poser

Surface mount

Instalación en suelo.

Designation	Boite	Colis.	Prix	Sachet	Colis.	Prix	Brochable					Colis.	Prix
							France	Euro 1	Euro 2	Euro 3	Euro 4		
RAMBURES 1 • 2 pènes	00013210	1	-	-	-	-	-	-	-	-	-	-	-
RAMBURES 2 • 4 pènes	00013211	1	-	-	-	-	-	-	-	-	-	-	-
RAMBURES 3 • 5 pènes	00013212	1	-	-	-	-	-	-	-	-	-	-	-

Coffre-fort / RIVOLI

RESIST



Code clavier



7 pènes



Épaisseur porte



10 ans

GARANTIE



Épaisseur corps



CODE MODIFIABLE



Découpe au laser. Soudure périmétrique continue.

013282	Dimensions extérieures mm			Dimensions Intérieures mm			Dimensions porte mm		Nbr de pènes		Poids	Litres
	H.	L.	P.	H.	L.	P.	H.	L.	Horiz.	Verti.	Kg.	l.
	490	430	400	470	420	345	405	330	3	2+2	61	70

Description/Description/Descripción

Serrure certifiée EN 1300 contrôlée par un système électronique à mémoire non volatile. Commande ouverture/fermeture et clavier à commande affleurante. Alimentation interne avec 4 piles alcalines de 1.5 V AA (non fournies). Alimentation de secours par contact extérieur sur le clavier. Signalisation sonore et visuelle pour codes, indication erreurs et charge insuffisante (Buzzer et Leds). Ptournants en acier nickelé Ø 22 mm (pènes 18 mm pour modèle DMT/3). Protection avec plaques dacier au manganèse au niveau de la serrure et des pènes horizontaux et partie haute verticale. Point spécial offrant une résistance plus longue à l'enfoncement de la porte. Soudures internes réalisées par un système robotisé. Soudure périmétrique continue cadre/corps. Tablette intérieure amovible. Trous de au dos et la base (4+4), chevilles fournies. Peinture époxy au four. Secours par clé durgence à double panneton haute sécurité EVO-LOCK avec carte de propriété (2 clés fournies)

Digital electronic lock EN 1300 certified by a high performing electronic system provided by non-volatile memory. Opening/closing with recessed knob and locking by electromagnet. Internal power with alkaline battery (not included). High quality membrane keyboard with 4 leds. Acoustic and visual signals to codes, errors and internal battery deEmergency external power outlet

with contacts directly on keyboard. Nickel-plated rotating steel bolts 22 mm (DMT/3 ø 18 mm, Lock mechanism protected by a manganese steel plate. Horizontal and top vertical bolts protected by drill resistant manganese-steel plate 3 mm thick, placed askew in order to get the best resistance to drilling. Special door battens for exceptional resistance against robbery attempts using a sledge hammer. Internally welded by a robot-controlled system. Front panel seam-welded to the casing by a robot-controlled system. Removable internal shelf. Base and back holes. Screw anchor bolts provided. . Key opening in emergency (2 keys supplied)

Finition/Finish/

Peinture epoxy

Oven dried thermo-hardening powder painting



Designation	Boite	Colis.	Prix	Sachet	Colis.	Prix	Brochable					Colis.	Prix
							France	Euro 1	Euro 2	Euro 3	Euro 4		
RIVOLI • 7 pènes	00013282	1	-		-	-	-	-	-	-	-	-	-

Coffre-fort / FALAISE

RESIST



GARANTIE



X 2



4 pènes



Découpe au laser. Soudure périmétrique continue.



Epaisseur porte



Epaisseur corps

	Dimensions extérieures mm			Dimensions Intérieures mm			Dimensions porte mm		Nbr de pènes		Poids	Litres
	H.	L.	P.	H.	L.	P.	H.	L.	Horiz.	Verti.	Kg.	l.
013205	270	390	200	245	365	150	195	300	2	1+1	18	14

Description/Description/Descripción

A emmurer. Fermeture par clé. Serrure de haute sécurité à double panneton asymétrique certifiée EN 1300 à 8 gorges. Clé avec carte de propriété permettant la reproduction des clés exclusivement en usine. Clé prisonnière serrure ouverte. Verrouillage par 4 pènes tournants anti-sciage acier Ø 22 mm. Soudure périmétrique continue cadre/corps. Protection avec plaque d'acier au manganèse au niveau de la serrure. Profil intérieur spécial offrant une résistance plus longue à l'enfoncement de la porte. Ailettes d'ancrage anti-arrachement à l'arrière du coffre. Tablette intérieure amovible. Fourni avec 2 clés. Certifié selon la norme EN 14450-S2.

High security lock certified to EN 1300 with 8 asymmetric levers. Double-bit key key with ownership card for factory-only duplication. Key captive when lock open. Rotating 22 mm. dia. nickel-plated steel saw-resistant locking bolts. Manganese steel protection at the lock, horizontal bolts and upper vertical section. Special internal profile so the door has greater resistance to being forced inwards. An-

ti-removal anchoring fins to rear face. Removable internal shelf.

Llave de dos paletones con tarjeta de propiedad para su reproducción únicamente en fábrica. Llave prisionera de cerradura abierta. Pestillos giratorios de acero niquelado anti-aserrado con Ø 22 mm. Protección de acero de magnesio en la cerradura, los pestillos horizontales y la parte superior vertical. Perfil interior especial que proporciona mayor resistencia al forzado de la puerta. Aleta de anclaje anti-arrancamiento en la parte trasera de la caja. Bandeja interior fija.

Finition/Finish/Acabado

Epoxy Ral : 9006

Epoxi Ral: 9006

Epoxi Ral: 9006

Utilisation/Use/Utilización

À emmurer

Built in

Instalación en muro.

Designation	Boite	Colis.	Prix	Sachet	Colis.	Prix	Brochable					Colis.	Prix
							France	Euro 1	Euro 2	Euro 3	Euro 4		
FALAISE • 4 pènes	00013205	1	-	-	-	-	-	-	-	-	-	-	-

Non stocké/Non-stored/Producto no estocado - Sur stock Europe Zone 1 et Zone 2, nous consulter pour délai d'approvisionnement - Epuement/Stock depletion/Agotamiento del stock

Coffre-fort à emmurer / WINDSOR

RESIST



GARANTIE



CODE MODIFIABLE



Code clavier



4 pènes



Découpe au laser. Soudure périmétrique continue.



Épaisseur porte

Dimensions extérieures mm			Dimensions Intérieures mm			Dimensions porte mm		Nbr de pènes		Poids	Litres
H.	L.	P.	H.	L.	P.	H.	L.	Horiz.	Verti.	Kg.	l.
270	390	200	245	365	150	195	300	2	1+1	18	14

Description/Description/Descripción

A emmurer. Coffre fort équipé d'une serrure électronique à code. Microprocesseur haute technologie de haute fiabilité. Mémoire permanente : votre code reste mémorisé même lorsque vous changez vos piles. Code utilisateur de 6 à 10 chiffres, modifiable. Commande d'ouverture/fermeture et clavier à commande affleurante. Signalisation sonore et visuelle pour confirmation des codes, indication d'erreurs et charge insuffisante (Led et Buzzer). Alimentation interne avec 4 piles alcalines de 1,5V LR6 (piles fournies). Contacteur de pile 9V LR61 extérieure pour alimentation de secours. Verrouillage par 4 pènes tournants anti-sciage acier Ø 22 mm. Protection avec plaque d'acier au manganèse à l'endroit de la serrure. Profil intérieur spécial offrant une résistance plus longue à l'enfoncement de la porte. Ailettes d'ancrage anti-arrachement à l'arrière du coffre. Tablette intérieure amovible. Ouverture d'urgence par serrure certifiée EN 1300 avec clé à double panneton, 2 clés fournies.

High technology, high reliability microprocessor, 6 to 10 digit user code. Internally powered by 4x1.5V LR6/AA alkaline batteries (included). Emergency external power source connector on keypad. Rotating 22 mm. dia. nickel-plated steel saw-resistant locking bolts. Manganese

steel protection at the lock, horizontal bolts and upper vertical section. Special internal profile so the door has greater resistance to being forced inwards. Removable internal shelf. Emergency opening using EN 1300 certified lock with double bit key; 2 keys included.

Microprocesador de última generación y alto nivel de fiabilidad. Código de 6 a 10 cifras. Conexión de alimentación externa de desbloqueo en el teclado. Pestillos giratorios de acero niquelado anti-aserrado con Ø 22 mm. Protección de acero de magnesio en la cerradura, los pestillos horizontales y la parte superior vertical. Perfil interior especial que proporciona mayor resistencia al forzado de la puerta. Bandeja interior fija. Apertura de urgencia mediante cerradura con certificación EN 1300 con llave de dos paletones (2 llaves).

Finition/Finish/Acabado

Epoxy Ral : 9006

Epoxi Ral: 9006

Epoxi Ral: 9006

Utilisation/Use/Utilización

À emmurer

Built in

Instalación en muro

Designation	Boite	Colis.	Prix	Sachet	Colis.	Prix	Brochable					Colis.	Prix
							France	Euro 1	Euro 2	Euro 3	Euro 4		
WINDSOR • 4 pènes	00013206	1	-	-	-	-	-	-	-	-	-	-	-

⚠ Non stocké/Non-stored/Producto no estocado - 📦 Sur stock Europe Zone 1 et Zone 2, nous consulter pour délai d'approvisionnement - 📦 Epuisement/Stock depletion/Agotamiento del stock

Coffre-fort pour clés / BOYARD

RESIST



GARANTIE



CODE MODIFIABLE

POUR 120 CLES AVEC PANNEAU INTERIEUR MOBILE



Code clavier



4 pènes



Découpe au laser. Soudure périmétrique continue.



Epaisseur porte



Epaisseur corps



clés possibles

Dimensions extérieures mm			Dimensions Intérieures mm			Dimensions porte mm		Nbr de pènes		Poids	Nbr de clés
H.	L.	P.	H.	L.	P.	H.	L.	Horiz.	Verti.	Kg.	
470	360	140	460	350	120	41	29	2	-	27	120

Description/Description/Descripción

Coffre fort équipé d'une serrure électronique à code. Microprocesseur haute technologie de haute fiabilité. Mémoire permanente : votre code reste mémorisé même lorsque vous changez vos piles. Code utilisateur de 6 à 10 chiffres, modifiable. Commande d'ouverture/fermeture et clavier à commande affleurante. Signalisation sonore et visuelle pour confirmation des codes, indication d'erreurs et charge insuffisante (Led et Buzzer). Alimentation interne avec 4 piles alcalines de 1,5V LR6 (piles fournies). Contacteur de pile 9V LR61 extérieur pour alimentation de secours. Verrouillage par 2 pènes tournants anti-sciage acier Ø 22 mm. Protection avec plaque d'acier au manganèse à l'endroit de la serrure. 4 trous de fixation au dos (accessoires fournis). Crochets métalliques et numéros adhésifs. Ouverture d'urgence par serrure certifiée EN 1300 avec clé à double panneton, 2 clés fournies.

High technology, high reliability microprocessor, 6 to 10 digit user code. Internal power supply with 4x1.5V LR6/AA alkaline batteries (included). Emergency external power source connector on keypad. Rotating 22 mm. dia. nickel-plated steel saw-resistant locking bolts Manganese steel protection at the lock. Metal hooks and self-adhesive

numbers; 4 rear mounting holes, wall plugs included. EN 1300 certified lock with double bit key (2 keys included) for emergency opening

Microprocesador de última generación y alto nivel de fiabilidad, Código de 6 a 10 cifras. Alimentación interna con 4 pilas alcalinas tipo LR6 de 1,5 V para el modelo (se suministran las pilas). Conexión de alimentación externa de desbloqueo en el teclado. Pestillos giratorios de acero niquelado anti-aserrado con Ø 22 mm. Protección de acero de manganeso entorno a la cerradura. Ganchos metálicos y números adhesivos. 4 orificios de instalación en la parte trasera (se suministran las clavijas). Apertura de urgencia mediante cerradura con certificación EN 1300 con llave de dos paletones (2 llaves).

Finition/Finish/Acabado

Epoxy Ral : 9006

Epoxi Ral: 9006

Epoxi Ral: 9006

Utilisation/Use/Utilización

À poser

Surface mount

Instalación en suelo.



Designation	Boite	Colis.	Prix	Sachet	Colis.	Prix	Brochable					Colis.	Prix
							France	Euro 1	Euro 2	Euro 3	Euro 4		
BOYARD • 2 pènes	00013214	1	-	-	-	-	-	-	-	-	-	-	-

Non stocké/Non-stored/Producto no estocado - Sur stock Europe Zone 1 et Zone 2, nous consulter pour délai d'approvisionnement - Epuement/Stock depletion/Agotamiento del stock

Armoire à fusils / BRISSAC

ECO



2 pènes



5 fusils



Épaisseur porte



Épaisseur corps



Dimensions extérieures mm			Dimensions Intérieures mm			Dimensions porte mm		Nbr de pènes		Poids	Litres
H.	L.	P.	H.	L.	P.	H.	L.	Horiz.	Verti.	Kg.	l.
1250	310	200	1246	305	180	1175	220	2	-	29	-

Description/Description/Descripción

Fermeture par clé. Serrure de sécurité à double panneton asymétrique à gorges. Clé prisonnière serrure ouverte. Verrouillage par double pêne Ø 18 mm. Épaisseur du coffre : 2 mm. Épaisseur de la porte : 3 mm. Râtelier pour 5 fusils et tapis à la base. 2 Trous pour fixation au dos et à la base. 2 clés.

Key operated. Asymmetric double-bit lever security lock. Key captive when lock open. Twin 18 mm dia. locking bolts. Thickness of cabinet body: 2 mm. Thickness of door: 3 mm. Rack for 5 shotguns/rifles and carpeting to the base. 2 fixing holes in the back and base. 2 keys

Cierre con llave. Cerradura de

seguridad de dos paletones asimétricos con cuellos. Llave prisionera de cerradura abierta. Sistema de cierre mediante pestillo doble de Ø 18 mm. Grosor de la caja: 2 mm. Grosor de la puerta: 3 mm. Estantería para 5 fusiles y tapete en la base. 2 orificios de instalación en la parte trasera e inferior. 2 llaves.

Finition/Finish/Acabado

Epoxy
Epoxy
Epoxi



GARANTIE



X 2

Designation	Boite	Colis.	Prix	Sachet	Colis.	Prix	Brochable					Colis.	Prix
							France	Euro 1	Euro 2	Euro 3	Euro 4		
BRISSAC • 2 pènes	00013284	1	-	-	-	-	-	-	-	-	-	-	-

Armoire à fusils / CARDIFF

PROTECT



Code clavier



4 pènes



5 fusils



Épaisseur porte



Épaisseur corps



Dimensions extérieures mm			Dimensions Intérieures mm			Dimensions porte mm		Nbr de pènes		Poids	Litres
H.	L.	P.	H.	L.	P.	H.	L.	Horiz.	Verti.	Kg.	l.
1450	350	300	1440	340	220	-	-	2	2	56	-

Description/Description/Descripción

Fermeture par code. Serrure de sécurité électronique à code à combinaison modifiable. Code de 3 à 8 chiffres. Alimentation par 4 piles de 1,5V type LR6 (piles fournies). Verrouillage par 4 pènes Ø 20 mm. Épaisseur du coffre : 2,5 mm. Épaisseur de la porte : 4 mm. Râtelier pour 5 fusils et tapis à la base. Coffret interne pour munitions avec serrure à cylindre (2 clés). Support pour accessoires dans la porte. 4 Trous pour fixation au dos. 2 clés de secours.

Touchpad code locking. Electronic security combination lock with user-changeable code. Code length of 3 to 8 digits. Internal power supply with 4x1.5V LR6/AA batteries (included). Twin 16 mm dia. locking bolts. Thickness of safe body: 2,5 mm. Thickness of door: 4 mm. 4 mounting

holes, in the back. 2 emergency keys. Cierre con código. Cerradura de seguridad electrónica con código de combinación modifiable. Código de 3 a 8 cifras. Alimentación con 4 pilas tipo LR6 de 1,5 V (se suministran pilas). Sistema de cierre mediante pestillo doble de Ø 16 mm. Grosor de la caja: 2,5 mm. Grosor de la puerta: 4 mm. 4 orificios de instalación en la parte trasera e inferior. 2 llaves de desbloqueo.

Finition/Finish/Acabado

Epoxy
Epoxy
Epoxi



GARANTIE



CODE MODIFIABLE

Designation	Boite	Colis.	Prix	Sachet	Colis.	Prix	Brochable					Colis.	Prix
							France	Euro 1	Euro 2	Euro 3	Euro 4		
CARDIFF • 4 pènes	00013285	1	-	-	-	-	-	-	-	-	-	-	

Armoire à fusils / DURBAN PROTECT



Exemple
d'utilisation



GARANTIE



X 3



2 pênes



3 fusils



Epaisseur
porte



Epaisseur
corps

	Dimensions extérieures mm			Dimensions Intérieures mm			Dimensions porte mm		Nbr de pênes		Poids	Litres
	H.	L.	P.	H.	L.	P.	H.	L.	Horiz.	Verti.	Kg.	l.
013291	1255	245	205	1250	240	175	1200	195	2		21	52

Description/Description/Descripción

Structure en acier monobloc d2 mm. Porte d2 mm. Serrure de sécurité avec clé à double panneton (2 clés fournies). Clé prisonnière pênes rentrés. 2 pênes tournants anti-sciage en acier nickelé Ø 18 mm. Râtelier en caoutchouc pour 3 fusils et tapis à la base. Petit compartiment sur la porte. Trous pour au dos et à la base (2+2). Peinture époxy au four.

One-piece steel construction of 2 mm thickness. Thickness of door 2 mm. Security lock with double-bitted key. Key-retaining lock in open position. 2 frontal nickel-plated steel bolts Ø 18 mm. Equipped with rubber rack for 3 riand carpet on base. Small removable interior storage to

be on the internal side of door. Pre-drilled anchor holes on and wall mounting (2+2). Anchor bolts supplied.

Cierre con llave. Cerradura de seguridad de dos paletones asimétricos con cuellos. Llave prisionera de cerradura abierta. Sistema de cierre mediante pestillo doble de Ø 18 mm. Grosor de la caja: 2 mm. Grosor de la puerta: 3 mm. Estantería para 5 fusiles y tapete en la base. 2 orificios de instalación en la parte trasera e inferior. 2 llaves.

Finition/Finish/Acabado

Peinture époxy
Oven dried thermo-hardening powder painting
Epoxy

Designation	Boite	Colis.	Prix	Sachet	Colis.	Prix	Brochable					Colis.	Prix
							France	Euro 1	Euro 2	Euro 3	Euro 4		
DURBAN 3 FUSILS	00013291	1	-		-	-	-	-	-	-	-	-	-

Non stocké/Non-stored/Producto no estocado - Sur stock Europe Zone 1 et Zone 2, nous consulter pour délai d'approvisionnement - Epuisement/Stock depletion/Agotamiento del stock

Armoire à fusils / MONTERIA PROTECT



GARANTIE



CODE
MODIFIABLE



Exemple
d'utilisation



Code clavier

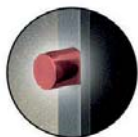

4 pènes



5 fusils



Épaisseur
porte
3
mm



Épaisseur
corps
2
mm



	Dimensions extérieures mm			Dimensions Intérieures mm			Dimensions porte mm		Nbr de pènes		Poids	Litres
	H.	L.	P.	H.	L.	P.	H.	L.	Horiz.	Verti.	Kg.	l.
013286	1450	340	280	1300	335	245	1325	270	4		44	119
013287	1450	535	320	1300	530	285	1325	460	4		74	218

Description/Description/Descripción

Structure en acier monobloc d2 mm. Porte d3 mm.
Épaisseur totale de la porte avec la serrurerie: 55 mm.
Serrure contrôlée par un système électronique à mémoire non volatile. Clavier à boutons poussoirs en abs spécial. Ecran LCD (à cristaux liquides) lumineux à 8 positions. Alimentation par 4 piles de 1.5 V AA (non fournies). 4 pènes en acier nickelé Ø 20 mm. Râtelier en caoutchouc et tapis à la base. Coffret intérieur pour munitions avec fermeture à clé. Tapis à la base. Trous pour au dos et la base (2+2). Peinture époxy au four. Serrure à clé pour ouverture en cas d'urgence (2 clés fournies).

One-piece steel construction of 2 mm thickness. Thickness of door 3 mm. Total door thickness (with lock-panel): 55 mm. Security lock with 6 levers and double-bitted key.

Key-retaining lock in open position. 4 frontal nickel-plated steel bolts Ø 20 mm. Equipped with rubber rack and inside base with carpet. Internal security box with cylinder lock. Pre-drilled anchor holes on and wall mounting (2+2). Cierre con código. Cerradura de seguridad electrónica con código de combinación modificable. Código de 3 a 8 cifras. Alimentación con 4 pilas tipo LR6 de 1,5 V (se suministran pilas). Sistema de cierre mediante pestillo doble de Ø 16 mm. Grosor de la caja: 2,5 mm. Grosor de la puerta: 4 mm. 4 orificios de instalación en la parte trasera e inferior. 2 llaves de desblo queo.

Finition/Finish/Acabado

Peinture époxy
Oven dried thermo-hardening powder painting
Epoxi

Designation	Boite	Colis.	Prix	Sachet	Colis.	Prix	Brochable					Colis.	Prix
							France	Euro 1	Euro 2	Euro 3	Euro 4		
MONTERIA - 5 FUSILS	00013286	1	-		-	-	-	-	-	-	-	-	-
MONTERIA - 10 FUSILS	00013287	1	-		-	-	-	-	-	-	-	-	-

⚠ Non stocké/Non-stored/Producto no estocado - 📦 Sur stock Europe Zone 1 et Zone 2, nous consulter pour délai d'approvisionnement - 📦 Epuisement/Stock depletion/Agotamiento del stock



Poignées



GARNITURE DE SÉCURITÉ	934	GARNITURE DE CHANTIER	938
GARNITURE DE PORTE SUR PLAQUE	944	GARNITURE PLAQUE ETROITE	980
GARNITURE DE PORTE SUR ROSACE	984	POIGNÉE DE TIRAGE	1022
BARRE DE MAINTIEN	1026	POIGNÉE DE FENÊTRE	1029

*Sommaire détaillé par produit
page suivante*









Poignées



















GARNITURE DE SÉCURITÉ

















Ensemble de sécurité		934
Ensemble de sécurité		936
Rosace de sécurité		937

GARNITURE DE CHANTIER





Béquille double		938
Béquille bouton		939
ABBEVILLE		940
LETO		941
MAIA		942
PICARDIE		943

GARNITURE DE PORTE SUR PLAQUE

ARES		944
DEMETER		945
HEBE		946
COQ		947
BOUTON DOUBLE TORSADE		948
BEQUILLE DOUBLE TORSADE		949
PLAQUE DE PROPRETE		950
PLAQUE DE PROPRETE		950
ARTHEMIS		952
ATHENA		953
HELIOS		954
HERA		955
THALIA		956
CHARON		957
DIONYSOS		958
ERIS		959
GAIA		960
PELOPE		961

GOCCIA		962
SELENE		963
VESTA		964
DIANE		965
SULTANE		966
CRECY		967
CHANTILLY		968
THEMIS		969
LOUIS XV		970
SULTANE		971
MARIANNE		974
MIRELLA 2		975
OURANUS		976
POSEIDON		977
STERIAL BY THIRARD		978
BEQUILLE BOUTON PORCELAINE		979

GARNITURE PLAQUE ETROITE





Picardie		980
SAFIR		981
SULTANE		982
SULTANE		983

GARNITURE DE PORTE SUR ROSACE



BOUTON		984
BOUTON		985
POMMEAU LAITON		986
POMMEAU LAITON		986
BEQUILLE DOUBLE		987
BEQUILLE DOUBLE F2		988
BEQUILLE DOUBLE		989
ROSACES		989

BEQUILLE DOUBLE SUR ROSACE		990
CRECY		991
CHANTILLY		992
LUNAR		993
LADA		994
VELES		995
ZIBEL		996
BEQUILLE DOUBLE		997
BEQUILLE DOUBLE		998
BEQUILLE DOUBLE		999
BEQUILLE DOUBLE		1000
BEQUILLE DOUBLE		1001
BEQUILLE DOUBLE		1002
BEQUILLE DOUBLE		1003
STERIAL BY THIRARD		1004
BOSTON		1005
SOLIS		1006
LUXOR		1007
GRID		1008
MONZA		1009
MODENA		1010
GINEVRA		1011
MIRELLA 2		1012
MAXIMA		1013
ARION		1014
ARCHIMEDE		1015
GRAN PRIX		1016
LEONARDO		1017
FIFTY		1018
SHARK		1019
CARRE - FOURRAU - VIS		1020













POIGNÉE DE TIRAGE

Poignée de porte battante inox		1022
Poignée de porte battante inox		1023
Poignée de porte battante inox		1024
Poignée de porte battante inox		1025

BARRE DE MAINTIEN

Barre de maintien inox		1026
Barre de maintien inox		1027
Barre de maintien inox		1028

POIGNÉE DE FENÊTRE

BOÎTIER - ACCESSOIRES - TRINGLES		1029
BOUTON RUSTIQUE		1029
BOUTON BEQUILLE		1030
BOUTON BEQUILLE		1031
BEQUILLE FENETRE		1032
BEQUILLE FENETRE		1033
BOUTON FENETRE		1033
BOUTON PORCELAINE		1034
BOUTON LAITON		1034
ARCHIMEDE		1035
GRAN PRIX		1035
FIFTY		1036
SHARK		1037



Poignée de porte / ENSEMBLE DE SECURITE

ECO



GARANTIE



00092552



00092554

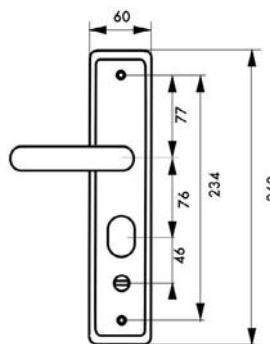
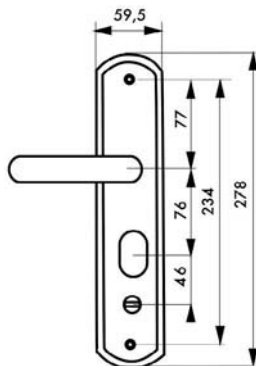

Description/Description/Descripción

Plaques aluminium fondu. Béquilles aluminium fondu. carré acier 8 mm. Vis métaux. Entr'axe de fixation 234 mm.

Stamped aluminium plates. Cast aluminium handles. Steel square spindle 8 mm. Metal screws.

Placas de aluminio embutido. Brazos de aluminio fundido. cuadrado acero de 8 mm. Tornillos para metal de casquillo.

Finition/Finsih/Acabado

Anodisé argent

Silver anodized

Anodizado plata

Versión/Option/Versión

Droite et gauche

Right and left hand

Derecha e izquierda

Designation	Boite	Colis.	Prix	Sachet	Colis.	Prix	Brochable					Colis.	Prix
							France	Euro 1	Euro 2	Euro 3	Euro 4		
ENSEMBLE à condamnation droite plaque BR	00092552 NS	1	-		-	-	-	00593552	00592552	00594552	-	5	-
ENSEMBLE à condamnation gauche plaque BR	00092553 NS	1	-		-	-	-	00593553	00592553	00594553	-	5	-
ENSEMBLE à condamnation droite plaque BC	00092554 NS	1	-		-	-	-	00593554	00592554	00594554	-	5	-
ENSEMBLE à condamnation gauche plaque BC	00592555 NS	1	-		-	-	-	00593555	00592555	00594555	-	5	-

NS Non stocké/Non-stored/Producto no estocado - □ Sur stock Europe Zone 1 et Zone 2, nous consulter pour délai d'approvisionnement - E Epuisement/Stock depletion/Agotamiento del stock

Poignée de porte / ENSEMBLE DE SECURITE

RESIST



GARANTIE



00092538



00092542

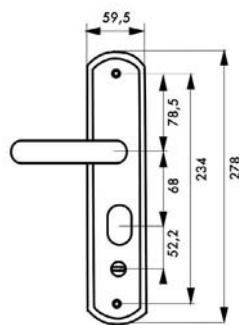
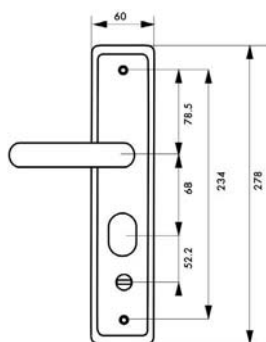

Description/Description/Descripción

Plaques aluminium fondu. Béquilles aluminium fondu. carré acier 8 mm. Vis métaux. Entr'axe de fixation 234 mm.

Stamped aluminium plates. Cast aluminium handles. Steel square spindle 8 mm. Metal screws.

Placas de aluminio embutido. Brazos de aluminio fundido. cuadrado acero de 8 mm. Tornillos para metal de casquillo.

Finition/Finsih/Acabado

Anodisé argent

Silver anodized

Anodizado plata

Versión/Option/Versión

Droite et gauche

Right and left hand

Derecha e izquierda

Designation	Boite	Colis.	Prix	Sachet	Colis.	Prix	Brochable					Colis.	Prix
							France	Euro 1	Euro 2	Euro 3	Euro 4		
ENSEMBLE à condamnation gauche plaque BC	00092541 NS	1	-	-	-	-	-	00593541 NS	00592541 NS	00594541 NS	-	5	-
ENSEMBLE à condamnation droite plaque BC	00092542 NS	1	-	-	-	-	-	00593540 NS	00592540 NS	00594540 NS	-	5	-
ENSEMBLE à condamnation gauche plaque BR	00092539	1	-	-	-	-	-	00593539 NS	00592539 NS	00594539 NS	-	5	-
ENSEMBLE à condamnation droite plaque BR	00092538 NS	1	-	-	-	-	-	00593538 NS	00592538 NS	00594538 NS	-	5	-

NS Non stocké/Non-stored/Producto no estocado - Sur stock Europe Zone 1 et Zone 2, nous consulter pour délai d'approvisionnement - E Epuisement/Stock depletion/Agotamiento del stock



Poignée de porte / ENSEMBLE DE SECURITE RESIST



GARANTIE

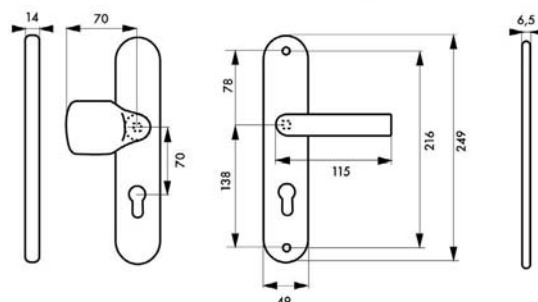

Description/Description/Descripción

Plaques aluminium massif. Béquille et aileron aluminium fondu. Protection de cylindre avec pastille tournante contre l'arrachement et le perçage. carré acier 7 mm avec fourreau. adaptateur 8 mm. Vis métaux M6. Pour porte ép. 40 - 50 mm maxi. Entr'axe de fixation 216 mm. Aluminium plate. Cast aluminium handles. Cylinder protection with revolving tip against tearing and drilling. square steel 7 mm with spindle sleeve 8 mm. Metal screws M6. For 40-50 mm maxi thickness door. Placas de aluminio. Brazos de aluminio fundido. Protección del cilindro con pastilla giratoria contra el desgar-

ramiento y la perforación cuadrado acero de 7 mm con funda 8 mm. Tornillos de metal M6. Para puertas con un espesor máximo de 40-50 mm.

Finition/Finsih/Acabado

Anodisé argent F1, champagne F2 et aspect inox F9. Anodized silver F1, champagne F2 and inox anodized F9. Anodizado plata F1, champán F2 y anodizado plata F9.

Versión/Option/Versión

Béquille double.
Double Handle.
Brazos doble.

Designation	Boite	Colis.	Prix	Sachet	Colis.	Prix	Brochable					Colis.	Prix
							France	Euro 1	Euro 2	Euro 3	Euro 4		
ENSEMBLE DE SECURITE palière anodisé argent F1	00004090	1	-	00904090	5	-	00504090	-	-	-	-	5	-
ENSEMBLE DE SECURITE palière anodisé couleur F2	00004091	1	-	-	-	-	00504091	-	-	-	-	5	-
ENSEMBLE DE SECURITE palière anodisé inox F9	00004092	1	-	-	-	-	00504092	-	-	-	-	5	-
Ensemble de sécurité béquille double Argent F1	00066730	1	-	-	-	-	-	-	-	-	-	-	-
Ensemble de sécurité béquille double couleur F2	00066731	1	-	-	-	-	-	-	-	-	-	-	-
Ensemble de sécurité béquille double aspect inox F9	00066732	1	-	-	-	-	-	-	-	-	-	-	-

⚠ Non stocké/Non-stored/Producto no estocado - 📦 Sur stock Europe Zone 1 et Zone 2, nous consulter pour délai d'approvisionnement - 📦 Epuisement/Stock depletion/Agotamiento del stock

Rosace / DE SECURITE PROTECT



GARANTIE



00992729



00090367

Description/Description/Descripción

Rosace alliage. Pastille tournante acier. Vis métaux long. 80 mm.

Alloy plate. Steel rotating disc. Metal screws long 80 mm. Placa de aleación. Disco giratorio de acero. Tornillos para metal long 80 mm.

Finition/Finsih/Acabado

Nickelé brossé.

Nickel brushed.

Niquel cepillado.

Designation	Boite	Colis.	Prix	Sachet	Colis.	Prix	Brochable					Colis.	Prix
							France	Euro 1	Euro 2	Euro 3	Euro 4		
Paire de rosaces de sécurité nickelé brossé	-	-	-	00992729 NS	10	-	-	-	00192639 NS	-	-	10	-
Paire de rosaces de sécurité chromé	00090367	10	-	00990367	10	-	-	-	-	-	-	-	-

Rosace / DE SECURITE

RESIST



GARANTIE

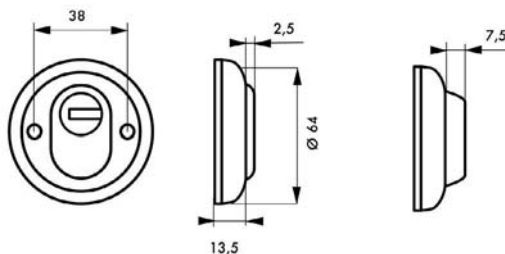

Description/Description/Descripción

Rosace acier. Capot inox 304. Pastille tournante acier cémenté.

Hardened steel plate. Stainless steel cover 304. Hardened steel rotating disc.

Placa de acero cementado. Capó de acero inoxidable.

Finition/Finsih/Acabado

Chromé

Chrome plated

Cromado

Designation	Boite	Colis.	Prix	Sachet	Colis.	Prix	Brochable					Colis.	Prix
							France	Euro 1	Euro 2	Euro 3	Euro 4		
Paire de rosaces de sécurité renforcé chromé	00090368	10	-	-	-	-	-	-	-	-	-	-	-

NS Non stocké/Non-stored/Producto no estocado - S Sur stock Europe Zone 1 et Zone 2, nous consulter pour délai d'approvisionnement - E Epuisement/Stock depletion/Agotamiento del stock



Poignée de porte alu poli / BEQUILLE DOUBLE

ECO



GARANTIE

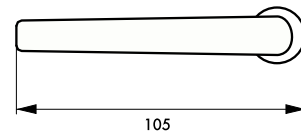
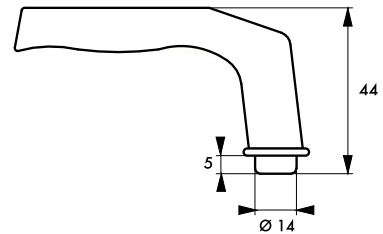

Description/Description/Descripción

Béquilles alliage poli. carré acier. Réglage par vis pointeau. Pour porte + serrure ép. 70 mm maxi à 1 portée. Alloy handles. Steel square spindle. Adjustment by screw. For 70 mm maxi thickness. door and lock with single bossing.

Brazos de aleación acero. Ajuste mediante aguja de punta cónica. Para puertas y cerraduras con un espesor máximo de 70 mm de 1 asiento

Version/Option/Versión

1 portée avec " 6 mm pour serrure à appliquer horizontale. 1 portée avec " 7 mm pour serrure à appliquer ver-

ticale. 1 portée avec " 8 mm pour serrure à appliquer "ALSACE". 2 portées avec " 7 mm pour serrure à encaster. 2 portées avec " 8 mm pour serrure "ALSACE".

Single bossing with " 6 mm for horizontal rim lock. Single bossing with " 7 mm for vertical rim lock. Single bossing with " 8 mm for rim lock "ALSACE". Double bossing with " 7 mm for mortise lock. Double bossing with " 8 mm for mortise lock "ALSACE".

1 asiento con " 6 mm para cerradura de plastrón horizontal. 1 asiento con " 7 mm para cerradura de plastrón vertical. 1 asiento con " 8 mm para cerradura de plastrón "ALSACE".

Designation	Boite	Colis.	Prix	Sachet	Colis.	Prix	Brochable					Colis.	Prix
							France	Euro 1	Euro 2	Euro 3	Euro 4		
BEQUILLE DOUBLE carré 6 mm 1 portée	00000468	10	-	00900468	20	-	00200468	-	-	-	-	10	-
BEQUILLE DOUBLE carré 6 avec fourreau adaptateur 7 mm	-	-	-	00910468	20	-	00210468	-	-	-	-	10	-
BEQUILLE DOUBLE carré 7 mm 2 portées	00000469	10	-	00900469	20	-	00200469	-	-	-	-	10	-
BEQUILLE DOUBLE carré 7 mm 1 portée	00000470	10	-	00900470	20	-	00200470	-	-	-	-	10	-
BEQUILLE DOUBLE carré 6 mm avec fourreau adaptateur 7 mm	-	-	-	00909468	-	-	00209468	-	-	-	-	10	-
BEQUILLE DOUBLE carré 8 mm 2 portées	00001469	10	-	-	-	-	00201469	-	-	-	-	10	-
BEQUILLE DOUBLE carré 8 mm 1 portée	00001470	10	-	-	-	-	00201470	-	-	-	-	10	-

⚠ Non stocké/Non-stored/Producto no estocado - 📦 Sur stock Europe Zone 1 et Zone 2, nous consulter pour délai d'approvisionnement - 📦 Epuisement/Stock depletion/Agotamiento del stock

Poignée de porte alu poli / BEQUILLE - BOUTON

ECO



GARANTIE

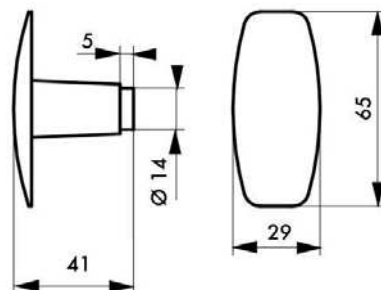

Description/Description/Descripción

Bouton alliage poli. 1 portée. Carré acier 6 Pour porte + serrure ép. 70~mm maxi

Alloy knob. Single bossing. Steel square spindle 6 For 70~mm maxi thickness door and lock.

Botón de aleación. 1 asiento. cuadrado acero de 6 Para puerta + cerradura con un espesor máximo de 70~mm.

Utilisation/Use/Utilización

Pour tous types de serrures à appliquer horizontale

For all kinds of horizontal rim lock

Para todo tipo de cerraduras de plastrón

Designation	Boite	Colis.	Prix	Sachet	Colis.	Prix	Brochable					Colis.	Prix
							France	Euro 1	Euro 2	Euro 3	Euro 4		
BOUTON DOUBLE carré 6 mm 1 portée	00000480	10	-	00900480	20	-	00200480	-	-	-	-	10	-
BOUTON DOUBLE carré 6 avec fourreau adaptateur 7 mm	-	-	-	00910480	20	-	00210480	-	-	-	-	10	-
BOUTON BEQUILLE carré 6 mm 1 portée	00004748	10	-	-	-	-	00204748	-	-	-	-	10	-
BOUTON BEQUILLE carré 6 mm avec fourreau adaptateur 7 mm	-	-	-	-	-	-	00214748	-	-	-	-	10	-

Non stocké/Non-stored/Producto no estocado - Sur stock Europe Zone 1 et Zone 2, nous consulter pour délai d'approvisionnement - Epuement/Stock depletion/Agotamiento del stock



Poignée de porte chromé / ABBEVILLE

ECO



GARANTIE

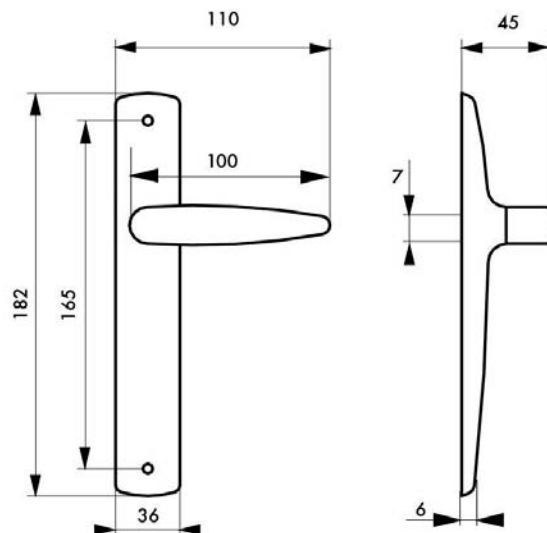

Description/Description/Descripción

Plaques acier embouti. Béquilles alliage fondu. carré acier 7 mm. Vis métaux. Pour porte ép. 45 mm maxi. Entr'axe de fixation 165 mm.

Steel plates. Cast alloy handles. Steel square spindle 7 mm. Metal screws. For 45 mm maxi thickness door. Placas de acero embutido. Brazos de aleación fundida cuadrado acero de 7 mm. Tornillos para metal. Para puertas con un espesor máximo de 45 mm.

Finition/Finish/Acabado

Chromé

Chrome plated

Cromado

Version/Option/Versión

Sans trou pour porte intérieure. Avec bouton de condamnation pour porte de salle de bains et W-C. Avec trou de clé pour porte intérieure. Avec trou de cylindre européen pour porte extérieure.

Without hole for inside door. With locking knob for bathroom doors and WC. With key hole for inside door. With european cylinder hole for entrance door.

Sin orificio para puerta interior. Con botón de condensación para puerta de cuartos de baño y WC. Con orificio de llave para puerta interior. Con orificio de cilindro europeo para puerta exterior.

Designation	Boite	Colis.	Prix	Sachet	Colis.	Prix	Brochable					Colis.	Prix
							France	Euro 1	Euro 2	Euro 3	Euro 4		
ABBEVILLE sans trou BdC	-	-	-	00907150	15	-	-	-	-	-	-	-	-
ABBEVILLE trou de clé, L	-	-	-	00907152	15	-	-	-	-	-	-	-	-
ABBEVILLE trou de cylindre, I	-	-	-	00907153	15	-	-	-	-	-	-	-	-
ABBEVILLE à condamnation	-	-	-	00907151	15	-	-	-	-	-	-	-	-

Poignée de porte argent ou couleur F2 / LETO

ECO



GARANTIE

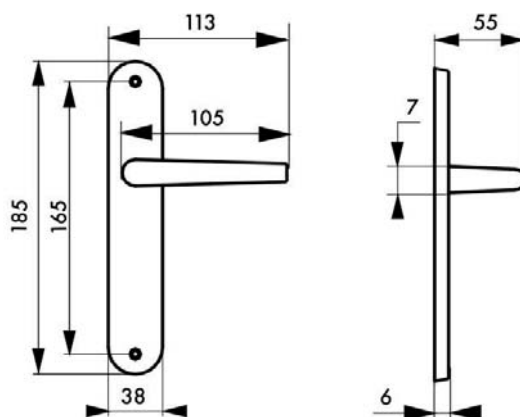

Description/Description/Descripción

Plaques aluminium embouti. Béquilles aluminium fondu. carré acier 7 mm. Vis métaux sécables. Entr'axe de fixation 165 mm.

Aluminium plates. Cast aluminium handles. Steel square spindle 7 mm. Metal screws.

Placas de aluminio embutido. Brazos de aluminio fundida cuadrado acero de 7 mm. Tornillos para metal.

Finition/Finsih/Acabado

Anodisé argent ou couleur F2

Silver or color F2 anodized

Anodizado plata o color F2

Version/Option/Versión

Sans trou pour porte intérieure. Avec bouton de condamnation pour porte de salle de bains et W-C. Avec trou de clé pour porte intérieure. Avec trou de cylindre européen pour porte extérieure.

Without hole for inside door. With locking knob for bathroom doors and WC. With key hole for inside door. With european cylinder hole for entrance door.

Sin orificio para puerta interior. Con botón de condensación para puerta de cuartos de baño y WC. Con orificio de llave para puerta interior. Con orificio de cilindro europeo para puerta exterior.

Designation	Boite	Colis.	Prix	Sachet	Colis.	Prix	Brochable					Colis.	Prix
							France	Euro 1	Euro 2	Euro 3	Euro 4		
LETO sans trou BdC argent	-	-	-	00990190	6	-	00590190	-	-	-	-	5	-
LETO trou de clé, L argent	-	-	-	00990192	6	-	00590192	-	-	-	-	5	-
LETO trou de cylindre, l argent	-	-	-	00990193	6	-	00590193	-	-	-	-	5	-
LETO à condamnation argent	-	-	-	00990191	6	-	00590191	-	-	-	-	5	-
LETO sans trou BdC couleur F2	-	-	-	00990194	6	-	00590194	-	-	-	-	5	-
LETO trou de clé, L couleur F2	-	-	-	00990196	6	-	00590196	-	-	-	-	5	-
LETO trou de cylindre, l couleur F2	-	-	-	00990197	6	-	00590197	-	-	-	-	5	-
LETO à condamnation couleur F2	-	-	-	00990195	6	-	00590195	-	-	-	-	5	-

Non stocké/Non-stored/Producto no estocado - Sur stock Europe Zone 1 et Zone 2, nous consulter pour délai d'approvisionnement - Epuement/Stock depletion/Agotamiento del stock



Poignée de porte argent ou couleur F2 / MAIA

ECO



GARANTIE

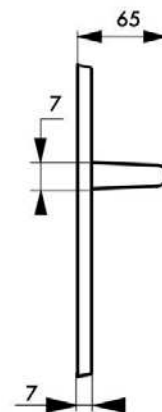
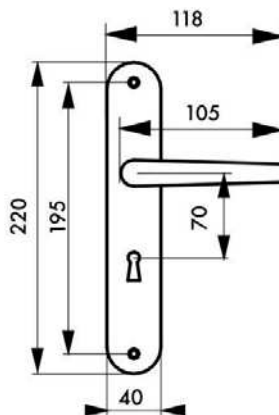

Description/Description/Descripción

Plaques aluminium embouti. Béquilles aluminium fondu. carré acier 7 mm. Vis métaux sécables. Entr'axe de fixation 195 mm.

Aluminium plates. Cast Aluminium handles. Steel square spindle 7 mm. Metal screws.

Placas de aluminio embutido. Brazos de aluminio fundida cuadrado acero de 7 mm. Tornillos para metal.

Finition/Finsih/Acabado

Anodisé argent ou champagne

Silver or champagne anodized

Anodizado plata o champan

Version/Option/Versión

Sans trou pour porte intérieure. Avec bouton de condamnation pour porte de salle de bains et W-C. Avec trou de clé pour porte intérieure et extérieure. Avec trou de cylindre européen pour porte extérieure.

Without hole for inside door. With locking knob for bathroom doors and WC. With key hole for inside door and entrance door. With european cylinder hole for entrance door.

Sin orificio para puerta interior. Con botón de condena-ción para puerta de cuartos de baño y WC. Con orificio de llave para puerta interior y exterior. Con orificio de cilindro europeo para puerta exterior.

Designation	Boite	Colis.	Prix	Sachet	Colis.	Prix	Brochable					Colis.	Prix
							France	Euro 1	Euro 2	Euro 3	Euro 4		
MAIA trou de clé, L argent	-	-	-	00990202	6	-	00590202	-	-	-	-	5	-
MAIA trou de cylindre, l argent	-	-	-	00990203	6	-	00590203	-	-	-	-	5	-
MAIA à condamnation argent	-	-	-	00990201	6	-	00590201	-	-	-	-	5	-
MAIA sans trou BdC couleur F2	-	-	-	00990204	6	-	00590204	-	-	-	-	5	-
MAIA trou de clé, L couleur F2	-	-	-	00990206	6	-	00590206	-	-	-	-	5	-
MAIA trou de cylindre, l couleur F2	-	-	-	00990207	6	-	00590207	-	-	-	-	5	-
MAIA à condamnation couleur F2	-	-	-	00990205	6	-	00590205	-	-	-	-	5	-
MAIA sans trou BdC argent	-	-	-	00990200	6	-	00590200	-	-	-	-	5	-

Poignée de porte F2 / PICARDIE

PROTECT

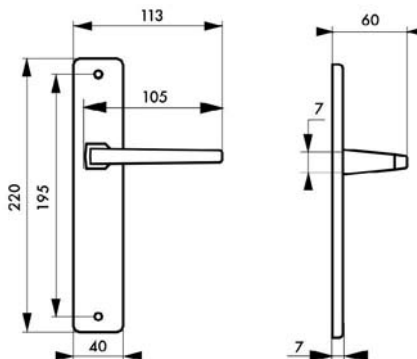

GARANTIE

Description/Description/Descripción

Plaques aluminium embouti. Béquilles aluminium fondu. carré acier 7 mm ou 8 mm. Vis métaux à douille. Pour porte ép. 45 mm maxi. Entr'axe de fixation 195 mm. Stamped aluminium plates. Cast aluminium handles. Steel square spindle 7 mm or 8 mm. Metal screws. For 45 mm maxi thickness door.

Placas de aluminio embutido. Brazos de aluminio fundido. cuadrado acero de 7 u 8 mm. Tornillos para metal de casquillo. Para puertas con un espesor máximo de 45 mm.

Finition/Finsih/Acabado

Anodisé champagne

Champagne anodized

Anodizado champán

Version/Option/Versión

Sans trou, avec bouton de condamnation pour porte

intérieure. Avec condamnation et voyant d'occupation pour salle de bains et W-C. Avec trou de clé pour porte intérieure et extérieure. Avec trou de cylindre européen pour porte extérieure. Avec poignée de tirage extérieure et trou de cylindre pour porte palière.

Without locking knob and indicator for bathroom doors and WC. With locking knob and indicator for indoor. With keyhole for indoor and outdoor. With European cylinder hole for outdoor. With outside finger plate and cylinder hole for outdoor.

Sin orificio, con botón de condenación para puerta interior. Con condenación e indicador luminoso de ocupación para cuartos de baño y WC. Con orificio de llave para puerta interior y exterior. Con orificio de cilindro europeo para puerta exterior. Con tirador exterior y orificio de cilindro para puerta de descansillo.

Designation	Boite	Colis.	Prix	Sachet	Colis.	Prix	Brochable					Colis.	Prix
							France	Euro 1	Euro 2	Euro 3	Euro 4		
PICARDIE sans trou BdC carré 7 mm	-	-	-	-	-	-	00500368	-	-	-	-	10	-
PICARDIE trou de clé, L carré 7 mm	-	-	-	-	-	-	00500370	-	-	-	-	10	-
PICARDIE trou de cylindre, l carré 7 mm entr'axe 70	-	-	-	-	-	-	00500371	-	-	-	-	10	-
PICARDIE trou de cylindre, l carré 8 mm entraxe 92 mm	-	-	-	00901371	10	-	00501371	-	-	-	-	10	-
PICARDIE à condamnation carré 7 mm	-	-	-	-	-	-	00500369	-	-	-	-	10	-
PICARDIE condamnation et voyant carré 7 mm	-	-	-	-	-	-	00501369	-	-	-	-	10	-
PICARDIE trou de cylindre, l palière carré 7 mm	-	-	-	00900372	10	-	00500372	-	-	-	-	10	-
PICARDIE trou de cylindre «renforcé» palière carré 7 mm	00099372	10	-	-	-	-	-	-	-	-	-	-	-
PICARDIE trou de cylindre, l «renforcé» (1/2 ensemble)	00099472	10	-	-	-	-	-	-	-	-	-	-	-
PICARDIE sans trou BdC carré 8x8 mm	00000388	10	-	-	-	-	00500388	-	-	-	-	10	-
PICARDIE trou de clé, L carré 8x72 mm	-	-	-	00900390	10	-	00500390	-	-	-	-	10	-
PICARDIE trou de cylindre, l carré 8x72 mm	-	-	-	00900391	10	-	00500391	-	-	-	-	10	-
PICARDIE à condamnation carré 8x78 mm	00000389	10	-	-	-	-	00500389	-	-	-	-	10	-

Non stocké/Non-stored/Producto no estocado - Sur stock Europe Zone 1 et Zone 2, nous consulter pour délai d'approvisionnement - Epuement/Stock depletion/Agotamiento del stock



Poignée de porte chromé / ARES

ECO



GARANTIE

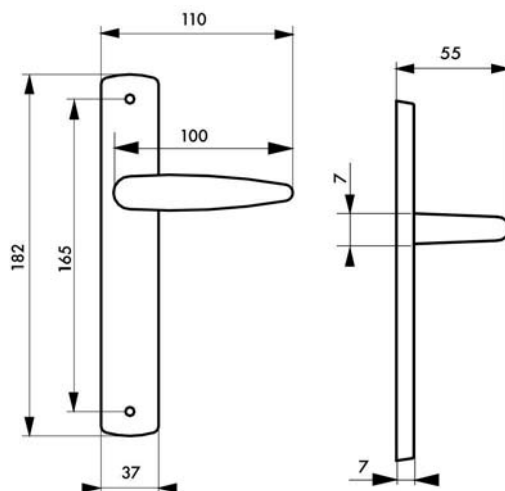

Description/Description/Descripción

Plaques acier embouté. Béquilles alliage fondu. carré acier 7 mm. Vis métaux sécables. Entr'axe de fixation 165 mm.

Steel plates. Cast alloy handles. Steel square spindle 7 mm. Metal screws.

Placas de acero embutido. Brazos de aleación fundida cuadrado acero de 7 mm. Tornillos para metal.

Finition/Finish/Acabado

Chromé

Chrome plated

Cromado

Version/Option/Versión

Sans trou pour porte intérieure. Avec bouton de condamnation pour porte de salle de bains et W-C. Avec trou de clé pour porte intérieure. Avec trou de cylindre européen pour porte extérieure.

Without hole for inside door. With locking knob for bathroom doors and WC. With key hole for inside door. With european cylinder hole for entrance door.

Sin orificio para puerta interior. Con botón de condensación para puerta de cuartos de baño y WC. Con orificio de llave para puerta interior. Con orificio de cilindro europeo para puerta exterior.

Designation	Boite	Colis.	Prix	Sachet	Colis.	Prix	Brochable					Colis.	Prix
							France	Euro 1	Euro 2	Euro 3	Euro 4		
Ares sans trou Bc	-	-	-	00943300	6	-	00543300	-	-	-	-	5	-
Ares trou de clé, L	-	-	-	00943302	6	-	00543302	-	-	-	-	5	-
Ares trou de cylindre, I	-	-	-	00943303	6	-	00543303	-	-	-	-	5	-
Ares à condamnation	-	-	-	00943301	6	-	00543301	-	-	-	-	5	-

⚠ Non stocké/Non-stored/Producto no estocado - 📦 Sur stock Europe Zone 1 et Zone 2, nous consulter pour délai d'approvisionnement - 📦 Epuisement/Stock depletion/Agotamiento del stock

Poignée de porte chromé / DEMETER

ECO



GARANTIE

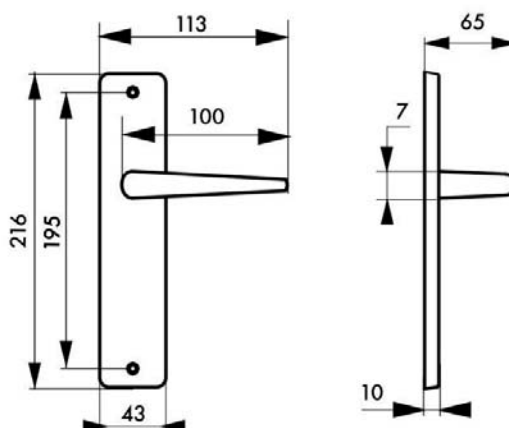

Description/Description/Descripción

Plaques acier embouti. Béquilles alliage fondu. carré acier 7 mm. Vis métaux sécables. Entr'axe de fixation 195 mm.

Steel plates. Cast alloy handles. Steel square spindle 7 mm. Metal screws.

Placas de acero embutido. Brazos de aleación fundida cuadrado acero de 7 mm. Tornillos para metal.

Finition/Finsih/Acabado

Chromé

Chrome plated

Cromado

Version/Option/Versión

Sans trou pour porte intérieure. Avec bouton de condamnation pour porte de salle de bains et W-C. Avec trou de clé pour porte intérieure. Avec trou de cylindre européen pour porte extérieure.

Without hole for inside door. With locking knob for bathroom doors and WC. With key hole for inside door. With european cylinder hole for entrance door.

Sin orificio para puerta interior. Con botón de condenación para puerta de cuartos de baño y WC. Con orificio de llave para puerta interior. Con orificio de cilindro europeo para puerta exterior.

Designation	Boite	Colis.	Prix	Sachet	Colis.	Prix	Brochable					Colis.	Prix
							France	Euro 1	Euro 2	Euro 3	Euro 4		
DEMETER sans trou BdC	-	-	-	00943310	6	-	00543310	-	-	-	-	5	-
DEMETER trou de clé, L	-	-	-	00943312	6	-	00543312	-	-	-	-	5	-
DEMETER trou de cylindre, l	-	-	-	00943313	6	-	00543313	-	-	-	-	5	-
DEMETER à condamnation	-	-	-	00943311	6	-	00543311	-	-	-	-	5	-

Ⓜ Non stocké/Non-stored/Producto no estocado - 📦 Sur stock Europe Zone 1 et Zone 2, nous consulter pour délai d'approvisionnement - ⚠ Epuisement/Stock depletion/Agotamiento del stock



Poignée de porte blanche / HEBE

ECO



GARANTIE

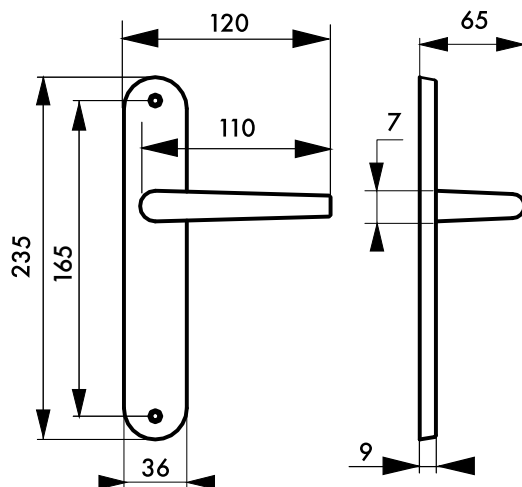

Description/Description/Descripción

Plaques acier embouti. Béquilles aluminium fondu, carré acier 7Vis métaux sécables. Entraxe de fixation 165 ou 195 mm.

Steel plates. Cast aluminium handles. Steel square spindle 7 mm. Metal screws.

Placas de acero embutido. Brazos de aluminio fundida cuadrado acero de 7 mm. Tornillos para metal.

Finition/Finish/Acabado

Laqué blanc

White lacquered

Lacado blanco

Version/Option/Versión

Sans trou pour porte intérieure. Avec bouton de condamnation pour porte de salle de bains et W-C. Avec trou de clé pour porte intérieure. Avec trou de cylindre européen pour porte extérieure.

Without hole for inside door. With locking knob for bathroom doors and WC. With key hole for inside door. With european cylinder hole for entrance door.

Sin orificio para puerta interior. Con botón de condensación para puerta de cuartos de baño y WC. Con orificio de llave para puerta interior. Con orificio de cilindro europeo para puerta exterior.

Designation	Boite	Colis.	Prix	Sachet	Colis.	Prix	Brochable					Colis.	Prix
							France	Euro 1	Euro 2	Euro 3	Euro 4		
HEBE sans trou BdC entraxe 165 mm	-	-	-	00943364	6	-	-	-	-	-	-	-	-
HEBE trou de clé, L entraxe 165 mm	-	-	-	00943366	6	-	-	-	-	-	-	-	-
HEBE à condamnation entraxe 165 mm	-	-	-	00943365	6	-	-	-	-	-	-	-	-
HEBE sans trou BdC entraxe 195 mm	-	-	-	00943360	6	-	00543360	-	-	-	-	5	-
HEBE trou de clé, L entraxe 195 mm	-	-	-	00943362	6	-	00543362	-	-	-	-	6	-
HEBE trou de cylindre, l entraxe 195 mm	-	-	-	00943363	6	-	00543363	-	-	-	-	7	-
HEBE condamnation entraxe 195 mm	-	-	-	00943361	6	-	00543361	-	-	-	-	8	-

⚠ Non stocké/Non-stored/Producto no estocado - 📦 Sur stock Europe Zone 1 et Zone 2, nous consulter pour délai d'approvisionnement - 📦 Epuisement/Stock depletion/Agotamiento del stock

Poignée de porte noire / COQ

ECO



GARANTIE

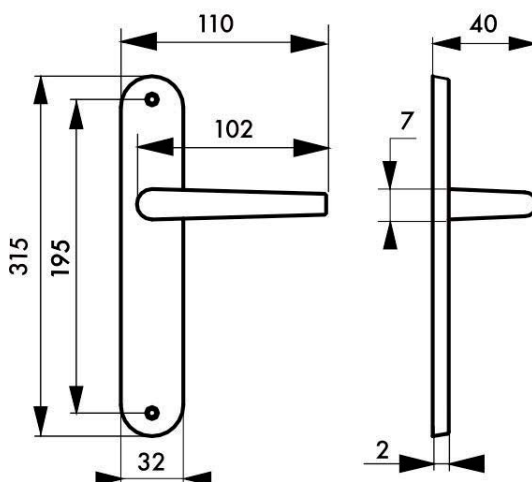

Description/Description/Descripción

Plaques acier. Béquilles alliage fondu. carré acier 7 mm. Vis métaux sécables. Entr'axe de fixation 195 mm. Steel plates. Cast alloy handles. Steel square spindle 7 mm. Metal screws.

Placas de acero. Brazos de aleación fundida cuadrado acero de 7 mm. Tornillos para metal.

Finition/Finish/Acabado

Laqué noir

Black lacquered

Lacado negro

Version/Option/Versión

Sans trou pour porte intérieure. Avec bouton de condamnation pour porte de salle de bains et W-C. Avec trou de clé pour porte intérieure et extérieure. Avec trou de cylindre européen pour porte extérieure.

Without hole for inside door. With locking knob for bathroom doors and WC. With key hole for inside door and entrance door. With european cylinder hole for entrance door.

Sin orificio para puerta interior. Con botón de condensación para puerta de cuartos de baño y WC. Con orificio de llave para puerta interior y exterior. Con orificio de cilindro europeo para puerta exterior.

Designation	Boite	Colis.	Prix	Sachet	Colis.	Prix	Brochable					Colis.	Prix
							France	Euro 1	Euro 2	Euro 3	Euro 4		
Coq sans trou BdC	-	-	-	00943370	6	-	-	-	-	-	-	-	-
Coq trou de clé	-	-	-	00943372	6	-	-	-	-	-	-	-	-
Coq trou de cylindre	-	-	-	00943373	6	-	-	-	-	-	-	-	-
Coq à condamnation	-	-	-	00943371	6	-	-	-	-	-	-	-	-

Non stocké/Non-stored/Producto no estocado - Sur stock Europe Zone 1 et Zone 2, nous consulter pour délai d'approvisionnement - Epuement/Stock depletion/Agotamiento del stock



Poignée de porte noire / BOUTON DOUBLE TORSADE

ECO



GARANTIE

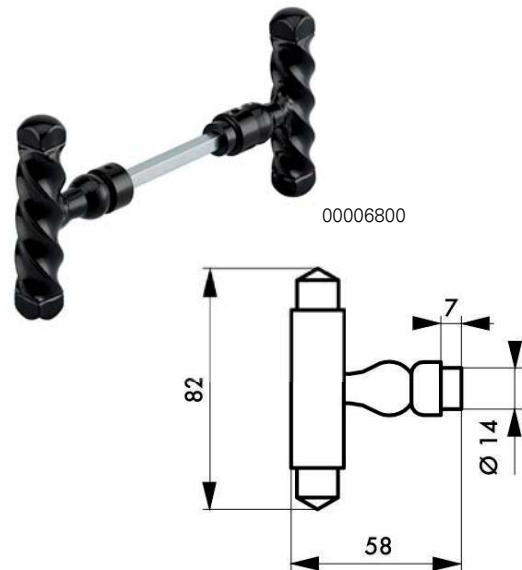
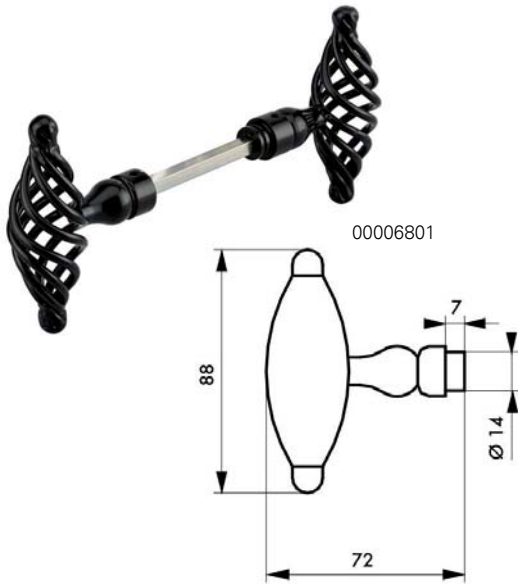

Description/Description/Descripción

Boutons torsadé. 1 portée. carré acier 6 mm. Pour porte + serrure ép. 80 mm maxi.

Twisted knob. Single bossing. Steel square 6 mm. For 80 mm maxi thickness door and lock.

Botones retorcido. 1 asiento. cuadrado acero de 6 mm. Para puertas y cerraduras con un espesor máximo de 80 mm.

Finition/Finsih/Acabado

Noir
Black
Negro

Designation	Boite	Colis.	Prix	Sachet	Colis.	Prix	Brochable					Colis.	Prix
							France	Euro 1	Euro 2	Euro 3	Euro 4		
BOUTON DOUBLE FER TORSADÉ carré 6 mm x 80 mm noir 1 portée	00006801	10	-	-	-	-	00206801	-	-	-	-	10	-
BOUTON DOUBLE FER TORSADÉ carré 6 mm x 80 mm 1 portée	00006800	10	-	-	-	-	00206800	-	-	-	-	10	-
BOUTON DOUBLE FER TORSADÉ carré 6 mm x 80 mm noir 1 portée	-	-	-	-	-	-	00216800	-	-	-	-	10	-

⚠ Non stocké/Non-stored/Producto no estocado - 📦 Sur stock Europe Zone 1 et Zone 2, nous consulter pour délai d'approvisionnement - 📦 Epuisement/Stock depletion/Agotamiento del stock

Poignée de porte / BEQUILLE DOUBLE FIL TORSADE

ECO



GARANTIE

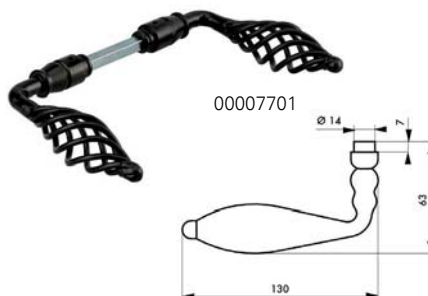
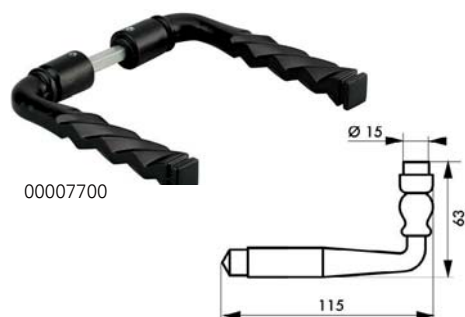

Description/Description/Descripción

Béquilles aluminium torsadé. 2 portées avec carré acier 7 mm. 1 portée avec carré acier 6 mm. Pour porte ép. 70 mm maxi. Boutons fer torsadé. 1 portée. carré acier 6 mm. Pour porte ép. 80 mm maxi. Béquilles alliage d'aluminium. 2 portées. carré inox 7 mm. Pour porte ép. 105 mm maxi.

Twisted aluminium handles. Double bossing square Simple bossing square 6 For 70maxi thickness door. Twisted iron knobs. Single bossing. Steel square 6 For 80maxi thickness door. Twisted alloy aluminium. Double bossing. square inox 7 For 105 mm maxi thickness door.

Brazos de hierro retorcido. 2 asientos de cuadrado acero de 71 asiento de cuadrado acero de 6 Para puertas con un espesor máximo de 70 Botones de hierro retorcido. 1 asiento. cuadrado acero de 6 Para puertas con un espesor máximo de 80 Brazos de hierro aleación. 2 asientos. cuadrado acero inoxidable de 7 Para puertas con un espesor máximo de 105 mm.

Finition/Finsih/Acabado

Laqué noir
Black lacquered
Lacado negro

Designation	Boite	Colis.	Prix	Sachet	Colis.	Prix	Brochable					Colis.	Prix
							France	Euro 1	Euro 2	Euro 3	Euro 4		
BEQUILLE DOUBLE ALU TORSADA carré 6x 801 portée	00007790	10	-	00907790	10	-	00207790	-	-	-	-	10	-
BEQUILLE DOUBLE ALU TORSADA carré 7 mm x 70 mm 2 portées	00007700	10	-	-	-	-	00207700	-	-	-	-	10	-
BEQUILLE DOUBLE ALU TORSADA " 7 mm x 70 mm avec fourreau adaptateur 8 mm	-	-	-	-	-	-	00217700	-	-	-	-	10	-
BEQUILLE DOUBLE ALU carré 7 mm inox x 105 mm	00039203	10	-	-	-	-	-	-	-	-	-	-	-
BEQUILLE DOUBLE FIL TORSADA carré 7 mm x 70 mm noir 2 portées	00007701	10	-	-	-	-	00207701	-	-	-	-	10	-
BEQUILLE DOUBLE FIL TORSADA carré 6 mm x 80 mm noir 1 portée	00007791	10	-	-	-	-	00207791	-	-	-	-	10	-

Non stocké/Non-stored/Producto no estocado - Sur stock Europe Zone 1 et Zone 2, nous consulter pour délai d'approvisionnement - Epuement/Stock depletion/Agotamiento del stock



PLAQUE DE PROPLETE FER noire

ECO



GARANTIE

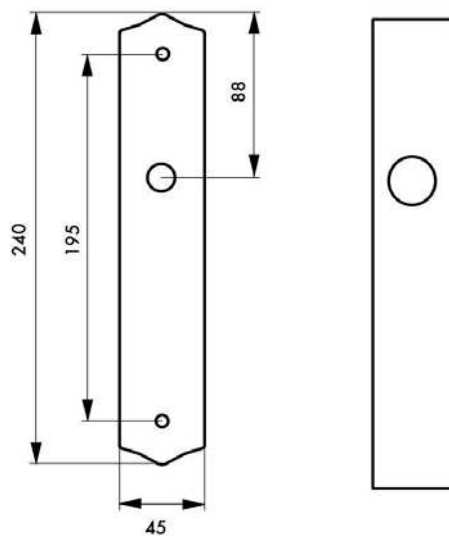

Version/Option/Versión

Avec trou de béquille. Avec trou de béquille et trou de clé. Avec trou de béquille et trou de cylindre européen. Avec trou de béquille et bouton de condamnation. Avec trou de béquille et trou de décondamnation.
 With handle hole. With handle hole and keyhole. With handle hole and european keyhole. With handle hole and locking knob. With handle hole and unlocking hole.
 Con orificio de brazo. Con orificio de brazo y orificio de llave. Con orificio de brazo y orificio de cilindro europeo. Con orificio de brazo y botón de condenación. Con orificio de brazo y orificio de descondenación.

Designation	Boite	Colis.	Prix	Sachet	Colis.	Prix	Brochable					Colis.	Prix
							France	Euro 1	Euro 2	Euro 3	Euro 4		
PLAQUE DE PROPLETE FER sans trou noir	-	-	-	-	-	-	00404400	-	-	-	-	10	-
PLAQUE DE PROPLETE FER à condamnation noir	-	-	-	-	-	-	00404401	-	-	-	-	10	-
PLAQUE DE PROPLETE FER avec trou de décondamnation noir	-	-	-	-	-	-	00404411	-	-	-	-	10	-
PLAQUE DE PROPLETE FER trou de cylindre noir	-	-	-	-	-	-	00404403	-	-	-	-	10	-
PLAQUE DE PROPLETE FER trou de clé noir	-	-	-	-	-	-	00404402	-	-	-	-	10	-
PLAQUE DE PROPLETE ALU trou de cylindre	00039201	10	-	-	-	-	-	-	-	-	-	-	-

⚠ Non stocké/Non-stored/Producto no estocado - 📦 Sur stock Europe Zone 1 et Zone 2, nous consulter pour délai d'approvisionnement - 📦 Epuisement/Stock depletion/Agotamiento del stock

PLAQUE DE PROPLETE FER noire ECO



GARANTIE

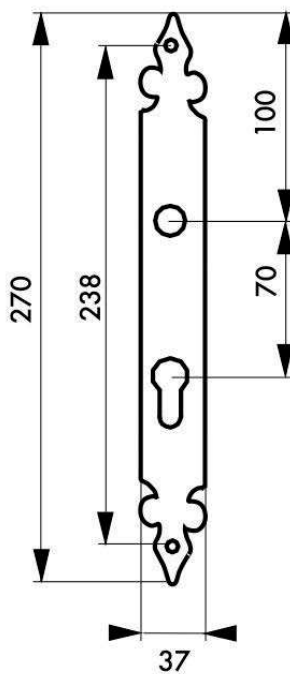

Description/Description/Descripción

Plaque de propreté fer
Iron cover plate
Placa de limpieza de hierro

Finition/Finsih/Acabado

Noir
Black
Hierro negro



Poignée de porte laiton patiné / ARTHEMIS

ECO



GARANTIE

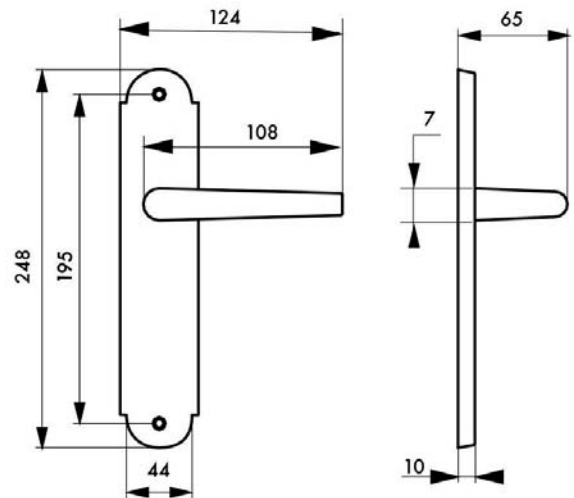

Description/Description/Descripción

Plaques acier embouti. Béquilles alliage fondu. carré acier 7 mm. Vis métaux sécables. Entr'axe de fixation 195 mm.

Steel plates. Cast alloy handles. Steel square spindle 7 mm. Metal screws.

Placas de acero embutido. Brazos de aleación fundida cuadrado acero de 7 mm. Tornillos para metal.

Finition/Finsih/Acabado

Laiton patiné

Antique brass

Latón antiguo

Version/Option/Versión

Sans trou pour porte intérieure. Avec bouton de condamnation pour porte de salle de bains et W-C. Avec trou de clé pour porte intérieure. Avec trou de cylindre européen pour porte extérieure.

Without hole for inside door. With locking knob for bathroom doors and WC. With key hole for inside door. With european cylinder hole for entrance door.

Sin orificio para puerta interior. Con botón de condensación para puerta de cuartos de baño y WC. Con orificio de llave para puerta interior. Con orificio de cilindro europeo para puerta exterior.

Designation	Boite	Colis.	Prix	Sachet	Colis.	Prix	Brochable					Colis.	Prix
							France	Euro 1	Euro 2	Euro 3	Euro 4		
Arthemis sans trou BdC	-	-	-	00943350	6	-	00543350	-	-	-	-	5	-
Arthemis trou de clé, L	-	-	-	00943352	6	-	00543352	-	-	-	-	5	-
Arthemis trou de cylindre, l	-	-	-	00943353	6	-	00543353	-	-	-	-	5	-
Arthemis à condamnation	-	-	-	00943351	6	-	00543351	-	-	-	-	5	-

Poignée de porte nickelé satiné / ATHENA

PROTECT



GARANTIE

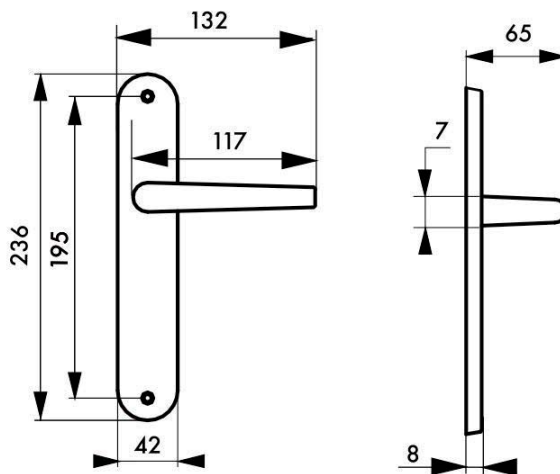

Description/Description/Descripción

Plaques acier embouti. Béquilles alliage fondu. carré acier 7 mm. Vis métaux sécables. Entr'axe de fixation 195 mm.

Steel plates. Cast alloy handles. Steel spindle 7 mm. Metal screws.

Placas de acero embutido. Brazos de aleación fundida acero de 7 mm. Tornillos para metal.

Finition/Finsih/Acabado

Nickelé satiné SN

Nickel brushed

Niquel Cepillado

Version/Option/Versión

Sans trou pour porte intérieure. Avec bouton de condamnation pour porte de salle de bains et W-C. Avec trou de clé pour porte intérieure. Avec trou de cylindre européen pour porte extérieure.

Without hole for inside door. With locking knob for bathroom doors and WC. With key hole for inside door. With european cylinder hole for entrance door.

Sin orificio para puerta interior. Con botón de condensación para puerta de cuartos de baño y WC. Con orificio de llave para puerta interior. Con orificio de cilindro europeo para puerta exterior.

Designation	Boite	Colis.	Prix	Sachet	Colis.	Prix	Brochable					Colis.	Prix
							France	Euro 1	Euro 2	Euro 3	Euro 4		
ATHENA sans trou BdC	-	-	-	00943340	6	-	00543340	-	-	-	-	5	-
ATHENA trou de clé, L	-	-	-	00943342	6	-	00543342	-	-	-	-	5	-
ATHENA trou de cylindre, I	-	-	-	00943343	6	-	00543343	-	-	-	-	5	-
ATHENA à condamnation	-	-	-	00943341	6	-	00543341	-	-	-	-	5	-

Non stocké/Non-stored/Producto no estocado - Sur stock Europe Zone 1 et Zone 2, nous consulter pour délai d'approvisionnement - Epuement/Stock depletion/Agotamiento del stock



Poignée de porte nickelé brossé / HELIOS

PROTECT



GARANTIE

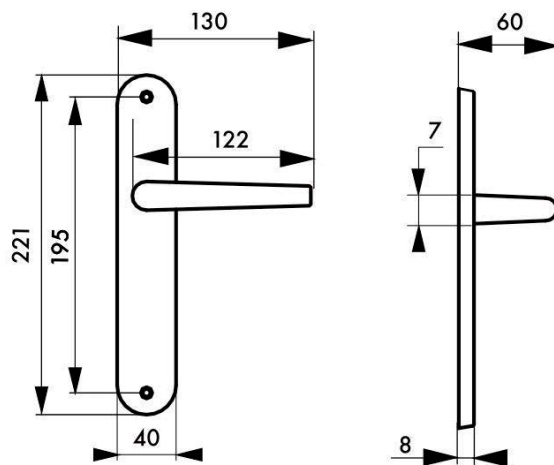

Description/Description/Descripción

Plaques acier embouti. Béquilles aluminium fondu. carré acier 7 mm. Ressort de rappel. Vis métaux sécables. Entr'axe de fixation 195 mm.

Steel plates. Cast aluminium handles. Steel spindle 7 mm. With spring. Metal screws.

Placas de acero embutido. Brazos de aluminio fundida acero de 7 mm. Com muelle. Tornillos para metal.

Finition/Finish/Acabado

Nickelé satiné

Satin nickel

Niquel satinado

Version/Option/Versión

Sans trou pour porte intérieure. Avec bouton de condamnation pour porte de salle de bains et W-C. Avec trou de clé pour porte intérieure et extérieure. Avec trou de cylindre européen pour porte extérieure.

Without hole for inside door. With locking knob for bathroom doors and WC. With key hole for inside door and entrance door. With european cylinder hole for entrance door.

Sin orificio para puerta interior. Con botón de condanación para puerta de cuartos de baño y WC. Con orificio de llave para puerta interior y exterior. Con orificio de cilindro europeo para puerta exterior.

Designation	Boite	Colis.	Prix	Sachet	Colis.	Prix	Brochable					Colis.	Prix
							France	Euro 1	Euro 2	Euro 3	Euro 4		
HELIOS sans trou BdC	-	-	-	00943410	6	-	00543410	-	-	-	-	5	-
HELIOS trou de clé, L	-	-	-	00943412	6	-	00543412	-	-	-	-	5	-
HELIOS trou de cylindre, l	-	-	-	00943413	6	-	00543413	-	-	-	-	5	-
HELIOS à condamnation	-	-	-	00943411	6	-	00543411	-	-	-	-	5	-

⚠ Non stocké/Non-stored/Producto no estocado - 📦 Sur stock Europe Zone 1 et Zone 2, nous consulter pour délai d'approvisionnement - 📦 Epuisement/Stock depletion/Agotamiento del stock

Poignée de porte nickelé satiné / HERA

PROTECT



GARANTIE

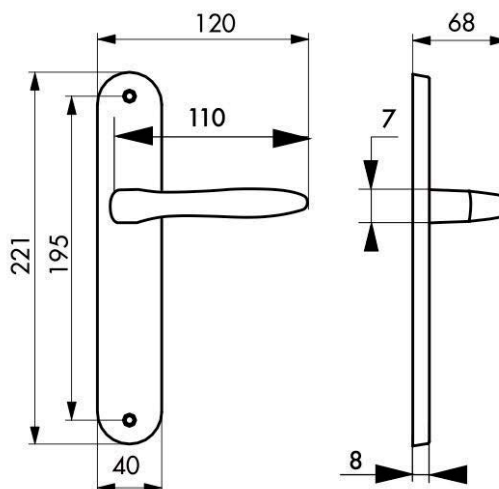

Description/Description/Descripción

Plaques acier embouté. Béquilles alliage fondu. Carré acier 7 mm. Ressort de rappel. Vis métaux. Entraxe de fixation 195 mm. *Steel plates. Cast alloy handles. Steel spindle 7 mm. With spring. Metal screws.*

Placas de acero embutido. Brazos de aleación fundida acero de 7 mm. Com muelle. Tornillos para metal.

Finition/Finish/Acabado

Nickelé satiné.

Satin nickel.

Niquel satinado.

Version/Option/Versión

Sans trou pour porte intérieure. Avec bouton de condamnation pour porte de salle de bains et W-C. Avec trou de clé pour porte intérieure. Avec trou de cylindre européen pour porte extérieure.

Without hole for inside door. With locking knob for bathroom doors and WC. With key hole for inside door. With european cylinder hole for entrance door.

Sin orificio para puerta interior. Con botón de condensación para puerta de cuartos de baño y WC. Con orificio de llave para puerta interior. Con orificio de cilindro europeo para puerta exterior.

Designation	Boite	Colis.	Prix	Sachet	Colis.	Prix	Brochable					Colis.	Prix
							France	Euro 1	Euro 2	Euro 3	Euro 4		
HERA sans trou BdC	-	-	-	00990370	6	-	00590370	-	-	-	-	5	-
HERA trou de clé, L	-	-	-	00990372	6	-	00590372	-	-	-	-	5	-
HERA trou de cylindre, l	-	-	-	00990373	6	-	00590373	-	-	-	-	5	-
HERA à condamnation	-	-	-	00990371	6	-	00590371	-	-	-	-	5	-

Non stocké/Non-stored/Producto no estocado - Sur stock Europe Zone 1 et Zone 2, nous consulter pour délai d'approvisionnement - Epuement/Stock depletion/Agotamiento del stock



Poignée de porte nickelé satiné / THALIA

PROTECT



GARANTIE

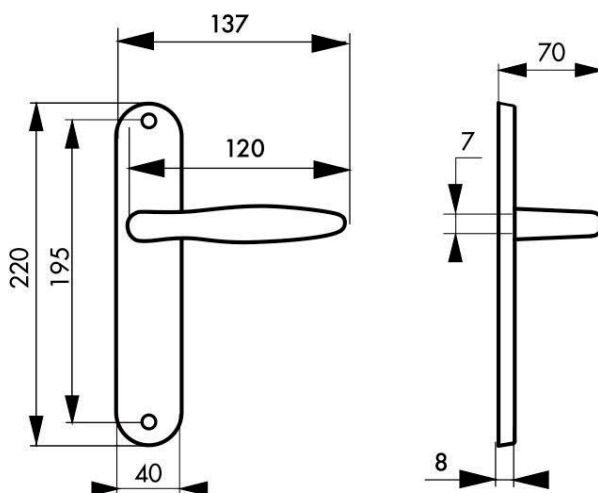
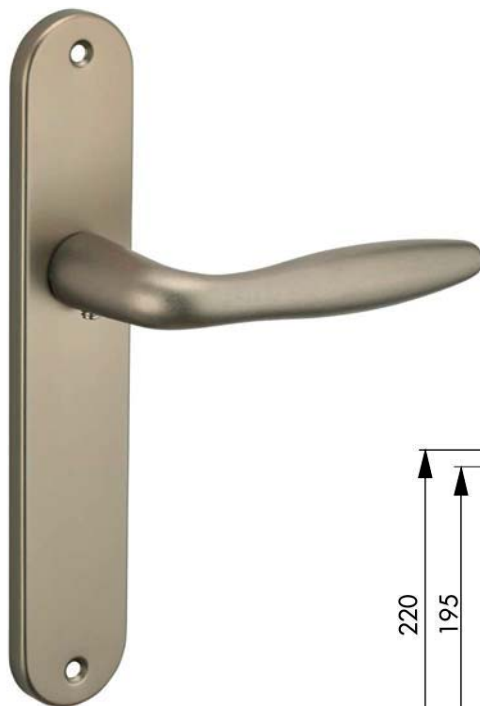

Description/Description/Descripción

Plaques acier embouti. Béquilles alliage fondu. Carré acier 7 mm métaux . Entraxe de fixation 195 mm.

Steel plates. Cast alloy handles. Steel spindle 7 mm. Metal screws.

Placas de acero embutido. Brazos de aleación fundida acero de 7 mm. Tornillos para metal.

Finition/Finish/Acabado

Nickelé satiné.

Satin nickel.

Niquel satinado.

Version/Option/Versión

Sans trou pour porte intérieure. Avec bouton de condamnation pour porte de salle de bains et W-C. Avec trou de clé pour porte intérieure. Avec trou de cylindre européen pour porte extérieure.

Without hole for inside door. With locking knob for bathroom doors and WC. With key hole for inside door. With european cylinder hole for entrance door.

Sin orificio para puerta interior. Con botón de condensación para puerta de cuartos de baño y WC. Con orificio de llave para puerta interior. Con orificio de cilindro europeo para puerta exterior.

Designation	Boite	Colis.	Prix	Sachet	Colis.	Prix	Brochable					Colis.	Prix
							France	Euro 1	Euro 2	Euro 3	Euro 4		
THALIA sans trou BdC	-	-	-	00990374	6	-	-	-	-	-	-	-	-
THALIA trou de clé, L	-	-	-	00990376	6	-	-	-	-	-	-	-	-
THALIA trou de cylindre, l	-	-	-	00990377	6	-	-	-	-	-	-	-	-
THALIA à condamnation	-	-	-	00990375	6	-	-	-	-	-	-	-	-

⚠ Non stocké/Non-stored/Producto no estocado - ☑ Sur stock Europe Zone 1 et Zone 2, nous consulter pour délai d'approvisionnement - ☒ Epuisement/Stock depletion/Agotamiento del stock

Poignée de porte CHARON

PROTECT



GARANTIE

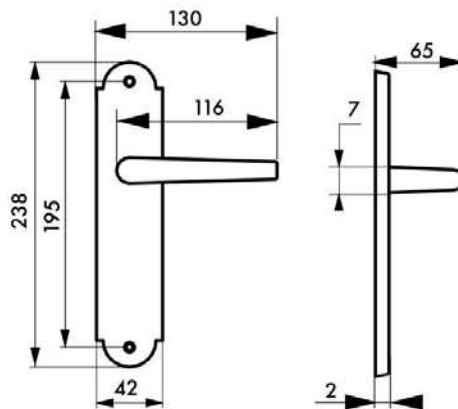

Description/Description/Descripción

Plaques acier. Béquilles alliage fondu. carré acier 7 mm. Vis métaux sécables. Entr'axe de fixation 195 mm.

Steel plates. Cast alloy handles. Steel spindle 7 mm. Metal screws.

Placas de acero. Brazos de aleación fundida acero de 7 mm. Tornillos para metal.

Finition/Finsih/Acabado

Acier rouillé / acier patiné

Rust finishing / patinated steel

Acero oxidado / acero patinado

Version/Option/Versión

Sans trou pour porte intérieure. Avec bouton de condamnation pour porte de salle de bains et W-C. Avec trou de clé pour porte intérieure. Avec trou de cylindre européen pour porte extérieure.

Without hole for inside door. With locking knob for bathroom doors and WC. With key hole for inside door. With european cylinder hole for entrance door.

Sin orificio para puerta interior. Con botón de condena- ción para puerta de cuartos de baño y WC. Con orificio de llave para puerta interior. Con orificio de cilindro europeo para puerta exterior.

Designation	Boite	Colis.	Prix	Sachet	Colis.	Prix	Brochable					Colis.	Prix
							France	Euro 1	Euro 2	Euro 3	Euro 4		
CHARON sans trou BdC acier rouillé	-	-	-	00943380	6	-	00543380	-	-	-	-	5	-
CHARON trou de clé, L acier rouillé	-	-	-	00943382	6	-	00543382	-	-	-	-	5	-
CHARON trou de cylindre, I acier rouillé	-	-	-	00943383	6	-	00543383	-	-	-	-	5	-
CHARON à condamnation acier rouillé	-	-	-	00943381	6	-	00543381	-	-	-	-	5	-
CHARON sans trou BdC acier patiné	-	-	-	00943384	6	-	00543384	-	-	-	-	5	-
CHARON trou de clé, L acier patiné	-	-	-	00943386	6	-	00543386	-	-	-	-	5	-
CHARON trou de cylindre, I acier patiné	-	-	-	00943387	6	-	00543387	-	-	-	-	5	-
CHARON à condamnation acier patiné	-	-	-	00943385	6	-	00543385	-	-	-	-	5	-

Non stocké/Non-stored/Producto no estocado - Sur stock Europe Zone 1 et Zone 2, nous consulter pour délai d'approvisionnement - Epuement/Stock depletion/Agotamiento del stock



Poignée de porte laitonné / DIONYSOS

PROTECT



GARANTIE

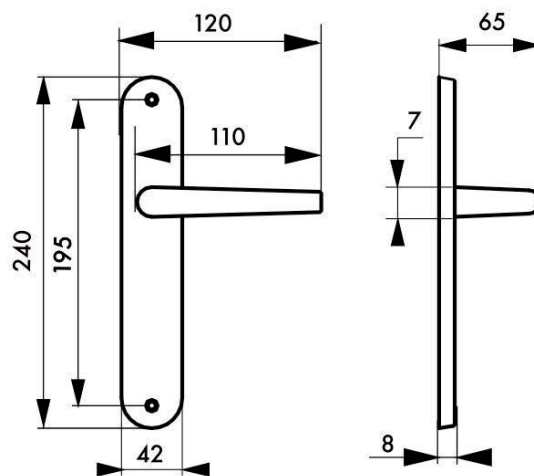

Description/Description/Descripción

Plaques acier embouti. Béquilles alliage fondu. carré acier 7 mm. Ressort de rappel. Vis métaux sécables. Entr'axe de fixation 195 mm.

Steel plates. Cast alloy handles. Steel spindle 7 mm. With spring. Metal screws.

Placas de acero embutido. Brazos de aleación fundida acero de 7 mm. Com muelle. Tornillos para metal.

Finition/Finish/Acabado

Laitonné

Brass plated steel

Latonado

Version/Option/Versión

Sans trou pour porte intérieure. Avec bouton de condamnation pour porte de salle de bains et W-C. Avec trou de clé pour porte intérieure. Avec trou de cylindre européen pour porte extérieure.

Without hole for inside door. With locking knob for bathroom doors and WC. With key hole for inside door. With european cylinder hole for entrance door.

Sin orificio para puerta interior. Con botón de condena-ción para puerta de cuartos de baño y WC. Con orificio de llave para puerta interior. Con orificio de cilindro europeo para puerta exterior.

Designation	Boite	Colis.	Prix	Sachet	Colis.	Prix	Brochable					Colis.	Prix
							France	Euro 1	Euro 2	Euro 3	Euro 4		
DIONYSOS sans trou BdC	-	-	-	00943330	6	-	00543330	-	-	-	-	5	-
DIONYSOS trou de clé, L	-	-	-	00943332	6	-	00543332	-	-	-	-	5	-
DIONYSOS trou de cylindre, I	-	-	-	00943333	6	-	00543333	-	-	-	-	5	-
DIONYSOS à condamnation	-	-	-	00943331	6	-	00543331	-	-	-	-	5	-

⚠ Non stocké/Non-stored/Producto no estocado - 📦 Sur stock Europe Zone 1 et Zone 2, nous consulter pour délai d'approvisionnement - 📦 Epuisement/Stock depletion/Agotamiento del stock

Poignée de porte nickelé brossé / ERIS

RESIST



GARANTIE

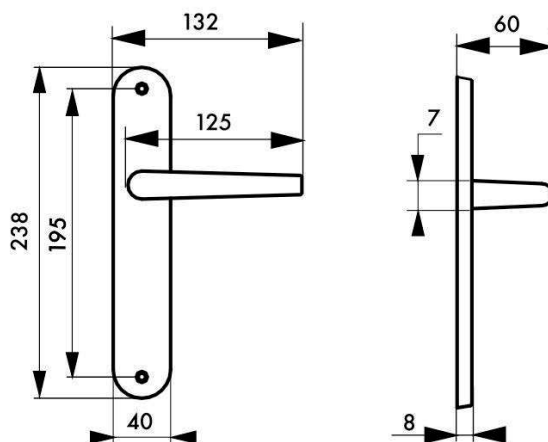

Description/Description/Descripción

Plaques acier embouté. Béquilles alliage fondu. carré acier 7 mm. Ressort de rappel. Vis métaux sécables. Entr'axe de fixation 195 mm.

Steel plates. Cast alloy handles. Steel spindle 7 mm. With spring. Metal screws.

Placas de acero embutido. Brazos de aleación fundida acero de 7 mm. Com muelle. Tornillos para metal.

Finition/Finish/Acabado

Nickelé satiné

Satin nickel

Niquel satinado

Version/Option/Versión

Sans trou pour porte intérieure. Avec bouton de condamnation pour porte de salle de bains et W-C. Avec trou de clé pour porte intérieure et extérieure. Avec trou de cylindre européen pour porte extérieure.

Without hole for inside door. With locking knob for bathroom doors and WC. With key hole for inside door and entrance door. With european cylinder hole for entrance door.

Sin orificio para puerta interior. Con botón de condensación para puerta de cuartos de baño y WC. Con orificio de llave para puerta interior y exterior. Con orificio de cilindro europeo para puerta exterior.

Designation	Boite	Colis.	Prix	Sachet	Colis.	Prix	Brochable					Colis.	Prix
							France	Euro 1	Euro 2	Euro 3	Euro 4		
Eris sans trou BdC	-	-	-	00943390	6	-	00543390	-	-	-	-	5	-
Eris trou de clé, L	-	-	-	00943392	6	-	00543392	-	-	-	-	5	-
Eris trou de cylindre, l	-	-	-	00943393	6	-	00543393	-	-	-	-	5	-
Eris à condamnation	-	-	-	00943391	6	-	00543391	-	-	-	-	5	-

Non stocké/Non-stored/Producto no estocado - Sur stock Europe Zone 1 et Zone 2, nous consulter pour délai d'approvisionnement - Epuement/Stock depletion/Agotamiento del stock



Poignée de porte nickelé brossé / GAIA

RESIST



GARANTIE

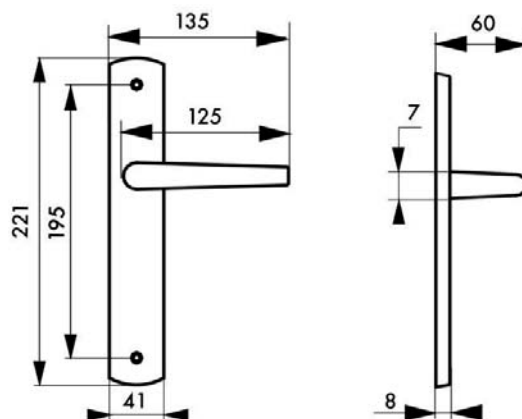

Description/Description/Descripción

Plaques acier embouti. Béquilles alliage fondu. Carré acier 7 mm. Ressort de rappel. Vis métaux sécables. Entraxe de fixation 195 mm.

Steel plates. Cast alloy handles. Steel spindle 7 mm. With spring. Metal screws.

Placas de acero embutido. Brazos de aleación fundida acero de 7 mm. Com muelle. Tornillos para metal.

Finition/Finsih/Acabado

Nickelé brossé

Nickel brushed

Niquel cepillado

Version/Option/Versión

Sans trou pour porte intérieure. Avec bouton de condamnation pour porte de salle de bains et W-C. Avec trou de clé pour porte intérieure. Avec trou de cylindre européen pour porte extérieure.

Without hole for inside door. With locking knob for bathroom doors and WC. With key hole for inside door. With european cylinder hole for entrance door.

Sin orificio para puerta interior. Con botón de condensación para puerta de cuartos de baño y WC. Con orificio de llave para puerta interior. Con orificio de cilindro europeo para puerta exterior.

Designation	Boite	Colis.	Prix	Sachet	Colis.	Prix	Brochable					Colis.	Prix
							France	Euro 1	Euro 2	Euro 3	Euro 4		
Gaia sans trou Bdc	-	-	-	00943400	6	-	00543400	-	-	-	-	5	-
Gaia trou de clé, L	-	-	-	00943402	6	-	00543402	-	-	-	-	5	-
Gaia trou de cylindre, l	-	-	-	00943403	6	-	00543403	-	-	-	-	5	-
Gaia à condamnation	-	-	-	00943401	6	-	00543401	-	-	-	-	5	-

⚠ Non stocké/Non-stored/Producto no estocado - 📦 Sur stock Europe Zone 1 et Zone 2, nous consulter pour délai d'approvisionnement - 🇪🇺 Epuisement/Stock depletion/Agotamiento del stock

Poignée de porte argent / PELOPE

ECO



GARANTIE

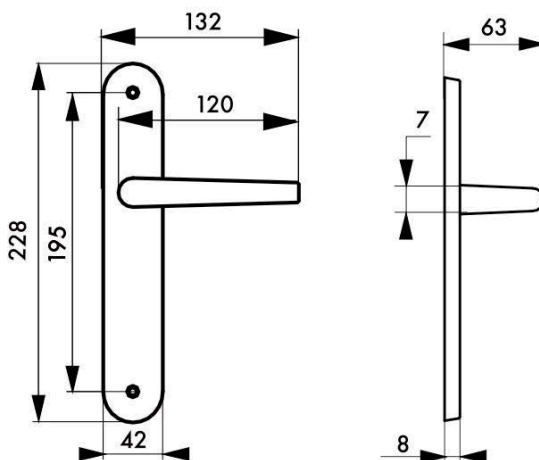

Description/Description/Descripción

Plaques aluminium embouties. Béquilles aluminium.

Carré acier 7 mm.

Aluminium plates. Cast aluminium handles. Steel square spindle 7 mm.

Placas de aluminio embutido. Brazos de aluminio. Cuadrado acero de 7 mm.

Finition/Finish/Acabado

Argent F1

Silver

Plata

Version/Option/Versión

Sans trou pour porte intérieure. Avec bouton de condamnation pour porte de salle de bains et W-C. Avec trou de

clé pour porte intérieure. Avec trou de cylindre européen pour porte extérieure.

Without hole for inside door. With locking knob for bathroom doors and WC. With key hole for inside door. With european cylinder hole for entrance door.

Sin orificio para puerta interior. Con botón de condensación para puerta de cuartos de baño y WC. Con orificio de llave para puerta interior. Con orificio de cilindro europeo para puerta exterior.

Utilisation/Use/Utilización

Pour porte épaisseur 38-43mm

For 38-43mm door thickness

Para puerta de 38-43 mm

Designation	Boite	Colis.	Prix	Sachet	Colis.	Prix	Brochable					Colis.	Prix
							France	Euro 1	Euro 2	Euro 3	Euro 4		
PELOPE sans trou BdC	00066736	10	-	-	-	-	00566736	-	-	-	-	10	-
PELOPE trou de clé, L	00066739	10	-	-	-	-	00566739	-	-	-	-	10	-
PELOPE trou de cylindre, I	00066740	10	-	-	-	-	00566740	-	-	-	-	10	-
PELOPE à condamnation	00066737	10	-	-	-	-	00566737	-	-	-	-	10	-

Non stocké/Non-stored/Producto no estocado - Sur stock Europe Zone 1 et Zone 2, nous consulter pour délai d'approvisionnement - Epuement/Stock depletion/Agotamiento del stock



Poignée de porte Chromé satin / GOCCIA

PROTECT



GARANTIE

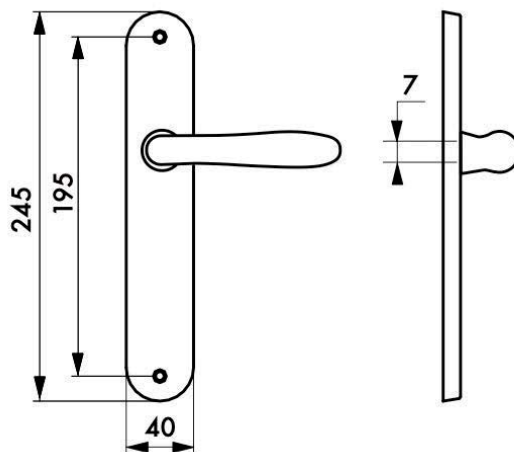

Description/Description/Descripción

Plaques aluminium embouti. Béquilles aluminium. Carré acier 7mm. Vis métaux. Pour porte ép. 45mm maxi. Entraxe de fixation 195mm.

Aluminium plates. Cast aluminium handles. Steel square spindle 7mm. Metal screws. Mounting distance 195mm. Placas de aluminio embutido. Brazos de aluminio fundida. Cuadrado de acero de 7mm. Tornillos metálicos. Distancia de montaje 195mm.

Finition/Finish/Acabado

Chromé satin.

Satin chrome.

. Cromado satinado.

Version/Option/Versión

Sans trou pour porte intérieure. Avec bouton de condamnation pour porte de salle de bains et W-C. Avec trou de clé pour porte intérieure. Avec trou de cylindre européen pour porte extérieure.

Without hole for inside door. With locking knob for bathroom doors and WC. With key hole for inside door. With european cylinder hole for entrance door.

Sin orificio para puerta interior. Con botón de condonación para puerta de cuartos de baño y WC. Con orificio de llave para puerta interior. Con orificio de cilindro europeo para puerta exterior.

Designation	Boite	Colis.	Prix	Sachet	Colis.	Prix	Brochable					Colis.	Prix
							France	Euro 1	Euro 2	Euro 3	Euro 4		
Ensemble poignée GOCCIA E195 sans trou, chromé satin	-	-	-	00966765	1	-	-	-	-	-	-	-	-
Ensemble poignée GOCCIA E195 trou de clé, L - chromé satin	-	-	-	00966767	1	-	-	-	-	-	-	-	-
Ensemble poignée GOCCIA E195 trou de cylindre, L - chromé satin	-	-	-	00966768	1	-	-	-	-	-	-	-	-
Ensemble poignée GOCCIA E195 à condamnation, chromé satin	-	-	-	00966766	1	-	-	-	-	-	-	-	-

⚠ Non stocké/Non-stored/Producto no estocado - 📦 Sur stock Europe Zone 1 et Zone 2, nous consulter pour délai d'approvisionnement - 📦 Epuisement/Stock depletion/Agotamiento del stock

Poignée de porte nickelé satiné / SELENE

ECO



GARANTIE

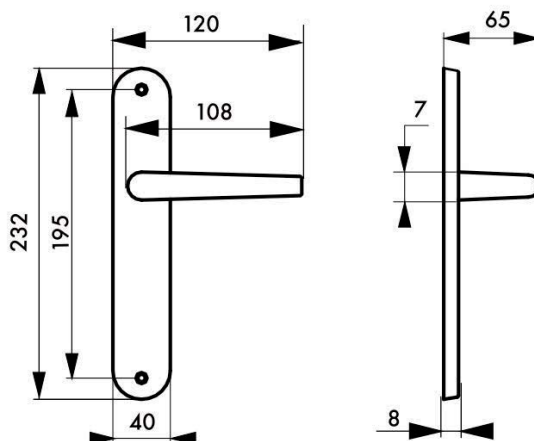

Description/Description/Descripción

Plaques aluminium embouti. Béquilles aluminium fondu. Carré acier 7Ressort de rappel. Vis métaux sécables. Entraxe de fixation 195 mm.

Aluminium plates. Cast Aluminium handles. Steel square spindle 7 mm. With spring. Metal screws.

Placas de aluminio embutido. Brazos de aluminio fundida cuadrado acero de 7 mm. Com muelle. Tornillos para metal.

Finition/Finsih/Acabado

Nickelé satiné

Satin nickel

Niquel satinado

Version/Option/Versión

Sans trou pour porte intérieure. Avec bouton de condamnation pour porte de salle de bains et W-C. Avec trou de clé pour porte intérieure. Avec trou de cylindre européen pour porte extérieure.

Without hole for inside door. With locking knob for bathroom doors and WC. With key hole for inside door. With european cylinder hole for entrance door.

Sin orificio para puerta interior. Con botón de condena- ción para puerta de cuartos de baño y WC. Con orificio de llave para puerta interior. Con orificio de cilindro europeo para puerta exterior.

Designation	Boite	Colis.	Prix	Sachet	Colis.	Prix	Brochable					Colis.	Prix
							France	Euro 1	Euro 2	Euro 3	Euro 4		
SELENE sans trou BdC	-	-	-	00990230	6	-	00590230	-	-	-	-	5	-
SELENE trou de clé, L	-	-	-	00990232	6	-	00590232	-	-	-	-	5	-
SELENE trou de cylindre, l	-	-	-	00990233	6	-	00590233	-	-	-	-	5	-
SELENE à condamnation	-	-	-	00990231	6	-	00590231	-	-	-	-	5	-

Non stocké/Non-stored/Producto no estocado - Sur stock Europe Zone 1 et Zone 2, nous consulter pour délai d'approvisionnement - Epuement/Stock depletion/Agotamiento del stock



Poignée de porte nickelé satiné / VESTA

ECO



GARANTIE

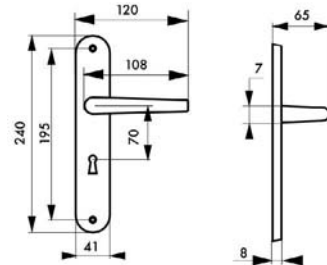
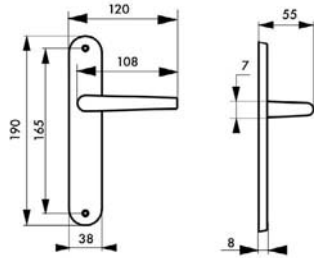

Description/Description/Descripción

Plaques aluminium embouti. Béquilles aluminium fondu, carré acier 7Vis métaux sécables. Entraxe de fixation 165 mm ou 195mm.

Aluminium plates. Cast Aluminium handles. Steel square spindle 7 mm. Metal screws.

Placas de aluminio embutido. Brazos de aluminio fundida cuadrado acero de 7 mm. Tornillos para metal.

Finition/Finish/Acabado

Nickelé satiné

Satin nickel

Niquel satinado

Version/Option/Versión

Sans trou pour porte intérieure. Avec bouton de condamnation pour porte de salle de bains et W-C. Avec trou de clé pour porte intérieure. Avec trou de cylindre européen pour porte extérieure.

Without hole for inside door. With locking knob for bathroom doors and WC. With key hole for inside door. With european cylinder hole for entrance door.

Sin orificio para puerta interior. Con botón de condensación para puerta de cuartos de baño y WC. Con orificio de llave para puerta interior. Con orificio de cilindro europeo para puerta exterior.

Designation	Boite	Colis.	Prix	Sachet	Colis.	Prix	Brochable					Colis.	Prix
							France	Euro 1	Euro 2	Euro 3	Euro 4		
VESTA sans trou BdC entr'axes 165mm	-	-	-	00990351	6	-	00590351	-	-	-	-	5	-
VESTA trou de clé, L entr'axes 165mm	-	-	-	00990353	6	-	00590353	-	-	-	-	5	-
VESTA trou de cylindre, I entr'axes 165mm	-	-	-	00990354	6	-	00590354	-	-	-	-	5	-
VESTA à condamnation entr'axes 165mm	-	-	-	00990352	6	-	00590352	-	-	-	-	5	-
VESTA sans trou BdC entr'axes 195mm	-	-	-	00990355	6	-	00590355	-	-	-	-	5	-
VESTA trou de clé, L entr'axes 195mm	-	-	-	00990357	6	-	00590357	-	-	-	-	5	-
VESTA trou de cylindre, I entr'axes 195mm	-	-	-	00990358	6	-	00590358	-	-	-	-	5	-
VESTA à condamnation entr'axes 195mm	-	-	-	00990356	6	-	00590356	-	-	-	-	5	-

⚠ Non stocké/Non-stored/Producto no estocado - 📦 Sur stock Europe Zone 1 et Zone 2, nous consulter pour délai d'approvisionnement - 📦 Epuisement/Stock depletion/Agotamiento del stock

Poignée de porte nickelé brossé / DIANE

RESIST



GARANTIE

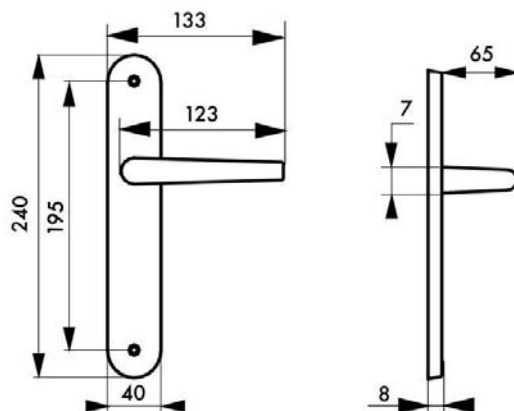

Description/Description/Descripción

Plaques acier embouti. Béquilles alliage fondu. carré acier 7 mm. Ressort de rappel. Vis métaux sécables. Entr'axe de fixation 195 mm.

Steel plates. Cast alloy handles. Steel spindle 7 mm. With spring. Metal screws.

Placas de acero embutido. Brazos de aleación fundida acero de 7 mm. Com muelle. Tornillos para metal.

Finition/Finish/Acabado

Nickelé brossé
Nickel brushed
Niquel Cepillado

Version/Option/Versión

Sans trou pour porte intérieure. Avec bouton de condamnation pour porte de salle de bains et W-C. Avec trou de clé pour porte intérieure et extérieure. Avec trou de cylindre européen pour porte extérieure.

Without hole for inside door. With locking knob for bathroom doors and WC. With key hole for inside door and entrance door. With european cylinder hole for entrance door.

Sin orificio para puerta interior. Con botón de condenación para puerta de cuartos de baño y WC. Con orificio de llave para puerta interior y exterior. Con orificio de cilindro europeo para puerta exterior.

Designation	Boite	Colis.	Prix	Sachet	Colis.	Prix	Brochable					Colis.	Prix
							France	Euro 1	Euro 2	Euro 3	Euro 4		
Diane sans trou BdC	-	-	-	00990359	6	-	00590359	-	-	-	-	5	-
Diane trou de clé, L	-	-	-	00990361	6	-	00590361	-	-	-	-	5	-
Diane trou de cylindre, l	-	-	-	00990362	6	-	00590362	-	-	-	-	5	-
Diane à condamnation	-	-	-	00990360	6	-	00590360	-	-	-	-	5	-

⚠ Non stocké/Non-stored/Producto no estocado - 📦 Sur stock Europe Zone 1 et Zone 2, nous consulter pour délai d'approvisionnement - ⚠ Epuisement/Stock depletion/Agotamiento del stock



Poignée de porte aspect inox ou blanc / SULTANE

PROTECT



GARANTIE

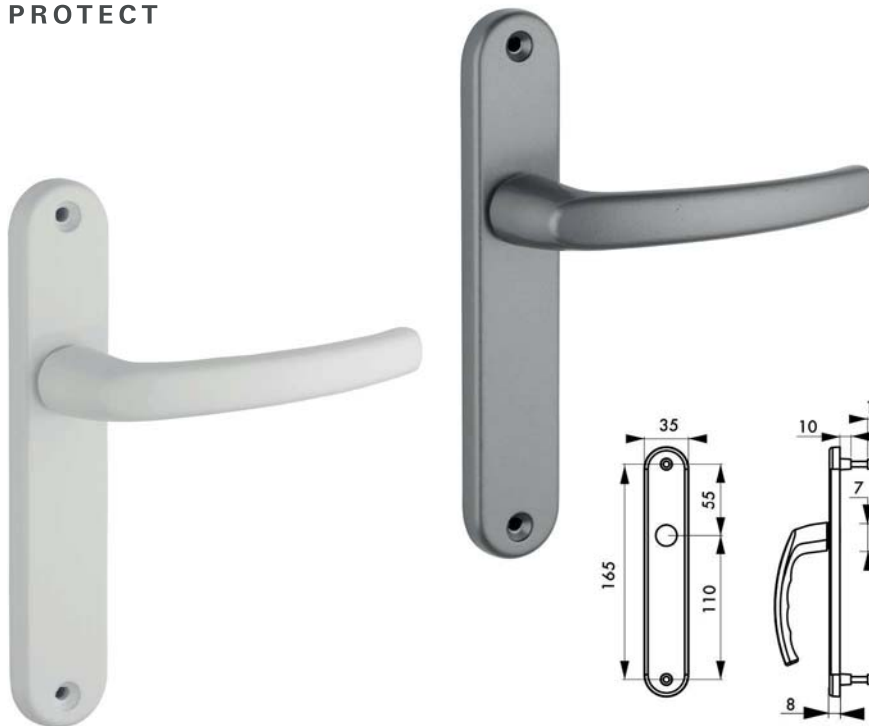

Description/Description/Descripción

Plaques aluminium fondu. Béquilles aluminium fondu. Carré acier 7 mm. Vis métaux. Pour porte ép. 50 mm maxi. Entraxe de 165mm.

Stamped aluminium plates. Cast aluminium handles. Steel Square spindle 7 mm. Metal screws. For 50 mm maxi thickness door.

Placas de aluminio embutido. Brazos de aluminio fundido. Cuadrado acero de 7 mm. Tornillos para metal de casquillo. Para puertas con un espesor mde 50 mm.

Finition/Finsih/Acabado

Blanc 9016, aspect inox F9.

White 9016, stainless steel appearance.

Blanco 9016, aspecto acero inoxidable.

Version/Option/Versión

Entraxe de xation 195mm. Sans trou pour porte int\foérieure. Avec bouton de condamnation pour porte de salle de bains et W-C. Avec trou de clé pour porte intérieure.

Avec trou de cylindre européen pour porte extérieure.

Avec trou de cylindre européen pour porte palière.

Without hole for inside door. With locking knob for bathroom doors and WC. With key hole for inside door. With european cylinder hole for entrance door. With European cylinder hole for outdoor.

Sin oricio para puerta interior. Con botde condenación para puerta de cuartos de baño y WC. Con oricio de llave para puerta interior. Con oricio de cilindro europeo para puerta exterior.

Designation	Boîte	Colis.	Prix	Sachet	Colis.	Prix	Brochable					Colis.	Prix
							France	Euro 1	Euro 2	Euro 3	Euro 4		
SULTANE sans trou BdC blanc	-	-	-	00990440	10	-	00590440	-	-	-	-	10	-
SULTANE trou de clé, L blanc	-	-	-	00990442	10	-	00590442	-	-	-	-	10	-
SULTANE trou de cylindre, l blanc	-	-	-	00990443	10	-	00590443	-	-	-	-	10	-
SULTANE à condamnation blanc	-	-	-	00990441	10	-	00590441	-	-	-	-	10	-
SULTANE sans trou BdC inox F9	-	-	-	00990444	10	-	00590444	-	-	-	-	10	-
SULTANE trou de clé, L inox F9	-	-	-	00990446	10	-	00590446	-	-	-	-	10	-
SULTANE trou de cylindre, l inox F9	-	-	-	00990447	10	-	00590447	-	-	-	-	10	-
SULTANE à condamnation inox F9	-	-	-	00990445	10	-	00590445	-	-	-	-	10	-

⚠ Non stocké/Non-stored/Producto no estocado - 📦 Sur stock Europe Zone 1 et Zone 2, nous consulter pour délai d'approvisionnement - 📦 Epuisement/Stock depletion/Agotamiento del stock

Poignée de porte argent / CRECY

PROTECT



GARANTIE

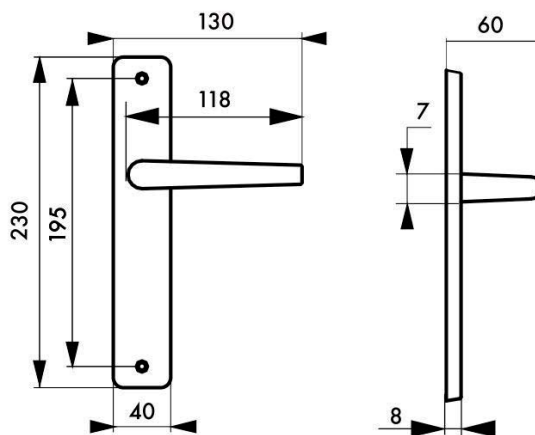

Description/Description/Descripción

Plaques aluminium fondu. Béquilles aluminium fondu. Carré acier 7Vis métaux. Pour porte ép. 45 mm maxi. Entraxe de fixation 195 mm.

Stamped aluminium plates. Cast aluminium handles. Steel square spindle 7Metal screws. For 45 mm maxi thickness door.

Placas de aluminio embutido. Brazos de aluminio fundido. cuadrado acero de 7~mm. Tornillos para metal de casquillo. Para puertas con un espesor máximo de 45mm.

Finition/Finsih/Acabado

Anodisé argent F1

Silver anodized

Anodizado plata

Version/Option/Versión

Sans trou pour porte intérieure. Avec bouton de condamnation pour porte de salle de bains et W-C. Avec trou de clé pour porte intérieure. Avec trou de cylindre européen pour porte extérieure. Avec trou de cylindre européen pour porte palière.

Without hole for inside door. With locking knob for bathroom doors and WC. With key hole for inside door. With european cylinder hole for entrance door. With European cylinder hole for outdoor.

Sin orificio para puerta interior. Con botón de condena-ción para puerta de cuartos de baño y WC. Con orificio de llave para puerta interior. Con orificio de cilindro europeo para puerta exterior.

Designation	Boite	Colis.	Prix	Sachet	Colis.	Prix	Brochable					Colis.	Prix
							France	Euro 1	Euro 2	Euro 3	Euro 4		
CRECY sans trou BdC	-	-	-	00900270	10	-	-	-	-	-	-	-	-
CRECY trou de clé, L	-	-	-	00900272	10	-	-	-	-	-	-	-	-
CRECY trou de cylindre, I	-	-	-	00900274	10	-	-	-	-	-	-	-	-
CRECY à condamnation	-	-	-	00900271	10	-	-	-	-	-	-	-	-
CRECY trou de cylindre, I pour porte palière	-	-	-	00900275	10	-	-	-	-	-	-	-	-

Non stocké/Non-stored/Producto no estocado - Sur stock Europe Zone 1 et Zone 2, nous consulter pour délai d'approvisionnement - Epuement/Stock depletion/Agotamiento del stock



Poignée de porte aspect inox ou blanc / CHANTILLY

RESIST



GARANTIE

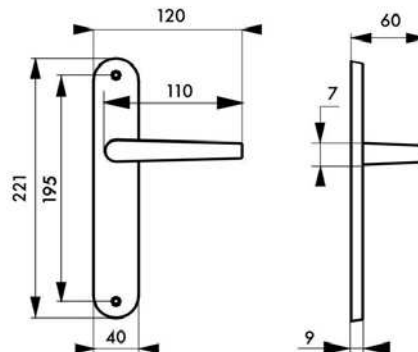

Description/Description/Descripción

Plaques aluminium fondu. Béquilles aluminium fondu. Carré acier 7Vis métaux. Pour porte ép. 45 mm maxi. Entraxe de fixation 195 mm.

Stamped aluminium plates. Cast aluminium handles. Steel square spindle 7 mm. Metal screws. For 45 mm maxi thickness door.

Placas de aluminio embutido. Brazos de aluminio fundido. cuadrado acero de 7 mm. Tornillos para metal de casquillo. Para puertas con un espesor máximo de 45 mm.

Finition/Finish/Acabado

Aspect inox F9, laqué blanc

Stainless steel anodized appearance.

Anodizado aspecto inoxidable

Version/Option/Versión

Sans trou pour porte intérieure. Avec bouton de condamnation pour porte de salle de bains et W-C. Avec trou de clé pour porte intérieure. Avec trou de cylindre européen pour porte extérieure. Avec trou de cylindre européen pour porte palière.

Without hole for inside door. With locking knob for bathroom doors and WC. With key hole for inside door. With European cylinder hole for entrance door. With European cylinder hole for outdoor.

Sin orificio para puerta interior. Con botón de condensación para puerta de cuartos de baño y WC. Con orificio de llave para puerta interior. Con orificio de cilindro europeo para puerta exterior.

Designation	Boite	Colis.	Prix	Sachet	Colis.	Prix	Brochable					Colis.	Prix
							France	Euro 1	Euro 2	Euro 3	Euro 4		
CHANTILLY anodisé inox sans trou BdC	-	-	-	00904080	10	-	00504080	-	-	-	-	10	-
CHANTILLY anodisé inox trou de clé, L	-	-	-	00904082	10	-	00504082	-	-	-	-	10	-
CHANTILLY anodisé inox trou de cylindre, I	-	-	-	00904083	10	-	00504083	-	-	-	-	10	-
CHANTILLY anodisé inox à condamnation	-	-	-	00904081	10	-	00504081	-	-	-	-	10	-
CHANTILLY anodisé inox trou de cylindre, I pour porte palière	-	-	-	00904084	10	-	00504084	-	-	-	-	10	-
CHANTILLY laqué blanc sans trou BdC	-	-	-	00904085	10	-	-	-	-	-	-	-	-
CHANTILLY laqué blanc trou de clé, L	-	-	-	00904087	10	-	-	-	-	-	-	-	-
CHANTILLY laqué blanc trou de cylindre, I	-	-	-	00904088	10	-	-	-	-	-	-	-	-
CHANTILLY laqué blanc à condamnation	-	-	-	00904086	10	-	-	-	-	-	-	-	-
CHANTILLY laqué blanc trou de cylindre, I pour porte palière	-	-	-	00904089	10	-	-	-	-	-	-	-	-

⚠ Non stocké/Non-stored/Producto no estocado - 📦 Sur stock Europe Zone 1 et Zone 2, nous consulter pour délai d'approvisionnement - 📦 Epuisement/Stock depletion/Agotamiento del stock

Poignée de porte bois / THEMIS



GARANTIE

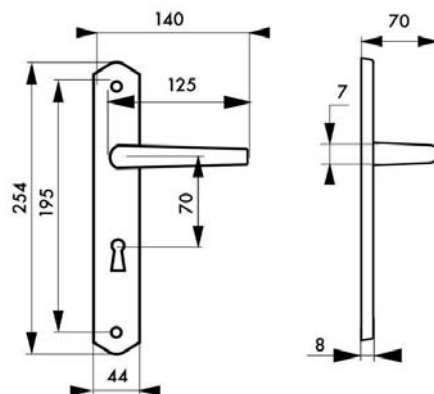

Description/Description/Descripción

Plaques bois. Béquilles bois, carré acier 7 mm. Vis métaux sécables. Entr'axe de fixation 195 mm.

Wood plates. Wood handles. Steel square spindle 7 mm. Metal screws.

Placas de madera. Brazos de madera cuadrado acero de 7 mm. Tornillos para metal.

Finition/Finish/Acabado

Bois naturel ou blanc

Natural or white wood

Natural o blanco

Version/Option/Versión

Sans trou pour porte intérieure. Avec bouton de condamnation pour porte de salle de bains et W-C. Avec trou de clé pour porte intérieure et extérieure. Avec trou de cylindre européen pour porte extérieure.

Without hole for inside door. With locking knob for bathroom doors and WC. With key hole for inside door and entrance door. With european cylinder hole for entrance door.

Sin orificio para puerta interior. Con botón de condena- ción para puerta de cuartos de baño y WC. Con orificio de llave para puerta interior y exterior. Con orificio de cilindro europeo para puerta exterior.

Designation	Boîte	Colis.	Prix	Sachet	Colis.	Prix	Brochable					Colis.	Prix
							France	Euro 1	Euro 2	Euro 3	Euro 4		
THEMIS sans trou BdC brut	-	-	-	00900970	6	-	-	-	-	-	-	-	-
THEMIS trou de clé, L brut	-	-	-	00900972	6	-	-	-	-	-	-	-	-
THEMIS trou de cylindre, l brut	-	-	-	00900973	6	-	-	-	-	-	-	-	-
THEMIS à condamnation brut	-	-	-	00900971	6	-	-	-	-	-	-	-	-
THEMIS sans trou BdC blanc	-	-	-	00902970	6	-	-	-	-	-	-	-	-
THEMIS trou de clé, L blanc	-	-	-	00902972	6	-	-	-	-	-	-	-	-
THEMIS trou de cylindre, l blanc	-	-	-	00902973	6	-	-	-	-	-	-	-	-
THEMIS à condamnation blanc	-	-	-	00902971	6	-	-	-	-	-	-	-	-

Non stocké/Non-stored/Producto no estocado - Sur stock Europe Zone 1 et Zone 2, nous consulter pour délai d'approvisionnement - Epuement/Stock depletion/Agotamiento del stock



Poignée de porte laitonné vieilli / LOUIS XV

PROTECT



GARANTIE

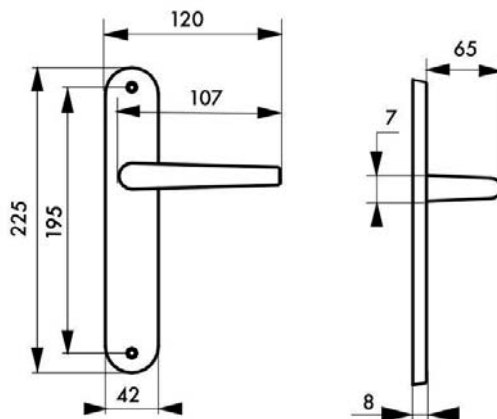

Description/Description/Descripción

Plaques alliage fondu. Béquilles alliage fondu. Carré acier 7
Vis métaux sécables. Entraxe de fixation 195 mm.

Cast alloy plates. Cast alloy handles. Steel spindle 7 mm.
Metal screws.

Placas de aleación fundida. Brazos de aleación fundida
acero de 7 mm. Tornillos para metal.

Finition/Finish/Acabado

Laitonné vieilli
Antique polished brass
Latón envejecido

Version/Option/Versión

Sans trou pour porte intérieure. Avec bouton de condamnation pour porte de salle de bains et W-C. Avec trou de clé pour porte intérieure. Avec trou de cylindre européen pour porte extérieure.

Without hole for inside door. With locking knob for bathroom doors and WC. With key hole for inside door. With european cylinder hole for entrance door.

Sin orificio para puerta interior. Con botón de condensación para puerta de cuartos de baño y WC. Con orificio de llave para puerta interior. Con orificio de cilindro europeo para puerta exterior.

Designation	Boite	Colis.	Prix	Sachet	Colis.	Prix	Brochable					Colis.	Prix
							France	Euro 1	Euro 2	Euro 3	Euro 4		
Louis XV sans trou BdC	-	-	-	00943320	6	-	-	-	-	-	-	-	-
Louis XV trou de clé, L	-	-	-	00943322	6	-	-	-	-	-	-	-	-
Louis XV trou de cylindre, I	-	-	-	00943323	6	-	-	-	-	-	-	-	-
Louis XV à condamnation	-	-	-	00943321	6	-	-	-	-	-	-	-	-

⚠ Non stocké/Non-stored/Producto no estocado - 📦 Sur stock Europe Zone 1 et Zone 2, nous consulter pour délai d'approvisionnement - 🇪🇺 Epuisement/Stock depletion/Agotamiento del stock

Poignée de porte aluminium / SULTANE

PROTECT



GARANTIE



00990403

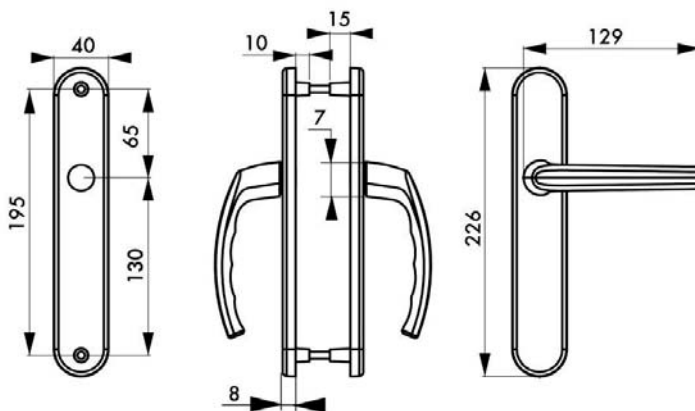

Description/Description/Descripción

Plaques zamak fondu. Béquilles aluminium fondu. Carré acier 7 mm. Vis métaux. Pour porte ép. 50 mm maxi. Entraxe de fixation 195mm.

Stamped zamak plates. Cast aluminium handles. Steel Square spindle 7 mm. Metal screws. For 50 mm maxi thickness door.

Placas de zamak embutido. Brazos de aluminio fundido. Cuadrado acero de 7 mm. Tornillos para metal de casquillo. Para puertas con un espesor máximo de 50 mm.

Finition/Finsih/Acabado

Blanc 9016, noir 9005, argent F1, aspect inox F9. White 9016, black 9005, silver, stainless steel appearance. Blanco 9016, negro 9005, plata, aspecto acero inoxidable.

Designation	Boite	Colis.	Prix	Sachet	Colis.	Prix	Brochable					Colis.	Prix
							France	Euro 1	Euro 2	Euro 3	Euro 4		
SULTANE sans trou BdC blanc	-	-	-	00990400	10	-	00590400	-	-	-	-	10	-
SULTANE trou de clé, L blanc	-	-	-	00990402	10	-	00590402	-	-	-	-	10	-
SULTANE trou de cylindre, I blanc	-	-	-	00990403	10	-	00590403	-	-	-	-	10	-
SULTANE à condamnation blanc	-	-	-	00990401	10	-	00590401	-	-	-	-	10	-
SULTANE palière blanc	-	-	-	00990404	10	-	00590404	-	-	-	-	10	-

Non stocké/Non-stored/Producto no estocado - Sur stock Europe Zone 1 et Zone 2, nous consulter pour délai d'approvisionnement - Epuement/Stock depletion/Agotamiento del stock



Poignée de porte aluminium / SULTANE

PROTECT



GARANTIE



00990410



00990422



00990414



00990424

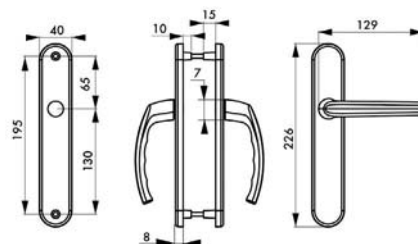

Description/Description/Descripción

Plaques zamak fondu. Béquilles aluminium fondu. Carré acier 7 mm. Vis métaux. Pour porte ép. 50 mm maxi. Entraxe de 195mm.

Stamped zamak plates. Cast aluminium handles. Steel Square spindle 7 mm. Metal screws. For 50 mm maxi thickness door.

Placas de zamak embutido. Brazos de aluminio fundido. Cuadrado acero de 7 mm. Tornillos para metal de casquillo. Para puertas con un espesor mde 50 mm.

Finition/Finsih/Acabado

Argent F1.

Silver.

Plata.

Designation	Boite	Colis.	Prix	Sachet	Colis.	Prix	Brochable					Colis.	Prix
							France	Euro 1	Euro 2	Euro 3	Euro 4		
SULTANE sans trou Bdc argent F1	-	-	-	00990410	10	-	00590410	-	-	-	-	10	-
SULTANE trou de clé, L argent F1	-	-	-	00990412	10	-	00590412	-	-	-	-	10	-
SULTANE trou de cylindre, l argent F1	-	-	-	00990413	10	-	00590413	-	-	-	-	10	-
SULTANE à condamnation argent F1	-	-	-	00990411	10	-	00590411	-	-	-	-	10	-
SULTANE palière argent F1	-	-	-	00990414	10	-	00590414	-	-	-	-	10	-
SULTANE sans trou inox F9	-	-	-	00990420	10	-	00590420	-	-	-	-	10	-
SULTANE trou de clé, L inox F9	-	-	-	00990422	10	-	00590422	-	-	-	-	10	-
SULTANE trou de cylindre, l inox F9	-	-	-	00990423	10	-	00590423	-	-	-	-	10	-
SULTANE à condamnation inox F9	-	-	-	00990421	10	-	00590421	-	-	-	-	10	-
SULTANE palière inox F9	-	-	-	00990424	10	-	00590424	-	-	-	-	10	-

⚠ Non stocké/Non-stored/Producto no estocado - ☑ Sur stock Europe Zone 1 et Zone 2, nous consulter pour délai d'approvisionnement - ☒ Epuisement/Stock depletion/Agotamiento del stock

Poignée de porte noire / SULTANE

PROTECT



GARANTIE

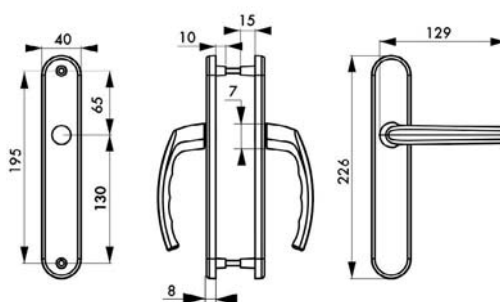

Description/Description/Descripción

Plaques aluminium fondu. Béquilles aluminium fondu. Carré acier 7 mm. Vis métaux. Pour porte ép. 50 mm maxi. Entraxe de 195mm.

Stamped aluminium plates. Cast aluminium handles. Steel Square spindle 7 mm. Metal screws. For 50 mm maxi thickness door.

Placas de aluminio embutido. Brazos de aluminio fundido. Cuadrado acero de 7 mm. Tornillos para metal de casquillo. Para puertas con un espesor mde 50 mm.

Finition/Finsih/Acabado

Noir 9005.

Black 9005.

Negro 9005.

Designation	Boite	Colis.	Prix	Sachet	Colis.	Prix	Brochable					Colis.	Prix
							France	Euro 1	Euro 2	Euro 3	Euro 4		
SULTANE sans trou BdC noir	-	-	-	00990430	10	-	00590430	-	-	-	-	10	-
SULTANE trou de clé, L noir	-	-	-	00990432	10	-	00590432	-	-	-	-	10	-
SULTANE trou de cylindre, l noir	-	-	-	00990433	10	-	00590433	-	-	-	-	10	-
SULTANE à condamnation noir	-	-	-	00990431	10	-	00590431	-	-	-	-	10	-
SULTANE palière noir	-	-	-	00990434	10	-	00590434	-	-	-	-	10	-

Non stocké/Non-stored/Productos no estocado - Sur stock Europe Zone 1 et Zone 2, nous consulter pour délai d'approvisionnement - Epuement/Stock depletion/Agotamiento del stock



Poignée de porte laiton / MARIANNE

RESIST



GARANTIE

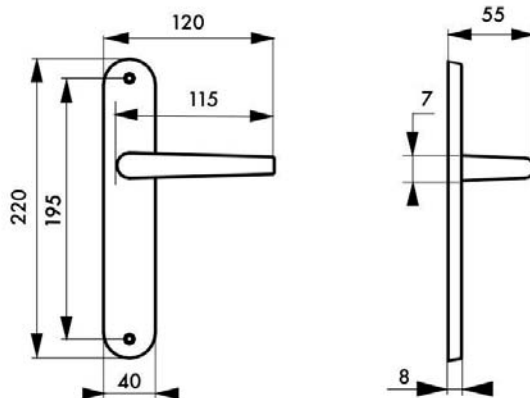

Description/Description/Descripción

Plaques laiton emboutii. Béquilles laiton massif, carré acier 7Vis métaux laiton à douille. Pour porte ép. 45 mm maxi. Entraxes de fixation 195 mm.

Solid brass plates. Solid brass handles. Steel square 7 mm. Brass screws. For 45 mm maxi thickness door.

Placas de latón macizo. Brazos de latón macizo, cuadrado acero de 7 mm. Tornillos para metal de latón de casquillo. Para puertas con un espesor máximo de 45 mm.

Finition/Finish/Acabado

Laiton poli

Polished brass

Latón pulido

Version/Option/Versión

Sans trou pour porte intérieure. Avec bouton de condamnation pour porte de salle de bains et W-C. Avec trou de clé pour porte intérieure. Avec trou de cylindre européen pour porte extérieure.

Without hole for inside door. With locking knob for bathroom doors and WC. With key hole for inside door. With european cylinder hole for entrance door.

Sin orificio para puerta interior. Con botón de condensación para puerta de cuartos de baño y WC. Con orificio de llave para puerta interior. Con orificio de cilindro europeo para puerta exterior.

Designation	Boite	Colis.	Prix	Sachet	Colis.	Prix	Brochable					Colis.	Prix
							France	Euro 1	Euro 2	Euro 3	Euro 4		
MARIANNE sans trou BdC	-	-	-	00900860	10	-	00500860	-	-	-	-	5	-
MARIANNE trou de clé, L	-	-	-	00900862	10	-	00500862	-	-	-	-	5	-
MARIANNE trou de cylindre, l	-	-	-	00900863	10	-	00500863	-	-	-	-	5	-
MARIANNE à condamnation	-	-	-	00900861	10	-	00500861	-	-	-	-	5	-

⚠ Non stocké/Non-stored/Producto no estocado - ☑ Sur stock Europe Zone 1 et Zone 2, nous consulter pour délai d'approvisionnement - ☒ Epuisement/Stock depletion/Agotamiento del stock

Poignée de porte Chromé poli/satin / MIRELLA 2

PROTECT

FROSIO
BORTOLO
1952
by THIRARD



GARANTIE

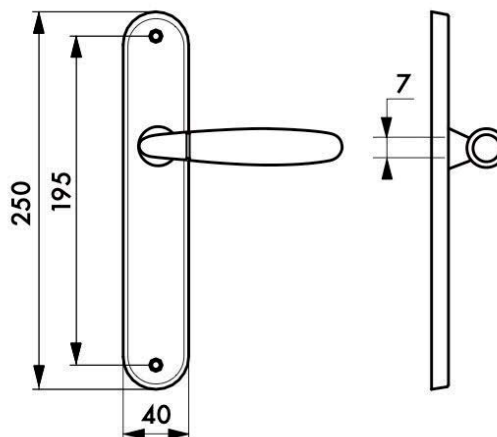

Description/Description/Descripción

Plaques laiton embouté. Béquilles laiton. Carré acier 7mm. Ressort de rappel. Vis métaux. Pour porte ép. 45mm maxi. Entraxe de fixation 195mm.

Brass plates. Brass handles. Steel square spindle 7mm. With spring. Metal screws. Mounting distance 195mm. Placas de latón. Brazos de latón. Cuadrado de acero de 7mm. Con muelle. Tornillos metálicos. Distancia de montaje 195mm.

Finition/Finish/Acabado

Chromé poli/satin.

Chrome plated/satin.

Cromado pulido/satinado.

Version/Option/Versión

Sans trou pour porte intérieure. Avec bouton de condamnation pour porte de salle de bains et W-C. Avec trou de clé pour porte intérieure. Avec trou de cylindre européen pour porte extérieure.

Without hole for inside door. With locking knob for bathroom doors and WC. With key hole for inside door. With european cylinder hole for entrance door.

Sin orificio para puerta interior. Con botón de condenación para puerta de cuartos de baño y WC. Con orificio de llave para puerta interior. Con orificio de cilindro europeo para puerta exterior.

Designation	Boite	Colis.	Prix	Sachet	Colis.	Prix	Brochable					Colis.	Prix
							France	Euro 1	Euro 2	Euro 3	Euro 4		
Ensemble poignée MIRELLA 2 E195 sans trou, chromé satin/brillant	00066758	1	-	-	-	-	-	-	-	-	-	-	-
Ensemble poignée MIRELLA 2 E195 trou de clé, L - chromé satin/brillant	00066753	1	-	-	-	-	-	-	-	-	-	-	-
Ensemble poignée MIRELLA 2 E195 trou de cylindre, l - chromé satin/brillant	00066754	1	-	-	-	-	-	-	-	-	-	-	-
Ensemble poignée MIRELLA 2 E 195 à condamnation, chromé satin/brillant	00066755	1	-	-	-	-	-	-	-	-	-	-	-

☒ Non stocké/Non-stored/Producto no estocado - ☑ Sur stock Europe Zone 1 et Zone 2, nous consulter pour délai d'approvisionnement - ☒ Epuement/Stock depletion/Agotamiento del stock



Poignée de porte inox / OURANUS RESIST



GARANTIE

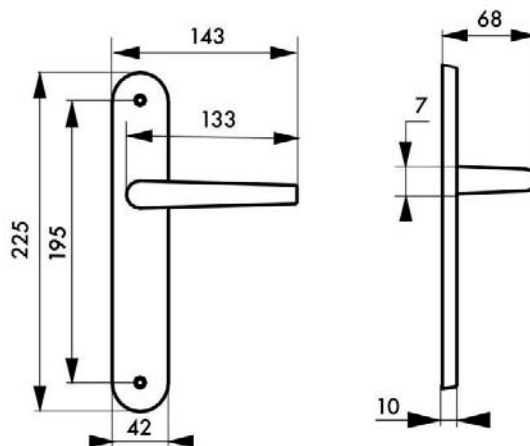

Description/Description/Descripción

Plaques inox 304 embouti. Béquilles inox 304. carré acier 7 mm. Ressort de rappel. Vis métaux sécables. Entr'axe de fixation 195 mm.

Inox 304 plates. Inox 304 handles. Steel spindle 7 mm. With spring. Metal screws.

Placas de acero inoxidable. Brazos de acero inoxidable acero de 7 mm. Com muelle. Tornillos para metal.

Finition/Finish/Acabado

Inox brossé

Polished stainless steel

Acero inoxidable cepillado

Version/Option/Versión

Sans trou pour porte intérieure. Avec bouton de condamnation pour porte de salle de bains et W-C. Avec trou de clé pour porte intérieure. Avec trou de cylindre européen pour porte extérieure.

Without hole for inside door. With locking knob for bathroom doors and WC. With key hole for inside door. With european cylinder hole for entrance door.

Sin orificio para puerta interior. Con botón de condensación para puerta de cuartos de baño y WC. Con orificio de llave para puerta interior. Con orificio de cilindro europeo para puerta exterior.

Designation	Boite	Colis.	Prix	Sachet	Colis.	Prix	Brochable					Colis.	Prix
							France	Euro 1	Euro 2	Euro 3	Euro 4		
Ouranus sans trou BdC	-	-	-	00990210	6	-	00590210	-	-	-	-	5	-
Ouranus trou de clé, L	-	-	-	00990212	6	-	00590212	-	-	-	-	5	-
Ouranus trou de cylindre, I	-	-	-	00990213	6	-	00590213	-	-	-	-	5	-
Ouranus à condamnation	-	-	-	00990211	6	-	00590211	-	-	-	-	5	-

⚠ Non stocké/Non-stored/Producto no estocado - 📦 Sur stock Europe Zone 1 et Zone 2, nous consulter pour délai d'approvisionnement - 📦 Epuisement/Stock depletion/Agotamiento del stock

Poignée de porte inox / POSEIDON RESIST



GARANTIE

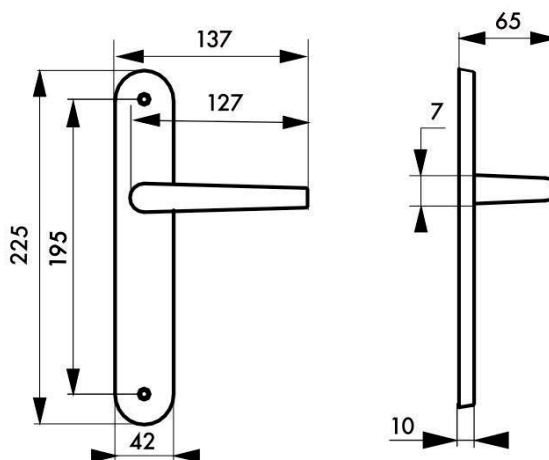

Description/Description/Descripción

Plaques inox 304 embouti. Béquilles inox 304. carré acier 7 mm. Ressort de rappel. Vis métaux sécables. Entr'axe de fixation 195 mm.

Inox 304 plates. Inox 304 handles. Steel spindle 7 mm. With spring. Metal screws.

Placas de acero inoxidable. Brazos de acero inoxidable acero de 7 mm. Com muelle. Tornillos para metal.

Finition/Finsih/Acabado

Inox brossé

Polished stainless steel

Acero inoxidable cepillado

Version/Option/Versión

Sans trou pour porte intérieure. Avec bouton de condamnation pour porte de salle de bains et W-C. Avec trou de clé pour porte intérieure. Avec trou de cylindre européen pour porte extérieure.

Without hole for inside door. With locking knob for bathroom doors and WC. With key hole for inside door. With european cylinder hole for entrance door.

Sin orificio para puerta interior. Con botón de condensación para puerta de cuartos de baño y WC. Con orificio de llave para puerta interior. Con orificio de cilindro europeo para puerta exterior.

Designation	Boîte	Colis.	Prix	Sachet	Colis.	Prix	Brochable					Colis.	Prix
							France	Euro 1	Euro 2	Euro 3	Euro 4		
Poseidon sans trou BdC	-	-	-	00990220	6	-	00590220	-	-	-	-	5	-
Poseidon trou de clé, L	-	-	-	00990222	6	-	00590222	-	-	-	-	5	-
Poseidon trou de cylindre, I	-	-	-	00990223	6	-	00590223	-	-	-	-	5	-
Poseidon à condamnation	-	-	-	00990221	6	-	00590221	-	-	-	-	5	-

Non stocké/Non-stored/Producto no estocado - Sur stock Europe Zone 1 et Zone 2, nous consulter pour délai d'approvisionnement - Epuement/Stock depletion/Agotamiento del stock





GARANTIE



Alliage de cuivre antimicrobien, élimine les virus et les bactéries. Testé en laboratoire Conforme à la norme NF S90-700.

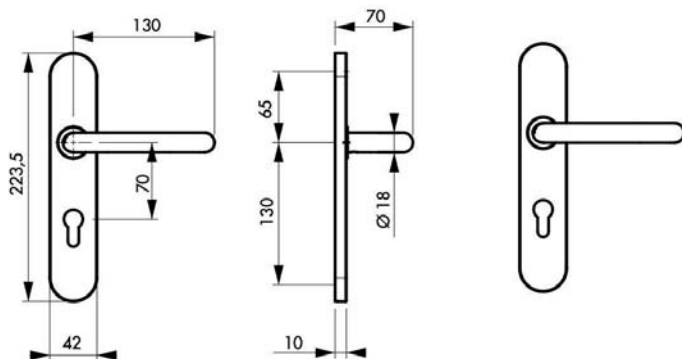

Description/Description/Descripción

Plaques inox. Béquilles cuivre. carré acier 7 mm. Ressort de rappel. Vis métaux sécables. Entraxe de fixation 195 mm.

Stainless steel plates. Copper handles. Steel spindle 7 mm. With spring. Metal screws.

Placas de acero inoxidable. Brazos de cobre. acero de 7 mm. Com muelle. Tornillos para metal.

Finition/Finish/Acabado

Inox brossé-cuivre

Stainless steel brushed-Copper

Acero inoxidable cepillado-Cobre

Version/Option/Versión

Avec bouton de condamnation pour porte de salle de bains et W-C. Avec trou de cylindre européen.

With locking knob for bathroom doors and WC. With european cylinder hole.

Con botón de condenación para puerta de cuartos de baño y WC. Con orificio de cilindro europeo.

Designation	Boite	Colis.	Prix	Sachet	Colis.	Prix	Brochable					Colis.	Prix
							France	Euro 1	Euro 2	Euro 3	Euro 4		
Poignée sur plaque cuivre trou de cylindre, I	00019111	1	-	-	-	-	-	-	-	-	-	-	-
Poignée sur plaque cuivre à condamnation	00019311	1	-	-	-	-	-	-	-	-	-	-	-
Produit nettoyant / régénérant 750 ml + 2 tampons cleaner	00019110	1	-	-	-	-	-	-	-	-	-	-	-

Poignée de porte porcelaine / BEQUILLE - BOUTON

PROTECT



GARANTIE

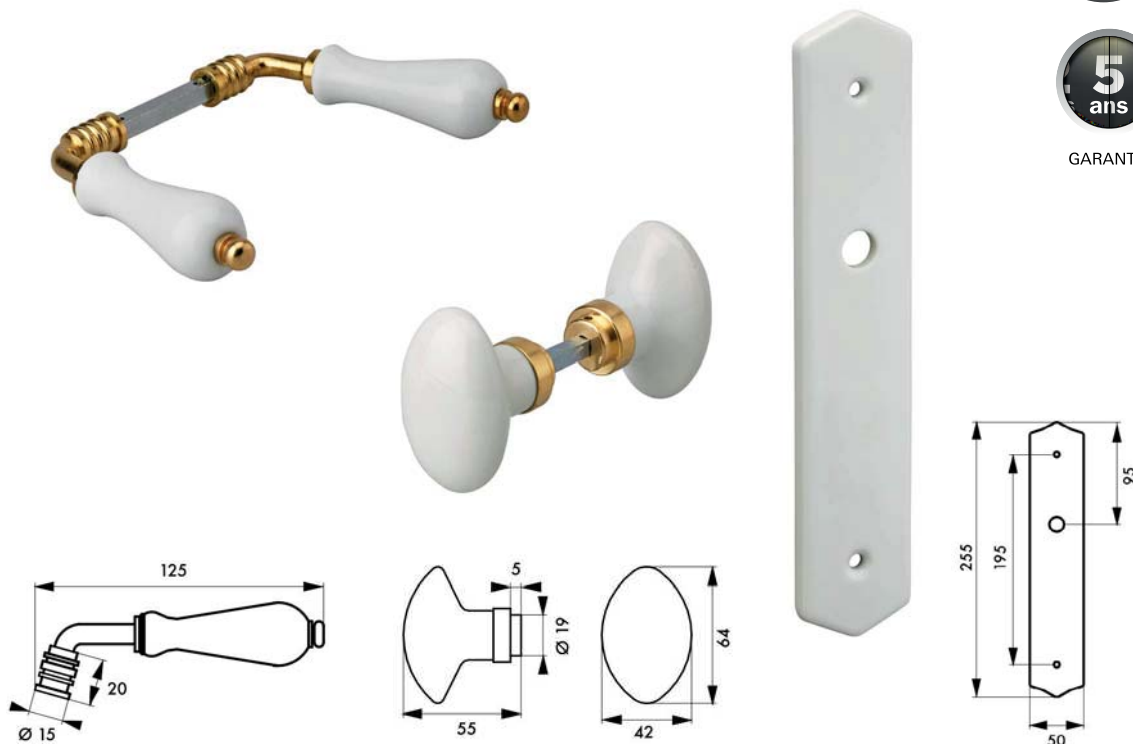

Description/Description/Descripción

Béquille poire et boutons ovales porcelaine. Monture laiton. Carré acier 7 mm. Pour porte + serrure ép. 70~mm maxi.

Porcelain oval handles and knob. Brass frame. Steel Square 7 mm. For 70~mm maxi thickness door and lock. Brazo pera y botones ovalados de porcelana. Montura de latón. Cuadrado acero. Para puertas y cerraduras con un espesor máximo de 70~mm.

Finition/Finsih/Acabado

Blanc

White

Blanco

Version/Option/Versión

Béquille double avec carré 72 portées PVC. Bouton double avec carré 62 portées laiton.

Double handle with square 72 PVC double bossing. Double knob with square 62~mm brass double bossing.

Brazo doble con cuadrado de 72 asientos de PVC. Botón doble con cuadrado de 62 asientos de latón.

Designation	Boite	Colis.	Prix	Sachet	Colis.	Prix	Brochable					Colis.	Prix
							France	Euro 1	Euro 2	Euro 3	Euro 4		
BEQUILLE DOUBLE carré 72 portées	00000471	10	-	-	-	-	00200471	-	-	-	-	10	-
BOUTON DOUBLE carré 6 avec fourreau adaptateur 7 mm 2 portées	00000481	10	-	00900481	20	-	00200481	-	-	-	-	10	-
PLAQUE DE PROPRETE sans trou BdC	-	-	-	-	-	-	00400572	-	-	-	-	10	-
PLAQUE DE PROPRETE trou de clé	-	-	-	-	-	-	00400573	-	-	-	-	10	-
PLAQUE DE PROPRETE trou de cylindre. profilé	-	-	-	-	-	-	00400571	-	-	-	-	10	-
PLAQUE DE PROPRETE bouton de condamnation	-	-	-	-	-	-	00400574	-	-	-	-	10	-
PLAQUE DE PROPRETE trou de décondamnation	-	-	-	-	-	-	00401574	-	-	-	-	10	-

Non stocké/Non-stored/Producto no estocado - Sur stock Europe Zone 1 et Zone 2, nous consulter pour délai d'approvisionnement - Epuisement/Stock depletion/Agotamiento del stock



Poignée de porte couleur F2, blanc / PICARDIE

PROTECT



GARANTIE

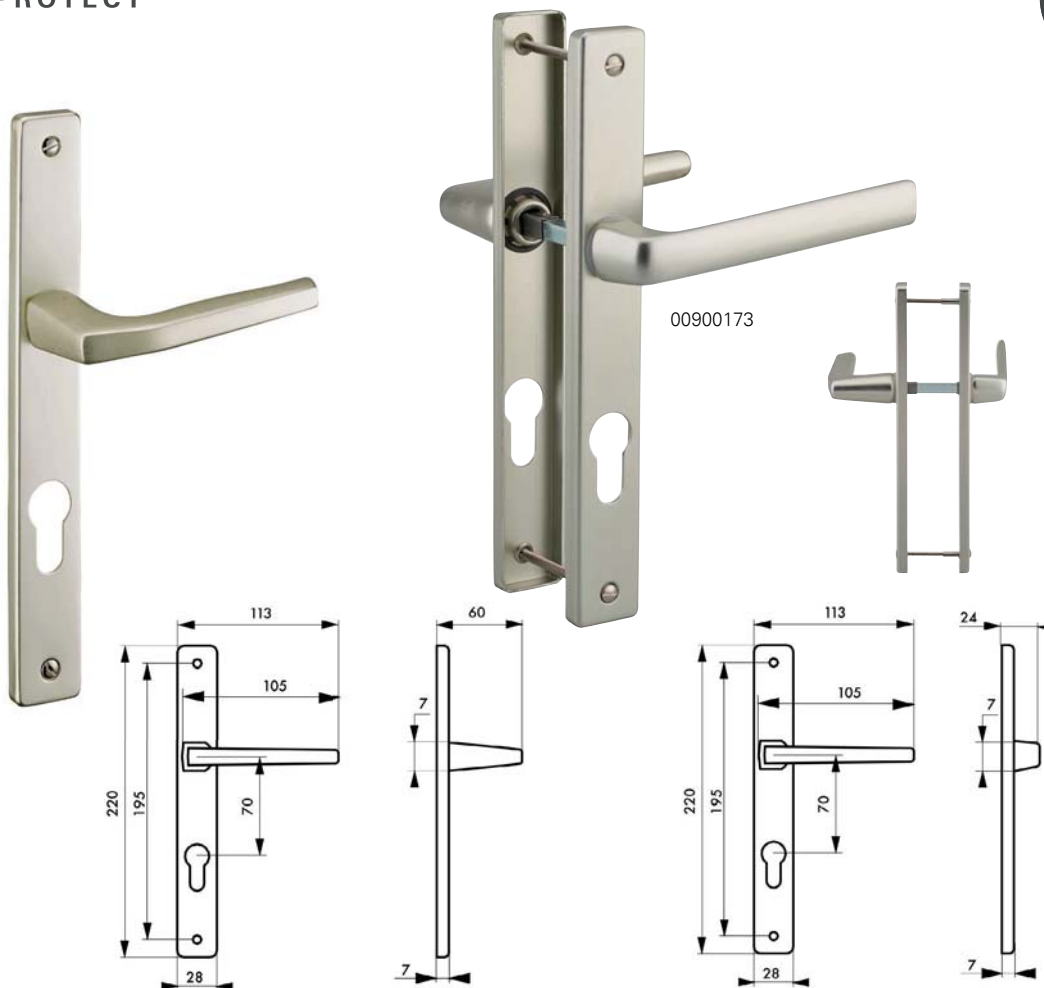

Description/Description/Descripción

Plaques étroites aluminium embouti. Béquilles aluminium fondu, carré acier 7 mm. Vis métaux à douille. Pour porte ép. 45 mm maxi. Entr'axe de fixation 195 mm.

Stamped aluminium narrow plates. Cast aluminium handles. Steel square spindle 7 mm. Metal screws. For 45 mm maxi thickness door.

Placas estrechas de aluminio embutido. Brazos de aluminio fundido, cuadrado acero de 7 mm. Tornillos para metal de casquillo. Para puertas con un espesor máximo de 45 mm.

Finition/Finsih/Acabado

Anodisé couleur F2 ou laqué blanc
Color F2 anodized or white lacquered
Anodizado color F2 o lacado blanco

Version/Option/Versión

Avec béquille à saillie réduite côté extérieur pour fenêtre avec volets.

With reduced outside handle for windows with shutters. Con brazo de saliente reducido por el lado exterior para ventana con contraventanas.

Designation	Boite	Colis.	Prix	Sachet	Colis.	Prix	Brochable					Colis.	Prix
							France	Euro 1	Euro 2	Euro 3	Euro 4		
PICARDIE couleur F2 trou de cylindre, I	-	-	-	00900373	5	-	00500373	-	-	-	-	10	-
PICARDIE laqué blanc trou de cylindre, I	-	-	-	00900273	5	-	00500273	-	-	-	-	10	-
PICARDIE couleur F2 trou de cylindre, I saillie réduite	-	-	-	00900173	5	-	00500173	-	-	-	-	10	-
PICARDIE laqué blanc trou de cylindre, I saillie réduite	-	-	-	00900073	5	-	00500073	-	-	-	-	10	-

⚠ Non stocké/Non-stored/Producto no estocado - ☑ Sur stock Europe Zone 1 et Zone 2, nous consulter pour délai d'approvisionnement - ☑ Epusement/Stock depletion/Agotamiento del stock

Poignée de porte blanc / SAFIR

PROTECT



GARANTIE

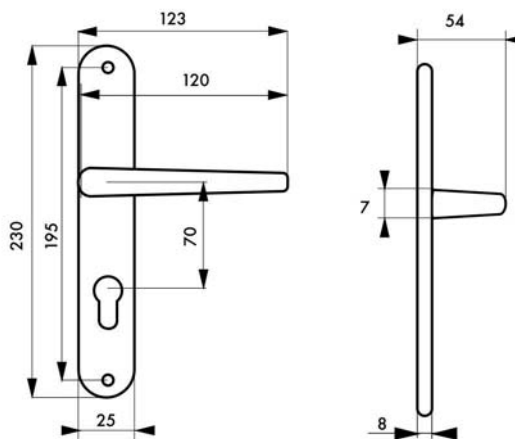

Description/Description/Descripción

Plaques étroites alliage. Béquilles alliage. Carré acier 7Vis métaux à douille. Entraxe de 70 mm.

Stamped alloy narrow plates. Cast alloy handles. Steel square spindle 7 mm. Metal screws.

Placas estrechas de aleación. Brazos de aleación. Cuadrado acero de 7 mm. Tornillos para metal de casquillo.

Finition/Finsih/Acabado

Laqué blanc

White lacquered

Lacado blanco

Version/Option/Versión

Entr'axe 92 mm. Avec béquille à saillie réduite côté extérieur pour fenêtre avec volets.

With reduced outside handle for windows with shutters.

Con brazo de saliente reducido por el lado exterior para ventana con contraventanas.

Designation	Boite	Colis.	Prix	Sachet	Colis.	Prix	Brochable					Colis.	Prix
							France	Euro 1	Euro 2	Euro 3	Euro 4		
SAFIR trou de cylindre, l entr'axe axes 70mm	00043430	10	-	-	-	-	00543430	-	-	-	-	5	-
SAFIR trou de cylindre, l entr'axe axes 92mm	00043431	10	-	-	-	-	00543431	-	-	-	-	5	-
SAFIR trou de cylindre, l entr'axe axes 70mm saillie réduite	00043432	10	-	-	-	-	00543432	-	-	-	-	5	-
SAFIR trou de cylindre entr'axe axes 92mm saillie réduite	00043433	10	-	-	-	-	00543433	-	-	-	-	5	-

Non stocké/Non-stored/Producto no estocado - Sur stock Europe Zone 1 et Zone 2, nous consulter pour délai d'approvisionnement - Epuisement/Stock depletion/Agotamiento del stock



Poignée de porte aluminium / SULTANE PROTECT



GARANTIE

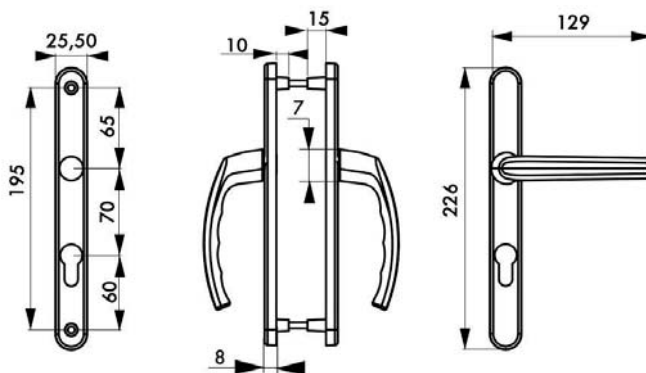
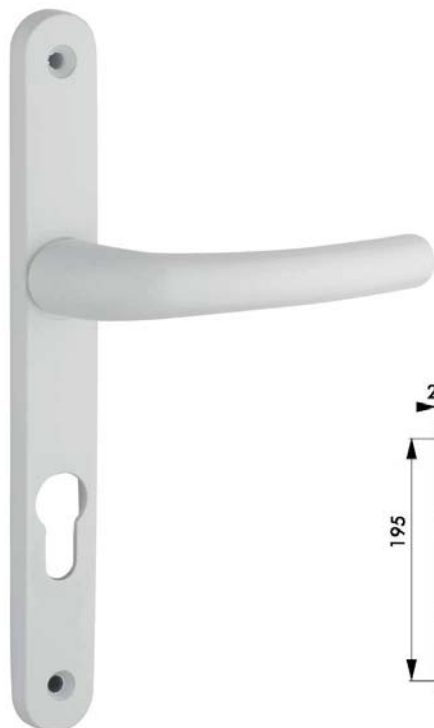

Description/Description/Descripción

Plaques alliage fondu. Béquilles aluminium fondu. Carré acier 7 mm. Vis métaux. Pour porte ép. 60 mm maxi. Entraxe de 195mm.

Stamped alloy plates. Cast aluminium handles. Steel Square spindle 7 mm. Metal screws. For 60 mm maxi thickness door.

Placas de aleación embutido. Brazos de aluminio fundido. Cuadrado acero de 7 mm. Tornillos para metal de casquillo. Para puertas con un espesor mde 60 mm.

Finition/Finsih/Acabado

Blanc 9016, noir 9005, argent F1, aspect inox F9.

White 9016, black 9005, silver, Stainless steel appearance.

Blanco 9016, negro 9005, silver, aspecto acero inoxidable.

Version/Option/Versión

Entraxe de xation 165mm. Sans trou pour porte intérieure. Avec bouton de condamnation pour porte de salle de bains et W-C. Avec trou de clé pour porte intérieure. Avec trou de cylindre européen pour porte extérieure.

Avec trou de cylindre européen pour porte palière.

Without hole for inside door. With locking knob for bathroom doors and WC. With key hole for inside door. With European cylinder hole for entrance door. With European cylinder hole for outdoor.

Sin oricio para puerta interior. Con botde condenación para puerta de cuartos de baño y WC. Con oricio de llave para puerta interior. Con oricio de cilindro europeo para puerta exterior.

Designation	Boite	Colis.	Prix	Sachet	Colis.	Prix	Brochable					Colis.	Prix
							France	Euro 1	Euro 2	Euro 3	Euro 4		
SULTANE 235x25 C7x70mm trou de cylindre blanc	-	-	-	00990405	10	-	00590405	-	-	-	-	10	-
SULTANE 235x25 C7x70mm trou de cylindre béquille saillie réduite blanc	-	-	-	00990408	10	-	00590408	-	-	-	-	10	-
SULTANE 235x25 C7x70 trou de cylindre palière blanc	-	-	-	00990450	10	-	00590450	-	-	-	-	10	-
SULTANE 235x25 C7x70mm trou de cylindre argent F1	-	-	-	00990415	10	-	00590415	-	-	-	-	10	-
SULTANE 235x25 C7x70 trou de cylindre palière argent F1	-	-	-	00990451	10	-	00590451	-	-	-	-	10	-
SULTANE 235x25 C7x70mm trou de cylindre inox F9	-	-	-	00990425	10	-	00590425	-	-	-	-	10	-
SULTANE 235x25 C7x70mm trou de cylindre béquille saillie réduite inox F9	-	-	-	00990428	10	-	00590428	-	-	-	-	10	-

⚠ Non stocké/Non-stored/Producto no estocado - 📦 Sur stock Europe Zone 1 et Zone 2, nous consulter pour délai d'approvisionnement - 📦 Epuisement/Stock depletion/Agotamiento del stock

Poignée de porte aspect inox, blanc, argent, noir / SULTANE entraxe 92

PROTECT



GARANTIE

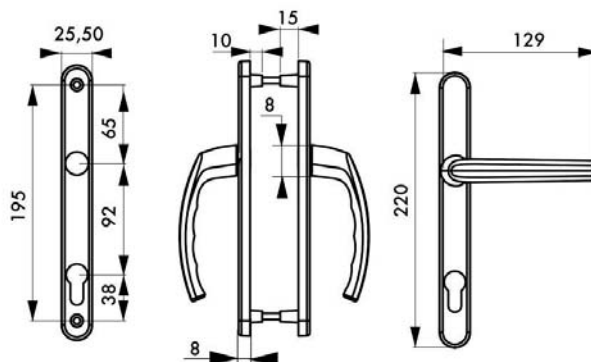

Description/Description/Descripción

Plaques alliage fondu. Béquilles aluminium fondu. Carré acier 8 mm. Vis métaux. Pour porte ép. 60 mm maxi. Entraxe de 195mm.

Stamped alloy plates. Cast aluminium handles. Steel Square spindle 8 mm. Metal screws. For 60 mm maxi thickness door.

Placas de aleación embutido. Brazos de aluminio fundido. Cuadrado acero de 8 mm. Tornillos para metal de casquillo. Para puertas con un espesor mde 60 mm.

Finition/Finsih/Acabado

Blanc 9016, noir 9005, argent F1, aspect inox F9.

White 9016, black 9005, silver, Stainless steel appearance. Blanco 9016, negro 9005, silver, aspecto acero inoxidable.

Version/Option/Versión

Entraxe de 165mm. Sans trou pour porte intv0érieure. Avec bouton de condamnation pour porte de salle de bains et W-C. Avec trou de clé pour porte intérieure. Avec trou de cylindre européen pour porte extérieure. Avec trou de cylindre européen pour porte palière.

Without hole for inside door. With locking knob for bathroom doors and WC. With key hole for inside door. With european cylinder hole for entrance door. With European cylinder hole for outdoor.

Sin oricio para puerta interior. Con botde condenación para puerta de cuartos de baño y WC. Con oricio de llave para puerta interior. Con oricio de cilindro europeo para puerta exterior.

Designation	Boite	Colis.	Prix	Sachet	Colis.	Prix	Brochable					Colis.	Prix
							France	Euro 1	Euro 2	Euro 3	Euro 4		
SULTANE 235x25 C8x92mm trou de cylindre blanc	-	-	-	00990406	10	-	00590406	-	-	-	-	10	-
SULTANE 235x25 C8x92mm trou de cylindre béquille saillie réduite blanc	-	-	-	00990409	10	-	00590409	-	-	-	-	10	-
SULTANE 235x25 C8x92 trou de cylindre palière blanc	-	-	-	00990452	10	-	00590452	-	-	-	-	10	-
SULTANE 235x25 C8x92 trou de cylindre palière argent F1	-	-	-	00990453	10	-	00590453	-	-	-	-	10	-
SULTANE 235x25 C8x92mm trou de cylindre inox F9	-	-	-	00990426	10	-	00590426	-	-	-	-	10	-
SULTANE 235x25 C8x92mm trou de cylindre béquille saillie réduite inox F9	-	-	-	00990429	10	-	00590429	-	-	-	-	10	-
SULTANE 235x25 C8x92mm trou de cylindre noir	-	-	-	00990437	10	-	00590437	-	-	-	-	10	-

Non stocké/Non-stored/Producto no estocado - Sur stock Europe Zone 1 et Zone 2, nous consulter pour délai d'approvisionnement - Epuisement/Stock depletion/Agotamiento del stock



Poignée de porte noire / BOUTON ECO



GARANTIE

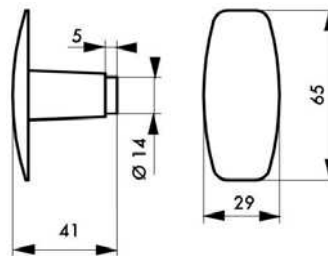

Description/Description/Descripción

Bouton double en alliage. 1 portée. Carré acier 6 Réglage par vis pointeau. Pour porte + serrure ép. 70~mm maxi
Alloy knob. Single bossing. Steel square spindle 6 mm. Adjustment by screw. For 70 mm maxi thickness door and lock.

Botón de aleación. 1 asiento. cuadrado acero de 6 mm. Ajuste mediante aguja de punta cónica. Para puerta + cerradura con un espesor máximo de 70 mm.

Finition/Finsih/Acabado

Noir 9005.

Black 9005.

Negro 9005.

Utilisation/Use/Utilización

Pour tous types de serrures à appliquer horizontale.

For all kinds of horizontal rim lock.

Para todo tipo de cerraduras de plastrón.

Designation	Boite	Colis.	Prix	Sachet	Colis.	Prix	Brochable					Colis.	Prix
							France	Euro 1	Euro 2	Euro 3	Euro 4		
BOUTON DOUBLE carré 6x110mm 1 portée noir	00000488	10	-	00900488	10	-	-	-	-	-	-	-	-

Poignée de porte noire / BOUTON ECO



GARANTIE

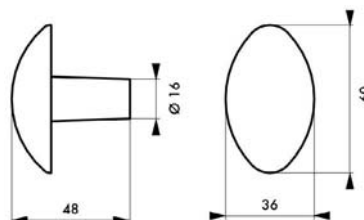

Description/Description/Descripción

Boutons fonte. carré acier 6 Sans portée. Pour porte + serrure ép. 60~mm maxi.
Cast iron knobs. Steel square 6 mm. For door and lock 60 mm maxi thickness.

Botones de fundición. acero de 6 mm. Sin asiento. Para puertas y cerraduras con un espesor máximo de 60 mm

Finition/Finsih/Acabado

Noir

Black

Negro

Designation	Boite	Colis.	Prix	Sachet	Colis.	Prix	Brochable					Colis.	Prix
							France	Euro 1	Euro 2	Euro 3	Euro 4		
BOUTON DOUBLE FONTE PEINTE carré 6 mm	00008728	10	-	00908728	10	-	00208728	-	-	-	-	10	-
BOUTON DOUBLE FONTE PEINTE carré 6 mm avec fourreau adaptateur 7 mm	-	-	-	-	-	-	00218728	-	-	-	-	10	-

Poignée de porte noire / BOUTON RESIST



GARANTIE

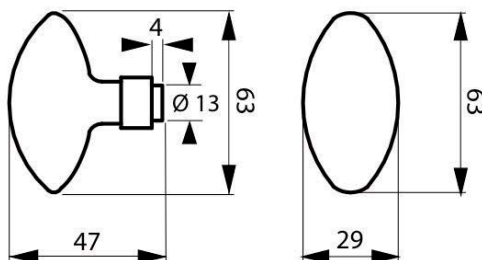

Description/Description/Descripción

Bouton double en alliage. 1 portée. Carré acier. Réglage par vis pointeau. Pour porte + serrure ép. 43 mm maxi.
Alloy knob. Single bossing. Steel square spindle. Adjustment by screw. For 43 mm maxi thickness door and lock.
 Botón de aleación. 1 asiento. cuadrado acero. Ajuste mediante aguja de punta cónica. Para puerta + cerradura con un espesor máximo de 43 mm.

Finition/Finish/Acabado

Noir 9005.
Black 9005.
 Negro 9005.

Version/Option/Versión

Carré 6 mm. Carré 7 mm.
Square 6 mm. Square 7 mm.
 Cuadrado 6 mm. Cuadrado 7 mm.

Utilisation/Use/Utilización

Pour tous types de serrures à appliquer horizontale.
For all kinds of horizontal rim lock.
 Para todo tipo de cerraduras de plastrón.

Designation	Boite	Colis.	Prix	Sachet	Colis.	Prix	Brochable					Colis.	Prix
							France	Euro 1	Euro 2	Euro 3	Euro 4		
BOUTON DOUBLE ovoïde carré 6x90mm 1 portée noir	00006802	10	-	00906802	10	-	-	-	-	-	-	-	-
BOUTON DOUBLE ovoïde carré 7x90mm 1 portée noir	00006803	10	-	00906803	10	-	-	-	-	-	-	-	-

⊠ Non stocké/Non-stored/Producto no estocado - ⊠ Sur stock Europe Zone 1 et Zone 2, nous consulter pour délai d'approvisionnement - ⊠ Epuisement/Stock depletion/Agotamiento del stock



Poignée de porte / BOUTON DOUBLE LAITON RESIST



GARANTIE

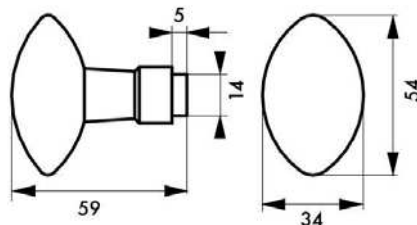

Description/Description/Descripción

Bouton laiton massif. 1 portée. Carré acier 6 mm. Réglage par vis pointeau. Pour porte + serrure ép. 80 mm maxi.

Solid brass knob. Single bossing. Steel Square spindle 6 mm. Adjustment by screw. For 80 mm maxi thickness door and lock.

Botón de latón macizo. 1 asiento - Cuadrado acero de

6 mm. Ajuste mediante tornillos para metal. Para puerta y cerradura con un espesor máximo de 80 mm.

Finition/Finsih/Acabado

Laiton poli
Polished brass
Latón pulido

Designation	Boite	Colis.	Prix	Sachet	Colis.	Prix	Brochable					Colis.	Prix
							France	Euro 1	Euro 2	Euro 3	Euro 4		
BOUTON DOUBLE carré 6 mm 1 portée ovale	-	-	-	00900484	20	-	00200484	-	-	-	-	5	-

Pommeau porte laiton RESIST



GARANTIE

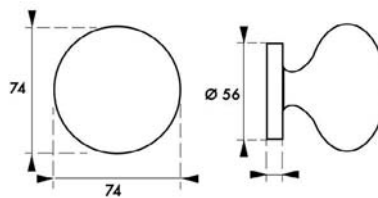

Description/Description/Descripción

Bouton fixe laiton. Rosace laiton. Traitement au titane (PVD) contre l'oxydation.

Fixed brass knob. Brass rosette. Titanium treatment (PVD) to prevent oxidation.

Pomo fi jo de latón. Rosa de latón. Tratamiento de titanio (PVD) contra la oxidación.

Finition/Finsih/Acabado

Laiton poli
Polished brass
Latón pulido

Utilisation/Use/Utilización

Bouton décoratif pour porte d'entrée, porte palière.

Decorative knob for entrance door, landing door.

Pomo decorativo para puerta de entrada, puerta de rellano.

Designation	Boite	Colis.	Prix	Sachet	Colis.	Prix	Brochable					Colis.	Prix
							France	Euro 1	Euro 2	Euro 3	Euro 4		
Pommeau porte ø 74mm, base ø 56mm	-	-	-	00966795	1	-	-	-	-	-	-	-	-

⚠ Non stocké/Non-stored/Producto no estocado - 📦 Sur stock Europe Zone 1 et Zone 2, nous consulter pour délai d'approvisionnement - 📦 Epuisement/Stock depletion/Agotamiento del stock

Poignée de porte argent ou noire / BEQUILLE DOUBLE PROTECT

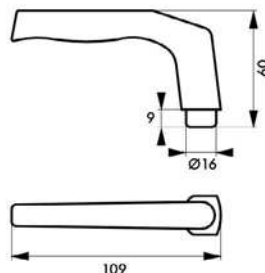

GARANTIE

Description/Description/Descripción

Béquilles aluminium fondu. Carré acier 8mm. 1 portée. Réglage par vis pointeau. Pour porte + serrure ép. 70\~mm maxi.

Cast aluminium handles. Steel Square 8mm. Single bossing. Adjustment by screw. For 70\~mm maxi thickness door and lock.

Brazos de aluminio fundido. Cuadrado acero de 8mm. 1

asiento. Ajuste mediante aguja de punta cónica. Para puertas y cerraduras con un espesor máximo de 70\~mm.

Finition/Finsih/Acabado

Anodisé argent ou noir 9005

Silver anodized or black 9005

Anodizado plata o negro 9005

Designation	Boite	Colis.	Prix	Sachet	Colis.	Prix	Brochable					Colis.	Prix
							France	Euro 1	Euro 2	Euro 3	Euro 4		
BEQUILLE DOUBLE argent carré 8	00072929	10	-	-	-	-	00272929	-	-	-	-	10	-
BEQUILLE DOUBLE noire carré 8	00072930	10	-	-	-	-	00272930	-	-	-	-	10	-

Poignée de porte argent ou noire / BEQUILLE DOUBLE PROTECT



GARANTIE

Description/Description/Descripción

Béquilles aluminium fondu. Carré acier 110 mm. 1 portée. Réglage par vis pointeau. Pour porte + serrure ép. 70\~mm maxi.

Cast aluminium handles. Steel Square 110 mm. Single bossing. Adjustment by screw. For 70\~mm maxi thickness door and lock.

Brazos de aluminio fundido. Cuadrado acero de 110 mm. 1 asiento. Ajuste mediante aguja de punta cónica. Para puertas y cerraduras con un espesor máximo de

70\~mm.

Finition/Finsih/Acabado

Anodisé argent ou noir 9005.

Silver anodized or black 90050.

Anodizado plata o negro 9005.

Version/Option/Versión

Carré 6 mm, 7 mm, 8\~mm.

Square 6mm, 7mm, 8\~mm.

Cuadrado 6mm, 7mm, 8\~mm.

Designation	Boite	Colis.	Prix	Sachet	Colis.	Prix	Brochable					Colis.	Prix
							France	Euro 1	Euro 2	Euro 3	Euro 4		
BEQUILLE DOUBLE carré 6x110mm noire	00003473	10	-	00903473	10	-	-	-	-	-	-	-	-
BEQUILLE DOUBLE carré 7x110mm noire	00003474	10	-	00903474	10	-	-	-	-	-	-	-	-
BEQUILLE DOUBLE carré 7x110mm argent	00003475	10	-	00903475	10	-	-	-	-	-	-	-	-
BEQUILLE DOUBLE carré 8x110mm noir	00003476	10	-	00903476	10	-	-	-	-	-	-	-	-

Non stocké/Non-stored/Producto no estocado - Sur stock Europe Zone 1 et Zone 2, nous consulter pour délai d'approvisionnement - Epuement/Stock depletion/Agotamiento del stock



Poignée de porte argent ou couleur F2 / BEQUILLE DOUBLE PROTECT



GARANTIE

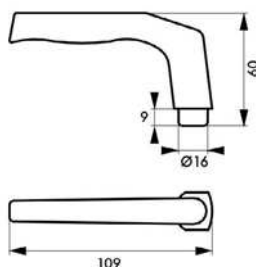

Description/Description/Descripción

Béquilles aluminium fondu. Carré acier 71 portée. Réglage par vis pointeau. Pour porte + serrure ép. 70\~mm maxi.

Cast aluminium handles. Steel Square 7 mm. Single bossing. Adjustment by screw. For 70 mm maxi thickness door and lock.

Brazos de aluminio fundido. Cuadrado acero de 7 mm. 1 asiento. Ajuste mediante aguja de punta cónica. Para puertas y cerraduras con un espesor máximo de 70 mm.

Finition/Finsih/Acabado

Anodisé argent ou couleur F2.

Silver or color F2 anodized.

Anodizado plata o color F2.

Version/Option/Versión

Avec carré acier 8 Avec carré acier 8 et plaque extérieure trou de clé. Avec carré acier 8\~mm et plaque extérieure trou de cylindre.

With steel square 8 With steel square 8 and keyhole outside plate. With steel square 8\~mm and cylinder hole outside plate.

Con cuadrado acero de 8 Con cuadrado acero de 8 y placa exterior con orificio de llave. Con cuadrado acero de 8\~mm y placa exterior con orificio de cilindro.

Designation	Boite	Colis.	Prix	Sachet	Colis.	Prix	Brochable					Colis.	Prix
							France	Euro 1	Euro 2	Euro 3	Euro 4		
BEQUILLE DOUBLE argent carré 7 mm	-	-	-	00903470	20	-	00203470	-	-	-	-	10	-
BEQUILLE DOUBLE argent carré 8 mm	00005470	10	-	00905470	20	-	00205470	-	-	-	-	10	-
BEQUILLE DOUBLE couleur F2 carré 7 mm	-	-	-	00904470	20	-	00204470	-	-	-	-	10	-
1/2 BEQUILLE DOUBLE couleur F2 carré 7 mm	-	-	-	-	-	-	00204471	-	-	-	-	10	-
BEQUILLE DOUBLE couleur F2 carré 8 mm	-	-	-	-	-	-	00206470	-	-	-	-	10	-
BEQUILLE DOUBLE couleur F2 + 1 plaque carré 8 x 56 mm trou de clé	-	-	-	00907470	10	-	00507470	-	-	-	-	10	-
BEQUILLE DOUBLE couleur F2 + 1 plaque carré 8 x 56 mm trou de cylindre	-	-	-	00908470	10	-	00508470	-	-	-	-	10	-

⚠ Non stocké/Non-stored/Producto no estocado - 📦 Sur stock Europe Zone 1 et Zone 2, nous consulter pour délai d'approvisionnement - 📦 Epuisement/Stock depletion/Agotamiento del stock

Poignée de porte argent ou blanc / BEQUILLE DOUBLE / BE- QUILLE DOUBLE - ROSACE

PROTECT

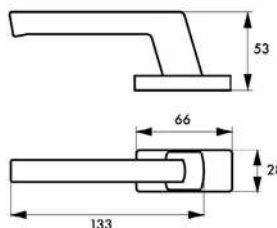

GARANTIE

Description/Description/Descripción

Béquilles aluminium fondu. Carré acier 7 mm avec fourreau 7 à 8 mm fourni. Fixation invisible par vis métaux. Pour porte ép. 70 mm maxi. Rosace avec trou de cylindre européen aluminium embouti.

Casts aluminium handles. Steel Square 7 mm. Invisible fixing by metal screws. For 70 mm maxi thickness door. European cylinder hole stamped aluminium keyhole rose. Brazos de aluminio fundido. Cuadrado acero de 7 mm. Fijación invisible mediante tornillos para metal. Para puertas con un espesor máximo de 70 mm. Embellecedor con orificio de cilindro europeo de aluminio embutido.

Finition/Finsih/Acabado

Anodisé argent ou laqué blanc
Silver anodized or white
Anodizado color plata o lacado blanco

Utilisation/Use/Utilización

Pour porte à menuiserie métallique ou P.V.C.
Narrow steel or P.V.C doors
Para puerta con marco metálico o de PVC

Designation	Boite	Colis.	Prix	Sachet	Colis.	Prix	Brochable					Colis.	Prix
							France	Euro 1	Euro 2	Euro 3	Euro 4		
BEQUILLE DOUBLE argent carré 7 mm	-	-	-	-	-	-	00200499	-	-	-	-	10	-
BEQUILLE DOUBLE laqué blanc carré 7 mm	-	-	-	-	-	-	00200498	-	-	-	-	10	-

Accessoires / ROSACES

PROTECT

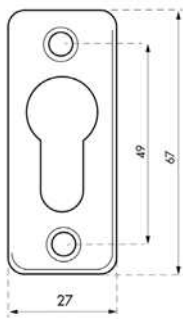

GARANTIE

Description/Description/Descripción

Rosace aluminium embouti. Fixation par vis métaux.
Stamped aluminium plates. Fixing by metal screws.
Placas de aliminio embutido. Fijación tornillos para metal.

Finition/Finsih/Acabado

Blanc 9016, noir 9005, argent F1.
White 9016, black 9005, silver.
Blanco 9016, negro 9005, plata.

Designation	Boite	Colis.	Prix	Sachet	Colis.	Prix	Brochable					Colis.	Prix
							France	Euro 1	Euro 2	Euro 3	Euro 4		
Paire de rosaces rectangulaires CP - argent F1	00090333	10	-	-	-	-	-	-	-	-	-	-	-
Paire de rosaces rectangulaires CP - blanc 9016	00090334	10	-	-	-	-	-	-	-	-	-	-	-
Paire de rosaces rectangulaires CP - noir 9005	00090335	10	-	-	-	-	-	-	-	-	-	-	-

Non stocké/Non-stored/Producto no estocado - Sur stock Europe Zone 1 et Zone 2, nous consulter pour délai d'approvisionnement - Epuement/Stock depletion/Agotamiento del stock



Poignée de porte / BEQUILLE DOUBLE SUR ROSACE PROTECT



GARANTIE



Description/Description/Descripción

Béquilles alliage. Carré acier 8 Ressort de rappel. Fixation invisible par vis métaux. Pour porte épaisseur 40 à 70mm maxi. Entraxe de fixation variable de 43 ou 50 mm.

Cast alloy handles. Steel Square spindle 8 mm. Invisible fixing by metal screws. For 40 to 70 mm maxi thickness door. With spring. Metal screws.

Brazos de aleación fundida Cuadrado acero de 8 mm. Fijación invisible mediante tornillos para metal. Para puertas con un espesor máximo de 40 - 70 mm maxi. Com muelle.

Finition/Finsih/Acabado

Laqué blanc, argent F1, noir 9005

White lacquered, silver, black 9005

Lacado blanco, plata, negro 9005

Utilisation/Use/Utilización

Pour porte à menuiserie métallique, alu ou P.V.C.

Narrow steel, alu or P.V.C doors

Para puerta con marco metálico, alu o de PVC

Designation	Boite	Colis.	Prix	Sachet	Colis.	Prix	Brochable					Colis.	Prix
							France	Euro 1	Euro 2	Euro 3	Euro 4		
BEQUILLE DOUBLE carré 8mm blanc	00000497	10	-	-	-	-	00200497	-	-	-	-	10	-
Paire de rosaces cylindre blanc	00090369	10	-	-	-	-	00190369	-	-	-	-	10	-
Paire de rosaces cylindre argent F1	00090383	10	-	-	-	-	00190383	-	-	-	-	10	-
BEQUILLE DOUBLE carré 8 mm noir 9005	00001499	10	-	-	-	-	00201499	-	-	-	-	10	-
Paire de rosaces cylindre noir 9005	00090384	10	-	-	-	-	00190384	-	-	-	-	10	-

⚠ Non stocké/Non-stored/Producto no estocado - 📦 Sur stock Europe Zone 1 et Zone 2, nous consulter pour délai d'approvisionnement - 📦 Epuisement/Stock depletion/Agotamiento del stock

Poignée de porte argent / BEQUILLE DOUBLE CRECY

PROTECT



GARANTIE



00000512



00000513

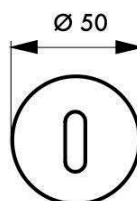
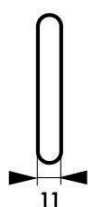
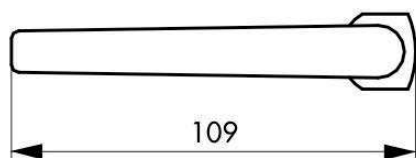

00000514

Description/Description/Descripción

Béquilles aluminium fondu. Carré acier 7 Fixation invisible par vis métaux. Pour porte ép. 45 mm maxi.

Casts aluminium handles. Steel Square 7 fixing by metal screws. For 45 mm maxi thickness door.

Brazos de aluminio fundido. Cuadrado acero de 7 Fijación invisible mediante tornillos para metal. Para puertas con un espesor máximo de 45 mm.

Finition/Finsih/Acabado

Anodisé argent F1

Silver anodized

Anodizado plata.

Utilisation/Use/Utilización

Pour porte à menuiserie métallique ou P.V.C.

Narrow steel or P.V.C doors

Para puerta con marco metálico o de PVC

Designation	Boite	Colis.	Prix	Sachet	Colis.	Prix	Brochable					Colis.	Prix
							France	Euro 1	Euro 2	Euro 3	Euro 4		
BEQUILLE DOUBLE CRECY carré 7 mm	00001270	10	-	-	-	-	-	-	-	-	-	-	-
Paire de ROSACES trou de clé	00000512	10	-	-	-	-	-	-	-	-	-	-	-
Paire de ROSACES trou de cylindre	00000513	10	-	-	-	-	-	-	-	-	-	-	-
Paire de ROSACES condamnation et décondamnation	00000514	10	-	-	-	-	-	-	-	-	-	-	-

Non stocké/Non-stored/Producto no estocado - Sur stock Europe Zone 1 et Zone 2, nous consulter pour délai d'approvisionnement - Epuisement/Stock depletion/Agotamiento del stock



Poignée de porte aspect inox ou blanc / BEQUILLE DOUBLE CHANTILLY

RESIST



GARANTIE



Description/Description/Descripción

Béquilles aluminium fondu. Carré acier 7Fixation invisible par vis métaux. Pour porte ép. 45 mm maxi.

Casts aluminium handles. Steel Square 7Invisible fixing by metal screws. For 45 mm maxi thickness door
Brazos de aluminio fundido. Cuadrado acero de 7Fijación invisible mediante tornillos para metal. Para puertas con un espesor máximo de 45 mm.

Finition/Finsih/Acabado

Anodisé inox, laqué blanc
Inox anodized, white lacquered
Anodizado color plata, lacado blanco

Utilisation/Use/Utilización

Pour porte à menuiserie métallique ou P.V.C.
Narrow steel or P.V.C doors
Para puerta con marco métallique o de PVC

Designation	Boite	Colis.	Prix	Sachet	Colis.	Prix	Brochable					Colis.	Prix
							France	Euro 1	Euro 2	Euro 3	Euro 4		
BEQUILLE double CHANTILLY anodisé inox 7 mm	00004180	10	-	-	-	-	-	-	-	-	-	-	-
BEQUILLE double CHANTILLY blanc carré 7 mm	00004185	10	-	-	-	-	-	-	-	-	-	-	-
ROSACE anodisé inox trou de clé (la paire)	00000515	10	-	-	-	-	-	-	-	-	-	-	-
ROSACE anodisé inox trou de cylindre (la paire)	00000516	10	-	-	-	-	-	-	-	-	-	-	-
ROSACE anodisé inox condamnation et décondamnation	00000517	10	-	-	-	-	-	-	-	-	-	-	-
ROSACE blanc trou de clé (la paire)	00000525	10	-	-	-	-	-	-	-	-	-	-	-
ROSACE blanc trou de cylindre (la paire)	00000526	10	-	-	-	-	-	-	-	-	-	-	-
ROSACE blanc condamnation et décondamnation	00000527	10	-	-	-	-	-	-	-	-	-	-	-

⚠ Non stocké/Non-stored/Producto no estocado - 📦 Sur stock Europe Zone 1 et Zone 2, nous consulter pour délai d'approvisionnement - 📦 Epuisement/Stock depletion/Agotamiento del stock

Béquille double argent, couleur F2, aspect inox / LUNAR

RESIST



by



GARANTIE

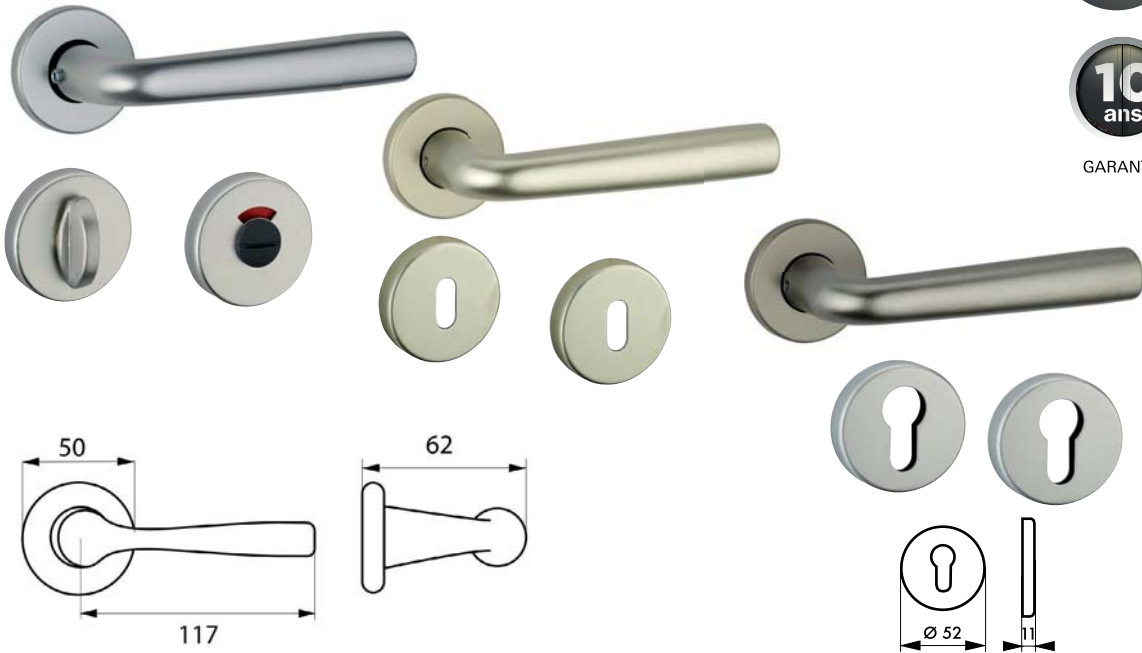

Description/Description/Descripción

Béquilles aluminium. Vis de fixation invisibles. Carré acier 7 mm.

Aluminium handles. Invisible fixing screws. Steel Square spindle 7 mm.

Brazos de aluminio. Tornillos de fijación invisibles. Cuadrado acero de 7 mm.

Finition/Finsih/Acabado

Argent F1 / couleur F2 / Aspect inox F9

Silver / color F2 / Stainless steel

Plata / color F2 / Aspecto inoxidable

Version/Option/Versión

Pour porte épaisseur 38-43mm

For 38-43mm door thickness

Para puerta de 38-43 mm

Designation	Boite	Colis.	Prix	Sachet	Colis.	Prix	Brochable					Colis.	Prix
							France	Euro 1	Euro 2	Euro 3	Euro 4		
Béquille Double LUNAR Argent F1	00066720	10	-	-	-	-	-	-	-	-	-	-	-
Béquille Double LUNAR couleur F2	00066721	10	-	-	-	-	-	-	-	-	-	-	-
Béquille Double LUNAR Aspect inox F9	00066722	10	-	-	-	-	-	-	-	-	-	-	-
Paire de rosaces aspect inox clé	-	-	-	00990665	6	-	-	-	-	-	-	-	-
Paire de rosaces aspect inox cylindre	-	-	-	00990666	6	-	-	-	-	-	-	-	-
Paire de rosaces aspect inox condam.	-	-	-	00990667	6	-	-	-	-	-	-	-	-
Paire de rosaces couleur F2 clé	-	-	-	00990320	6	-	00190320	-	-	-	-	10	-
Paire de rosaces couleur F2 cylindre	-	-	-	00990321	6	-	00190321	-	-	-	-	10	-
Paire de rosaces couleur F2 condamnation	-	-	-	00990322	6	-	00190322	-	-	-	-	10	-
Paire de rosaces argent clé	-	-	-	00990323	6	-	00190323	-	-	-	-	10	-
Paire de rosaces argent cylindre	-	-	-	00990324	6	-	00190324	-	-	-	-	10	-
Paire de rosaces argent condam.	-	-	-	00990325	6	-	00190325	-	-	-	-	10	-

Non stocké/Non-stored/Producto no estocado - Sur stock Europe Zone 1 et Zone 2, nous consulter pour délai d'approvisionnement - Epuement/Stock depletion/Agotamiento del stock



Poignetur rosace argent / CANOPEE - LADA

PROTECT



GARANTIE



00966810



00966814

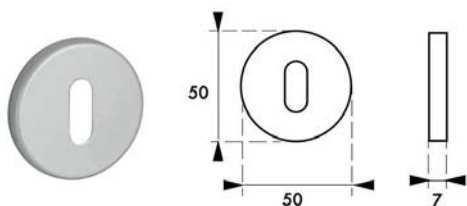
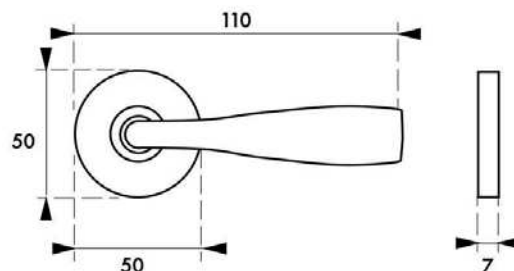
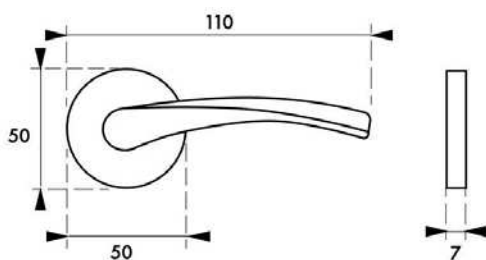

00966811

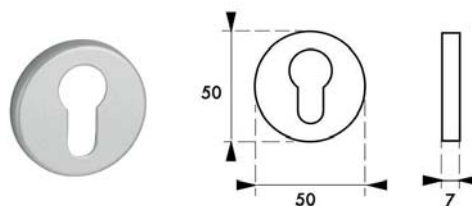

00966813

Description/Description/Descripción

Béquilles aluminium Vis de fixation invisibles. Carré acier 7mm.

Aluminium handles. Invisible fixing screws. Steel square spindle 7mm.

Brazos de aluminio. Tornillos de fijación invisibles. Cuadrado de acero de 7mm.

Finition/Finish/Acabado

Argent F1

Silver

Plata

Designation	Boite	Colis.	Prix	Sachet	Colis.	Prix	Brochable					Colis.	Prix
							France	Euro 1	Euro 2	Euro 3	Euro 4		
Poignée sur rosace CANOPEE finition argent F1	-	-	-	00966810	1	-	-	-	-	-	-	-	-
Poignée sur rosace LADA finition argent F1	-	-	-	00966814	1	-	-	-	-	-	-	-	-
Paire rosaces CANOPEE/ LADA ø 50 trou de clé, finition argent F1	-	-	-	00966811	1	-	-	-	-	-	-	-	-
Paire rosaces CANOPEE/ LADA ø 50 trou de cylindre, finition argent F1	-	-	-	00966813	1	-	-	-	-	-	-	-	-

⚠ Non stocké/Non-stored/Producto no estocado - ☑ Sur stock Europe Zone 1 et Zone 2, nous consulter pour délai d'approvisionnement - ☒ Epuisement/Stock depletion/Agotamiento del stock

Poignetur rosace argent / VELES

PROTECT



GARANTIE

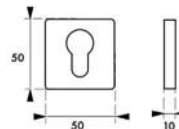
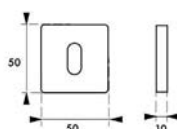
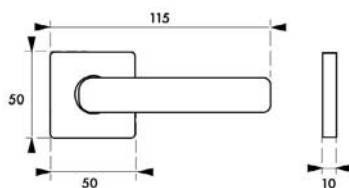

Description/Description/Descripción

Béquilles aluminium Vis de fixation invisibles. Carré acier 7mm.

Aluminium handles. Invisible fi xing screws. Steel square spindle 7mm.

Brazos de aluminio. Tornillos de fi jación invisibles. Cuadrado de acero de 7mm.

Finition/Finsih/Acabado

Argent F1

Silver

Plata

Designation	Boite	Colis.	Prix	Sachet	Colis.	Prix	Brochable					Colis.	Prix
							France	Euro 1	Euro 2	Euro 3	Euro 4		
Poignée sur rosace VELES, finition argent F1	-	-	-	00966817	1	-	-	-	-	-	-	-	-
Paire rosaces carré VELES 50x50, trou de clé, finition argent F1	-	-	-	00966818	1	-	-	-	-	-	-	-	-
Paire rosaces carré VELES 50x50 trou de cylindre, finition argent F1	-	-	-	00966819	1	-	-	-	-	-	-	-	-

Non stocké/Non-stored/Producto no estocado - Sur stock Europe Zone 1 et Zone 2, nous consulter pour délai d'approvisionnement - Epuisement/Stock depletion/Agotamiento del stock



Poignur rosace chromé satiné, noir mat / ZIBEL

PROTECT



GARANTIE

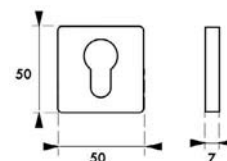
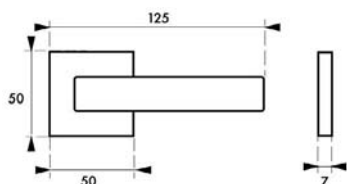

Description/Description/Descripción

Béquilles aluminium Vis de fixation invisibles. Carré acier 7mm. Ressort de rappel.

Aluminium handles. Invisible fixing screws. Steel square spindle 7mm. With spring.

Brazos de aluminio. Tornillos de fijación invisibles. Cuadrado de acero de 7mm. Con muelle. 7mm.

Finition/Finsih/Acabado

Chromé satiné / Noir mat.

Satin chrome / Black matt.

Cromado satinado / Negro mate.

Designation	Boite	Colis.	Prix	Sachet	Colis.	Prix	Brochable					Colis.	Prix
							France	Euro 1	Euro 2	Euro 3	Euro 4		
Poignée sur rosace ZIBEL chromé satiné	-	-	-	00966792	1	-	-	-	-	-	-	-	-
Paire rosaces carré 50x50 trou de cylindre, finition chrome satiné	-	-	-	00966801	1	-	-	-	-	-	-	-	-
Paire rosaces carré 50x50 trou de clé, finition chromé satiné	-	-	-	00966800	1	-	-	-	-	-	-	-	-
Paire rosaces carré 50x50 à condamnation, finition chromé satiné	-	-	-	00966802	1	-	-	-	-	-	-	-	-
Poignée sur rosace ZIBEL noir mat	-	-	-	00966793	1	-	-	-	-	-	-	-	-
Paire rosaces carré 50x50 trou de cylindre, finition noir mat	-	-	-	00966804	1	-	-	-	-	-	-	-	-
Paire rosaces carré 50x50 trou de clé, finition noir mat	-	-	-	00966803	1	-	-	-	-	-	-	-	-
Paire rosaces carré 50x50 à condamnation, finition noir mat	-	-	-	00966805	1	-	-	-	-	-	-	-	-

⚠ Non stocké/Non-stored/Producto no estocado - 📦 Sur stock Europe Zone 1 et Zone 2, nous consulter pour délai d'approvisionnement - 📦 Epuisement/Stock depletion/Agotamiento del stock

Poignée de porte / BEQUILLE DOUBLE



GARANTIE

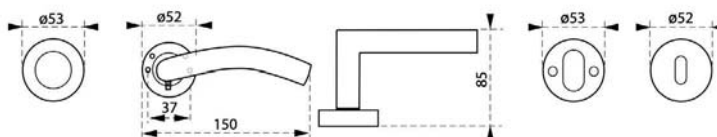
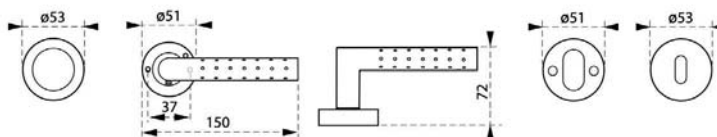

00990340

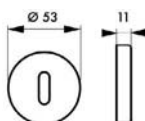

00990341

Description/Description/Descripción

Béquilles alliage fondu. Carré acier 7 mm. Ressort de rappel (sauf réf : 990304/290304). Vis métaux. Pour porte ép. 45 mm maxi.

Cast alloy handles. Steel Square spindle 7 mm. With spring (except ref : 990304/290304). Metal screws. For 45 mm maxi thickness door.

Brazos de aleación fundida Cuadrado acero de 7 mm. Com muelle (excepto : 990304/290304). Tornillos para metal. Para puertas con un espesor máximo de 45 mm

Finition/Finsih/Acabado

Nickelé satiné / laitonné / noir / inox
Satin nickel / brass plated steel / black / stainless steel
Niquel satinado / latonado / negro / inoxidable

Version/Option/Versión

Alliage 990301/990302 Acier 990303/990304 Inoxydable 990305/990306
Alloy 990301/990302 Steel 990303/990304 Stainless steel 990305/990306
Aleación 990301/990302 Acero 990303/990304 Acero inoxidable 990305/990306

Designation	Boite	Colis.	Prix	Sachet	Colis.	Prix	Brochable					Colis.	Prix
							France	Euro 1	Euro 2	Euro 3	Euro 4		
Béquille double inox 304	-	-	-	00990305	6	-	00290305	-	-	-	-	10	-
Béquille double inox 304	-	-	-	00990306	6	-	00290306	-	-	-	-	10	-
Paire de rosaces inox 304 clé	-	-	-	00990340	6	-	00190340	-	-	-	-	10	-
Paire de rosaces inox 304 cylindre	-	-	-	00990341	6	-	00190341	-	-	-	-	10	-
Paire de rosaces inox 304 condam.	-	-	-	00990342	6	-	00190342	-	-	-	-	10	-

Non stocké/Non-stored/Producto no estocado - Sur stock Europe Zone 1 et Zone 2, nous consulter pour délai d'approvisionnement - Epuement/Stock depletion/Agotamiento del stock



Poignée de porte nickelé satiné, nickelé brossé / BEQUILLE DOUBLE

ECO



GARANTIE

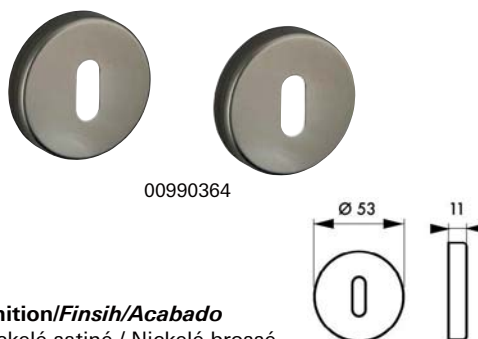
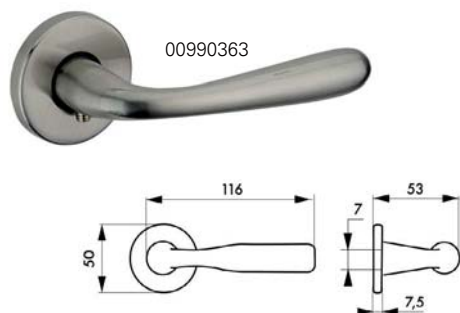
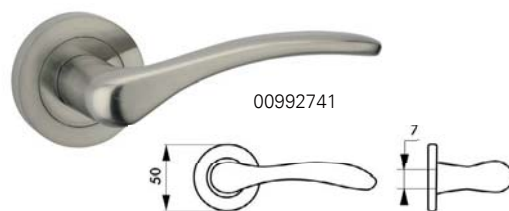
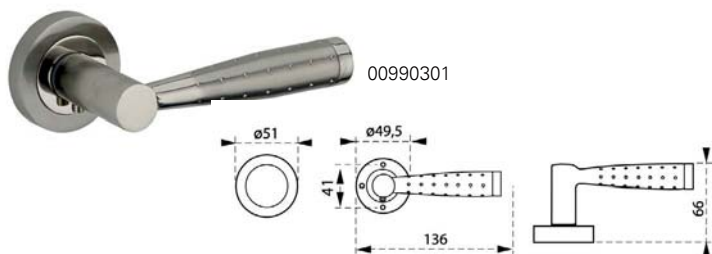

Description/Description/Descripción

Béquilles alliage fondu. Carré acier 7 mm. Ressort de rappel. Vis métaux. Pour porte ép. 45 mm maxi.
 Cast alloy handles. Steel Square spindle 7 mm. With spring. Metal screws. For 45 mm maxi thickness door.
 Brazos de aleación fundida Cuadrado acero de 7 mm. Com muelle. Tornillos para metal. Para puertas con un espesor máximo de 45 mm

Finition/Finish/Acabado

Nickelé satiné / Nickelé brossé
 Satin nickel / Nickel brush
 Niquel satinado / Niquel cepillado

Versión/Option/Versión

Acier 990303
 Steel 990303
 Acero 990303

Designation	Boite	Colis.	Prix	Sachet	Colis.	Prix	Brochable					Colis.	Prix
							France	Euro 1	Euro 2	Euro 3	Euro 4		
Béquille double nickelé satiné	-	-	-	00990301	6	-	00290301	-	-	-	-	10	-
Béquille double nickelé satiné	-	-	-	00990303	6	-	00290303	-	-	-	-	10	-
Béquille double nickelée brossée	-	-	-	00992741	6	-	-	-	-	-	-	-	-
Béquille double nickelée brossée JUNON	-	-	-	00990363	6	-	00290363	-	-	-	-	10	-
Paire de rosaces nickelé brossé clé	-	-	-	00990364	6	-	00190364	-	-	-	-	10	-
Paire de rosaces nickelé brossé cylindre	-	-	-	00990365	6	-	00190365	-	-	-	-	10	-
Paire de rosaces nickelé brossé condamnation	-	-	-	00990366	6	-	00190366	-	-	-	-	10	-

NS Non stocké/Non-stored/Producto no estocado - S Sur stock Europe Zone 1 et Zone 2, nous consulter pour délai d'approvisionnement - E Epuisement/Stock depletion/Agotamiento del stock

Poignée de porte laitonée / BEQUILLE DOUBLE PROTECT



GARANTIE



00990300

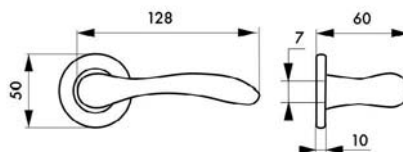

00990302

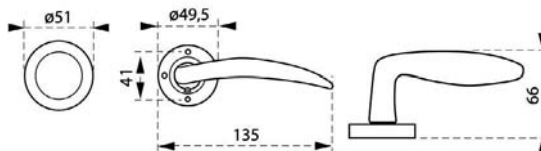

Description/Description/Descripción

Rosaces alliage fondu. Béquilles alliage fondu. Carré acier 7mm. Vis métaux.

Cast alloy plates. Cast alloy handles. Square 7mm. Metal screws.

Placas de aleación fundida. Brazos de aleación fundida. Cuadrado acero de 7mm. Tornillos para metal.

Finition/Finsih/Acabado

Laitonné.

Brass plated

Latonado.

Version/Option/Versión

990302 Ressort de rappel.

990302 With spring

990302 Com muelle.

Designation	Boite	Colis.	Prix	Sachet	Colis.	Prix	Brochable					Colis.	Prix
							France	Euro 1	Euro 2	Euro 3	Euro 4		
Béquille double laitonée	-	-	-	00990300	6	-	00290300	-	-	-	-	10	-
Béquille double laitoné	-	-	-	00990302	6	-	00290302	-	-	-	-	10	-

Poignée de porte noire / BEQUILLE DOUBLE ECO



GARANTIE

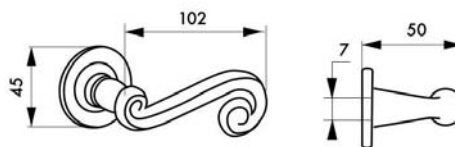

Description/Description/Descripción

Acier. Carré acier 7 mm. Vis métaux. Pour porte ép. 45 mm maxi.

Steel. Steel Square spindle 7 mm. With spring. Metal screws. For 45 mm maxi thickness door.

Acero. Cuadrado acero de 7 mm. Com muelle. Tornillos para metal. Para puertas con un espesor máximo de 45 mm

Finition/Finsih/Acabado

Noir

Black

Negro

Designation	Boite	Colis.	Prix	Sachet	Colis.	Prix	Brochable					Colis.	Prix
							France	Euro 1	Euro 2	Euro 3	Euro 4		
Béquille double noir	-	-	-	00990304	6	-	00290304	-	-	-	-	10	-

Non stocké/Non-stored/Producto no estocado - Sur stock Europe Zone 1 et Zone 2, nous consulter pour délai d'approvisionnement - Epuisement/Stock depletion/Agotamiento del stock

Béquille double inox RESIST



GARANTIE

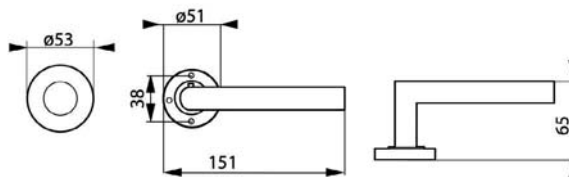

Description/Description/Descripción

Béquilles inox 304. Vis de invisible. Carracier 7 mm.
Stainless steel 304 handles. Invisible xing screws. Steel
Square spindle 7 mm.
Brazos de acero inoxidable. Tornillos de jacion invisibles.
Cuadrado acero de 7 mm.

Finition/Finsih/Acabado

Aspect inox.
Stainless steel appearance.
Aspecto acero inoxidable.

Designation	Boite	Colis.	Prix	Sachet	Colis.	Prix	Brochable					Colis.	Prix
							France	Euro 1	Euro 2	Euro 3	Euro 4		
Béquille double inox	00067502	10	-	-	-	-	-	-	-	-	-	-	-
Paire de rosaces rondes inox - CP	00067508	10	-	-	-	-	-	-	-	-	-	-	-

Béquille double inox RESIST



GARANTIE

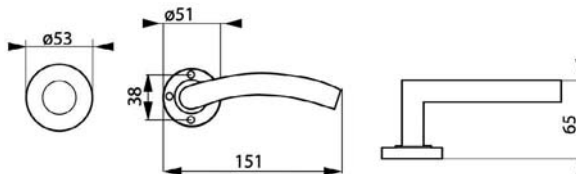

Description/Description/Descripción

Béquilles inox 304. Vis de invisible. Carracier 7 mm.
Stainless steel 304 handles. Invisible xing screws. Steel
Square spindle 7 mm.
Brazos de acero inoxidable. Tornillos de jacion invisibles.
Cuadrado acero de 7 mm.

Finition/Finsih/Acabado

Aspect inox.
Stainless steel appearance.
Aspecto acero inoxidable.

Designation	Boite	Colis.	Prix	Sachet	Colis.	Prix	Brochable					Colis.	Prix
							France	Euro 1	Euro 2	Euro 3	Euro 4		
Béquille double inox	00067503	10	-	-	-	-	-	-	-	-	-	-	-
Paire de rosaces rondes inox - CP	00067508	10	-	-	-	-	-	-	-	-	-	-	-

Béquille double inox RESIST



GARANTIE

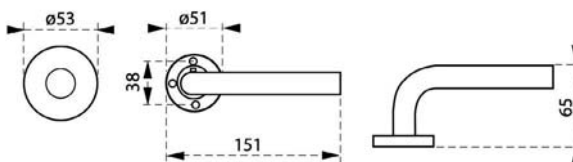

Description/Description/Descripción

Béquilles inox 304. Vis de invisible. Carracier 7 mm.
Stainless steel 304 handles. Invisible xing screws. Steel
Square spindle 7 mm.
Brazos de acero inoxidable. Tornillos de jacion invisibles.
Cuadrado acero de 7 mm.

Finition/Finsih/Acabado

Aspect inox.
Stainless steel appearance.
Aspecto acero inoxidable.

Designation	Boite	Colis.	Prix	Sachet	Colis.	Prix	Brochable					Colis.	Prix
							France	Euro 1	Euro 2	Euro 3	Euro 4		
Béquille double inox	00067500	10	-	-	-	-	-	-	-	-	-	-	-
Paire de rosaces rondes inox - CP	00067508	10	-	-	-	-	-	-	-	-	-	-	-

Béquille double inox RESIST



GARANTIE

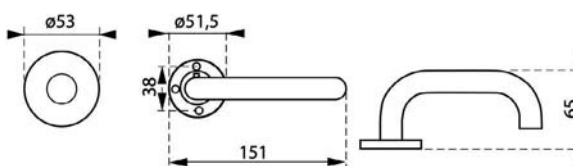

Description/Description/Descripción

Béquilles inox 304. Vis de invisible. Carracier 7 mm.
Stainless steel 304 handles. Invisible xing screws. Steel
Square spindle 7 mm.
Brazos de acero inoxidable. Tornillos de jacion invisibles.
Cuadrado acero de 7 mm.

Finition/Finsih/Acabado

Aspect inox.
Stainless steel appearance.
Aspecto acero inoxidable.

Designation	Boite	Colis.	Prix	Sachet	Colis.	Prix	Brochable					Colis.	Prix
							France	Euro 1	Euro 2	Euro 3	Euro 4		
Béquille double inox	00067501	10	-	-	-	-	-	-	-	-	-	-	-
Paire de rosaces rondes inox - CP	00067508	10	-	-	-	-	-	-	-	-	-	-	-

Non stocké/Non-stored/Producto no estocado - Sur stock Europe Zone 1 et Zone 2, nous consulter pour délai d'approvisionnement - Epuement/Stock depletion/Agotamiento del stock



Béquille double inox RESIST



GARANTIE

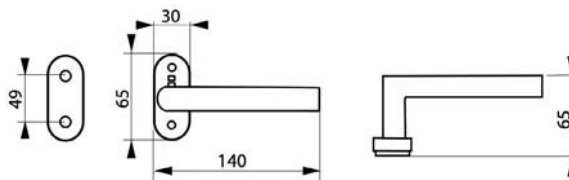

Description/Description/Descripción

Béquilles inox 304. Vis de invisible. Carracier 7 mm.
Stainless steel 304 handles. Invisible xing screws. Steel
Square spindle 7 mm.
Brazos de acero inoxidable. Tornillos de jacion invisibles.
Cuadrado acero de 7 mm.

Finition/Finsih/Acabado

Aspect inox.
Stainless steel appearance.
Aspecto acero inoxidable.

Designation	Boite	Colis.	Prix	Sachet	Colis.	Prix	Brochable					Colis.	Prix
							France	Euro 1	Euro 2	Euro 3	Euro 4		
Béquille double inox	00067506	10	-	-	-	-	-	-	-	-	-	-	-
Paire de rosaces ovales 65x30mm inox - CP	00067509	10	-	-	-	-	-	-	-	-	-	-	-

Béquille double inox RESIST



GARANTIE

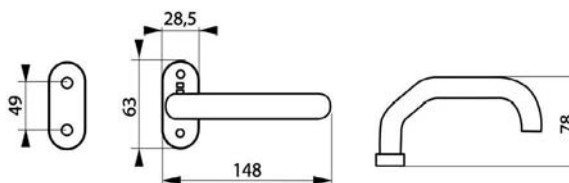

Description/Description/Descripción

Béquilles inox 304. Vis de invisible. Carracier 7 mm.
Stainless steel 304 handles. Invisible xing screws. Steel
Square spindle 7 mm.
Brazos de acero inoxidable. Tornillos de jacion invisibles.
Cuadrado acero de 7 mm.

Finition/Finsih/Acabado

Aspect inox.
Stainless steel appearance.
Aspecto acero inoxidable.

Designation	Boite	Colis.	Prix	Sachet	Colis.	Prix	Brochable					Colis.	Prix
							France	Euro 1	Euro 2	Euro 3	Euro 4		
Béquille double inox	00067507	10	-	-	-	-	-	-	-	-	-	-	-
Paire de rosaces ovales 65x30mm inox - CP	00067509	10	-	-	-	-	-	-	-	-	-	-	-

Ⓜ Non stocké/Non-stored/Producto no estocado - ☑ Sur stock Europe Zone 1 et Zone 2, nous consulter pour délai d'approvisionnement - ☒ Epuisement/Stock depletion/Agotamiento del stock

Béquille double inox RESIST



GARANTIE

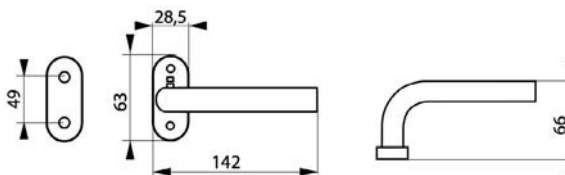

Description/Description/Descripción

Béquilles inox 304. Vis de invisible. Carracier 7 mm.
Stainless steel 304 handles. Invisible xing screws. Steel
Square spindle 7 mm.
Brazos de acero inoxidable. Tornillos de jacion invisibles.
Cuadrado acero de 7 mm.

Finition/Finsih/Acabado

Aspect inox.
Stainless steel appearance.
Aspecto acero inoxidable.

Designation	Boite	Colis.	Prix	Sachet	Colis.	Prix	Brochable					Colis.	Prix
							France	Euro 1	Euro 2	Euro 3	Euro 4		
Béquille double inox	00067504	10	-	-	-	-	-	-	-	-	-	-	-
Paire de rosaces ovales 65x30mm inox - CP	00067509	10	-	-	-	-	-	-	-	-	-	-	-

Béquille double inox RESIST



GARANTIE



Description/Description/Descripción

Béquilles inox 304. Vis de invisible. Carracier 7 mm.
Stainless steel 304 handles. Invisible xing screws. Steel
Square spindle 7 mm.
Brazos de acero inoxidable. Tornillos de jacion invisibles.
Cuadrado acero de 7 mm.

Finition/Finsih/Acabado

Aspect inox.
Stainless steel appearance.
Aspecto acero inoxidable.

Designation	Boite	Colis.	Prix	Sachet	Colis.	Prix	Brochable					Colis.	Prix
							France	Euro 1	Euro 2	Euro 3	Euro 4		
Béquille double inox	00067505	10	-	-	-	-	-	-	-	-	-	-	-
Paire de rosaces ovales 65x30mm inox - CP	00067509	10	-	-	-	-	-	-	-	-	-	-	-

Non stocké/Non-stored/Producto no estocado - Sur stock Europe Zone 1 et Zone 2, nous consulter pour délai d'approvisionnement - Epuement/Stock depletion/Agotamiento del stock



Béquille double inox-cuivre RESIST

STERIALL
by THIRARD



10
ans

GARANTIE

Alliage de cuivre antimicrobien,
élimine les virus et les bactéries



Testé en laboratoire
Conforme à la norme NF S90-700

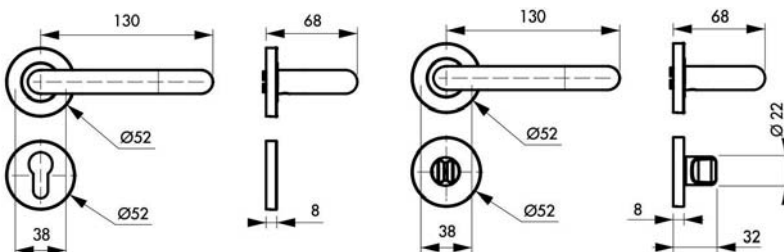

Description/Description/Descripción

Rosaces inox. Béquilles cuivre. carré acier 7 mm. Ressort de rappel. Vis métaux sécables.

Stainless steel plates. Copper handles. Steel spindle 7 mm. With spring. Metal screws.

Placas de acero inoxidable. Brazos de cobre. acero de 7 mm. Com muelle. Tornillos para metal.

Finition/Finish/Acabado

Inox brossé-cuivre

Stainless steel brushed-Copper

Acero inoxidable cepillado-Cobre

Version/Option/Versión

Avec bouton de condamnation pour porte de salle de bains et W-C. Avec trou de cylindre européen.

With locking knob for bathroom doors and WC. With european cylinder hole.

Con botón de condenación para puerta de cuartos de baño y WC. Con orificio de cilindro europeo.

Designation	Boite	Colis.	Prix	Sachet	Colis.	Prix	Brochable					Colis.	Prix
							France	Euro 1	Euro 2	Euro 3	Euro 4		
Béquille cuivre - rosaces trou de cylindre	00019511	1	-	-	-	-	-	-	-	-	-	-	-
Béquille cuivre - rosaces à condamnation	00019711	1	-	-	-	-	-	-	-	-	-	-	-
Produit nettoyant / régénérant 750 ml + 2 tampons cleaner	00019110	1	-	-	-	-	-	-	-	-	-	-	-

⚠ Non stocké/Non-stored/Producto no estocado - 📦 Sur stock Europe Zone 1 et Zone 2, nous consulter pour délai d'approvisionnement - 📦 Epuisement/Stock depletion/Agotamiento del stock

Poignée sur rosace chromé satiné, noir mat, nickelé satiné / BOSTON

PROTECT



GARANTIE

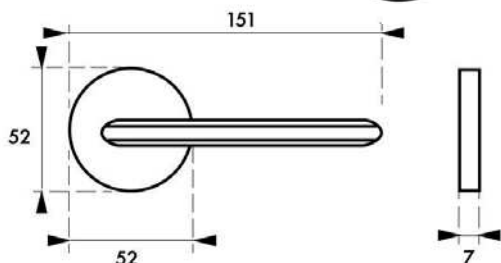

Description/Description/Descripción

Béquilles alliage. Vis de fixation invisibles. Carré acier 7mm. Ressort de rappel.

Alloy handles. Invisible fixing screws. Steel square spindle 7mm. With spring.

Brazos de aleación. Tornillos de fijación invisibles. Cuadrado de acero de 7mm. Con muelle.

Finition/Finish/Acabado

Chromé satiné / Noir mat / Nickelé satiné.

Satin chrome / Black matt / Satin nickel.

Cromado satinado/ Negro mate / Niquel satinado.

Designation	Boîte	Colis.	Prix	Sachet	Colis.	Prix	Brochable					Colis.	Prix
							France	Euro 1	Euro 2	Euro 3	Euro 4		
Poignée sur rosace BOSTON chrome satiné	00066741	1	-	-	-	-	-	-	-	-	-	-	-
Paire rosaces ronde ø 50 trou de cylindre, chrome satiné	-	-	-	00966772	1	-	-	-	-	-	-	-	-
Paire rosaces ronde ø 50 trou de clé, chrome satiné	-	-	-	00966776	1	-	-	-	-	-	-	-	-
Paire rosaces ronde ø 50 à condamnation, chrome satiné	-	-	-	00966786	1	-	-	-	-	-	-	-	-
Poignée sur rosace BOSTON noir mat	00066742	1	-	-	-	-	-	-	-	-	-	-	-
Paire rosaces ronde ø 50 trou de cylindre, noir mat	-	-	-	00966771	1	-	-	-	-	-	-	-	-
Paire rosaces ronde ø 50 trou de clé, noir mat	-	-	-	00966775	1	-	-	-	-	-	-	-	-
Paire rosaces ronde ø 50 à condamnation, noir mat	-	-	-	00966785	1	-	-	-	-	-	-	-	-
Poignée sur rosace BOSTON nickel satiné	00066743	1	-	-	-	-	-	-	-	-	-	-	-
Paire rosaces ronde ø 50 trou de cylindre, nickel satiné	-	-	-	00966770	1	-	-	-	-	-	-	-	-
Paire rosaces ronde ø 50 trou de clé, nickel satiné	-	-	-	00966774	1	-	-	-	-	-	-	-	-
Paire rosaces ronde ø 50 à condamnation, nickel satiné	-	-	-	00966784	1	-	-	-	-	-	-	-	-

Non stocké/Non-stored/Producto no estocado - Sur stock Europe Zone 1 et Zone 2, nous consulter pour délai d'approvisionnement - Epuisement/Stock depletion/Agotamiento del stock



Poignée sur rosace chromé satiné, nickelé satiné / SOLIS

PROTECT

**FROSIO
BORTOLO
1952**
by **THIRARD**



GARANTIE

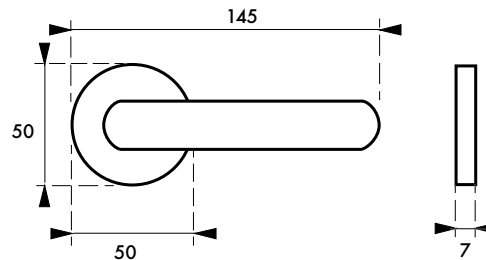

Description/Description/Descripción

Béquilles alliage. Vis de fixation invisibles. Carré acier 7mm. Ressort de rappel.

Alloy handles. Invisible fixing screws. Steel square spindle 7mm. With spring.

Brazos de aleación. Tornillos de fijación invisibles. Cuadrado de acero de 7mm. Con muelle.

Finition/Finish/Acabado

Chromé satiné / Nickelé satiné.

Satin chrome / Satin nickel.

Cromado satinado/ Niquel satinado.

Designation	Boite	Colis.	Prix	Sachet	Colis.	Prix	Brochable					Colis.	Prix
							France	Euro 1	Euro 2	Euro 3	Euro 4		
Poignée sur rosace SOLIS chrome satiné	00066750	1	-	-	-	-	-	-	-	-	-	-	-
Paire rosaces ronde ø 50 trou de cylindre, chrome satiné	-	-	-	00966772	1	-	-	-	-	-	-	-	-
Paire rosaces ronde ø 50 trou de clé, chrome satiné	-	-	-	00966776	1	-	-	-	-	-	-	-	-
Paire rosaces ronde ø 50 à condamnation, chrome satiné	-	-	-	00966786	1	-	-	-	-	-	-	-	-
Poignée sur rosace SOLIS nickel satiné	00066751	1	-	-	-	-	-	-	-	-	-	-	-
Paire rosaces ronde ø 50 trou de cylindre, nickel satiné	-	-	-	00966770	1	-	-	-	-	-	-	-	-
Paire rosaces ronde ø 50 trou de clé, nickel satiné	-	-	-	00966774	1	-	-	-	-	-	-	-	-
Paire rosaces ronde ø 50 à condamnation, nickel satiné	-	-	-	00966784	1	-	-	-	-	-	-	-	-

Ⓝ Non stocké/Non-stored/Producto no estocado - ☑ Sur stock Europe Zone 1 et Zone 2, nous consulter pour délai d'approvisionnement - ☒ Epuisement/Stock depletion/Agotamiento del stock

Poignée sur rosace chromé poli, chromé satiné / LUXOR

PROTECT



GARANTIE

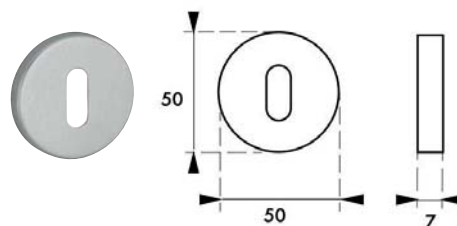
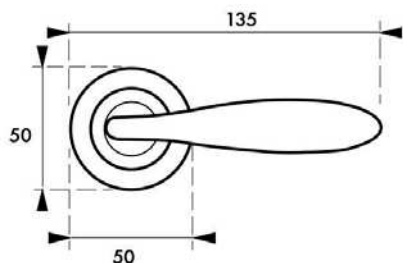

Description/Description/Descripción

Béquilles alliage. Vis de fixation invisibles. Carré acier 7mm. Ressort de rappel.

Alloy handles. Invisible fixing screws. Steel square spindle 7mm. With spring.

Brazos de aleación. Tornillos de fijación invisibles. Cuadrado de acero de 7mm. Con muelle.

Finition/Finish/Acabado

Chromé poli / Chromé satiné.

Chrome plated / Satin chrome.

Cromado pulido/ Cromado satinado.

Designation	Boite	Colis.	Prix	Sachet	Colis.	Prix	Brochable					Colis.	Prix
							France	Euro 1	Euro 2	Euro 3	Euro 4		
Poignée sur rosace LUXOR chrome brillant	00066760	1	-	-	-	-	-	-	-	-	-	-	-
Paire rosaces ronde ø 50 trou de cylindre, chrome brillant	-	-	-	00966773	1	-	-	-	-	-	-	-	-
Paire rosaces ronde ø 50 trou de clé, chrome brillant	-	-	-	00966777	1	-	-	-	-	-	-	-	-
Paire rosaces ronde ø 50 à condamnation, chrome brillant	-	-	-	00966787	1	-	-	-	-	-	-	-	-
Poignée sur rosace LUXOR chrome satiné	00066761	1	-	-	-	-	-	-	-	-	-	-	-
Paire rosaces ronde ø 50 trou de cylindre, chrome satiné	-	-	-	00966772	1	-	-	-	-	-	-	-	-
Paire rosaces ronde ø 50 trou de clé, chrome satiné	-	-	-	00966776	1	-	-	-	-	-	-	-	-
Paire rosaces ronde ø 50 à condamnation, chrome satiné	-	-	-	00966786	1	-	-	-	-	-	-	-	-

Non stocké/Non-stored/Producto no estocado - Sur stock Europe Zone 1 et Zone 2, nous consulter pour délai d'approvisionnement - Epuement/Stock depletion/Agotamiento del stock



Poignée sur rosace chromé satiné / GRID

PROTECT



GARANTIE

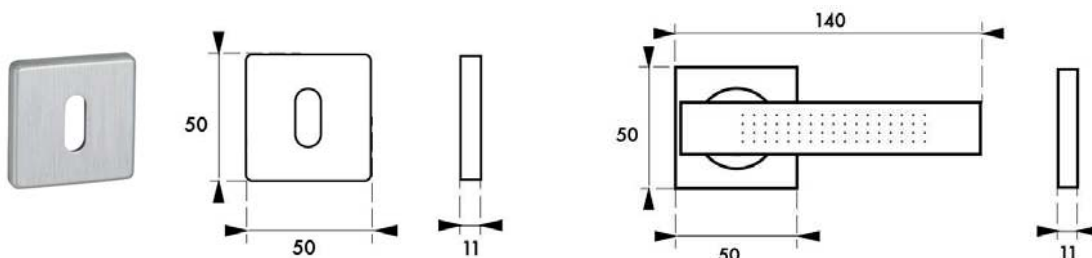

Description/Description/Descripción

Béquilles alliage. Vis de fixation invisibles. Carré acier 7mm. Ressort de rappel.

Alloy handles. Invisible fixing screws. Steel square spindle 7mm. With spring.

Brazos de aleación. Tornillos de fijación invisibles. Cuadrado de acero de 7mm. Con muelle.

Finition/Finish/Acabado

Chromé satiné.

Satin chrome.

Cromado satinado.

Designation	Boite	Colis.	Prix	Sachet	Colis.	Prix	Brochable					Colis.	Prix
							France	Euro 1	Euro 2	Euro 3	Euro 4		
Poignée sur rosace GRID chromé satiné	-	-	-	00966791	1	-	-	-	-	-	-	-	-
Paire rosaces carré 50x50 trou de cylindre, finition chrome satiné	-	-	-	00966801	1	-	-	-	-	-	-	-	-
Paire rosaces carré 50x50 trou de clé, finition chromé satiné	-	-	-	00966800	1	-	-	-	-	-	-	-	-
Paire rosaces carré 50x50 à condamnation, finition chromé satiné	-	-	-	00966802	1	-	-	-	-	-	-	-	-

⚠ Non stocké/Non-stored/Producto no estocado - 📦 Sur stock Europe Zone 1 et Zone 2, nous consulter pour délai d'approvisionnement - 📦 Epuisement/Stock depletion/Agotamiento del stock

Poignée sur rosace chromé poli, noir mat / MONZA

PROTECT



GARANTIE

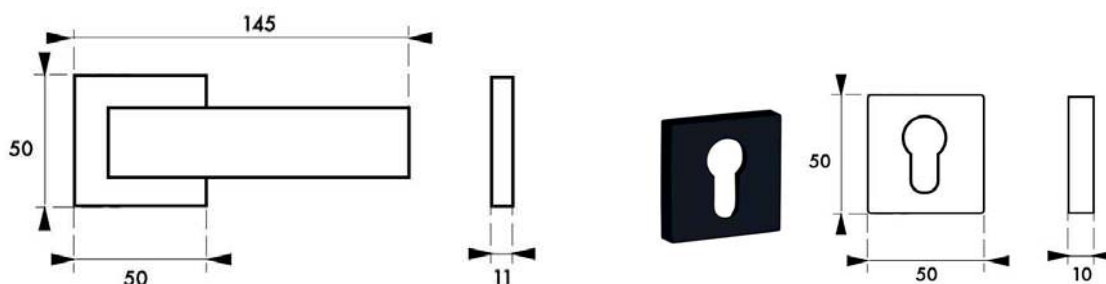

Description/Description/Descripción

Béquilles alliage. Vis de fixation invisibles. Carré acier 7mm. Ressort de rappel.

Alloy handles. Invisible fixing screws. Steel square spindle 7mm. With spring.

Brazos de aleación. Tornillos de fijación invisibles. Cuadrado de acero de 7mm. Con muelle.

Finition/Finish/Acabado

Chromé poli / Noir mat.

Chrome plated / Black matt.

Cromado pulido / Negro mate.

Designation	Boite	Colis.	Prix	Sachet	Colis.	Prix	Brochable					Colis.	Prix
							France	Euro 1	Euro 2	Euro 3	Euro 4		
Poignée sur rosace MONZA chrome brillant	00066748	1	-	-	-	-	-	-	-	-	-	-	-
Paire rosaces carré 50x50 trou de cylindre, chrome brillant	-	-	-	00966780	1	-	-	-	-	-	-	-	-
Paire rosaces carré 50x50 trou de clé, chrome brillant	-	-	-	00966783	1	-	-	-	-	-	-	-	-
Paire rosaces carré 50x50 à condamnation, chrome brillant	-	-	-	00966790	1	-	-	-	-	-	-	-	-
Poignée sur rosace MONZA noir mat	00066749	1	-	-	-	-	-	-	-	-	-	-	-
Paire rosaces carré 50x50 trou de cylindre, noir mat	-	-	-	00966778	1	-	-	-	-	-	-	-	-
Paire rosaces carré 50x50 trou de clé, noir mat	-	-	-	00966781	1	-	-	-	-	-	-	-	-
Paire rosaces carré 50x50 à condamnation, noir mat	-	-	-	00966788	1	-	-	-	-	-	-	-	-

Non stocké/Non-stored/Producto no estocado - Sur stock Europe Zone 1 et Zone 2, nous consulter pour délai d'approvisionnement - Epuement/Stock depletion/Agotamiento del stock



Poignée sur rosace chromé satiné, noir mat / MODENA

PROTECT

**FROSIO
BORTOLO
1952**
by **THIRARD**



GARANTIE

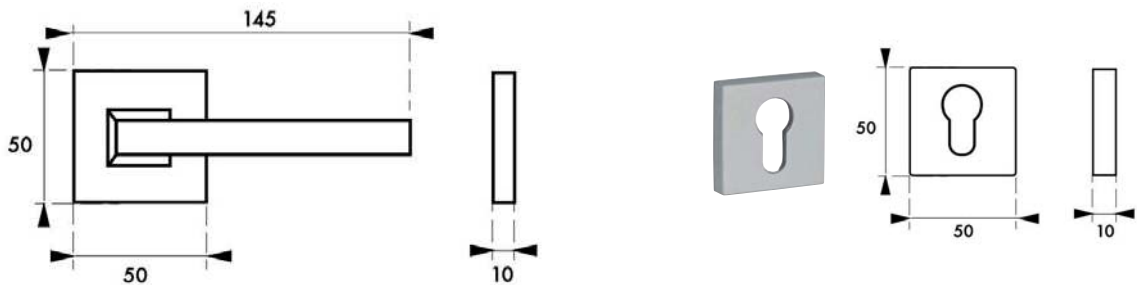

Description/Description/Descripción

Béquilles alliage. Vis de fixation invisibles. Carré acier 7mm. Ressort de rappel.

Alloy handles. Invisible fixing screws. Steel square spindle 7mm. With spring.

Brazos de aleación. Tornillos de fijación invisibles. Cuadrado de acero de 7mm. Con muelle.

Finition/Finish/Acabado

Chromé satiné / Noir mat.

Satin chrome / Black matt.

Cromado satinado / Negro mate.

Designation	Boite	Colis.	Prix	Sachet	Colis.	Prix	Brochable					Colis.	Prix
							France	Euro 1	Euro 2	Euro 3	Euro 4		
Poignée sur rosace MODENA chrome satiné	00066746	1	-	-	-	-	-	-	-	-	-	-	-
Paire rosaces carré 50x50 trou de cylindre, chrome satiné	-	-	-	00966779	1	-	-	-	-	-	-	-	-
Paire rosaces carré 50x50 trou de clé, chrome satiné	-	-	-	00966782	1	-	-	-	-	-	-	-	-
Paire rosaces carré 50x50 à condamnation, chrome satiné	-	-	-	00966789	1	-	-	-	-	-	-	-	-
Poignée sur rosace MODENA noir mat	00066747	1	-	-	-	-	-	-	-	-	-	-	-
Paire rosaces carré 50x50 trou de cylindre, noir mat	-	-	-	00966778	1	-	-	-	-	-	-	-	-
Paire rosaces carré 50x50 trou de clé, noir mat	-	-	-	00966781	1	-	-	-	-	-	-	-	-
Paire rosaces carré 50x50 à condamnation, noir mat	-	-	-	00966788	1	-	-	-	-	-	-	-	-

⚠ Non stocké/Non-stored/Producto no estocado - 📦 Sur stock Europe Zone 1 et Zone 2, nous consulter pour délai d'approvisionnement - 🇪🇺 Epuisement/Stock depletion/Agotamiento del stock

Poignée sur rosace chromé satiné, noir mat / GINEVRA

PROTECT



GARANTIE

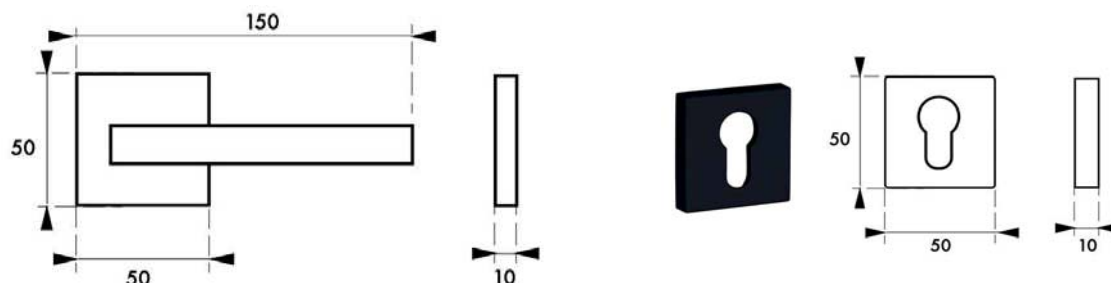

Description/Description/Descripción

Béquilles alliage. Vis de fixation invisibles. Carré acier 7mm. Ressort de rappel.

Alloy handles. Invisible fixing screws. Steel square spindle 7mm. With spring.

Brazos de aleación. Tornillos de fijación invisibles. Cuadrado de acero de 7mm. Con muelle.

Finition/Finish/Acabado

Chromé satiné / Noir mat.

Satin chrome / Black matt.

Cromado satinado / Negro mate.

Designation	Boite	Colis.	Prix	Sachet	Colis.	Prix	Brochable					Colis.	Prix
							France	Euro 1	Euro 2	Euro 3	Euro 4		
Poignée sur rosace GINEVRA chrome satiné	00066744	1	-	-	-	-	-	-	-	-	-	-	-
Paire rosaces carré 50x50 trou de cylindre, chrome satiné	-	-	-	00966779	1	-	-	-	-	-	-	-	-
Paire rosaces carré 50x50 trou de clé, chrome satiné	-	-	-	00966782	1	-	-	-	-	-	-	-	-
Paire rosaces carré 50x50 à condamnation, chrome satiné	-	-	-	00966789	1	-	-	-	-	-	-	-	-
Poignée sur rosace GINEVRA noir mat	00066745	1	-	-	-	-	-	-	-	-	-	-	-
Paire rosaces carré 50x50 trou de cylindre, noir mat	-	-	-	00966778	1	-	-	-	-	-	-	-	-
Paire rosaces carré 50x50 trou de clé, noir mat	-	-	-	00966781	1	-	-	-	-	-	-	-	-
Paire rosaces carré 50x50 à condamnation, noir mat	-	-	-	00966788	1	-	-	-	-	-	-	-	-

Non stocké/Non-stored/Producto no estocado - Sur stock Europe Zone 1 et Zone 2, nous consulter pour délai d'approvisionnement - Epuement/Stock depletion/Agotamiento del stock



Poignée sur rosace chromé poli/satin / MIRELLA 2

PROTECT

**FROSIO
BORTOLO
1952**
by **THIRARD**



GARANTIE

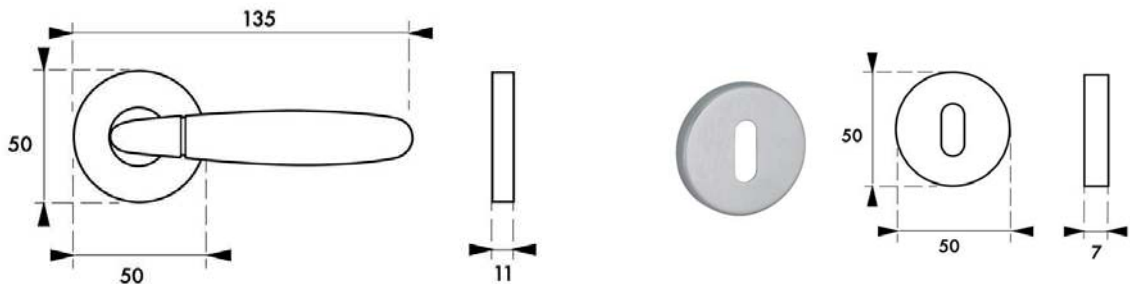

Description/Description/Descripción

Béquilles laiton. Vis de fixation invisibles. Carré acier 7mm. Ressort de rappel.
Brass handles. Invisible fixing screws. Steel square spindle 7mm. With spring.
 Brazos de latón. Tornillos de fijación invisibles. Cuadrado de acero de 7mm. Con muelle.

Finition/Finsih/Acabado

Chromé poli/satin.
Chrome plated/satin.
 Cromado pulido/satinado.

Designation	Boite	Colis.	Prix	Sachet	Colis.	Prix	Brochable					Colis.	Prix
							France	Euro 1	Euro 2	Euro 3	Euro 4		
Poignée sur rosace MIRELLA 2 chromé satin/brillant	00066752	1	-	-	-	-	-	-	-	-	-	-	-
Paire rosaces ronde ø 50 trou de cylindre, chrome satiné	-	-	-	00966772	1	-	-	-	-	-	-	-	-
Paire rosaces ronde ø 50 trou de clé, chrome satiné	-	-	-	00966776	1	-	-	-	-	-	-	-	-
Paire rosaces ronde ø 50 à condamnation, chrome satiné	-	-	-	00966786	1	-	-	-	-	-	-	-	-

⚠ Non stocké/Non-stored/Producto no estocado - 📦 Sur stock Europe Zone 1 et Zone 2, nous consulter pour délai d'approvisionnement - 📦 Epuisement/Stock depletion/Agotamiento del stock

Poignée sur rosace chromé poli, chromé satiné / MAXIMA

PROTECT



GARANTIE

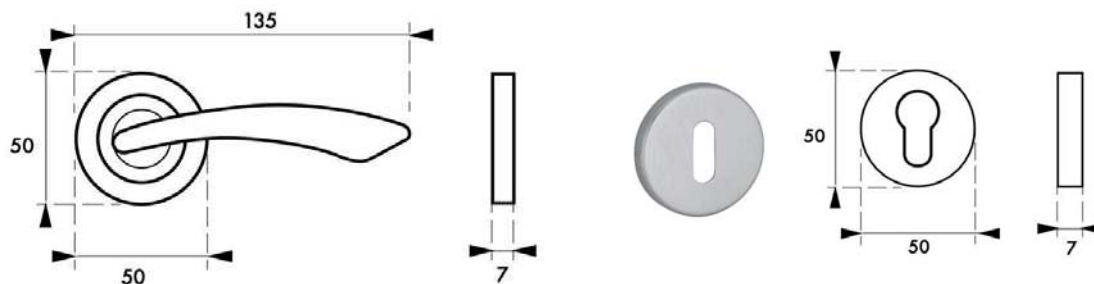

Description/Description/Descripción

Béquilles alliage. Vis de fixation invisibles. Carré acier 7mm. Ressort de rappel.
 Alloy handles. Invisible fixing screws. Steel square spindle 7mm. With spring.
 Brazos de aleación. Tornillos de fijación invisibles. Cuadrado de acero de 7mm. Con muelle.

Finition/Finsih/Acabado

Chromé poli / Chromé satiné.
 Chrome plated / Satin chrome.
 Cromado pulido/ Cromado satinado.

Designation	Boite	Colis.	Prix	Sachet	Colis.	Prix	Brochable					Colis.	Prix
							France	Euro 1	Euro 2	Euro 3	Euro 4		
Poignée sur rosace MAXIMA chrome brillant	00066762	1	-	-	-	-	-	-	-	-	-	-	-
Paire rosaces ronde ø 50 trou de cylindre, chrome brillant	-	-	-	00966773	1	-	-	-	-	-	-	-	-
Paire rosaces ronde ø 50 trou de clé, chrome brillant	-	-	-	00966777	1	-	-	-	-	-	-	-	-
Paire rosaces ronde ø 50 à condamnation, chrome brillant	-	-	-	00966787	1	-	-	-	-	-	-	-	-
Poignée sur rosace MAXIMA chrome satiné	00066763	1	-	-	-	-	-	-	-	-	-	-	-
Paire rosaces ronde ø 50 trou de cylindre, chrome satiné	-	-	-	00966772	1	-	-	-	-	-	-	-	-
Paire rosaces ronde ø 50 trou de clé, chrome satiné	-	-	-	00966776	1	-	-	-	-	-	-	-	-
Paire rosaces ronde ø 50 à condamnation, chrome satiné	-	-	-	00966786	1	-	-	-	-	-	-	-	-

Non stocké/Non-stored/Producto no estocado - Sur stock Europe Zone 1 et Zone 2, nous consulter pour délai d'approvisionnement - Epuement/Stock depletion/Agotamiento del stock



Poignée sur rosace chromé poli/satin / ARION

PROTECT



GARANTIE

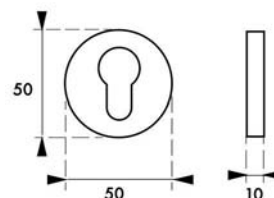
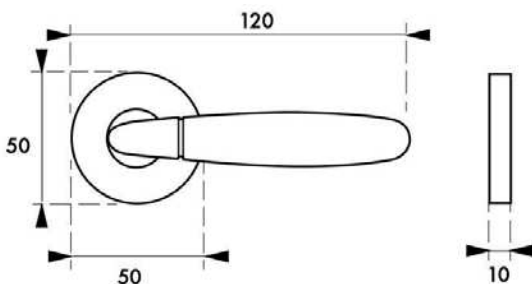

Description/Description/Descripción

Béquilles laiton. Vis de fixation invisibles. Carré acier 7mm. Ressort de rappel.

Brass handles. Invisible fixing screws. Steel square spindle 7mm. With spring.

Brazos de latón. Tornillos de fijación invisibles. Cuadrado de acero de 7mm. Con muelle.

Finition/Finsih/Acabado

Chromé poli/satin.

Chrome plated/satin.

Cromado pulido/satinado.

Designation	Boite	Colis.	Prix	Sachet	Colis.	Prix	Brochable					Colis.	Prix
							France	Euro 1	Euro 2	Euro 3	Euro 4		
Poignée sur rosace ARION chrome satiné/chrome poli	-	-	-	00966794	1	-	-	-	-	-	-	-	-
Paire rosaces ronde ø 50 trou de cylindre, finition chrome satiné	-	-	-	00966807	1	-	-	-	-	-	-	-	-
Paire rosaces ronde ø 50 trou de cle, finition chrome satiné	-	-	-	00966806	1	-	-	-	-	-	-	-	-
Paire rosaces ronde ø 50 à condamnation, finition chrome satiné	-	-	-	00966808	1	-	-	-	-	-	-	-	-

⚠ Non stocké/Non-stored/Producto no estocado - 📦 Sur stock Europe Zone 1 et Zone 2, nous consulter pour délai d'approvisionnement - 🇪🇺 Epuisement/Stock depletion/Agotamiento del stock

Béquille double argent, couleur F2, aspect inox / ARCHIMEDE RESIST



GARANTIE

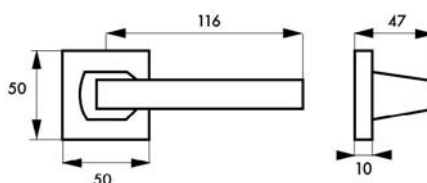

Description/Description/Descripción

Béquilles aluminium. Vis de fixation invisibles. Carré acier 7 mm.

Aluminium handles. Invisible fixing screws. Steel Square spindle 7 mm.

Brazos de aluminio. Tornillos de fijación invisibles. Cuadrado acero de 7 mm.

Finition/Finsih/Acabado

Argent F1 / couleur F2 / Aspect inox F9

Silver / color F2/ Stainless steel

Plata / color F2/ Aspecto inoxidable

Utilisation/Use/Utilización

Pour porte épaisseur 38-43mm

For 38-43mm door thickness

Para puerta de 38-43 mm

Designation	Boîte	Colis.	Prix	Sachet	Colis.	Prix	Brochable					Colis.	Prix
							France	Euro 1	Euro 2	Euro 3	Euro 4		
Béquille Double ARCHIMEDE Argent F1	00066680	10	-	-	-	-	-	-	-	-	-	-	-
Rosace Condamnation F1 (la paire)	00066689	10	-	-	-	-	-	-	-	-	-	-	-
Rosace Clé F1 (la paire)	00066683	10	-	-	-	-	-	-	-	-	-	-	-
Rosace Cylindre F1 (la paire)	00066686	10	-	-	-	-	-	-	-	-	-	-	-
Béquille Double ARCHIMEDE couleur F2	00066681	10	-	-	-	-	-	-	-	-	-	-	-
Rosace Condamnation couleur F2 (la paire)	00066690	10	-	-	-	-	-	-	-	-	-	-	-
Rosace Clé couleur F2 (la paire)	00066684	10	-	-	-	-	-	-	-	-	-	-	-
Rosace Cylindre couleur F2 (la paire)	00066687	10	-	-	-	-	-	-	-	-	-	-	-
Béquille Double ARCHIMEDE Aspect Inox F9	00066682	10	-	-	-	-	-	-	-	-	-	-	-
Rosace Condamnation F9 (la paire)	00066691	10	-	-	-	-	-	-	-	-	-	-	-
Rosace Clé F9 (la paire)	00066685	10	-	-	-	-	-	-	-	-	-	-	-
Rosace Cylindre F9 (la paire)	00066688	10	-	-	-	-	-	-	-	-	-	-	-

Non stocké/Non-stored/Producto no estocado - Sur stock Europe Zone 1 et Zone 2, nous consulter pour délai d'approvisionnement - Epuement/Stock depletion/Agotamiento del stock



Béquille double argent, chromé poli, noir / GRAN PRIX

RESIST



GARANTIE

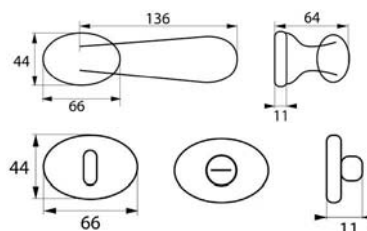

Description/Description/Descripción

Béquilles aluminium. Vis de fixation invisibles. Carré acier 7 mm. Ressort de rappel.

Aluminium handles. Invisible fixing screws. Steel Square spindle 7 mm. With spring.

Brazos de aluminio. Tornillos de fijación invisibles. Cuadrado acero de 7 mm. Com muelle.

Finition/Finsih/Acabado

Argent / Chromé poli / Alu noir mat

Silver / Chrome plated / black matt

Plata / Cromado pulido / negro mate

Utilisation/Use/Utilización

Pour porte épaisseur 38-43mm

For 38-43mm door thickness

Para puerta de 38-43 mm

Designation	Boite	Colis.	Prix	Sachet	Colis.	Prix	Brochable					Colis.	Prix
							France	Euro 1	Euro 2	Euro 3	Euro 4		
Béquille double GRAN PRIX argent	00066600	10	-	-	-	-	-	-	-	-	-	-	-
Rosace Condamnation (la paire)	00066603	10	-	-	-	-	-	-	-	-	-	-	-
Rosace Clé (la paire)	00066601	10	-	-	-	-	-	-	-	-	-	-	-
Rosace Cylindre (la paire)	00066602	10	-	-	-	-	-	-	-	-	-	-	-
Béquille Double GRAN PRIX chromé poli	00066604	10	-	-	-	-	-	-	-	-	-	-	-
Rosace Condamnation (la paire)	00066607	10	-	-	-	-	-	-	-	-	-	-	-
Rosace Clé (la paire)X	00066605	10	-	-	-	-	-	-	-	-	-	-	-
Rosace Cylindre (la paire)	00066606	10	-	-	-	-	-	-	-	-	-	-	-
Béquille Double GRAN PRIX Alu Noir Mat	00066608	10	-	-	-	-	-	-	-	-	-	-	-
Rosace Condamnation (la paire)	00066611	10	-	-	-	-	-	-	-	-	-	-	-
Rosace Clé (la paire)	00066609	10	-	-	-	-	-	-	-	-	-	-	-
Rosace Cylindre (la paire)	00066610	10	-	-	-	-	-	-	-	-	-	-	-

⚠ Non stocké/Non-stored/Producto no estocado - 📦 Sur stock Europe Zone 1 et Zone 2, nous consulter pour délai d'approvisionnement - 📦 Epuisement/Stock depletion/Agotamiento del stock

Béquille double argent, chromé poli, noir / LEONARDO

RESIST



by



GARANTIE

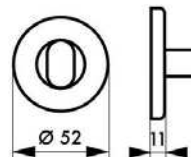
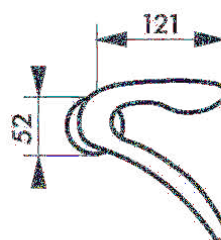

Description/Description/Descripción

Béquilles aluminium. Vis de fixation invisibles. Carré acier 7 mm. Ressort de rappel.

Aluminium handles. Invisible fixing screws. Steel Square spindle 7 mm. With spring.

Brazos de aluminio. Tornillos de fijación invisibles. Cuadrado acero de 7 mm. Com muelle.

Finition/Finsih/Acabado

Argent / Chromé poli / Alu noir mat

Silver / Chrome plated / black matt

Plata / Cromado pulido / negro mate

Utilisation/Use/Utilización

Pour porte épaisseur 38-43mm

For 38-43mm door thickness

Para puerta de 38-43 mm

Designation	Boîte	Colis.	Prix	Sachet	Colis.	Prix	Brochable					Colis.	Prix
							France	Euro 1	Euro 2	Euro 3	Euro 4		
Béquille Double LEONARDO argent	00066620	10	-	-	-	-	-	-	-	-	-	-	-
Rosace à condamnation et décondamnation	00066623	10	-	-	-	-	-	-	-	-	-	-	-
Paire de rosaces trou de clé	00066621	10	-	-	-	-	-	-	-	-	-	-	-
Paire de rosaces trou de cylindre	00066622	10	-	-	-	-	-	-	-	-	-	-	-
Béquille Double LEONARDO Chromé poli	00066624	10	-	-	-	-	-	-	-	-	-	-	-
Rosace Condamnation (la paire)	00066627	10	-	-	-	-	-	-	-	-	-	-	-
Rosace Clé (la paire)	00066625	10	-	-	-	-	-	-	-	-	-	-	-
Rosace Cylindre (la paire)	00066626	10	-	-	-	-	-	-	-	-	-	-	-
Béquille Double LEONARDO Alu Noir Mat	00066628	10	-	-	-	-	-	-	-	-	-	-	-
Rosace Condamnation (la paire)	00066631	10	-	-	-	-	-	-	-	-	-	-	-
Rosace Clé (la paire)	00066629	10	-	-	-	-	-	-	-	-	-	-	-
Rosace Cylindre (la paire)	00066630	10	-	-	-	-	-	-	-	-	-	-	-

Non stocké/Non-stored/Producto no estocado - Sur stock Europe Zone 1 et Zone 2, nous consulter pour délai d'approvisionnement - Epuisement/Stock depletion/Agotamiento del stock



Béquille double chromé poli, nickelé satiné / FIFTY

RESIST



by



GARANTIE

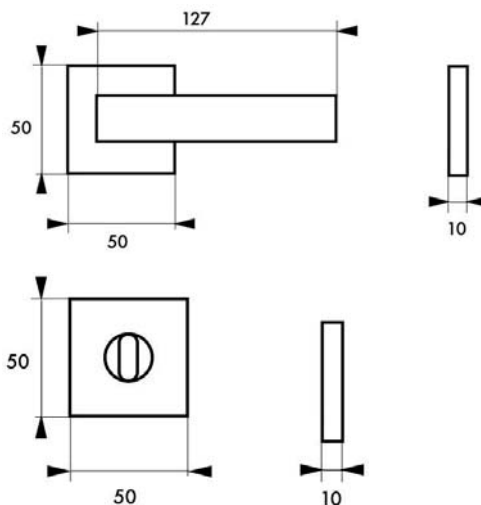

Description/Description/Descripción

Béquilles alliage. Vis de fixation invisibles. Carré acier 7 mm. Ressort de rappel.

Alloy handles. Invisible fixing screws. Steel spindle 7 mm. With spring.

Brazos de aleación. Tornillos de fijación invisibles. Cuadrado acero de 7 mm. Com muelle.

Finition/Finish/Acabado

Chromé poli / Nickelé satiné

Chrome plated / Satin nickel

Cromado pulido / nickel satinado

Utilisation/Use/Utilización

Pour porte épaisseur 38-43mm

For 38-43mm door thickness

Para puerta de 38-43 mm

Designation	Boite	Colis.	Prix	Sachet	Colis.	Prix	Brochable					Colis.	Prix
							France	Euro 1	Euro 2	Euro 3	Euro 4		
Béquille Double FIFTY Chromé poli	00066660	10	-	-	-	-	-	-	-	-	-	-	-
Rosace Condamnation (la paire)	00066663	10	-	-	-	-	-	-	-	-	-	-	-
Rosace Clé (la paire)	00066661	10	-	-	-	-	-	-	-	-	-	-	-
Rosace Cylindre (la paire)	00066662	10	-	-	-	-	-	-	-	-	-	-	-
Béquille Double FIFTY Nickelé satiné	00066670	10	-	-	-	-	-	-	-	-	-	-	-
Rosace Condamnation (la paire)	00066673	10	-	-	-	-	-	-	-	-	-	-	-
Rosace Clé (la paire)	00066671	10	-	-	-	-	-	-	-	-	-	-	-
Rosace Cylindre (la paire)	00066672	10	-	-	-	-	-	-	-	-	-	-	-

⚠ Non stocké/Non-stored/Producto no estocado - 📦 Sur stock Europe Zone 1 et Zone 2, nous consulter pour délai d'approvisionnement - 📦 Epuisement/Stock depletion/Agotamiento del stock

Béquille double chromé poli, nickelé brossé / SHARK

RESIST



by



GARANTIE

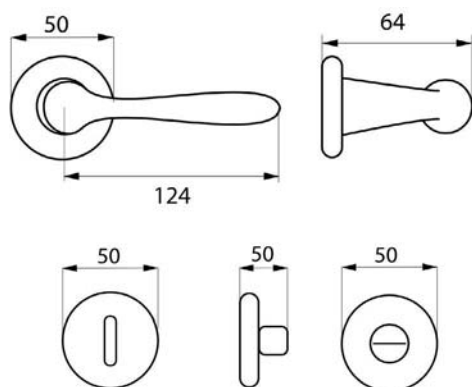

Description/Description/Descripción

Béquilles alliage. Vis de fixation invisibles. Carré acier 7 mm. Ressort de rappel.

Alloy handles. Invisible fixing screws. Steel Square spindle 7 mm. With spring.

Brazos de aleación. Tornillos de fijación invisibles. Cuadrado acero de 7 mm. Com muelle.

Finition/Finish/Acabado

Chromé poli / Nickelé brossé

Chrome plated / Nickel brushed

Cromado pulipulido / Niquel cepillado

Utilisation/Use/Utilización

Pour porte épaisseur 38-43mm

For 38-43mm door thickness

Para puerta de 38-43 mm

Designation	Boîte	Colis.	Prix	Sachet	Colis.	Prix	Brochable					Colis.	Prix
							France	Euro 1	Euro 2	Euro 3	Euro 4		
Béquille Double SHARK Chromé poli	00066700	10	-	-	-	-	-	-	-	-	-	-	-
Rosace Condamnation (la paire)	00066703	10	-	-	-	-	-	-	-	-	-	-	-
Rosace Clé (la paire)	00066701	10	-	-	-	-	-	-	-	-	-	-	-
Rosace Cylindre (la paire)	00066702	10	-	-	-	-	-	-	-	-	-	-	-
Béquille Double SHARK nickelé brossé	00066710	10	-	-	-	-	-	-	-	-	-	-	-
Rosace Condamnation (la paire)	00066713	10	-	-	-	-	-	-	-	-	-	-	-
Rosace Clé (la paire)	00066711	10	-	-	-	-	-	-	-	-	-	-	-
Rosace Cylindre (la paire)	00066712	10	-	-	-	-	-	-	-	-	-	-	-

Non stocké/Non-stored/Producto no estocado - Sur stock Europe Zone 1 et Zone 2, nous consulter pour délai d'approvisionnement - Epuisement/Stock depletion/Agotamiento del stock





GARANTIE



00000476

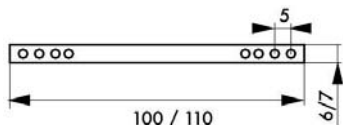

00110491

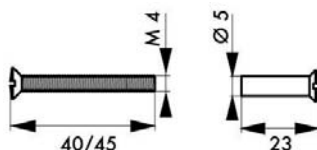

00006700



00007800



Description/Description/Descripción

CARRE : Tige acier zingué Carré 6 ou 7 mm
 FOURREAU : Fourreau acier cambré
 VIS : Vis métaux tête fraisée bombée fendue M4

SPINDLE : Zinc plated steel spindle 6 or 7 mm
 SPINDLE SLEEVE : Steel spindle sleeve
 SCREWS : Convex headed screws M4

CUADRADO: Vástago de acero cincado cuadrado de 6 ó 7 mm.
 FUNDA: Funda de acero curvado
 TORNILLOS: Tornillos de metal con cabeza fresada bombada ranurado M4

Finition/Finsih/Acabado

0
 0
 0

Version/Option/Versión

FOURREAU : 7 à 8 mm pour tige de 7 mm - 6 à 7 mm pour tige de 6 mm
 VIS : longueur 40 mm pour ensemble chromé et nylon - longueur 45 mm avec douille pour ensemble aluminium - longueur 45 mm avec douille pour ensemble laiton

SPINDLE SLEEVE : 7 to 8 mm for square rod 7 mm - 6 to 7 mm for square rod 6 mm
 SCREWS : Length 40 mm for chrome plated and nylon handle set - Length 45 mm with spindle for aluminium handle set - Length 45 mm with spindle for brass handle set

FUNDA: de 7 a 8 mm para un vástago de 7 mm - de 6 a 7 mm para un vástago de 6 mm.
 TORNILLOS: 40 mm de longitud para conjunto cromado y nylon - 45 mm de longitud con casquillo para conjunto de aluminio - 45 mm de longitud con casquillo para conjunto de latón.



00011476



Designation	Boite	Colis.	Prix	Sachet	Colis.	Prix	Brochable					Colis.	Prix
							France	Euro 1	Euro 2	Euro 3	Euro 4		
FOURREAU CARRE 6 à 7 mm (2 pièces sur carte)	00006700	10	-	-	-	-	00106700	-	-	-	-	10	-
FOURREAU CARRE 7 à 8 mm (2 pièces sur carte)	00007800	10	-	-	-	-	00107800	-	-	-	-	10	-
CARRE percé 6 x 100 mm (2 pièces sur carte)	00000477	10	-	-	-	-	00100477	-	-	-	-	10	-
CARRE percé 6 x 110 mm (2 pièces sur carte)	00010477	10	-	-	-	-	00110477	-	-	-	-	10	-

Accessoires / CARRE - FOURREAU - VIS



00110492



00110493



00110495

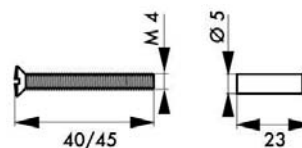
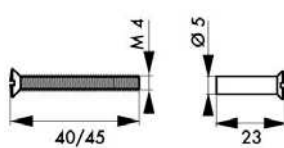
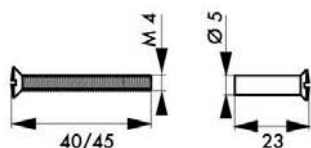

Designation	Boîte	Colis.	Prix	Sachet	Colis.	Prix	Brochable					Colis.	Prix
							France	Euro 1	Euro 2	Euro 3	Euro 4		
CARRE percé 7 x 100 mm (2 pièces sur carte)	00000476	10	-	-	-	-	00100476	-	-	-	-	10	-
Jeu de 2 CARRE 6 x 110 mm fendus	-	-	-	-	-	-	00110483	-	-	-	-	10	-
Jeu de 2 CARRE 7 x 110 mm fendus	-	-	-	-	-	-	00110484	-	-	-	-	10	-
Jeu de 2 CARRE 6 x 110 mm pleins	-	-	-	-	-	-	00110481	-	-	-	-	10	-
Jeu de 2 CARRE 7 x 110 mm pleins	-	-	-	-	-	-	00110482	-	-	-	-	10	-
CARRÉ borgne 7 x 100mm	00011476	10	-	-	-	-	00111476	-	-	-	-	10	-
VIS métaux 4 x 40 mm pour ensemble chromé et nylon (2 pièces sur carte)	00000445	10	-	-	-	-	00100445	-	-	-	-	10	-
VIS métaux 4 x 45 mm pour ensemble alu avec douille (2 pièces sur carte)	00000447	10	-	-	-	-	00100447	-	-	-	-	10	-
VIS métaux 4 x 45 mm pour ensemble laiton avec douille (2 pièces sur carte)	00000448	10	-	-	-	-	00100448	-	-	-	-	10	-
Jeu de 2 vis M5 x 40 zingué	-	-	-	-	-	-	00110496	-	-	-	-	10	-
Jeu de 2 vis sécables avec douilles M4 x 50 laitonné	-	-	-	-	-	-	00110491	-	-	-	-	10	-
Jeu de 2 vis sécables avec douilles M4 x 50 nickelé	-	-	-	-	-	-	00110492	-	-	-	-	10	-
Jeu de 2 vis sécables avec douilles M4 x 50 noires	-	-	-	-	-	-	00110493	-	-	-	-	10	-
Jeu de 2 vis sécables avec douilles M4 x 50 fer patiné	-	-	-	-	-	-	00110494	-	-	-	-	10	-
Jeu de 2 vis sécables avec douilles M4 x 50 vieux laiton	-	-	-	-	-	-	00110495	-	-	-	-	10	-
Jeu de 6 vis pointeau et clé	-	-	-	-	-	-	00110490	-	-	-	-	10	-



00110490



00110496

Poignée de porte battante / INOX RESIST

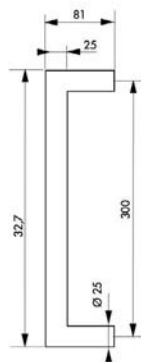

GARANTIE

Description/Description/Descripción

Poignée de tirage en INOX 304, secteur carré 25x25mm, Entraxe de fixation 300mm. Fourni avec kit de fixation : Pour montage double face sur porte Bois, Acier, Alu, PVC (pour porte épaisseur 30 à 70mm) Pour montage simple Non Traversant sur porte Bois Pour montage non Traversant sur porte Métal, Alu, PVC sur écrou aveugle M8 (non fourni).

Stainless Steel 304 pull Handle, fixing square 25x25mm, backset 300mm. With screws. Fixing kit provided: For wooden, steel, aluminium and PVC Door (thickness from 30 to 70 mm) For Simple Assembly only. Not crossing. For Assembly with blind rivet nut on Metallic, Aluminium or PVC doors (unprovided)

Manilla en ACERO INOXIDABLE 304, cuadrado de 25x25mm, Distancia de fijación 300mm. Se suministra con el kit de fijación: Para el montaje de doble cara en puertas de madera, acero, aluminio, PVC (para puertas de 30 a 70 mm de grosor). Para montaje simple No pasante en puerta de madera Para el montaje de la puerta no pasante Metal, Aluminio, PVC sobre tuerca ciega M8 (no suministrada).

Finition/Finsih/Acabado

Inox satiné
Satin Stainless Steel
Inox satinado

Designation	Boite	Colis.	Prix	Sachet	Colis.	Prix	Brochable					Colis.	Prix
							France	Euro 1	Euro 2	Euro 3	Euro 4		
Paire de poignées tirage inox 25x25 de porte battante - EA 300mm	00067510	1	-	-	-	-	-	-	-	-	-	-	-

Poignée de porte battante / INOX RESIST

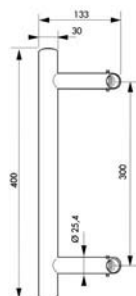

GARANTIE

Description/Description/Descripción

Poignée de tirage en INOX 304, Diamètre 30mm, Entraxe de fixation 300mm, support en biais 45°. Fourni avec kit de fixation : Pour montage double face sur porte Bois, Acier, Alu, PVC (pour porte épaisseur 30 à 70mm) Pour montage simple Non Traversant sur porte Bois Pour montage non Traversant sur porte Métal, Alu, PVC sur écrou aveugle M8 (non fourni)

Stainless Steel 304 pull Handle, Diam.30 mm, backset 300mm. 45° angled support. Fixing kit provided: For wooden, steel, aluminium and PVC Door (thickness from 30 to 70 mm) For Simple Assembly only. Not crossing. For Assembly with blind rivet nut on Metallic, Aluminium or PVC doors (unprovided)

Manilla en ACERO INOXIDABLE 304, Diámetro 30mm, Distancia de fijación 300mm, soporte en ángulo de 45°. Se suministra con el kit de fijación Para el montaje de doble cara en puertas de madera, acero, aluminio o PVC (para puertas de 30 a 70 mm de grosor) Para montaje simple No pasante en puerta de madera Para el montaje No pasante para puerta de Metal, Aluminio, PVC sobre tuerca ciega M8 (no suministrada).

Finition/Finsih/Acabado

Inox satiné
Satin Stainless Steel
Inox satinado

Designation	Boite	Colis.	Prix	Sachet	Colis.	Prix	Brochable					Colis.	Prix
							France	Euro 1	Euro 2	Euro 3	Euro 4		
Paire de poignées tirage inox D 30 de porte battante - HT 400mm	00067511	1	-	-	-	-	-	-	-	-	-	-	

⚠ Non stocké/Non-stored/Producto no estocado - 📦 Sur stock Europe Zone 1 et Zone 2, nous consulter pour délai d'approvisionnement - 📦 Epuisement/Stock depletion/Agotamiento del stock

Poignée de porte battante / INOX RESIST

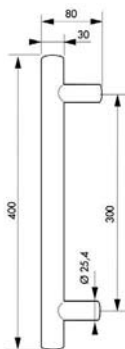

GARANTIE

Description/Description/Descripción

Poignée de tirage en INOX 304, Diamètre 30mm, Entraxe de fixation 300mm, support droit. Fourni avec kit de fixation : Pour montage double face sur porte Bois, Acier, Alu, PVC (pour porte épaisseur 30 à 70mm) Pour montage simple Non Traversant sur porte Bois Pour montage non Traversant sur porte Métal, Alu, PVC sur écrou aveugle M8 (non fourni)

Stainless Steel 304 pull Handle, Diam.30 mm, backset 300mm. Straight support. Fixing kit provided: For wooden, steel, aluminium and PVC Door (thickness from 30 to 70 mm) For Simple Assembly only. Not crossing. For Assembly with blind rivet nut on Metallic, Aluminium or PVC doors (unprovided)

Manilla en ACERO INOXIDABLE 304, Diámetro 30mm, Distancia de fijación 300mm, soporte a derechas. Se suministra con el kit de fijación Para el montaje de doble cara en puertas de madera, acero, aluminio o PVC (para puertas de 30 a 70 mm de grosor) Para montaje simple No pasante en puerta de madera Para el montaje No pasante para puerta de Metal, Aluminio, PVC sobre tuerca ciega M8 (no suministrada).

Finition/Finsih/Acabado

Inox satiné
Satin Stainless Steel
Inox satindo

Designation	Boite	Colis.	Prix	Sachet	Colis.	Prix	Brochable					Colis.	Prix
							France	Euro 1	Euro 2	Euro 3	Euro 4		
Paire de poignées tirage inox D 30 de porte battante - HT 400mm	00067512	1	-	-	-	-	-	-	-	-	-	-	-

Poignée de porte battante / INOX RESIST

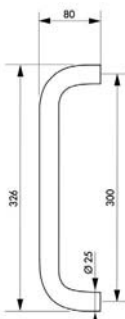

GARANTIE

Description/Description/Descripción

Poignée de tirage en INOX 304, Diamètre 25mm, Entraxe de fixation 300mm. Fourni avec kit de fixation Pour montage double face sur porte Bois, Acier, Alu, PVC (pour porte épaisseur 30 à 70mm) Pour montage simple Non Traversant sur porte Bois Pour montage non Traversant sur porte Métal, Alu, PVC sur écrou aveugle M8 (non fourni).

Stainless Steel 304 pull Handle, Diam.25 mm, backset 300mm. Straight support. Fixing kit provided: For wooden, steel, aluminium and PVC Door (thickness from 30 to 70 mm) For Simple Assembly only. Not crossing. For Assembly with blind rivet nut on Metallic, Aluminium or PVC doors (unprovided).

Manilla en ACERO INOXIDABLE 304, Diámetro 25mm, Distancia de fijación 300mm. Se suministra con el kit de fijación Para el montaje de doble cara en puertas de madera, acero, aluminio o PVC (para puertas de 30 a 70 mm de grosor) Para montaje simple No pasante en puerta de madera Para el montaje No pasante para puerta de Metal, Aluminio, PVC sobre tuerca ciega M8 (no suministrada).

Finition/Finsih/Acabado

Inox satiné
Satin Stainless Steel
Inox satindo

Designation	Boite	Colis.	Prix	Sachet	Colis.	Prix	Brochable					Colis.	Prix
							France	Euro 1	Euro 2	Euro 3	Euro 4		
Paire de poignées tirage inox D 25 de porte battante - EA 300mm	00067513	1	-	-	-	-	-	-	-	-	-	-	

⊗ Non stocké/Non-stored/Producto no estocado - ⊕ Sur stock Europe Zone 1 et Zone 2, nous consulter pour délai d'approvisionnement - ⊖ Epuisement/Stock depletion/Agotamiento del stock



Poignée de porte battante / INOX RESIST



GARANTIE

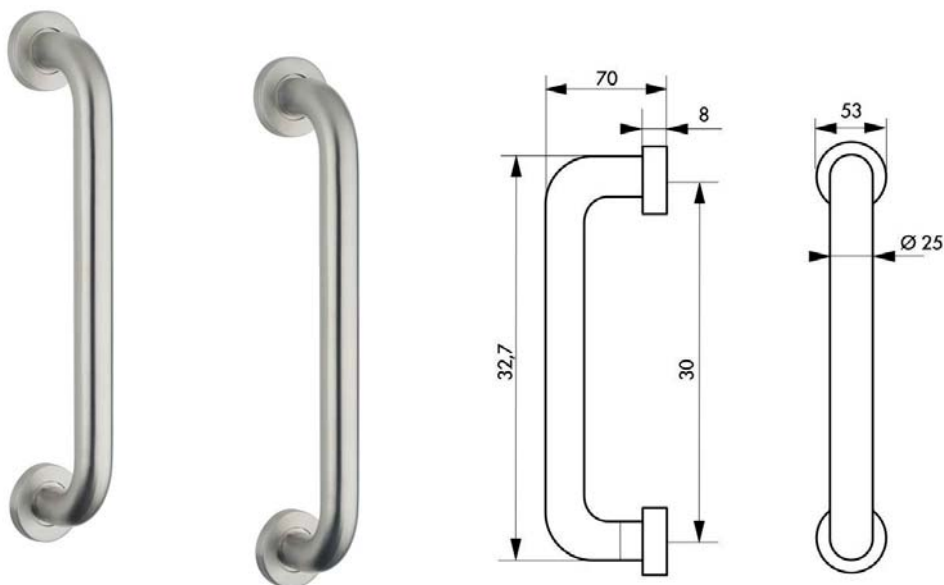

Description/Description/Descripción

Poignée de tirage en INOX 304 sur rosace D53mm, Tube Diamètre 25mm * longueur 325mm. Fourni avec 6 vis de fixation pour porte bois.

Stainless Steel 304 pull Handle with rosace diam.53mm, Tubes diam.25mm, length 325mm. Provided with 6 fixing screws for wooden doors..

Manija en ACERO INOXIDABLE 304 sobre roseta D53mm, Diámetro del tubo 25mm * longitud 325mm. Se suministra con 6 tornillos de fijación para la puerta de madera.

Finition/Finsih/Acabado

Inox satiné
Satin Stainless Steel
Inox satindo

Designation	Boite	Colis.	Prix	Sachet	Colis.	Prix	Brochable					Colis.	Prix
							France	Euro 1	Euro 2	Euro 3	Euro 4		
Paire de poignées tirage inox D 25 de porte battante - L 325mm	00067514	1	-	-	-	-	-	-	-	-	-	-	-

⚠ Non stocké/Non-stored/Producto no estocado - 📦 Sur stock Europe Zone 1 et Zone 2, nous consulter pour délai d'approvisionnement - 📦 Epuisement/Stock depletion/Agotamiento del stock

Poignée de porte battante / AVEC PLAQUE INOX

RESIST



GARANTIE



00067515



00067516



00067517

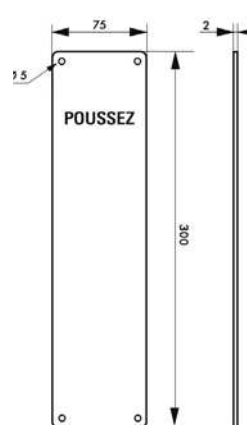
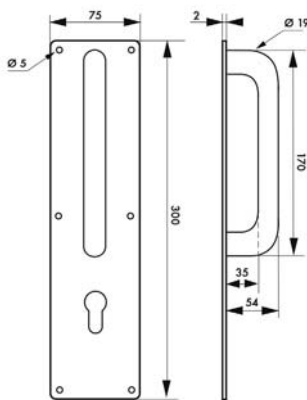
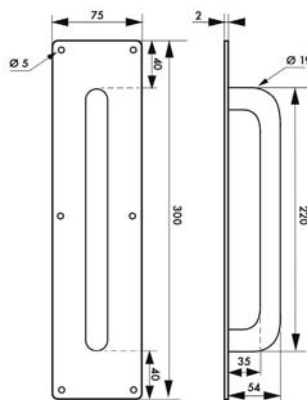

Description/Description/Descripción

067515 : Poignée de Tirage INOX 304, sur plaque 300x75mm ép 2mm, Poignée D.19 x L.220mm Fourni avec 6 vis de fixation sur porte bois. 067516 : Poignée de Tirage INOX 304, sur plaque 300x75mm ép 2mm, Poignée D.19 x L.220mm pour Cylindre PE. Fourni avec 6 vis de fixation sur porte bois. 067517 : Plaque de poussée en Inox 300 x 75 x 2mm, avec marquage noir «POUSSEZ». Fourni avec 6 vis de fixation sur porte bois.r.

067515 : *Stainless Steel 304 pull Handle on plate 300x75mm thickness 2mm. Handle D.19xL220mm Provided with 6 fixing screws for wooden doors.* 067516 : *Stainless Steel 304 pull Handle on plate 300x75mm thickness 2mm. Handle D.19xL220mm for Europrofil Cylinder. Provided with 6 fixing screws for wooden doors.* 067517 : *Stainless Steel plate 300x75x2mm, with black*

marking «POUSSEZ». Provided with 6 fixing screws for wooden doors.

067515 : Manilla de acero inoxidable 304, sobre placa de 300x75mm de 2mm, Manilla de D.19 x L.220mm. Se suministra con 6 tornillos para fijar a la puerta de madera. 067516 : Manilla de acero inoxidable 304, sobre placa de 300x75mm de 2mm, Manilla de D.19 x L.220mm. Para cilindro de perfil europeo Se suministra con 6 tornillos para fijar a la puerta de madera. 067517 : Placa de empuje en acero inoxidable 300 x 75 x 2mm, con la marca negra « POUSSEZ ». Se suministra con 6 tornillos para fijar a la puerta de madera.

Finition/Finsih/Acabado

Inox satiné
Satin Stainless Steel
Inox satindo

Designation	Boite	Colis.	Prix	Sachet	Colis.	Prix	Brochable					Colis.	Prix
							France	Euro 1	Euro 2	Euro 3	Euro 4		
Poignée tirage inox avec plaque 300x75 mm	00067515	1	-	-	-	-	-	-	-	-	-	-	-
Poignée tirage inox avec plaque 300x75 mm - pour cylindre profilé	00067516	1	-	-	-	-	-	-	-	-	-	-	-
Plaque propreté inox 300x75 mm marquage noir	00067517	1	-	-	-	-	-	-	-	-	-	-	-

Non stocké/Non-stored/Producto no estocado - Sur stock Europe Zone 1 et Zone 2, nous consulter pour délai d'approvisionnement - Epuisement/Stock depletion/Agotamiento del stock



Barre de maintien / INOX PROTECT

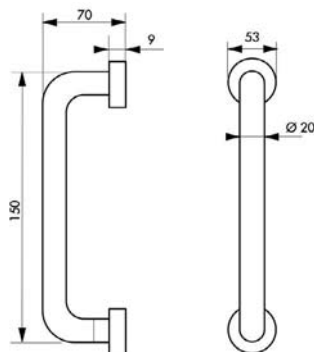

GARANTIE

Description/Barre de maintien en inox 304. Diamètre 19mm. Fourni avec vis de fixation.

Stainless Steel 304 handle. 19mm diameter. With screws. Fixing screws provided.

Barandilla de acero inoxidable 304. Dimetro 19mm. Se suministra con tornillos de fijación.

Finition/Inox brossé

Brushed stainless steel

Acero inoxidable cepillado

Designation	Boite	Colis.	Prix	Sachet	Colis.	Prix	Brochable					Colis.	Prix
							France	Euro 1	Euro 2	Euro 3	Euro 4		
Barre de maintien ø19mm L.150mm - inox brossé	00068660	1	-	-	-	-	-	-	-	-	-	-	-
Barre de maintien ø19mm L.200mm - inox brossé	00068661	1	-	-	-	-	-	-	-	-	-	-	-
Barre de maintien ø19mm L.300mm - inox brossé	00068662	1	-	-	-	-	-	-	-	-	-	-	-

Barre de maintien / INOX PROTECT

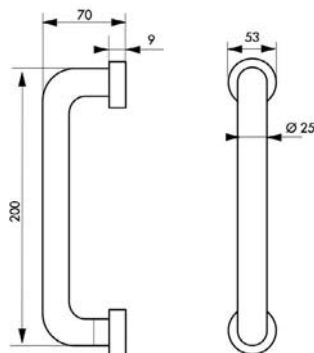

GARANTIE

Description/Description/Descripción

Barre de maintien en inox 304. Diamètre 25mm. Fourni avec vis de fixation.

Stainless Steel 304 handle. 25mm diameter. With screws. Fixing screws provided.

Barandilla de acero inoxidable 304. Dimetro 25mm. Se suministra con tornillos de fijación.

Finition/Finsih/Acabado

Inox brossé

Brushed stainless steel

Acero inoxidable cepillado

Designation	Boite	Colis.	Prix	Sachet	Colis.	Prix	Brochable					Colis.	Prix
							France	Euro 1	Euro 2	Euro 3	Euro 4		
Barre de maintien ø25mm L.200mm - inox brossé	00068663	1	-	-	-	-	-	-	-	-	-	-	-
Barre de maintien ø25mm L.300mm - inox brossé	00068664	1	-	-	-	-	-	-	-	-	-	-	-

⚠ Non stocké/Non-stored/Producto no estocado - 📦 Sur stock Europe Zone 1 et Zone 2, nous consulter pour délai d'approvisionnement - 📦 Epuisement/Stock depletion/Agotamiento del stock

Barre de maintien / INOX PROTECT

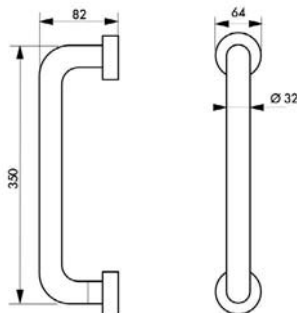

GARANTIE

Description/Description/Descripción

Barre de maintien en inox 304. Diamètre 32mm. Fourni avec vis de fixation.

Stainless Steel 304 handle. 32mm diameter. With screws. Fixing screws provided.

Barandilla de acero inoxidable 304. Dimetro 32mm. Se suministra con tornillos de fijación.

Finition/Finsih/Acabado

Inox poli, inox brossé

Polished stainless steel, brushed stainless steel

Acero inoxidable pulido, acero inoxidable cepillado

Designation	Boite	Colis.	Prix	Sachet	Colis.	Prix	Brochable					Colis.	Prix
							France	Euro 1	Euro 2	Euro 3	Euro 4		
Barre de maintien ø32mm L.350mm - inox brossé	00068665	1	-	-	-	-	-	-	-	-	-	-	-
Barre de maintien ø32mm L.550mm - inox brossé	00068666	1	-	-	-	-	-	-	-	-	-	-	-
Barre de maintien ø32mm L.350mm - inox poli	00068667	1	-	-	-	-	-	-	-	-	-	-	-
Barre de maintien ø32mm L.550mm - inox poli	00068668	1	-	-	-	-	-	-	-	-	-	-	-

Barre de maintien / INOX PROTECT

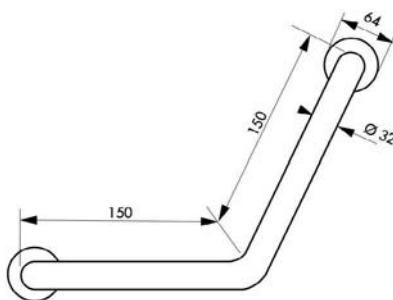

GARANTIE

Description/Description/Descripción

Barre de maintien en inox 304. Angle 135°. Diamètre 32mm. Fourni avec vis de fixation.

Stainless Steel 304 handle. Angle 135°. 32mm diameter. With screws. Fixing screws provided.

Barandilla de acero inoxidable 304. Angulo 135°. Ditro 32mm. Se suministra con tornillos de fijación.

Finition/Finsih/Acabado

Inox poli, inox brossé

Polished stainless steel, brushed stainless steel

Acero inoxidable pulido, acero inoxidable cepillado

Designation	Boite	Colis.	Prix	Sachet	Colis.	Prix	Brochable					Colis.	Prix
							France	Euro 1	Euro 2	Euro 3	Euro 4		
Barre de maintien angle 135° ø32mm L.350mm - inox poli	00068669	1	-	-	-	-	-	-	-	-	-	-	-
Barre de maintien angle 135° ø32mm L.350mm - inox brossé	00068670	1	-	-	-	-	-	-	-	-	-	-	-

Non stocké/Non-stored/Producto no estocado - Sur stock Europe Zone 1 et Zone 2, nous consulter pour délai d'approvisionnement - Epuisement/Stock depletion/Agotamiento del stock



Barre de maintien / INOX PROTECT

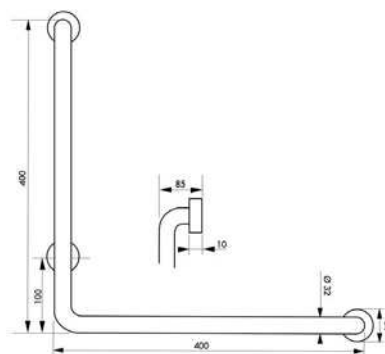

GARANTIE

Description/Description/Descripción

Barre de maintien en inox 304. Angle 90°. Diamètre 32mm. Fourni avec vis de fixation.
Stainless Steel 304 handle. Angle 90°. 32mm diameter. With screws. Fixing screws provided.
Barandilla de acero inoxidable 304. Angulo 90°. Dito 32mm. Se suministra con tornillos de fijación.

Finition/Finsih/Acabado

Inox poli, inox brossé
Polished stainless steel, brushed stainless steel
Acero inoxidable pulido, acero inoxidable cepillado

Designation	Boite	Colis.	Prix	Sachet	Colis.	Prix	Brochable					Colis.	Prix
							France	Euro 1	Euro 2	Euro 3	Euro 4		
Barre de maintien angle 90° ø32mm L.350mm - inox poli	00068671	1	-	-	-	-	-	-	-	-	-	-	-
Barre de maintien angle 90° ø32mm L.350mm - inox brossé	00068672	1	-	-	-	-	-	-	-	-	-	-	-

Barre de maintien / INOX PROTECT

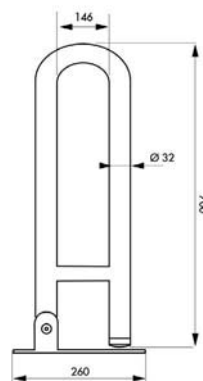

GARANTIE

Description/Description/Descripción

Barre de maintien en inox 304. Diamètre 32mm. Fourni avec vis de fixation.
Stainless Steel 304 handle. 32mm diameter. With screws. Fixing screws provided.
Barandilla de acero inoxidable 304. Dimetro 32mm. Se suministra con tornillos de fijación.

Finition/Finsih/Acabado

Inox poli
Polished stainless steel
Acero inoxidable pulido

Designation	Boite	Colis.	Prix	Sachet	Colis.	Prix	Brochable					Colis.	Prix
							France	Euro 1	Euro 2	Euro 3	Euro 4		
Barre de maintien rabattable ø32mm L.700mm - inox poli	00068673	1	-	-	-	-	-	-	-	-	-	-	-

Ⓜ Non stocké/Non-stored/Producto no estocado - Ⓜ Sur stock Europe Zone 1 et Zone 2, nous consulter pour délai d'approvisionnement - Ⓜ Epuisement/Stock depletion/Agotamiento del stock

Poignée de fenêtre / BOÎTIER - ACCESSOIRES - TRINGLES ECO

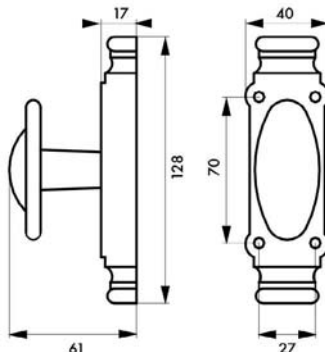

GARANTIE

Description/Description/Descripción

Boîtier et bouton fonte. Guide de tringle fonte. Gâches fonte. Tringle acier pour ouvrant 1,30 m.

Cast iron case and bolt. Cast iron rod guide. Cast iron strikers. Steel rod for 1,30 m opening.

Caja y botón de fundición. Guía de tranca de fundición.

Cerradores de fundición. Tranca de acero para practicable de 1,30 m.

Finition/Finsih/Acabado

Noir
Black
Negro

Designation	Boite	Colis.	Prix	Sachet	Colis.	Prix	Brochable					Colis.	Prix
							France	Euro 1	Euro 2	Euro 3	Euro 4		
BOITIER de crémons fonte en applique pour tringle apparente	00016021	10	-	00916021	10	-	00216021	-	-	-	-	10	-
ACCESSOIRES POUR CREMONE, guide + chapiteaux + gâches	00016022	10	-	-	-	-	00216022	-	-	-	-	10	-
TRINGLE 16x5 mm noire pour crémons 1,15 m	00016023	10	-	-	-	-	-	-	-	-	-	-	-
BOITIER de crémons fonte et accessoires	-	-	-	00916020	10	-	00216020	-	-	-	-	10	-

Poignée de fenêtre / BOUTON RUSTIQUE ECO

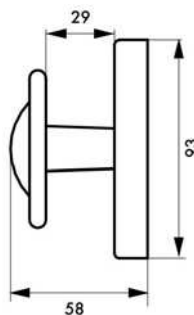

GARANTIE

Description/Description/Descripción

Bouton fonte. Platine fonte. Carré acier 7 mm. Vis de pose.

Cast iron knob. Cast iron plate. Steel Square 7 mm. Fixing screws.

Botón de fundición. Pletina de fundición. Cuadrado acero de 7 mm.

Finition/Finsih/Acabado

Noir
Black
Negro

Designation	Boite	Colis.	Prix	Sachet	Colis.	Prix	Brochable					Colis.	Prix
							France	Euro 1	Euro 2	Euro 3	Euro 4		
BOUTON fonte peinte avec vis de pose	00073680	10	-	-	-	-	00273680	-	-	-	-	10	-

Non stocké/Non-stored/Producto no estocado - Sur stock Europe Zone 1 et Zone 2, nous consulter pour délai d'approvisionnement - Epuement/Stock depletion/Agotamiento del stock



Poignée de fenêtre / BOUTON - BEQUILLE

ECO



GARANTIE



00990310

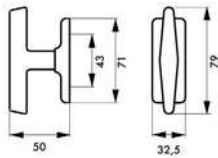

00990312

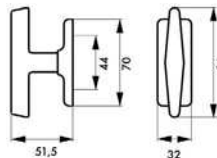

00990313

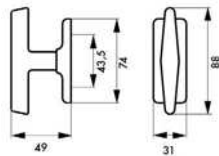

00990311

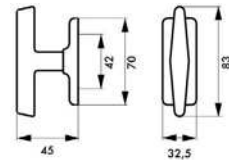

Description/Description/Descripción

Plaques acier embouti. Béquilles alliage fondu. Carré acier 7 mm. Vis métaux.

Steel plates. Cast alloy handles. Steel Square spindle 7 mm. Metal screws.

Placas de acero embutido. Brazos de aleación fundida. Cuadrado acero de 7 mm. Tornillos para metal.

Finition/Finsih/Acabado

Noir / blanc / laiton patiné / Nickelé satiné

Black / white / antique brass / satin nickel

Negro / blanco / latón antiguo / níquel satinado

Designation	Boîte	Colis.	Prix	Sachet	Colis.	Prix	Brochable					Colis.	Prix
							France	Euro 1	Euro 2	Euro 3	Euro 4		
Bouton de fenêtre COQ noir	-	-	-	00990310	6	-	00290310	-	-	-	-	10	-
Bouton de fenêtre ARTHÉMIS laiton	-	-	-	00990311	6	-	00290311	-	-	-	-	10	-
Bouton de fenêtre SELENE nick. satiné	-	-	-	00990312	6	-	00290312	-	-	-	-	10	-
Bouton de fenêtre HEBE blanc	-	-	-	00990313	6	-	00290313	-	-	-	-	10	-
Béquille entrebailleur de fenêtre LETO/MAÏA champ.	-	-	-	00990314	6	-	00290314	-	-	-	-	10	-
Bouton de fenêtre LETO/MAÏA champ.	-	-	-	00990315	6	-	00290315	-	-	-	-	10	-
Béquille de fenêtre LETO/MAÏA champ.	-	-	-	00990316	6	-	00290316	-	-	-	-	10	-

⚠ Non stocké/Non-stored/Producto no estocado - 📦 Sur stock Europe Zone 1 et Zone 2, nous consulter pour délai d'approvisionnement - 🇪🇺 Epuisement/Stock depletion/Agotamiento del stock

Poignée de fenêtre aluminium / BOUTON - BEQUILLE PROTECT



GARANTIE

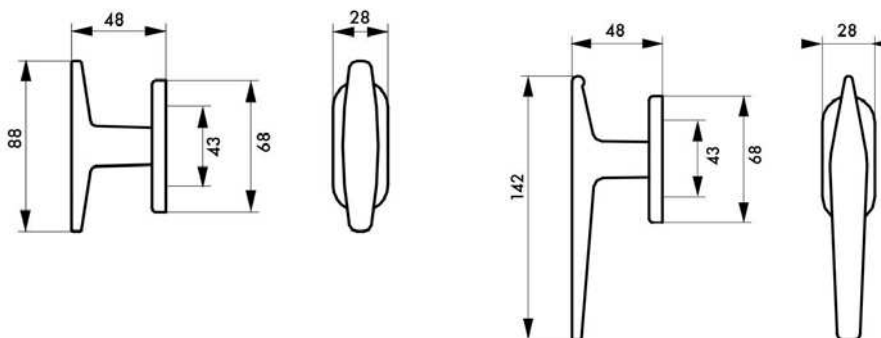

Description/Description/Descripción

Bouton aluminium fondu. Platine en aluminium embouti.
Carré acier 7 mm. Vis de pose.

Aluminium knob. Cast stamped aluminium plate. Steel
Square 7 mm. Fixing screws.

Botón de aluminio fundido. Pletina de aluminio embuti-
do. Cuadrado acero de 7 mm.

Finition/Finsih/Acabado

Anodisé F2

Anodized F2

Anodizado F2

Version/Option/Versión

Bouton entrebailleur

Half opening knob

Botón retenedor

Designation	Boite	Colis.	Prix	Sachet	Colis.	Prix	Brochable					Colis.	Prix
							France	Euro 1	Euro 2	Euro 3	Euro 4		
BOUTON FENÊTRE couleur F2 avec vis de pose	00000473	-	-	00900473	20	-	00200473	-	-	-	-	10	-
BOUTON ENTREBAILLEUR FENÊTRE couleur F2 avec vis de pose	00000474	1	-	-	-	-	00200474	-	-	-	-	10	-

Non stocké/Non-stored/Producto no estocado - Sur stock Europe Zone 1 et Zone 2, nous consulter pour délai d'approvisionnement - Epuement/Stock depletion/Agotamiento del stock



Poignée de fenêtre aluminium / BEQUILLE PROTECT



GARANTIE

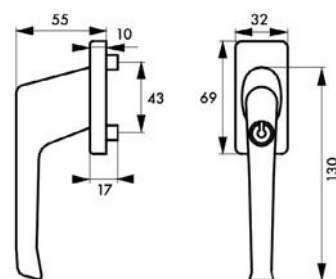
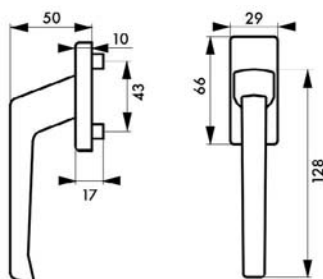

Description/Description/Descripción

Béquille aluminium avec crans 90°. Platine synthétique.
Vis de fixation invisibles. Carré acier 7 mm.

Aluminium handle with safety catch 90°. Synthetic plate.
Invisible fixing screws. Steel Square 7 mm.

Brazo de aluminio con muescas a 90°. Pletina sintética.
Tornillos de fijación invisibles. Cuadrado acero de 7 mm.

Finition/Finsih/Acabado

Laqué blanc. Anodisé couleur F2 ou argent.

Color F2 or silver anodized or white lacquered.

Anodizado color F2 o color plata o lacado blanco.

Version/Option/Versión

Avec cylindre de condamnation 1 clé

With locking disc tumblers 1 key

Con cilindro de condenación de plaquitas de 1 llave

Designation	Boite	Colis.	Prix	Sachet	Colis.	Prix	Brochable					Colis.	Prix
							France	Euro 1	Euro 2	Euro 3	Euro 4		
BEQUILLE FENÊTRE laqué blanc avec vis de pose	-	-	-	00900478	20	-	00200478	-	-	-	-	10	-
BEQUILLE FENÊTRE couleur F2 avec vis de pose	00000479	10	-	-	-	-	00200479	00293243 NS	00292243 NS	00294243	-	10	-
BEQUILLE FENÊTRE argent avec vis de pose	00000482	10	-	-	-	-	00200482	-	-	-	-	10	-
BEQUILLE FENÊTRE clé couleur F2 avec vis de pose	00000483	10	-	-	-	-	00200483	00293244 NS	00292244 NS	00294244	-	10	-
BEQUILLE FENÊTRE clé laqué blanc avec vis de pose	00002483	10	-	-	-	-	-	-	-	-	-	-	-

NS Non stocké/Non-stored/Producto no estocado - ☐ Sur stock Europe Zone 1 et Zone 2, nous consulter pour délai d'approvisionnement - ☒ Epuisement/Stock depletion/Agotamiento del stock

Poignée de fenêtre aluminium / BEQUILLE

PROTECT

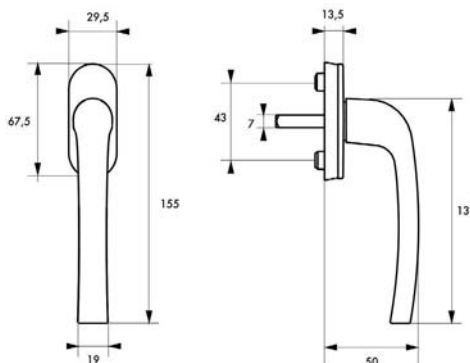

GARANTIE

Description/Description/Descripción

Béquille aluminium avec crans 90°. Platine synthétique.
 Vis de fixation invisibles. Carré acier 7 mm.
*Aluminium handle with safety catch 90°. Synthetic plate.
 Invisible fixing screws. Steel Square 7 mm.*
 Brazo de aluminio con muescas a 90°. Pletina sintética.
 Tornillos de fijación invisibles. Cuadrado acero de 7 mm.

Finition/Finsih/Acabado

Laqué blanc.
White lacquered.
 Lacado blanco.

Version/Option/Versión

Avec cylindre de condamnation 2 clés
With locking disc tumblers 2 keys
 Con cilindro de condenación de plaquitas de 2 llaves

Designation	Boite	Colis.	Prix	Sachet	Colis.	Prix	Brochable					Colis.	Prix
							France	Euro 1	Euro 2	Euro 3	Euro 4		
Béquille de fenêtre laqué blanc à clé	00002486	10	-	-	-	-	00202486	-	-	-	-	10	-
Béquille de fenêtre laqué blanc	00002485	10	-	-	-	-	00202485	-	-	-	-	10	-

Poignée de fenêtre / BOUTON

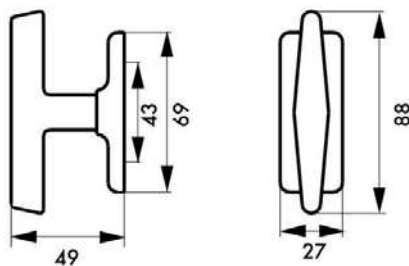

GARANTIE

Description/Description/Descripción

Bouton alliage. Platine alliage. Carré acier 7 mm . Vis de pose.
Alloy knob. Alloy plate. Steel Square 7 mm. Fixing screws.
 Botón de aleación. Pletina de aleación. Cuadrado acero de 7 mm. Tornillo de montaje.

Finition/Finsih/Acabado

Chromé
Chrome plated
 Cromado

Designation	Boite	Colis.	Prix	Sachet	Colis.	Prix	Brochable					Colis.	Prix
							France	Euro 1	Euro 2	Euro 3	Euro 4		
BOUTON POUR FENETRE chromé	-	-	-	00900475	20	-	00200475	-	-	-	-	10	-

Non stocké/Non-stored/Producto no estocado - Sur stock Europe Zone 1 et Zone 2, nous consulter pour délai d'approvisionnement - Epuement/Stock depletion/Agotamiento del stock



Poignée de fenêtre porcelaine / BOUTON PROTECT



GARANTIE

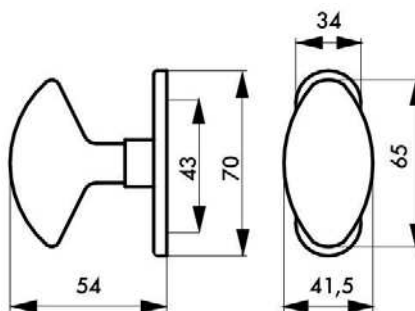

Description/Description/Descripción

Bouton ovale porcelaine. Monture laiton. Carré acier 7 mm. Vis de pose acier laitoné.

Porcelain oval knob. Brass plate. Steel Square 7 mm. Brass steel fixing screws.

Botón ovalado de porcelana. Montura de latón. Cuadrado acero de 7 mm. Tornillos de fijación de acero latonado.

Finition/Finsih/Acabado

Blanc

White

Blanco barnizado

Designation	Boite	Colis.	Prix	Sachet	Colis.	Prix	Brochable					Colis.	Prix
							France	Euro 1	Euro 2	Euro 3	Euro 4		
BOUTON PORCELAINE sur platine avec vis de pose	00001481	10	-	-	-	-	00201481	-	-	-	-	10	-

Poignée de fenêtre laiton / BOUTON RESIST



GARANTIE

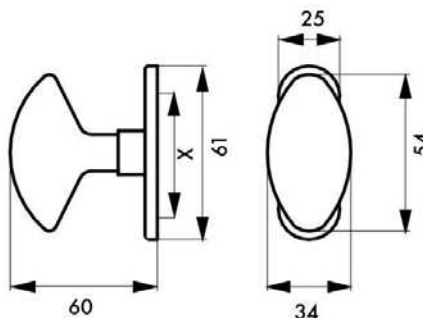

Description/Description/Descripción

Bouton ovale laiton massif. Platine laiton. Carré acier 7 mm. Vis de pose laiton.

Bouton ovale laiton massif. Platine laiton. Square acier 7 mm. Vis de pose laiton.

Botón ovalado de latón macizo. Pletina de latón. Cuadrado acero de 7 mm. Tornillos de latón.

Finition/Finsih/Acabado

Laiton poli

Polished brass

Latón pulido

Designation	Boite	Colis.	Prix	Sachet	Colis.	Prix	Brochable					Colis.	Prix
							France	Euro 1	Euro 2	Euro 3	Euro 4		
BOUTON laiton poli sur platine avec vis de pose	00001475	5	-	-	-	-	00201475	-	-	-	-	5	-

⚠ Non stocké/Non-stored/Producto no estocado - 📦 Sur stock Europe Zone 1 et Zone 2, nous consulter pour délai d'approvisionnement - 📦 Epuisement/Stock depletion/Agotamiento del stock

Béquille de fenêtre / ARCHIMEDE RESIST



GARANTIE

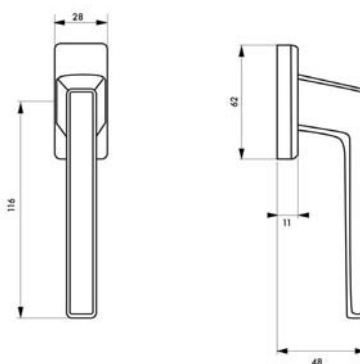

Description/Description/Descripción

Béquille aluminium. Vis de fixation invisibles. Carré acier 7 mm.

Aluminium handle. Invisible fixing screws. Steel Square 7 mm.

Brazo de aluminio. Tornillos de fijación invisibles. Cuadrado acero de 7 mm.

Finition/Finsih/Acabado

Argent F1 / Couleur F2 / Aspect inox F9

Silver / Color F2 / Stainless steel

Plata / Color F2 / Aspecto inoxidable

Designation	Boîte	Colis.	Prix	Sachet	Colis.	Prix	Brochable					Colis.	Prix
							France	Euro 1	Euro 2	Euro 3	Euro 4		
BEQUILLE de fenêtre ARCHIMÉDE Argent F1	00066692	10	-	-	-	-	-	-	-	-	-	-	-
BEQUILLE de fenêtre ARCHIMÉDE couleur F2	00066693	10	-	-	-	-	-	-	-	-	-	-	-
BEQUILLE de fenêtre ARCHIMÉDE Aspect inox F9	00066694	10	-	-	-	-	-	-	-	-	-	-	-

Béquille de fenêtre / GRAN PRIX RESIST



GARANTIE

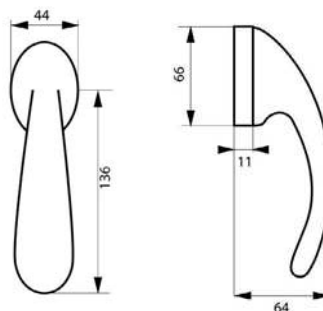

Description/Description/Descripción

Béquille aluminium. Vis de fixation invisibles. Carré acier 7 mm.

Aluminium handle. Invisible fixing screws. Steel Square 7 mm.

Brazo de aluminio. Tornillos de fijación invisibles. Cuadrado acero de 7 mm.

Finition/Finsih/Acabado

Alu perlé argent / Alu poli chromé / Alu noir mat

Alu silver pearl / Alu polished chrome / black matt

Aluminio plata satinado / alu cromado pulido / negro mate

Designation	Boîte	Colis.	Prix	Sachet	Colis.	Prix	Brochable					Colis.	Prix
							France	Euro 1	Euro 2	Euro 3	Euro 4		
BEQUILLE de fenêtre GRAN PRIX Alu Perle Argent	00066612	10	-	-	-	-	-	-	-	-	-	-	-
BEQUILLE de fenêtre GRAN PRIX Alu Poli Chromé	00066613	10	-	-	-	-	-	-	-	-	-	-	-
BEQUILLE de fenêtre GRAN PRIX Alu Noir Mat	00066614	10	-	-	-	-	-	-	-	-	-	-	-

Non stocké/Non-stored/Producto no estocado - Sur stock Europe Zone 1 et Zone 2, nous consulter pour délai d'approvisionnement - Epuement/Stock depletion/Agotamiento del stock



Béquille de fenêtre / FIFTY RESIST



GARANTIE

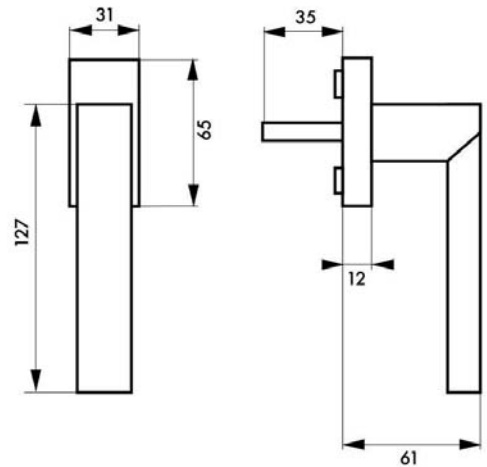

Description/Description/Descripción

Béquille alliage. Vis de fixation invisibles. Carré acier 7 mm.

Alloy handle. Invisible fixing screws. Steel Square 7 mm. Brazo de aleación. Tornillos de fijación invisibles. Cuadrado de acero de 7 mm.

Finition/Finish/Acabado

Chromé poli / Nickelé satiné mat
Chrome plated / Satin nickel matt
Cromado pulido / nickel satinado mate

Version/Option/Versión

Avec cylindre de condamnation 1 clé
With locking disc tumblers 1 key
Con cilindro de condenación de plaquitas de 1 llave

Designation	Boite	Colis.	Prix	Sachet	Colis.	Prix	Brochable					Colis.	Prix
							France	Euro 1	Euro 2	Euro 3	Euro 4		
BEQUILLE de fenêtre FIFTY Chromé poli	00066664	10	-	-	-	-	-	-	-	-	-	-	-
BEQUILLE de fenêtre FIFTY Nickelé satiné mat	00066674	10	-	-	-	-	-	-	-	-	-	-	-
BEQUILLE de fenêtre FIFTY à clé Chromé poli	00066665	10	-	-	-	-	-	-	-	-	-	-	-
BEQUILLE de fenêtre FIFTY à clé Nickelé satiné mat	00066675	10	-	-	-	-	-	-	-	-	-	-	-

⚠ Non stocké/Non-stored/Producto no estocado - 📦 Sur stock Europe Zone 1 et Zone 2, nous consulter pour délai d'approvisionnement - 🇪🇺 Epuisement/Stock depletion/Agotamiento del stock

Béquille de fenêtre / SHARK RESIST



GARANTIE



Description/Description/Descripción

Béquille alliage. Vis de fixation invisibles. Carré acier 7 mm.

Alloy handle. Invisible fixing screws. Steel Square 7 mm. Brazo de aleación. Tornillos de fijación invisibles. Cuadrado acero de 7 mm.

Finition/Finsih/Acabado

Chromé poli / Nickelé satiné mat

Chrome plated / Nickel matt

Cromado pulido / nickel satinado mate

Designation	Boite	Colis.	Prix	Sachet	Colis.	Prix	Brochable					Colis.	Prix
							France	Euro 1	Euro 2	Euro 3	Euro 4		
BEQUILLE de fenêtre SHARK Chromé poli	00066704	10	-	-	-	-	-	-	-	-	-	-	-
BEQUILLE de fenêtre SHARK Nickelé satiné mat	00066714	10	-	-	-	-	-	-	-	-	-	-	-
BEQUILLE de fenêtre SHARK à clé Chromé poli	00066705	10	-	-	-	-	-	-	-	-	-	-	-
BEQUILLE de fenêtre SHARK à clé Nickelé satiné mat	00066715	10	-	-	-	-	-	-	-	-	-	-	-

Non stocké/Non-stored/Producto no estocado - Sur stock Europe Zone 1 et Zone 2, nous consulter pour délai d'approvisionnement - Epuement/Stock depletion/Agotamiento del stock



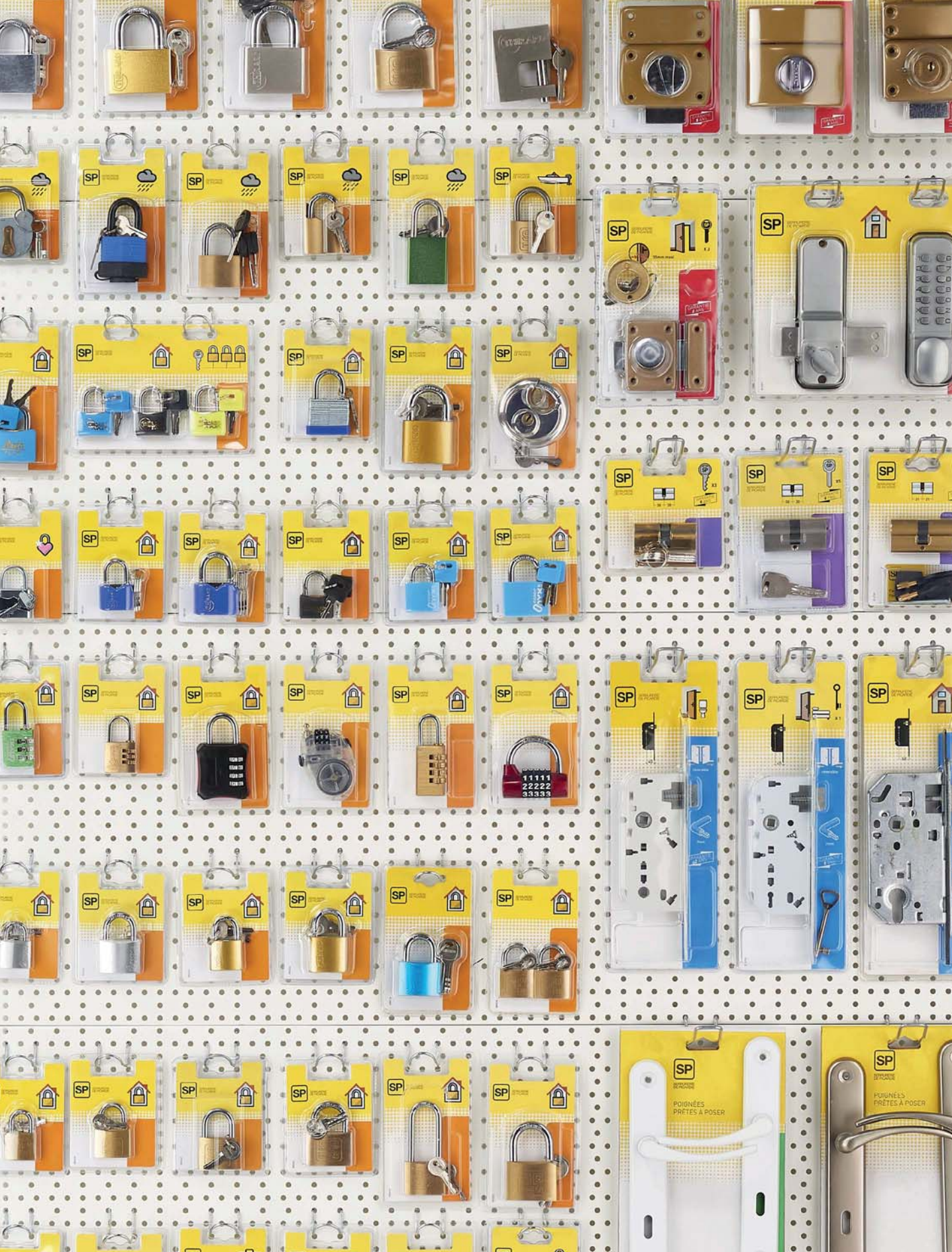

SP & Serruprix





































TARIFICATION



1040 TARIFICATION





































1052

Visuel	Designation	Brochable	Colis	Prix
CADENAS DE BAGAGE				
	CADENAS SP 20 mm anse acier cémenté nickelé 2 clés	00861020	-	-
	CADENAS SP 25 mm anse acier cémenté nickelé 2 clés	00861025	5	-
	CADENAS ALU 20 mm anse acier nickelé 2 clés	00824120	5	-
	CADENAS ALU COLOR 20 mm couleurs assorties anse acier nickelé 2 clés	00824220	10	-
	CADENAS SP 376 31 mm anse acier nickelé 3 chiffres à combinaison modifiable	00837600	5	-
	CADENAS 21 mm SP 118 anse acier nickelé 3 chiffres à combinaison modifiable	00801181	5	-
	CADENAS 30 mm anse acier nickelé 3 chiffres à combinaison modifiable	00871023	5	-
	CADENAS 40 mm anse acier nickelé 4 chiffres à combinaison modifiable	00871024	5	-
	CADENAS 25 mm anse acier nickelé 3 chiffres à combinaison modifiable couleurs assorties	00871014	5	-
	CADENAS 30 mm anse acier nickelé 4 chiffres à combinaison modifiable couleurs assorties	00871015	10	-
	CADENAS 30 mm à câble acier 125 mm 3 chiffres à combinaison modifiable couleurs assorties	00871011	10	-
	CADENAS à câble acier 1000 mm 3 chiffres à combinaison modifiable couleurs assorties	00871010	5	-
	CADENAS TSA 30 mm anse acier nickelé 3 chiffres à combinaison modifiable couleurs assorties	00871020	10	-
	CADENAS TSA 30 mm anse acier nickelé 4 chiffres à combinaison modifiable couleurs assorties	00871021	10	-
	CADENAS TSA 30 mm à câble acier 125 mm 3 chiffres à combinaison modifiable couleurs assorties	00871022	5	-
	CADENAS ALU 20 mm anse acier nickelé 2 clés	00828120	5	-
CADENAS INTERIEUR				
	CADENAS ACERA gris 30 mm anse acier 3 clés	00888002	5	-
	CADENAS ACERA gris 40 mm anse acier 3 clés	00888003	5	-
	CADENAS ACERA gris 50 mm anse acier 3 clés	00888004	5	-
	CADENAS ovale 32 mm anse acier cémenté 3 clés	00886030	5	-
	CADENAS ovale 38 mm anse acier cémenté 3 clés	00886040	5	-
	CADENAS ovale 50 mm anse acier cémenté 3 clés	00886050	5	-
	CADENAS ovale gainé PVC couleurs assorties 30 mm anse acier cémenté 3 clés	00886130	5	-
	CADENAS ovale gainé PVC couleurs assorties 40 mm anse acier cémenté 3 clés	00886140	5	-
	CADENAS ovale gainé PVC couleurs assorties 50 mm anse acier cémenté 3 clés	00886150	5	-
	CADENAS SP 30 mm anse acier cémenté 2 clés	00880030	5	-
	CADENAS SP 35 mm anse acier cémenté 2 clés	00880035	5	-
	CADENAS SP 40 mm anse acier cémenté 2 clés	00880040	5	-
	CADENAS SP 40 mm anse 1/2 haute acier cémenté 2 clés	00880640	5	-
	CADENAS SP 45 mm anse acier cémenté 2 clés	00880045	5	-
	CADENAS SP 50 mm anse acier cémenté 2 clés	00880050	5	-
	LOT DE 2 CADENAS SP 35 mm s'ouvrant anse acier cémenté 4 clés	00880034	5	-
	CADENAS SP COLOR 30 mm couleurs assorties anse acier cémenté 2 clés	00898330	5	-
	CADENAS SP COLOR 40 mm couleurs assorties anse acier cémenté 2 clés	00898100	5	-
	LOT DE 3 CADENAS SP COLOR 30 mm couleurs assorties s'ouvrant anse acier cémenté 6 clés	00898130	5	-
	CADENAS ALU 30 mm anse acier cémenté nickelé 2 clés	00824130	5	-



































Visuel	Designation	Brochable	Colis	Prix
	CADENAS ALU 40 mm anse acier cémenté nickelé 2 clés	00824140	5	-
	CADENAS ALU COLOR 30 mm couleurs assorties anse acier cémenté nickelé 2 clés	00824230	5	-
	CADENAS ALU COLOR 40 mm couleurs assorties anse acier cémenté nickelé 2 clés	00824240	10	-
	CADENAS SP à lamelles 40 mm anse acier cémenté nickelé 2 clés	00890045	5	-
	CADENAS SP 70 mm inox anse acier cémenté 2 clés	00892700	5	-
	CADENAS ALU CODE 30 mm couleurs assorties anse acier nickelé 3 chiffres combinaison modifiable	00812030	5	-
	CADENAS ALU CODE 30 mm silver anse acier nickelé 3 chiffres combinaison modifiable	00812036	5	-
	CÂBLE ENROULEUR 0,55 m 3 chiffres combinaison modifiable	00871003	-	-
	CADENAS OVALE 30 mm anse acier cémenté nickelé 2 clés	00888030	5	-
	CADENAS OVALE 40 mm anse acier cémenté nickelé 2 clés	00888040	10	-
	CADENAS OVALE 50 mm anse acier cémenté nickelé 2 clés	00888050	10	-
	CADENAS BOMBE ALU 40 mm couleurs assorties anse acier cémenté 3 clés	00828114	10	-
	CADENAS BOMBE ALU 50 mm couleurs assorties anse acier cémenté 3 clés	00828115	5	-
	CADENAS VENUS 30 mm anse acier nickelé 3 chiffres à combinaison modifiable	00890801	5	-
	CADENAS VENUS 40 mm anse acier nickelé 4 chiffres à combinaison modifiable	00890802	5	-
	CADENAS SP 258 28 mm anse acier nickelé 4 chiffres à combinaison modifiable	00800258	5	-
	CADENAS SP SATURN couleurs assorties anse acier cémenté nickelé 4 chiffres à combinaison modifiable	00892860	5	-
	CADENAS 40 mm 4 chiffres anse acier nickelé à combinaison modifiable	00871016	5	-
	CÂBLE ENROULEUR inox gainé PVC 0,75 m 2 clés - couleurs assorties	00871002	10	-
CADENAS EXTERIEUR				
	CADENAS SP à lamelles 40 mm gainé PVC anse acier cémenté nickelé 2 clés	00800901	5	-
	CADENAS SP 2493 45 mm anse zinguée 2 clés	00893145	5	-
	CADENAS ALU 30 mm anse acier cémenté nickelé 2 clés	00828130	5	-
	CADENAS ALU 40 mm anse acier cémenté nickelé 2 clés	00828140	5	-
	CADENAS ALU 40 mm anse 1/2 haute acier cémenté nickelé 2 clés	00828142	5	-
	CADENAS ALU 50 mm anse acier cémenté nickelé 2 clés	00828150	5	-
	CADENAS SP REV 40 mm anse acier cémenté nickelé 4 clés réversibles	00861040	5	-
	CADENAS SP 70 mm anse acier chromé 2 clés	00888750	5	-
	CADENAS SP 40P 40 mm anse acier cémenté nickelé 2 clés	00802400	5	-
	CADENAS SP 90 AS 38 mm anse inox 2 clés	00896508	3	-
CADENAS ANTI-CORROSION				
	CADENAS SP 45 mm anse inox 2 clés	00883451	5	-
	CADENAS SP 45 mm anse haute inox 2 clés	00883455	5	-
	CADENAS SP 40 mm gainé PVC anse inox 2 clés	00800900	5	-
CADENAS CHANTIER				
	CADENAS SP 60 mm anse acier cémenté nickelé 2 clés	00880060	5	-
	CADENAS RECTANGULAIRE DISK 40 mm anse acier cémenté nickelé 4 clés	00895515	5	-
	CADENAS RECTANGULAIRE DISK 50 mm anse acier cémenté nickelé 4 clés	00895516	5	-

































Visuel	Designation	Brochure	Colis	Prix
	CADENAS RECTANGULAIRE DISK 60 mm anse acier cémenté nickelé 4 clés	00895517	5	-
	CADENAS RECTANGULAIRE QUADRA 50 mm anse acier cémenté nickelé 4 clés réversibles	00895520	5	-
	CADENAS RECTANGULAIRE QUADRA 60 mm anse acier cémenté nickelé 4 clés réversibles	00895521	5	-
	CADENAS RECTANGULAIRE QUADRA 50 mm anse protégée acier cémenté nickelé 4 clés réversibles	00895522	5	-
	CADENAS RECTANGULAIRE QUADRA 60 mm anse protégée acier cémenté nickelé 4 clés réversibles	00895523	-	-
	CADENAS ALU 60 mm anse acier cémenté nickelé 2 clés	00828160	5	-
	CADENAS BOMBE 60 mm couleurs assorties anse acier cémenté 3 clés	00828116	5	-
	CADENAS BLINDE 74 mm anse acier cémenté 5 clés réversibles	00889740	5	-
CADENAS FUN				
	CADENAS SP 22 35 mm couleurs assorties anse acier zingué 2 clés	00822035	5	-
	MOUSQUETON 3 chiffres combinaison modifiable - couleurs assorties	00871018	5	-
	MOUSQUETON aluminium Ø 6x60 mm (2 pièces sous coque) - couleurs assorties	00806206	5	-
	MOUSQUETON 3 chiffres combinaison modifiable	00871017	5	-
PORTE CADENAS				
	PORTE-CADENAS à recouvrement acier 120 mm avec vis de pose	00844120	5	-
	PORTE-CADENAS à recouvrement acier zingué 100 mm avec vis de pose	00802140	5	-
BOITE A CLÉ				
	BOITE A CLES murale 4 chiffres combinaison modifiable	00871006	5	-
EQUIPEMENT DE PORTE D'ENTRÉE				
	CHAINE DE SECURITE laitonée	00800403	5	-
	CHAINE DE SECURITE nickelée	00800430	5	-
	VERROU ENTREBAILLEUR de porte à chaînette nickelé	00809411	5	-
	ENTREBAILLEUR de porte doré	00800305	5	-
	ENTREBAILLEUR de porte nickelé	00800304	5	-
	ENTREBAILLEUR de porte nickel satin	00809402	10	-
	ENTREBAILLEUR de porte nickel satin pour porte à recouvrement	00809403	-	-
	ENTREBAILLEUR de porte chromé	00813904	5	-
	ENTREBAILLEUR de porte doré	00813906	5	-
	JUDAS optique 160° laiton chromé	00800451	5	-
	JUDAS numérique optique 100°	00812100	1	-
EQUIPEMENT DE PORTE INTÉRIEURE				
	FERME PORTE hydraulique réversible argent pour porte < 60Kg	00894075	2	-
	FERME PORTE hydraulique réversible argent pour porte < 30Kg	00893075	2	-
	ARRET de porte longueur 150 mm laqué argent	00800804	5	-
	VERROU à plaquer à coulisse alliage nickel satin 100 mm	00804151	5	-
	VERROU à onglet zingué pêne rond coulissant 160 mm	00859160	5	-
	BUTOIR de sol plastique Ø 35 mm	00800021	5	-
	BUTOIR de sol caoutchouc Ø 37 mm	00800025	5	-
	BUTOIR balustre plastique longueur 90 mm	00800037	5	-





































Visuel	Designation	Brochable	Colis	Prix
	BUTOIR balustre chromé longueur 80 mm	00800032	5	-
	BUTOIR de sol argent Ø 30 mm hauteur 32 mm	00813046	10	-
	BUTOIR de sol satiné Ø 29 mm hauteur 38 mm	00813044	10	-
	BUTOIR de sol satiné Ø 29 mm hauteur 58 mm	00813045	10	-
EQUIPEMENT DE FENÊTRE				
	ENTREBAILLEUR de fenêtre laqué blanc à 1 ou 2 vantaux	00800402	5	-
	ENTREBAILLEUR de fenêtre chromé à 1 ou 2 vantaux	00800410	5	-
	ENTREBAILLEUR de fenêtre blanc à 1 ou 2 vantaux - 2 clés	00828019	-	-
	ENTREBAILLEUR de fenêtre blanc à 1 ou 2 vantaux - à bouton poussoir	00828018	-	-
	ENTREBAILLEUR de fenêtre blanc à 1 ou 2 vantaux - à cylindre 3 clés	00861411	-	-
EQUIPEMENT DE VOLETS				
	BARRE DE SECURITE 0,46 m zingué avec vis de pose	00808901	5	-
VERROUS PORTE D'ENTRÉE				
	VERROU DE SURETE SP 1010 à bouton et cylindre Ø 21x40 mm bronze 3 clés	00801010	3	-
	VERROU DE SURETE SP 2030 à bouton et cylindre Ø 23x45 mm bronze 3 clés	00802030	3	-
	BOITIER VERROU CP bronze pour cylindre profilé	00803910	5	-
	VERROU DE SURETE SP 2013 à bouton et cylindre Ø 23x45 mm blanc 3 clés	00812013	3	-
	VERROU DE SURETE SP 2012 à bouton et cylindre Ø 23x45 mm noir 3 clés	00812012	3	-
	VERROU DE SURETE SP 3010 à bouton et cylindre Ø 23x40 mm bronze 3 clés	00803010	3	-
	PAIRE VERROUS DE SURETE SP 3010 à bouton et cylindre à goupilles HG 45 mm bronze 6 clés	00803110	2	-
	VERROU DE SURETE CAPOT bouton cylindre 5 goupilles Ø 23x45 mm bronze 3 clés	00871515	2	-
	VERROU DE SURETE CAPOT bouton cylindre 5 goupilles Ø 23x45 mm argent 3 clés	00871516	2	-
	VERROU DE SURETE CAPOT bouton cylindre 5 goupilles Ø 23x45 mm blanc 3 clés	00871517	2	-
	VERROU DE SURETE bouton cylindre 5 goupilles Ø 23x45 mm or 3 clés + cylindre profilé 30x30 mm 3 clés	00883610	5	-
	VERROU DE SURETE double cylindre 5 goupilles Ø 23x45 mm or 3 clés + cylindre profilé 30x30 mm 3 clés	00803620	5	-
	VERROU DE SURETE À CAPOT cylindre à languette 3 clés réversibles	00800959	5	-
	VERROU DE HAUTE SURETE A CAPOT à bouton et cylindre à 6 goupilles Ø 23x45 mm argent 4 clés réversibles	00880452	3	-
	VERROU DE HAUTE SURETE SP 7310 à bouton et cylindre à pompes Ø 23x40 mm bronze 3 clés	00807310	2	-
VERROUS PORTE VITRÉE				
	VERROU DE SURETE SP 1020 à cylindre double à goupilles Ø 21x45 mm bronze 3 clés	00811020	3	-
	VERROU DE SURETE SP 3020 à cylindre double à goupilles Ø 23x40 mm bronze 3 clés	00803020	3	-
	VERROU DE HAUTE SURETE à cylindre double à goupilles Ø 23x45 mm or 4 clés réversibles	00892502	2	-
VERROUS PORTE INTÉRIEURE				
	VERROU DE SURETE SP 956 à bouton et cylindre à goupilles Ø 21 x 35 mm bronze 3 clés	00800956	3	-
	VERROU DE SURETE à bouton et cylindre à goupilles Ø 21 x 35 mm bronze 3 clés	00800945	5	-
	VERROU DE SURETE à bouton et cylindre à goupilles Ø 21 x 45 mm bronze 3 clés	00800946	5	-
	VERROU AUTOMATIQUE sans clé bronze	00802000	3	-
	VERROU À COMBINAISON MECANIQUE avec pêne dormant en applique	00872691	2	-
	VERROU RECTANGULAIRE à voyant libre/occupé pour wc argent	00809038	5	-

Visuel	Designation	Brochable	Colis	Prix
	VERROU INOX à voyant libre/occupé pour wc - porte de 40 mm	00809035	5	-
VERROUS PORTE DE CAVE				
	VERROU DE SURETE SP 1028 sans bouton - cylindre à goupilles Ø 21x40 mm bronze 3 clés	00801028	3	-
VERROUS PORTE DE GARAGE				
	VERROU DE SURETE SP 3014 à bouton et cylindre à goupilles Ø 23x30 mm avec pêne 160 mm bronze 3 clés	00803014	3	-
VERROUS PORTAIL				
	VERROU DE BOX pêne Ø 10 mm	00806060	5	-
	VERROU DE BOX pêne Ø 12 mm	00806080	5	-
	TARGETTE A PORTE CADENAS 50 mm	00809033	5	-
	VERROU DE BOX A PORTE CADENAS pêne Ø 12 mm	00807080	5	-
	VERROU DE BOX A PORTE CADENAS pêne Ø 14 mm	00807090	5	-
VERROUS MEUBLES				
	TARGETTE 30 mm acier zingué pêne plat	00800730	5	-
	TARGETTE 40 mm acier zingué pêne plat	00800740	5	-
	TARGETTE 35 mm acier zingué pêne rond	00802035	5	-
	TARGETTE 45 mm acier zingué pêne rond	00802045	5	-
	TARGETTE 25 mm acier nickelé pêne rond	00800627	5	-
	TARGETTE 35 mm acier nickelé pêne rond	00800635	5	-
	TARGETTE 40 mm acier nickelé pêne rond	00800640	5	-
	VERROU AUTOMATIQUE 30 mm acier zingué pêne plat	00800930	5	-
	VERROU AUTOMATIQUE 35 mm acier zingué pêne plat	00800935	5	-
	VERROU AUTOMATIQUE 40 mm acier zingué pêne plat	00800940	5	-
	TARGETTE 45 mm nickel satin pêne plat	00803045	5	-
	TARGETTE 75 mm acier chromé pêne plat	00802075	5	-
	TARGETTE 100 mm acier chromé pêne plat	00802100	5	-
	TARGETTE 40 mm inox pêne rond	00809031	5	-
	TARGETTE 50 mm inox pêne plat	00813913	5	-
	TARGETTE 75 mm inox pêne plat	00813914	5	-
	TARGETTE 65 mm inox pêne plat	00813915	5	-
	TARGETTE 75 mm nickel satin pêne rond	00803075	5	-
	TARGETTE 100 mm nickel satin pêne rond	00803100	5	-
	TARGETTE 200 mm nickel satin pêne rond	00803200	5	-
	TARGETTE 50 mm nickel satin pêne rond	00804052	5	-
	TARGETTE 60 mm nickel satin pêne rond	00804062	5	-
	TARGETTE 75 mm nickel satin pêne rond	00804072	5	-
	TARGETTE 100 mm nickel satin pêne rond	00804102	5	-
	TARGETTE 30 mm laiton pêne rond	00800830	5	-
	TARGETTE 40 mm laiton pêne rond	00800840	5	-







Visuel	Designation	Brochable	Colis	Prix
	TARGETTE 30 mm laiton chromé pêne rond	00800831	5	-
	TARGETTE 40 mm laiton chromé pêne rond	00800841	5	-
	TARGETTE 50 mm laiton chromé pêne rond	00800851	5	-
	TARGETTE 70 mm laiton chromé pêne rond	00800871	5	-
	TARGETTE 30 mm laiton laqué blanc pêne rond	00800832	5	-
	TARGETTE 40 mm laiton laqué blanc pêne rond	00800842	5	-
	VERROU AUTOMATIQUE 30 mm bronze	00800932	5	-
	VERROU AUTOMATIQUE 40 mm bronze	00800942	5	-
	VERROU AUTOMATIQUE 50 mm bronze	00800952	5	-
VERROUS FENÊTRE				
	LOQUETEAU de fenêtre laqué blanc	00800423	5	-
	LOQUETEAU de fenêtre laqué blanc avec alarme sonore	00812060	5	-
ACCESSOIRES				
	LUBRIFIANT poudre graphite 95 ml pour cylindre	00896005	5	-
CYLINDRES CLÉS CRANTÉES				
	DEMI CYLINDRE PROFILE européen 30x10 mm laiton 3 clés	00815940	5	-
	CYLINDRE PROFILE européen 30x30 mm laiton 3 clés	00816260	5	-
	CYLINDRE PROFILE européen 35x35 mm laiton 3 clés	00816270	5	-
	CYLINDRE PROFILE européen 40x40 mm laiton 3 clés	00816280	5	-
	CYLINDRE PROFILE européen 30x40 mm laiton 3 clés	00816265	5	-
	CYLINDRE PROFILE européen 30x60 mm laiton 3 clés	00816287	5	-
	CYLINDRE PROFILE européen 35x45 mm laiton 3 clés	00816292	5	-
	CYLINDRE PROFILE européen à bouton 30x30 mm laiton 3 clés	00814060	5	-
	COQUE DE 2 CYLINDRES PROFILE européen 30x30 mm laiton s'ouvrant 6 clés	00816263	5	-
	CYLINDRE PROFILE européen nickelé 30x30 mm 3 clés	00816261	5	-
	CYLINDRE PROFILE européen 30x40 mm nickelé 3 clés	00816266	5	-
	CYLINDRE PROFILE européen 35x35 mm nickelé 3 clés	00816271	5	-
	CYLINDRE PROFILE européen 40x40 mm nickelé 3 clés	00816283	5	-
	CYLINDRE PROFILE européen 30x50 mm nickelé 3 clés	00816282	5	-
	CYLINDRE PROFILE européen 35x45 mm nickelé 3 clés	00816294	5	-
	CYLINDRE PROFILE européen bouton 30x30 mm nickelé 3 clés	00814061	5	-
	2 CYLINDRES PROFILE européen 30x30 mm nickelé s'ouvrant 6 clés	00816262	5	-
	CYLINDRE PROFILE européen 30x60 mm nickelé 3 clés	00816288	5	-
CYLINDRES CLÉS RÉVERSIBLES				
	CYLINDRE PROFILE européen SHG 30x30 mm 4 clés réversibles	00818759	3	-
	CYLINDRE PROFILE européen SHG 30x40 mm 4 clés réversibles	00818769	3	-
	CYLINDRE PROFILE européen T6 35x45 mm nickelé 5 clés réversibles	00817781	5	-
CYLINDRES À POMPES				
	CYLINDRE PROFILE européen SPS 31X31 mm à pompes 4 clés à insert laiton	00816730	3	-

Visuel	Designation	Brochable	Colis	Prix
BATTEUSES BOITE AUX LETTRES				
	BATTEUSE nickelée avec came 12 h pour tôle 0,8 à 1,2 mm 2 clés	00817914	5	-
	BATTEUSE nickelée avec came 12 h coudée vers la face pour tôle 0,8 à 1,2 mm 2 clés	00817915	5	-
	BATTEUSE nickelée longueur 20 mm pour épaisseur maxi 14 mm 2 clés	00817920	5	-
	BATTEUSE BAL compatible avec la distribution postale pour épaisseur maxi 23 mm 2 clés	00828301	5	-
SERRURES POUR MEUBLE				
	SERRURE A PATTES acier laitonné 30 mm 1 clé	00800231	5	-
	SERRURE A PATTES acier laitonné 40 mm 1 clé	00800241	5	-
	SERRURE A PATTES acier laitonné 50 mm 1 clé	00800251	5	-
	SERRURE A PATTES acier poli 30 mm 1 clé	00800232	5	-
	SERRURE A PATTES acier poli 50 mm 1 clé	00800252	5	-
	SERRURE EN APPLIQUE nickelé cylindre à paillettes longueur 20 mm 2 clés	00802402	5	-
SERRURES À ENCASTRER PORTE D'ENTRÉE				
	BOITIER SERRURE à cylindre axe 40 mm réversible V/BR	00800106	10	-
	BOITIER SERRURE à cylindre axe 50 mm réversible V/BC/L	00800506	10	-
	BOITIER SERRURE à cylindre axe 50 mm réversible V/BR	00856830	5	-
	SERRURE à cylindre axe 10,5mm entr'axe 70 mm réversible 3 clés	00800721	5	-
	BOITIER SERRURE à cylindre axe 21 mm entr'axe 70 mm réversible	00811735	5	-
SERRURES À ENCASTRE PORTE INTÉRIEURE				
	SERRURE bec de cane axe 40 mm réversible V/BR	00800100	5	-
	SERRURE bec de cane axe 40 mm magnétique réversible Z/BR	00801150	5	-
	SERRURE à condamnation axe 40 mm réversible V/BR	00800101	5	-
	SERRURE à condamnation axe 40 mm magnétique réversible Z/BR	00801151	5	-
	SERRURE pêne dormant 1/2 tour axe 40 mm réversible V/BR 1 clé	00800102	5	-
	SERRURE pêne dormant 1/2 tour axe 40 mm magnétique réversible Z/BR 1 clé	00801152	5	-
	SERRURE pêne dormant 1/2 tour axe 40 mm 3 gorges réversible V/BR 2 clés	00800103	5	-
	SERRURE A CROCHET à condamnation axe 50 mm chromé satin pour porte coulissante	00801108	5	-
SERRURES À APPLIQUER PORTE D'ENTRÉE				
	SERRURE horizontale emboutie à tirage 140x90 mm noire droite 3 clés	00800115	2	-
	SERRURE horizontale emboutie à tirage 140x90 mm noire gauche 3 clés	00800125	2	-
	SERRURE horizontale emboutie à fouillot 140x90 mm noire droite 3 clés	00800116	2	-
	SERRURE horizontale emboutie à fouillot 140x90 mm noire gauche 3 clés	00800126	2	-
	SERRURE verticale emboutie à fouillot 75x120 mm noire droite 3 clés	00800136	2	-
	SERRURE verticale emboutie à fouillot 75x120 mm noire gauche 3 clés	00800146	2	-
	BOITIER SERRURE horizontale emboutie à fouillot 140x88 mm noire droite	00809766	2	-
	BOITIER SERRURE horizontale emboutie à fouillot 140x88 mm noire gauche	00809776	2	-

Visuel	Designation	Brochable	Colis	Prix
	SERRURE 3 points VCR à tirage bronze droite 4 clés	00850010	1	-
	SERRURE 3 points VCR à tirage bronze gauche 4 clés	00850020	1	-
	SERRURE 3 points CR à fouillot bronze droite 4 clés	00850110	1	-
	SERRURE 3 points CR à fouillot bronze gauche 4 clés	00850120	1	-
	SERRURE 3 points CR à fouillot bronze droite 4 clés réversibles	00860110	1	-
	SERRURE 3 points CR à fouillot bronze gauche 4 clés réversibles	00860120	1	-
SERRURES À APPLIQUER PORTE INTÉRIEURE				
	SERRURE horizontale pêne dormant 1/2 tour 140x80 mm noire droite 1 clé	00800111	2	-
	SERRURE horizontale pêne dormant 1/2 tour 140x80 mm noire gauche 1 clé	00800121	2	-
	SERRURE verticale pêne dormant 1/2 tour 70x110 mm noire droite 1 clé	00800131	2	-
	SERRURE verticale pêne dormant 1/2 tour 70x110 mm noire gauche 1 clé	00800141	2	-
SERRURES À APPLIQUER PORTAIL				
	SERRURE horizontale pêne dormant 1/2 tour 140x80 mm zingué droite 2 clés	00800119	5	-
	SERRURE horizontale pêne dormant 1/2 tour 140x80 mm zingué gauche 2 clés	00800129	5	-
	SERRURE verticale pêne dormant 1/2 tour 70x110 mm zingué droite 2 clés	00800130	2	-
	SERRURE verticale pêne dormant 1/2 tour 70x110 mm zingué gauche 2 clés	00800140	2	-
POIGNÉES PORTE INTÉRIEURE				
	ENSEMBLE chromé ARES entr'axe de fixation 165 mm sans trou	00843300	5	-
	ENSEMBLE chromé ARES entr'axe de fixation 165 mm à condamnation	00843301	5	-
	ENSEMBLE chromé ARES entr'axe de fixation 165 mm trou de clé	00843302	5	-
	ENSEMBLE chromé ARES entr'axe de fixation 165 mm trou de cylindre	00843303	5	-
	ENSEMBLE chromé DEMETER entr'axe de fixation 195 mm sans trou	00843310	5	-
	ENSEMBLE chromé DEMETER entr'axe de fixation 195 mm à condamnation	00843311	5	-
	ENSEMBLE chromé DEMETER entr'axe de fixation 195 mm trou de clé	00843312	5	-
	ENSEMBLE chromé DEMETER entr'axe de fixation 195 mm trou de cylindre	00843313	5	-
	ENSEMBLE blanc HEBE entr'axe de fixation 195 mm sans trou	00843360	5	-
	ENSEMBLE blanc HEBE entr'axe de fixation 195 mm à condamnation	00843361	5	-
	ENSEMBLE blanc HEBE entr'axe de fixation 195 mm trou de clé	00843362	5	-
	ENSEMBLE blanc HEBE entr'axe de fixation 195 mm trou de cylindre	00843363	5	-
	ENSEMBLE laiton patiné ARTHEMIS entr'axe de fixation 195 mm sans trou	00843350	5	-
	ENSEMBLE laiton patiné ARTHEMIS entr'axe de fixation 195 mm à condamnation	00843351	5	-
	ENSEMBLE laiton patiné ARTHEMIS entr'axe de fixation 195 mm trou de clé	00843352	5	-
	ENSEMBLE laiton patiné ARTHEMIS entr'axe de fixation 195 mm trou de cylindre	00843353	5	-
	ENSEMBLE aluminium LETO entr'axe de fixation 165 mm sans trou F1 argent	00890190	5	-
	ENSEMBLE aluminium LETO entr'axe de fixation 165 mm à condamnation F1 argent	00890191	5	-
	ENSEMBLE aluminium LETO entr'axe de fixation 165 mm à clé F1 argent	00890192	5	-
ENSEMBLE aluminium LETO entr'axe de fixation 165 mm trou de cylindre F1 argent	00890193	5	-	

Visuel	Designation	Brochable	Colis	Prix
	ENSEMBLE aluminium LETO entr'axe de fixation 165 mm sans trou couleur F2	00890194	5	-
	ENSEMBLE aluminium LETO entr'axe de fixation 165 mm à condamnation couleur F2	00890195	5	-
	ENSEMBLE aluminium LETO entr'axe de fixation 165 mm trou de clé couleur F2	00890196	5	-
	ENSEMBLE aluminium LETO entr'axe de fixation 165 mm trou de cylindre couleur F2	00890197	5	-
	ENSEMBLE aluminium SELENE entr'axe de fixation 195 mm sans trou	00890230	5	-
	ENSEMBLE aluminium SELENE entr'axe de fixation 195 mm à condamnation	00890231	5	-
	ENSEMBLE aluminium SELENE entr'axe de fixation 195 mm trou de clé	00890232	5	-
	ENSEMBLE aluminium SELENE entr'axe de fixation 195 mm trou de cylindre	00890233	5	-
	ENSEMBLE aluminium VESTA entr'axe de fixation 165 mm sans trou	00890351	5	-
	ENSEMBLE aluminium VESTA entr'axe de fixation 165 mm à condamnation	00890352	5	-
	ENSEMBLE aluminium VESTA entr'axe de fixation 165 mm trou de clé	00890353	5	-
	ENSEMBLE aluminium VESTA entr'axe de fixation 165 mm trou de cylindre	00890354	5	-
	ENSEMBLE aluminium VESTA entr'axe de fixation 195 mm sans trou	00890355	5	-
	ENSEMBLE aluminium VESTA entr'axe de fixation 195 mm à condamnation	00890356	5	-
	ENSEMBLE aluminium VESTA entr'axe de fixation 195 mm trou de clé	00890357	5	-
	ENSEMBLE aluminium VESTA entr'axe de fixation 195 mm trou de cylindre	00890358	5	-
	ENSEMBLE aluminium MAIA entr'axe de fixation 195 mm sans trou F1	00899200	5	-
	ENSEMBLE aluminium MAIA entr'axe de fixation 195 mm à condamnation F1 argent	00890201	5	-
	ENSEMBLE aluminium MAIA entr'axe de fixation 195 mm trou de clé F1 argent	00890202	5	-
	ENSEMBLE aluminium MAIA entr'axe de fixation 195 mm trou de cylindre F1 argent	00890203	5	-
	ENSEMBLE aluminium MAIA entr'axe de fixation 195 mm sans trou couleur F2	00890204	5	-
	ENSEMBLE aluminium MAIA entr'axe de fixation 195 mm à condamnation couleur F2	00890205	5	-
	ENSEMBLE aluminium MAIA entr'axe de fixation 195 mm trou de clé couleur F2	00890206	5	-
	ENSEMBLE aluminium MAIA entr'axe de fixation 195 mm trou de cylindre couleur F2	00890207	5	-
	ENSEMBLE acier rouillé CHARON entr'axe de fixation 195 mm rouille sans trou	00843380	5	-
	ENSEMBLE acier rouillé CHARON entr'axe de fixation 195 mm à condamnation	00843381	5	-
	ENSEMBLE acier rouillé CHARON entr'axe de fixation 195 mm trou de clé	00843382	5	-
	ENSEMBLE acier rouillé CHARON entr'axe de fixation 195 mm trou de cylindre	00843383	5	-
	ENSEMBLE acier patiné CHARON entr'axe de fixation 195 mm sans trou	00843384	5	-
	ENSEMBLE acier patiné CHARON entr'axe de fixation 195 mm à condamnation	00843385	5	-
	ENSEMBLE acier patiné CHARON entr'axe de fixation 195 mm trou de clé	00843386	5	-
	ENSEMBLE acier patiné CHARON entr'axe de fixation 195 mm trou de cylindre	00843387	5	-
	ENSEMBLE nickelé brossé ATHENA entr'axe de fixation 195 mm sans trou	00843340	5	-
	ENSEMBLE nickelé brossé ATHENA entr'axe de fixation 195 mm à condamnation	00843341	5	-
	ENSEMBLE nickelé brossé ATHENA entr'axe de fixation 195 mm trou de clé	00843342	5	-
	ENSEMBLE nickelé brossé ATHENA entr'axe de fixation 195 mm trou de cylindre	00843343	5	-
	ENSEMBLE nickelé satiné HELIOS entr'axe de fixation 195 mm sans trou	00843410	5	-

Visuel	Designation	Brochable	Colis	Prix
	ENSEMBLE nickelé satiné HELIOS entr'axe de fixation 195 mm à condamnation	00843411	5	-
	ENSEMBLE nickelé satiné HELIOS entr'axe de fixation 195 mm trou de clé	00843412	5	-
	ENSEMBLE nickelé satiné HELIOS entr'axe de fixation 195 mm trou de cylindre	00843413	5	-
POIGNÉES PORTE D'ENTRÉE				
	BOUTON DOUBLE carré de 6 mm 1 portée	00800480	5	-
	BEQUILLE DOUBLE carré de 7 mm 2 portées	00800469	5	-
	BEQUILLE DOUBLE carré de 6mm 1 portée	00800468	5	-
	BEQUILLE DOUBLE aluminium torsadé carré de 7x70 mm noir 2 portées	00807700	5	-
	BOUTON DOUBLE fonte carré de 6 mm	00808728	5	-
	BEQUILLE DOUBLE couleur F2 carré de 7 mm 1 portée	00804470	5	-
	PAIRE ROSACES blanc trou de cylindre	00800511	5	-
POIGNÉES PORTE INTÉRIEURE				
	BEQUILLE DOUBLE nickelé satiné carré de 7 mm	00890301	10	-
	BEQUILLE DOUBLE laitonné carré de 7 mm	00890302	10	-
	BEQUILLE DOUBLE nickelé satiné carré de 7 mm avec rosaces	00890303	10	-
	BEQUILLE DOUBLE noir carré de 7 mm	00890304	10	-
	BEQUILLE DOUBLE inox carré de 7 mm avec rosaces	00890305	10	-
	BEQUILLE DOUBLE inox carré de 7 mm avec rosaces	00890306	10	-
	BEQUILLE DOUBLE JUNON nickelé brossé carré de 7 mm	00890363	10	-
	BEQUILLE DOUBLE laitonée carré de 7 mm	00890300	10	-
	BEQUILLE DOUBLE PORCELAINE carré de 7 mm	00800471	5	-
	PAIRE ROSACES couleur F2 à clé	00890320	10	-
	PAIRE ROSACES couleur F2 trou de cylindre	00890321	10	-
	PAIRE ROSACES couleur F2 à condamnation	00890322	10	-
	PAIRE ROSACES F1 argent à clé	00890323	10	-
	PAIRE ROSACES F1 argent trou de cylindre	00890324	10	-
	PAIRE ROSACES F1 argent à condamnation	00890325	10	-
	PAIRES ROSACES nickelé satiné à clé	00890364	10	-
	PAIRE ROSACES nickelé satiné trou de cylindre	00890365	10	-
	PAIRE ROSACES nickelé satiné à condamnation	00890366	10	-
	PAIRE ROSACES inox à clé	00890340	10	-
	PAIRE ROSACES inox trou de cylindre	00890341	10	-
	PAIRE ROSACES inox à condamnation	00890342	10	-
POIGNÉES FENÊTRE				
	BOUTON FENETRE COQ noir carré de 7 mm	00890310	10	-
	BOUTON FENETRE ARTHEMIS laiton carré de 7 mm	00890311	10	-
	BOUTON FENETRE SELENE nickelé satiné carré de 7 mm	00890312	10	-
	BOUTON FENETRE HEBE blanc carré de 7 mm	00890313	10	-

Visuel	Designation	Brochable	Colis	Prix
	BOUTON FENETRE LETO/MAIA couleur F2 carré de 7 mm	00890314	10	-
	BOUTON FENETRE LETO/MAIA couleur F2 carré de 7 mm	00890315	10	-
	BOUTON FENETRE LETO/MAIA couleur F2 carré de 7 mm	00890316	10	-
	BOUTON ENTREBAILLEUR FENETRE couleur F2 carré de 7 mm	00800474	5	-
	BOUTON POUR FENETRE aluminium anodisé couleur F2 avec vis de pose carré de 7 mm	00800473	5	-
	BEQUILLE POUR FENETRE aluminium laqué blanc avec vis de pose carré de 7 mm	00800478	5	-



Visuel	Designation	Boite	Colis.	Prix	Sachet	Colis.	Prix	Brochable	Colis.	Prix
--------	-------------	-------	--------	------	--------	--------	------	-----------	--------	------

CADENAS DE SURETÉ À GOUPILLES

	BASIC 20 mm anse acier 2 clés	-	-	-	00979020	10	-	00970020	10	-
	BASIC 25 mm anse acier 2 clés	-	-	-	00979025	10	-	00970025	10	-
	BASIC 30 mm anse acier 2 clés	-	-	-	00979030	10	-	00970030	10	-
	BASIC 30 mm anse acier 1/2 haute 44 mm 2 clés	-	-	-	00979130	10	-	-	-	-
	BASIC 35 mm anse acier 2 clés	-	-	-	00979035	10	-	00970035	10	-
	BASIC 40 mm anse acier 2 clés	-	-	-	00979040	10	-	00970040	10	-
	BASIC 40 mm anse acier 1/2 haute 48 mm 2 clés	-	-	-	00979140	10	-	00970140	10	-
	BASIC 45 mm anse acier 2 clés	-	-	-	00979045	10	-	00970045	10	-
	BASIC 50 mm anse acier 2 clés	-	-	-	00979050	10	-	00970050	10	-
	BASIC 60 mm anse acier 2 clés	-	-	-	00979060	10	-	00970060	10	-
	LOT DE 2 CADENAS BASIC 40 mm s'ouvrant anse acier 4 clés	-	-	-	00979240	10	-	00970240	10	-
	LOT DE 3 CADENAS BASIC 30 mm s'ouvrant anse acier dont 1 offert 6 clés	-	-	-	-	-	-	00970330	10	-
	LOT DE 3 CADENAS BASIC 20 - 30 - 40 mm anse acier 6 clés	-	-	-	-	-	-	00150234	10	-

CADENAS DE SURETÉ À GOUPILLES

	ACERA 25 mm anse acier cémenté 3 clés	-	-	-	00998001	10	-	00980001	10	-
	ACERA 30 mm anse acier cémenté 3 clés	-	-	-	00998002	10	-	00980002	10	-
	ACERA 40 mm anse acier cémenté 3 clés	-	-	-	00998003	10	-	00980003	10	-
	ACERA 50 mm anse acier cémenté 3 clés	-	-	-	00998004	10	-	00980004	10	-
	ACERA 60 mm anse acier cémenté 3 clés	-	-	-	00998005	10	-	00980005	10	-

CADENAS DE SURETÉ À GOUPILLES

	ACERA 60 mm anse protégée acier cémenté 3 clés à disques	-	-	-	-	-	-	00980006	10	-
---	--	---	---	---	---	---	---	----------	----	---

CADENAS DE SURETÉ À GOUPILLES

	ACERA 75 mm rectangulaire anse acier cémenté 3 clés	-	-	-	-	-	-	00980007	10	-
---	---	---	---	---	---	---	---	----------	----	---

CADENAS DE SURETÉ À GOUPILLES

	ACERA gris 25 mm anse acier cémenté 3 clés	-	-	-	00988001	10	-	00988101	10	-
	ACERA gris 30 mm anse acier cémenté 3 clés	-	-	-	00988002	10	-	00988102	10	-
	ACERA gris 40 mm anse acier cémenté 3 clés	-	-	-	00988003	10	-	00988103	10	-
	ACERA gris 40 mm anse acier cémenté 1/2 haute 61 mm 3 clés	-	-	-	00988043	10	-	00988143	10	-
	ACERA gris 50 mm anse acier cémenté 3 clés	-	-	-	00988004	10	-	00988104	10	-
	ACERA gris 50 mm anse acier cémenté 1/2 haute 72 mm 3 clés	-	-	-	00988054	10	-	00988154	10	-
	ACERA gris 60 mm anse acier cémenté 3 clés	-	-	-	00988005	10	-	00988105	10	-
	ACERA gris 60 mm anse acier cémenté 1/2 haute 79 mm 3 clés	-	-	-	00988065	10	-	00988165	10	-
	ACERA gris 75 mm anse acier cémenté 3 clés	-	-	-	00988007	10	-	00988107	10	-
	LOT DE 3 ACERA gris 30 mm s'ouvrant anse acier cémenté 9 clés	-	-	-	-	-	-	00988230	10	-
	LOT DE 3 ACERA gris 40 mm s'ouvrant anse acier cémenté 9 clés	-	-	-	-	-	-	00988240	10	-
	LOT DE 3 ACERA gris 50 mm s'ouvrant anse acier cémenté 9 clés	-	-	-	-	-	-	00988250	10	-

Attention : tous les produits sont livrés en recharge de bac de présentation
Pour fournir le bac, saisir SX + le code produit dans le dépôt 55

Visuel	Designation	Boite	Colis.	Prix	Sachet	Colis.	Prix	Brochable	Colis.	Prix
--------	-------------	-------	--------	------	--------	--------	------	-----------	--------	------

VERROU

	VERROU AUTOMATIQUE cambré	-	-	-	00900632	20	-	00200632	30	-
	VERROU cambré à bouton et cylindre Ø 25 x 40 mm 3 clés	-	-	-	00900658	15	-	00200658	30	-
	VERROU cambré à double cylindre Ø 25 x 40 mm 3 clés	-	-	-	00900220	15	-	00200220	30	-
	LOT DE 2 VERROUS cambrés à double cylindre Ø 25 x 40 mm s'ouvrant 6 clés	-	-	-	-	-	-	00402220	15	-

VERROU DE SURETÉ

	9401 à bouton et cylindre Ø 23 x 45 mm 3 clés	-	-	-	00909401	15	-	00259401	30	-
	9404 à double cylindre Ø 23 x 45 mm 3 clés	-	-	-	00919404	15	-	00259404	30	-
	LOT DE 2 VERROUS 9401 à bouton et cylindre Ø 23 x 45 mm s'ouvrant 6 clés	-	-	-	-	-	-	00829401	8	-
	LOT DE 3 VERROUS 9401 à bouton et cylindre Ø 23 x 40 mm s'ouvrant 9 clés	-	-	-	-	-	-	00550231	3	-
	9259 à bouton et cylindre Ø 23 x 45 mm 4 clés réversibles	-	-	-	-	-	-	00259259	20	-
	9259 à bouton et cylindre Ø 23 x 45 mm et cylindre profilé 30 x 30 mm MV 8 clés réversibles	-	-	-	-	-	-	00259659	10	-

Attention : tous les produits sont livrés en recharge de bac de présentation
Pour fournir le bac, saisir SX + le code produit dans le dépôt 55

Visuel	Designation	Boite	Colis.	Prix	Sachet	Colis.	Prix	Brochable	Colis.	Prix
--------	-------------	-------	--------	------	--------	--------	------	-----------	--------	------

CYLINDRE

	DEMI CYLINDRE PROFILE européen 5 goupilles doré 30 x 10 mm 3 clés	00007949	10	-	00905949	10	-	00105949	10	-
	DEMI CYLINDRE PROFILE européen 5 goupilles doré 40 x 10 mm 3 clés	00007950	10	-	-	-	-	-	-	-
	DEMI CYLINDRE PROFILE européen 5 goupilles doré 50 x 10 mm 3 clés	00007951	10	-	-	-	-	-	-	-
	CYLINDRE PROFILE européen 5 goupilles doré 27 x 27 mm 3 clés	-	-	-	00906249	10	-	-	-	-
	CYLINDRE PROFILE européen 5 goupilles doré 30 x 30 mm 3 clés	00007259	10	-	00906259	10	-	00106259	10	-
	CYLINDRE PROFILE européen 5 goupilles doré 35 x 35 mm 3 clés	00007269	10	-	00906279	10	-	00106279	10	-
	CYLINDRE PROFILE européen 5 goupilles doré 40 x 40 mm 3 clés	00007189	10	-	00906280	10	-	00106280	10	-
	CYLINDRE PROFILE européen 5 goupilles doré 45 x 45 mm 3 clés	00007394	10	-	00906394	10	-	-	-	-
	CYLINDRE PROFILE européen 5 goupilles doré 30 x 35 mm 3 clés	-	-	-	00906265	10	-	00106265	10	-
	CYLINDRE PROFILE européen 5 goupilles doré 30 x 40 mm 3 clés	00007279	10	-	00906269	10	-	00106269	10	-
	CYLINDRE PROFILE européen 5 goupilles doré 30 x 50 mm 3 clés	00007289	10	-	00906282	10	-	00106282	10	-
	CYLINDRE PROFILE européen 5 goupilles doré 30 x 60 mm 3 clés	00007299	10	-	00906299	10	-	-	-	-
	CYLINDRE PROFILE européen 5 goupilles doré 30 x 70 mm 3 clés	00007109	10	-	-	-	-	-	-	-
	CYLINDRE PROFILE européen 5 goupilles doré 35 x 45 mm 3 clés	00007295	10	-	00906281	10	-	00106281	10	-
	CYLINDRE PROFILE européen 5 goupilles doré 35 x 50 mm 3 clés	00007395	10	-	00906395	10	-	-	-	-
	CYLINDRE PROFILE européen 5 goupilles doré 35 x 55 mm 3 clés	00007312	10	-	00906312	10	-	-	-	-
	CYLINDRE PROFILE européen 5 goupilles doré 40 x 30 mm 3 clés	-	-	-	00904070	10	-	-	-	-
	CYLINDRE PROFILE européen 5 goupilles doré 40 x 50 mm 3 clés	N0007290	10	-	00906290	10	-	-	-	-
	CYLINDRE. PROF. européen à bouton 5 goupilles doré 30 x 30 mm 3 clés	00007069	10	-	00904069	10	-	00104069	10	-
	CYLINDRE. PROF. européen à bouton 5 goupilles doré 30 x 40 mm 3 clés	N0007079	10	-	-	-	-	-	-	-
CYLINDRE. PROF. européen à bouton 5 goupilles doré 40 x 30 mm 3 clés	N0007179	10	-	-	-	-	-	-	-	
PAIRE DE CYLINDRE PROFILE européen 5 goupilles doré 30 x 30 mm 6 clés	-	-	-	00926259	10	-	00126259	10	-	

CYLINDRE

	DEMI CYLINDRE PROFILE européen chromé 5 goupilles 30 x 10 mm 3 clés	00007948	10	-	00904949	10	-	00107949	10	-
	DEMI CYLINDRE PROFILE européen chromé 5 goupilles 40 x 10 mm 3 clés	00007952	10	-	-	-	-	-	-	-
	DEMI CYLINDRE PROFILE européen chromé 5 goupilles 50 x 10 mm 3 clés	00007953	10	-	-	-	-	-	-	-
	CYLINDRE PROFILE européen 5 goupilles chromé 30 x 30 mm 3 clés	00007258	10	-	00904259	10	-	00107259	10	-
	CYLINDRE PROFILE européen 5 goupilles chromé 35 x 35 mm 3 clés	00007268	10	-	00904279	10	-	00107269	10	-
	CYLINDRE PROFILE européen 5 goupilles chromé 40 x 40 mm 3 clés	00007190	10	-	00904280	10	-	00107189	10	-
	CYLINDRE PROFILE européen 5 goupilles chromé 45 x 45 mm 3 clés	00007397	10	-	00904394	10	-	00107394	10	-
	CYLINDRE PROFILE européen 5 goupilles chromé 30 x 40 mm 3 clés	00007278	10	-	00904269	10	-	00107279	10	-
	CYLINDRE PROFILE européen 5 goupilles chromé 30 x 50 mm 3 clés	00007286	10	-	00904282	10	-	00104282	10	-
	CYLINDRE PROFILE européen 5 goupilles chromé 30 x 60 mm 3 clés	00007391	10	-	-	-	-	-	-	-
	CYLINDRE PROFILE européen 5 goupilles chromé 30 x 70 mm 3 clés	00007371	10	-	-	-	-	-	-	-
	CYLINDRE PROFILE européen 5 goupilles chromé 35 x 45 mm 3 clés	N0007296	10	-	00904281	10	-	00107295	10	-

Attention : tous les produits sont livrés en recharge de bac de présentation
Pour fournir le bac, saisir SX + le code produit dans le dépôt 55

Visuel	Designation	Boite	Colis.	Prix	Sachet	Colis.	Prix	Brochable	Colis.	Prix
	CYLINDRE PROFILE européen 5 goupilles chromé 35 x 50 mm 3 clés	00007396	10	-	00904395	10	-	00107395	10	-
	CYLINDRE PROFILE européen 5 goupilles chromé 35 x 55 mm 3 clés	00007313	10	-	00904312	10	-	00107312	10	-
	CYLINDRE PROFILE européen 5 goupilles chromé 40 x 50 mm 3 clés	00007398	10	-	00904290	10	-	-	-	-
	CYLINDRE PROFILE européen à bton 5 goupilles chromé 30 x 30 mm 3 clés	00007068	10	-	00904169	10	-	00104169	10	-
	PAIRE DE CYLINDRES PROFILES européen 5 goupilles chromé 30 x 30 mm 6 clés MV	-	-	-	00924259	10	-	00124259	10	-

CYLINDRE DE SURETÉ

	DEMI-CYLINDRE PROFILE européen 5 goupilles 30 x 10 mm finition laitonée 5 clés réversibles	00016600	10	-	-	-	-	00216600	10	-
	CYLINDRE PROFILE européen 5 goupilles 30 x 30 mm finition laitonée 5 clés réversibles	00016602	10	-	-	-	-	00216602	10	-
	CYLINDRE PROFILE européen 5 goupilles 35 x 35 mm finition laitonée 5 clés réversibles	00016606	10	-	-	-	-	00216606	10	-
	CYLINDRE PROFILE européen 5 goupilles 40 x 40 mm finition laitonée 5 clés réversibles	00016604	10	-	-	-	-	00216604	10	-
	CYLINDRE PROFILE européen 5 goupilles 30 x 40 mm finition laitonée 5 clés réversibles	00016603	10	-	-	-	-	00216603	10	-
	CYLINDRE PROFILE européen 5 goupilles 30 x 50 mm finition laitonée 5 clés réversibles	00093763	10	-	-	-	-	00293763	10	-
	CYLINDRE PROFILE européen 5 goupilles 30 x 60 mm finition laitonée 5 clés réversibles	00016609	10	-	-	-	-	00216609	10	-
	CYLINDRE PROFILE européen 5 goupilles 35 x 45 mm finition laitonée 5 clés réversibles	00016605	10	-	-	-	-	00216605	10	-
	CYLINDRE PROFILE européen 5 goupilles à bouton 30 x 30 mm finition laitonée 5 clés réversibles	00016601	10	-	-	-	-	00216601	10	-
	CYLINDRE PROFILE européen 5 goupilles à bouton 35 x 35 mm finition laitonée 5 clés réversibles	00093754	10	-	-	-	-	00293754	10	-
	CYLINDRE PROFILE européen 5 goupilles à bouton 40 x 30 mm finition laitonée 5 clés réversibles	00093768	10	-	-	-	-	00216607	10	-
	CYLINDRE PROFILE européen 5 goupilles à bouton 40 x 40 mm finition laitonée 5 clés réversibles	00093756	10	-	-	-	-	00293756	10	-
	CYLINDRE PROFILE européen 5 goupilles à bouton 50 x 30 mm finition laitonée 5 clés réversibles	00093762	10	-	-	-	-	00293762	10	-
	CYLINDRE PROFILE européen 5 goupilles à bouton 50 x 45 mm finition laitonée 5 clés réversibles	00093769	10	-	-	-	-	00216608	10	-
	CYLINDRE PROFILE européen 5 goupilles à bouton 60 x 30 mm finition laitonée 5 clés réversibles	00093765	10	-	-	-	-	00293765	10	-
	CYLINDRE PROFILE européen 5 goupilles à bouton 45 x 35 mm finition laitonée 5 clés réversibles	00093760	10	-	-	-	-	00293760	10	-
	CYLINDRE PROFILE européen 5 goupilles à bouton 45 x 50 mm finition laitonée 5 clés réversibles	00093797	10	-	-	-	-	00293797	10	-
	COQUE de 2 CYLINDRES PROFILE européen 5 goupilles 30 x 30 mm finition laitonée 10 clés réversibles s'entrouvrant	-	-	-	-	-	-	00226602	10	-

CYLINDRE DE SURETÉ

	DEMI-CYLINDRE PROFILE européen 5 goupilles 30x10 finition nickelée 5 clés réversibles	00016616	10	-	-	-	-	00216616	10	-
	CYLINDRE PROFILE européen 5 goupilles 30 x 30 mm finition nickelée 5 clés réversibles	00016617	10	-	-	-	-	00216617	10	-
	CYLINDRE PROFILE européen 5 goupilles 35 x 35 mm finition nickelée 5 clés réversibles	00016621	10	-	-	-	-	00216621	10	-
	CYLINDRE PROFILE européen 5 goupilles 40 x 40 mm finition nickelée 5 clés réversibles	00016622	10	-	-	-	-	00216622	10	-
	CYLINDRE PROFILE européen 5 goupilles 30 x 40 mm finition nickelée 5 clés réversibles	00016618	10	-	-	-	-	00216618	10	-
	CYLINDRE PROFILE européen 5 goupilles 30 x 50 mm finition nickelée 5 clés réversibles	00016619	10	-	-	-	-	00216619	10	-
	CYLINDRE PROFILE européen 5 goupilles 30 x 60 mm finition nickelée 5 clés réversibles	00016620	10	-	-	-	-	00216620	10	-
	CYLINDRE PROFILE européen 5 goupilles 35 x 45 mm finition nickelée 5 clés réversibles	00016623	10	-	-	-	-	00216623	10	-
	CYLINDRE PROFILE européen 5 goupilles 45 x 50 mm finition nickelée 5 clés réversibles	00016624	10	-	-	-	-	00216624	10	-
	CYLINDRE PROFILE européen 5 goupilles à bouton 30 x 30 mm finition nickelée 5 clés réversibles	00016625	10	-	-	-	-	00216625	10	-
	CYLINDRE PROFILE européen 5 goupilles à bouton 35 x 35 mm finition nickelée 5 clés réversibles	00093755	10	-	-	-	-	00293755	10	-

Attention : tous les produits sont livrés en recharge de bac de présentation
Pour fournir le bac, saisir SX + le code produit dans le dépôt 55

Visuel	Designation	Boite	Colis.	Prix	Sachet	Colis.	Prix	Brochable	Colis.	Prix
	CYLINDRE PROFILE européen 5 goupilles à bouton 40 x 40 mm finition nickelée 5 clés réversibles	00093757	10	-	-	-	-	00293757	10	-
	CYLINDRE PROFILE européen 5 goupilles à bouton 30 x 40 mm finition nickelée 5 clés réversibles	00016626	10	-	-	-	-	00216626	10	-
	CYLINDRE PROFILE européen 5 goupilles à bouton 40 x 30 mm finition nickelée 5 clés réversibles	00016653	10	-	-	-	-	-	-	-
	CYLINDRE PROFILE européen 5 goupilles à bouton 40 x 50 mm finition nickelée 5 clés réversibles	-	-	-	-	-	-	00216654	10	-
	CYLINDRE PROFILE européen 5 goupilles à bouton 45 x 45 mm finition nickelée 5 clés réversibles	-	-	-	-	-	-	00216655	10	-
	CYLINDRE PROFILE européen 5 goupilles à bouton 45 x 50 mm finition nickelée 5 clés réversibles	00093796	10	-	-	-	-	00293796	10	-
	CYLINDRE PROFILE européen 5 goupilles à bouton 50 x 30 mm finition nickelée 5 clés réversibles	00093764	10	-	-	-	-	00293764	10	-
	CYLINDRE PROFILE européen 5 goupilles à bouton 60 x 30 mm finition nickelée 5 clés réversibles	00093767	10	-	-	-	-	00293767	10	-
	CYLINDRE PROFILE européen 5 goupilles à bouton 45 x 35 mm finition nickelée 5 clés réversibles	00093761	10	-	-	-	-	00293761	10	-

SERRURE À ENCASTRER

	SERRURE A ENCASTER bec de cane réversible Z/BR	-	-	-	00924010	30	-	00424010	30	-
	SERRURE A ENCASTER à condamnation réversible Z/BR	-	-	-	00924011	30	-	00424011	30	-
	SERRURE A ENCASTER pêne dormant 1/2 tour réversible Z/BR 1 clé	-	-	-	00924012	30	-	00424012	30	-
	SERRURE A ENCASTER pêne dormant 2 tours réversible Z/BR 2 clés	-	-	-	00924015	30	-	00424015	30	-
	BOITIER DE SERRURE à cylindre réversible Z/BR	-	-	-	00924016	30	-	00424016	30	-
	BOITIER DE SERRURE à cylindre 2 tours réversible Z/BR	-	-	-	00951096	30	-	-	-	-

SERRURE À ENCASTRER

	BOITIER DE SERRURE à cylindre 2 tours réversible Z/BR	-	-	-	00951496	30	-	00451496	30	-
---	---	---	---	---	----------	----	---	----------	----	---

SERRURE EN APPLIQUE

	SERRURE pêne dormant 140 x 80 mm droite 1 clé	-	-	-	00904117	10	-	00504117	5	-
	SERRURE pêne dormant 140 x 80 mm gauche 1 clé	-	-	-	00904127	10	-	00504127	5	-
	SERRURE bec de cane 80 x 70 mm	-	-	-	00901109	10	-	-	-	-
	SERRURE pêne dormant 1/2 tour 140 x 80 mm droite 2 clés	-	-	-	00901111	10	-	-	-	-
	SERRURE pêne dormant 1/2 tour 140 x 80 mm gauche 2 clés	-	-	-	00901121	10	-	-	-	-

SERRURE EN APPLIQUE

	SERRURE pêne dormant 1/2 tour 70 x 110 mm droite 2 clés	-	-	-	00901137	10	-	-	-	-
	SERRURE pêne dormant 1/2 tour 70 x 110 mm gauche 2 clés	-	-	-	00901147	10	-	-	-	-

BAC DE PRÉSENTATION

	BB0 Long.(B) 255 x Larg.(A) 100 x Haut.(C) 160 mm	00083924	-	-	-	-	-	-	-	-
	BB 1 Long.(B) 350 x Larg.(A) 125 x Haut.(C) 195 mm	00083614	-	-	-	-	-	-	-	-
	BB2 Long.(B) 400 x Larg.(A) 200 x Haut.(C) 200 mm	00083615	-	-	-	-	-	-	-	-
	BB3 Long.(B) 400 x Larg.(A) 255 x Haut.(C) 195 mm	00083616	-	-	-	-	-	-	-	-
	BB4 Long.(B) 560 x Larg.(A) 325 x Haut.(C) 250 mm	00081925	-	-	-	-	-	-	-	-

Attention : tous les produits sont livrés en recharge de bac de présentation
Pour fournir le bac, saisir SX + le code produit dans le dépôt 55

Tarif clés de rechange / ÉBAUCHES ET CLÉS TAILLÉES

Pour cadenas

	GENCOD		Désignation		PRIX EURO	
	Ébauche	Clé taille			ébauche.	Clé taillée
	00080001	00080011	Ébauche / Clé laiton nickelé MACH 1 20 mm - 25	M	-	-
	00080003	00080013	Ébauche / Clé laiton nickelé MACH 1 30 mm - 35 mm	M	-	-
	00080006	00080016	Ébauche / Clé laiton nickelé MACH 1 40 - 45 mm	M	-	-
	00080005	00080015	Ébauche / Clé laiton nickelé MACH 1 50 mm - 60 mm - 70 mm	M	-	-
	00063010	00063110	Ébauche / Clé acier nickelé MACH 2 25 mm	N	-	-
	00063029	00063120	Ébauche / Clé acier nickelé MACH 2 35 mm	N	-	-
	00063021	00063121	Ébauche / Clé acier nickelé MACH 2 45 - 55 mm	N	-	-
	-	00063114	Clé laiton MACH 2 20 mm	N	-	-
	00063022	00063122	Ébauche / Clé laiton MACH 2 25 mm	N	-	-
	00063023	00063123	Ébauche / Clé laiton MACH 2 35 mm / NAUTIC 35 - 45 mm	N	-	-
	00063024	00063124	Ébauche / Clé laiton nickelé MACH 2 45 - 55 mm	N	-	-
	00063029	00063120	Ébauche / Clé laiton nickelé MACH 3 30 - 35 mm	N	-	-
	00056017	00056117	Ébauche / Clé laiton nickelé MACH 3 40-45-50-55-60mm	N	-	-
	00097091	00097011	Ébauche / Clé laiton nickelé TRANSIT	N	-	-
	-	00049009	Clé laiton nickelé ADRIATIC	C	-	-
	00098001	00098091	Ébauche / Clé laiton nickelé MACH COLOR vert	M	-	-
	00098002	00098092	Ébauche / Clé laiton nickelé MACH COLOR rouge	M	-	-
	00098003	00098093	Ébauche / Clé laiton nickelé MACH COLOR bleu	M	-	-
	00098004	00098094	Ébauche / Clé laiton nickelé MACH COLOR noir	M	-	-
	00098005	00098095	Ébauche / Clé laiton nickelé MACH COLOR jaune	M	-	-

N : sur numéro • M : sur clé modèle • C : sur carte de propriété
Pour composer le Gencod complet, faire précéder le code inscrit par 315026

 Non stocké/Non-stored/Producto no estocado -  Sur stock Europe Zone 1 et Zone 2, nous consulter pour délai d'approvisionnement -  Epuisement/Stock depletion/Agotamiento del stock

Tarif clés de rechange / ÉBAUCHES ET CLÉS TAILLÉES

Pour cadenas

	GENCOD				PRIX EURO	
	Ébauche	Clé taille	Désignation		ébauche.	Clé taillée
	00063025	00063125	Ébauche / Clé laiton SM 355 - 455 - 555	N	-	-
	00063026	00063126	Ébauche / Clé laiton SM 356 - 456 - 556	N	-	-
	00068001	00068002	Ébauche / Clé laiton NAUTIC 55 - 65 - 80 mm	N	-	-
	00056017	00056117	Ébauche / Clé acier nickelé NAUTIC HG	N	-	-
	00088001	00088011	Ébauche / Clé laiton nickelé LAND 60 - 70 - 90 mm	M	-	-
	00096000	00096001	Ébauche / Clé laiton nickelé LAND BLINDE 80mm - MARINOX 50 - MARINOX 60	M	-	-
	00096010	00096011	Ébauche / Clé laiton nickelé MARINOX 40	M	-	-
	00090001	00090011	Ébauche / Clé laiton nickelé SEA LINE	M	-	-
	00092001	00092011	Ébauche / Clé laiton nickelé ASTRA	M	-	-
	-	00033001	Clé acier nickelé 33	N	-	-
	-	00036001	Clé laiton 36 H 42 - 52 mm	N	-	-
	00060110	00060009	Ébauche / Clé MUL-T-LOCK	C	-	-
	00096012	00096013	Ébauche / Clé laiton SP 90 AS	M	-	-
	00096002	00096003	Ébauche / Clé laiton 90 AS - 200 R - 300 R - 300 PR - 900 R - 510 - 520 - 530	N	-	-
	00096009	00096019	Ébauche / Clé laiton nickelé 710 - 720 - 730	N	-	-
	00080006	00096016	Ébauche / Clé laiton nickelé FTH 40 P 40 mm	M	-	-
	00080005	00096017	Ébauche / Clé laiton nickelé FTH 50 P 50 mm	M	-	-
	00096008	00096018	Ébauche / Clé laiton nickelé FTH 802 - 803 - 804 mm	M	-	-
	-	00010000	Clé triangle pour cadenas artillerie	N	-	-
	-	00010001	Clé demi-lune pour cadenas artillerie	N	-	-
	-	00010002	Clé carré pour cadenas artillerie	N	-	-
	00090002	00090012	Ébauche / Clé laiton nickelé CADENAS A LAMELLE	M	-	-
	00090003	00090013	Ébauche / Clé laiton nickelé CADENAS ETANCHE	M	-	-
	-	00024931	Clé 2493 / 45 - 55 mm Wpour cadenas de barrière	M	-	-









N : sur numéro • M : sur clé modèle • C : sur carte de propriété

Pour composer le Gencod complet, faire précéder le code inscrit par 315026

 Non stocké/Non-stored/Producto no estocado -  Sur stock Europe Zone 1 et Zone 2, nous consulter pour délai d'approvisionnement -  Epuisement/Stock depletion/Agotamiento del stock

Tarif clés de rechange / ÉBAUCHES ET CLÉS TAILLÉES

Pour cadenas













	GENCOD			PRIX EURO	
	Ébauche	Clé taille	Désignation	ébauche.	Clé taillée
	00082003	-	Ébauche RUCK 15 mm profil D	-	-
	00082004	-	Ébauche RUCK 15 mm profil G	-	-
	00082005	-	Ébauche RUCK 20 mm profil D	-	-
	00082006	-	Ébauche RUCK 20 mm profil G	-	-
	00082007	-	Ébauche RUCK 25 / 30 mm profil D	-	-
	00082008	-	Ébauche RUCK 25 mm profil G	-	-
	00082009	-	Ébauche RUCK 40 / 50 / 60 mm	-	-
	00062051	-	Ébauche ANSE REGLABLE	-	-
	00089040	00089041	Ébauche / Clé THOR	-	-

N : sur numéro • M : sur clé modèle • C : sur carte de propriété
 Pour composer le Gencod complet, faire précéder le code inscrit par 315026

 Non stocké/Non-stored/Producto no estocado -  Sur stock Europe Zone 1 et Zone 2, nous consulter pour délai d'approvisionnement -  Epuisement/Stock depletion/Agotamiento del stock

Tarif clés de rechange / ÉBAUCHES ET CLÉS TAILLÉES

Pour serrure de meubles - Entrebailleurs - Verrous de fenêtre

	GENCOD		Désignation		PRIX EURO	
	Ébauche	Clé taille			ébauche.	Clé taillée
	-	00023101	Clé laiton vieilli SERRURE A PATTES - SERRURE APPLIQUE	N	-	-
	-	00051001	Clé acier SERRURE BIBLIOTHEQUE	N	-	-
	-	00083001	Clé acier SERRURE FACON PARIS	N	-	-
	-	00014401	Clé acier SERRURE 3 GORGES	M	-	-
	00040100	00040101	Ébauche / Clé acier nickelé SERRURE DE SURETE	N	-	-
	00040202	00040212	Ébauche / Clé laiton nickelé SERRURE 002402	M	-	-
	00040222	00040232	Ébauche / Clé laiton nickelé SERRURE 002402 ancien modèle	M	-	-
	00041901	00041911	Ébauche / Clé laiton nickelé SERRURE VITRINE	M	-	-
	00060401	00060411	Ébauche / Clé laiton nickelé ENTREBAILLEUR FENETRE SERRURE CREMON	M	-	-
	-	00041301	Clé VERROU A LARDER FENETRE	N	-	-
	00041400	00041401	Ébauche / Clé nickelé VERROU FENETRE 414 - 421	M	-	-
	00041500	00041501	Ébauche / Clé nickelé VERROU FENETRE 415	M	-	-
	-	00041601	Clé nickelé VERROU FENETRE 416 - 417	N	-	-

COMMANDE DE CLES DE RECHANGE

Les clés référencées avec repère N peuvent être commandées d'après le numéro gravé sur l'original. Les clés référencées avec repère M ne peuvent être reproduites qu'à partir d'une clé modèle (à nous faire parvenir).

Les clés référencées avec repère C ne peuvent être commandées qu'avec l'original de la carte de propriété fournie avec le cylindre et verrou.

PORT ET EMBALLAGE

Jusqu'à 24 clés, facturation pour port : 6,75 € et emballage : 1,12 € sauf CORSE.

*N : sur numéro • M : sur clé modèle • C : sur carte de propriété
Pour composer le Gencod complet, faire précéder le code inscrit par 315026*







 Non stocké/Non-stored/Producto no estocado -  Sur stock Europe Zone 1 et Zone 2, nous consulter pour délai d'approvisionnement -  Epuisement/Stock depletion/Agotamiento del stock

Tarif clés de rechange / ÉBAUCHES ET CLÉS TAILLÉES





Pour verrous de sûreté

	GENCOD		Désignation		PRIX EURO	
	Ébauche	Clé taille			ébauche.	Clé taillée
	00018957	00028957	Ébauche / Clé laiton nickelé VERROU ALOUETTE - CONCORDE - MYSTERE E	M	-	-
	00018956	00028956	Ébauche / Clé laiton nickelé VERROU CLASSIC - ALOUETTE - CONCORDE - MYSTERE W	M	-	-
	00019956	00029956	Ébauche / Clé laiton nickelé VERROU VSPM	M	-	-
	00063016	00063015	Ébauche / Clé acier nickelé VERROU ALOUETTE - CONCORDE - MYSTERE T	N	-	-
	00010301	00010311	Ébauche / Clé laiton nickelé VERROU CORVETTE - APACHE	M	-	-
	00040100	00040101	Ébauche / Clé acier nickelé VERROU MIRAGE - RAFALE - MIRAGE 6	N	-	-

Pour verrous de haute sûreté

	GENCOD		Désignation		PRIX EURO	
	Ébauche	Clé taille			ébauche.	Clé taillée
	00016709	00016708	Ébauche / Clé laiton SURVEYOR - EMERAUDE	N	-	-
	-	00017708	Clé COBRA, COBRA M, COBRA M+	C	-	-
	00097091	00097011	Ébauche / Clé laiton nickelé TRANSIT	N	-	-
	-	00058001	Clé laiton nickelé CYLINDRE PROFILE TRANSIT2	C	-	-
	-	00018708	Clé ARIANE la première	C	-	-
	-	00018709	Clé ARIANE les suivantes	C	-	-

Pour batteuses









	GENCOD		Désignation		PRIX EURO	
	Ébauche	Clé taille			ébauche.	Clé taillée
	00091401	00091411	Ébauche / Clé nickelée BATTEUSE 914 - 915	M	-	-
	00091601	00091611	Ébauche / Clé nickelée BATTEUSE 916 - 920 - 925 - 930	M	-	-
	00030102	00030103	Ébauche / Clé nickelée BATTEUSE PTT	N	-	-
	00016709	00016708	Ébauche / Clé laiton BATTEUSE SURVEYOR	N	-	-

N : sur numéro • M : sur clé modèle • C : sur carte de propriété
Pour composer le Gencod complet, faire précéder le code inscrit par 315026











 Non stocké/Non-stored/Productos no estocados -  Sur stock Europe Zone 1 et Zone 2, nous consulter pour délai d'approvisionnement -  Epuement/Stock depletion/Agotamiento del stock

Tarif clés de rechange / ÉBAUCHES ET CLÉS TAILLÉES

Pour cylindres de sûreté

	GENCOD		Désignation		PRIX EURO	
	Ébauche	Clé taille			ébauche.	Clé taillée
	00059001	00059002	Ébauche / Clé acier nickelé CYLINDRE PROFILE SA	M	-	-
	00059003	00059004	Ébauche / Clé acier nickelé CYLINDREt PROFILE SA 4 goupilles 25x25	M	-	-
	00016001	00016011	Ébauche / Clé laiton nickelé CYLINDRE PROFILE STD BS	M	-	-
	00016003	00016013	Ébauche / Clé laiton nickelé ASTRA CYLINDRE PROFILE STD H	M	-	-
	00056017	00056117	Ébauche / Clé acier nickelé CYLINDRE PROFILE 5G HG	N	-	-
	00056217	00056317	Ébauche / Clé laiton nickelé CYLINDRE PROFILE 5G HG	N	-	-
	00056018	00056118	Ébauche / Clé acier nickelé CYLINDRE PROFILE 6G HG - VERTI -BELUGA CR / CP	N	-	-
	00056218	00056318	Ébauche / Clé laiton nickelé CYLINDRE PROFILE 6G HG	N	-	-
	00018702	00018703	Ébauche / Clé acier nickelé CYLINDRE TIGER 10		-	-
	00062246	-	Ébauche CYLINDRE RIM		-	-

Pour cylindres de haute sûreté

	GENCOD		Désignation		PRIX EURO	
	Ébauche	Clé taille			ébauche.	Clé taillée
	00016709	00016708	Ébauche / Clé laiton SURVEYOR	N	-	-
	-	00017708	Clé COBRA, COBRA M, COBRA M+	C	-	-
	00018795	00018796	Ébauche / Clé laiton nickelé CYLINDRE PROFILE 6G SHG profil droite (G)	M	-	-
	00018798	00018800	Ébauche / Clé laiton nickelé CYLINDRE PROFILE 6G SHG profil gauche (G)	M	-	-
	00018995	00018996	Ébauche / Clé laiton nickelé CYLINDRE PROFILE 6G SHG ©	M	-	-
	00018695	00018696	Ébauche / Clé laiton nickelé CYLINDRE PROFILE 6G SHG (H)	M	-	-
	00018700	00018701	Ébauche / Clé acier nickelé CYLINDRE PROFILE TIGER 6 (AK)	M	-	-
	00017695	00017696	Ébauche / Clé laiton nickelé CYLINDRE PROFILE TRAFIC 6	M	-	-
	-	00017698	Clé laiton nickelé CYLINDRE PROFILE TRAFIC 6 D	N	-	-
	-	00017692	Clé longue laiton nickelé CYLINDRE PROFILE TRAFIC 6 DL	N	-	-

N : sur numéro • M : sur clé modèle • C : sur carte de propriété

Pour composer le Gencod complet, faire précéder le code inscrit par 315026

 Non stocké/Non-stored/Producto no estocado -  Sur stock Europe Zone 1 et Zone 2, nous consulter pour délai d'approvisionnement -  Epuisement/Stock depletion/Agotamiento del stock

Tarif clés de rechange / ÉBAUCHES ET CLÉS TAILLÉES

Pour cylindres de haute sûreté

	GENCOD		Désignation		PRIX EURO	
	Ébauche	Clé taille			ébauche.	Clé taillée
	00097091	00097011	Ébauche / Clé laiton nickelé CYLINDRE PROFILE TRANSIT	C	-	-
	-	00058001	Clé laiton nickelé CYLINDRE PROFILE TRANSIT2	C	-	-
	00019795	00019796	Ébauche / Clé laiton nickelé CYLINDRE PROFILE TRAFIC 12 T	M	-	-
	-	00017694	Clé laiton nickelé CYLINDRE PROFILE TRAFIC 12 K	N	-	-
	-	00019794	Clé longue laiton nickelé CYLINDRE PROFILE TRAFIC 12 KL	N	-	-
	-	00017699	Clé laiton nickelé CYLINDRE PROFILE TRAFIC 12 M	N	-	-
	-	00019792	Clé longue laiton nickelé CYLINDRE PROFILE TRAFIC 12 ML	N	-	-
	-	00013311	Clé maillechort CYLINDRE PROFILE FEDERAL B	C	-	-
	-	00013315	Clé maillechort CYLINDRE PROFILE FEDERAL C	-	-	-
	-	00013316	Clé maillechort CYLINDRE PROFILE FEDERAL D	-	-	-
	-	00013317	Clé maillechort CYLINDRE PROFILE FEDERAL E	-	-	-
	-	00013226	Clé maillechort CYLINDRE PROFILE FEDERAL 2 FC	-	-	-
	00057005	00057015	Ébauche / Clé maillechort TRANSIT EVOLUTION	C	-	-
	00060110	00060009	Ébauche / Clé CYLINDRE PROFILE MULT-LOCK	C	-	-
	00020710	00020720	Ébauche / Clé maillechort ATLANTIC	C	-	-
	-	00030720	Clé maillechort ATLANTIC M	C	-	-
	-	00017718	Clé maillechort COBRA, COBRA M, COBRA M+	C	-	-
	-	00017719	Clé maillechort COBRA 2	C	-	-
	-	00047009	Clé laiton nickelé ADRIA	C	-	-
	-	00049009	Clé laiton nickelé ADRIATIC	C	-	-
	00013732	00013735	Ébauche / Clé maillechort WCYLINDRE FEDERAL S ©	-	-	-







N : sur numéro • M : sur clé modèle • C : sur carte de propriété

Pour composer le Gencod complet, faire précéder le code inscrit par 315026

 Non stocké/Non-stored/Producto no estocado -  Sur stock Europe Zone 1 et Zone 2, nous consulter pour délai d'approvisionnement -  Epuisement/Stock depletion/Agotamiento del stock

















Tarif clés de rechange / ÉBAUCHES ET CLÉS TAILLÉES

Pour cylindres de haute sûreté

	GENCOD		Désignation	PRIX EURO	
	Ébauche	Clé taille		ébauche.	Clé taillée
	00010118		Reproduction CARTE DE PROPRIÉTÉ HG5 +	-	-
	00010169		Reproduction CARTE DE PROPRIÉTÉ TRANSIT 2	-	-
	00010117		Reproduction CARTE DE PROPRIÉTÉ ADRIA	-	-
	00010122		Reproduction CARTE DE PROPRIÉTÉ ADRIATIC	-	-
	00010060		Reproduction CARTE DE PROPRIÉTÉ COBRA 2	-	-
	00010056		Reproduction CARTE DE PROPRIÉTÉ ATLANTIC M	-	-
	00010999		Contrat de protection ORGANIGRAMME	-	-

Tarif clés de rechange / ÉBAUCHES ET CLÉS TAILLÉES

Pour serrures à encastrer











	GENCOD		Désignation		PRIX EURO	
	Ébauche	Clé taille			ébauche.	Clé taillée
	-	00012298	Clé SERRURE A ENCASTRER ECO + pêne dormant ½ tour axe à 40 mm N° 1	N	-	-
	-	00012299	Clé SERRURE A ENCASTRER ECO + pêne dormant ½ tour axe à 40 mm N° 5	N	-	-
	-	00011299	Clé SERRURE A ENCASTRER pêne dormant ½ tour axe à 40 mm SP	N	-	-
	-	10010299	Clé SERRURE A ENCASTRER pêne dormant ½ tour axe à 40 mm N° 1	N	-	-
	-	20010299	Clé SERRURE A ENCASTRER pêne dormant ½ tour axe à 40 mm N° 2	N	-	-
	-	30010299	Clé SERRURE A ENCASTRER pêne dormant ½ tour axe à 40 mm N° 3	N	-	-
	-	40010299	Clé SERRURE A ENCASTRER pêne dormant ½ tour axe à 40 mm N° 4	N	-	-
	-	50010299	Clé SERRURE A ENCASTRER pêne dormant ½ tour axe à 40 mm N° 5	N	-	-
	-	60010299	Clé SERRURE A ENCASTRER pêne dormant ½ tour axe à 40 mm N° 6	N	-	-
	-	00010300	Clé SERRURE A ENCASTRER 3 gorges axe à 40 mm	N	-	-
	-	00020201	Clé nickelée SERRURE A ENCASTRER pêne dormant ½ tour axe à 50 mm	N	-	-
	-	00008670	Clé SERRURE A ENCASTRER MONOMAX pêne dormant ½ tour axe à 50 mm V6	N	-	-
	-	00008671	Clé SERRURE A ENCASTRER MONOMAX pêne dormant ½ tour axe à 50 mm V5	N	-	-
	-	00008673	Clé SERRURE A ENCASTRER MONOMAX pêne dormant ½ tour axe à 50 mm V3	N	-	-
	-	00008674	Clé SERRURE A ENCASTRER MONOMAX pêne dormant ½ tour axe à 50 mm V2	N	-	-
	-	00020300	Clé nickelé SERRURE A ENCASTRER 4 gorges axe à 50 mm	N	-	-
	-	00055500	Clé nickelée SERRURE A ENCASTRER ALSACE pêne dormant ½ tour axe à 55 mm	N	-	-

N : sur numéro • M : sur clé modèle • C : sur carte de propriété
Pour composer le Gencod complet, faire précéder le code inscrit par 315026

 Non stocké/Non-stored/Producto no estocado -  Sur stock Europe Zone 1 et Zone 2, nous consulter pour délai d'approvisionnement -  Epuisement/Stock depletion/Agotamiento del stock

Tarif clés de rechange / ÉBAUCHES ET CLÉS TAILLÉES

Pour serrures à encastrer











	GENCOD		Désignation	N	PRIX EURO	
	Ébauche	Clé taille			ébauche.	Clé taillée
	-	00055501	Clé SERRURE A ENCASTRER ALSACE N° 1	N	-	-
	-	00055502	Clé SERRURE A ENCASTRER ALSACE N° 2	N	-	-
	-	00055503	Clé SERRURE A ENCASTRER ALSACE N° 3	N	-	-
	-	00055504	Clé SERRURE A ENCASTRER ALSACE N° 4	N	-	-
	-	00055505	Clé SERRURE A ENCASTRER ALSACE N° 5	N	-	-
	-	00055506	Clé SERRURE A ENCASTRER ALSACE N° 6	N	-	-
	-	00055507	Clé SERRURE A ENCASTRER ALSACE N° 7	N	-	-
	-	00055508	Clé SERRURE A ENCASTRER ALSACE N° 8	N	-	-
	-	00055509	Clé SERRURE A ENCASTRER ALSACE N° 9	N	-	-
	-	00055512	Clé SERRURE A ENCASTRER ALSACE N° 10	N	-	-

*N : sur numéro • M : sur clé modèle • C : sur carte de propriété
Pour composer le Gencod complet, faire précéder le code inscrit par 315026*

 Non stocké/Non-stored/Producto no estocado -  Sur stock Europe Zone 1 et Zone 2, nous consulter pour délai d'approvisionnement -  Epuisement/Stock depletion/Agotamiento del stock

Tarif clés de rechange / ÉBAUCHES ET CLÉS TAILLÉES

Pour serrures à appliquer



















	GENCOD		Désignation		PRIX EURO	
	Ébauche	Clé taille			ébauche.	Clé taillée
	-	00031171	Clé SERRURE APPLIQUE pêne dormant laqué 80 - 95 - 110 - 160 V2 E	N	-	-
	-	00031172	Clé SERRURE APPLIQUE pêne dormant laqué 80 - 95 - 110 - 160 V3 E	N	-	-
	-	00031173	Clé SERRURE APPLIQUE pêne dormant laqué 80 - 95 - 110 - 160 V4 E	N	-	-
	-	00031174	Clé SERRURE APPLIQUE pêne dormant laqué 80 - 95 - 110 - 160 V5 E	N	-	-
	-	00031175	Clé SERRURE APPLIQUE pêne dormant laqué 80 - 95 - 110 - 160 V6 E	N	-	-
	-	00011199	Clé SERRURE APPLIQUE pêne dormant laqué 80 - 95 - 110 - 160 V1	N	-	-
	-	00011198	Clé SERRURE APPLIQUE pêne dormant laqué 80 - 95 - 110 - 160 V2	N	-	-
	-	00011197	Clé SERRURE APPLIQUE pêne dormant laqué 80 - 95 - 110 - 160 V3	N	-	-
	-	00011196	Clé SERRURE APPLIQUE pêne dormant laqué 80 - 95 - 110 - 160 V4	N	-	-
	-	00011194	Clé SERRURE APPLIQUE pêne dormant laqué 80 - 95 - 110 - 160 V5	N	-	-
	-	00011193	Clé SERRURE APPLIQUE pêne dormant laqué 80 - 95 - 110 - 160 V6	N	-	-

N : sur numéro • M : sur clé modèle • C : sur carte de propriété
Pour composer le Gencod complet, faire précéder le code inscrit par 315026

 Non stocké/Non-stored/Producto no estocado -  Sur stock Europe Zone 1 et Zone 2, nous consulter pour délai d'approvisionnement -  Epuisement/Stock depletion/Agotamiento del stock

Tarif clés de rechange / ÉBAUCHES ET CLÉS TAILLÉES

Pour serrures à appliquer

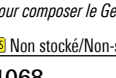
	GENCOD		Désignation	N	PRIX EURO	
	Ébauche	Clé taille			ébauche.	Clé taillée
	-	00011700	Clé SERRURE APPLIQUE pêne dormant laqué 140 GM TETE CARREE V1	N	-	-
	-	00011701	Clé SERRURE APPLIQUE pêne dormant laqué 140 GM TETE CARREE V2	N	-	-
	-	00011702	Clé SERRURE APPLIQUE pêne dormant laqué 140 GM TETE CARREE V3	N	-	-
	-	00011703	Clé SERRURE APPLIQUE pêne dormant laqué 140 GM TETE CARREE V4	N	-	-
	-	00011704	Clé SERRURE APPLIQUE pêne dormant laqué 140 GM TETE CARREE V5	N	-	-
	-	00011705	Clé SERRURE APPLIQUE pêne dormant laqué 140 GM TETE CARREE V6	N	-	-
	-	00011199	Clé SERRURE APPLIQUE pêne dormant ½ tour N° 1	N	-	-
	-	00011198	Clé SERRURE APPLIQUE pêne dormant ½ tour N° 2	N	-	-
	-	00011197	Clé SERRURE APPLIQUE pêne dormant ½ tour N° 3	N	-	-
	-	00011196	Clé SERRURE APPLIQUE pêne dormant ½ tour N° 4	N	-	-
	-	00011194	Clé SERRURE APPLIQUE pêne dormant ½ tour N° 5	N	-	-
	-	00011193	Clé SERRURE APPLIQUE pêne dormant ½ tour N° 6	N	-	-
	-	00011300	Clé SERRURE APPLIQUE HORIZONTALE 4 gorges N° 1A	N	-	-
	-	00011303	Clé SERRURE APPLIQUE HORIZONTALE 4 gorges N° 2A	N	-	-
	-	00011304	Clé SERRURE APPLIQUE HORIZONTALE 4 gorges N° 3A	N	-	-
	-	00011305	Clé SERRURE APPLIQUE HORIZONTALE 4 gorges N° 4A	N	-	-
	-	00011306	Clé SERRURE APPLIQUE HORIZONTALE 4 gorges N° 1E	N	-	-
	-	00011307	Clé SERRURE APPLIQUE HORIZONTALE 4 gorges N° 2E	N	-	-
	-	00011308	Clé SERRURE APPLIQUE HORIZONTALE 4 gorges N° 3E	N	-	-





















N : sur numéro • M : sur clé modèle • C : sur carte de propriété

Pour composer le Gencod complet, faire précéder le code inscrit par 315026

 Non stocké/Non-stored/Producto no estocado -  Sur stock Europe Zone 1 et Zone 2, nous consulter pour délai d'approvisionnement -  Epuisement/Stock depletion/Agotamiento del stock

Tarif clés de rechange / ÉBAUCHES ET CLÉS TAILLÉES

Pour serrures à appliquer

	GENCOD		Désignation		PRIX EURO	
	Ébauche	Clé taille			ébauche.	Clé taillée
	-	00011309	Clé SERRURE APPLIQUE HORIZONTALE 4 gorges N° 4E	N	-	-
	-	00011310	Clé SERRURE APPLIQUE HORIZONTALE 4 gorges N° 1F	N	-	-
	-	00011311	Clé SERRURE APPLIQUE HORIZONTALE 4 gorges N° 2F	N	-	-
	-	00011312	Clé SERRURE APPLIQUE HORIZONTALE 4 gorges N° 3F	N	-	-
	-	00011313	Clé SERRURE APPLIQUE HORIZONTALE 4 gorges N° 4F	N	-	-
	-	00011314	Clé SERRURE APPLIQUE VERTICALE 4 gorges N° 1A	N	-	-
	-	00011315	Clé SERRURE APPLIQUE VERTICALE 4 gorges N° 2A	N	-	-
	-	00011316	Clé SERRURE APPLIQUE VERTICALE 4 gorges N° 3A	N	-	-
	-	00011317	Clé SERRURE APPLIQUE VERTICALE 4 gorges N° 4A	N	-	-
	-	00011318	Clé SERRURE APPLIQUE VERTICALE 4 gorges N° 1E	N	-	-
	-	00011319	Clé SERRURE APPLIQUE VERTICALE 4 gorges N° 2E	N	-	-
	-	00011320	Clé SERRURE APPLIQUE VERTICALE 4 gorges N° 3E	N	-	-
	-	00011321	Clé SERRURE APPLIQUE VERTICALE	N	-	-
	-	00011322	Clé SERRURE APPLIQUE VERTICALE 4 gorges N° 1F	N	-	-
	-	00011323	Clé SERRURE APPLIQUE VERTICALE 4 gorges N° 2F	N	-	-
	-	00011324	Clé SERRURE APPLIQUE VERTICALE 4 gorges N° 3F	N	-	-
	-	00011325	Clé SERRURE APPLIQUE VERTICALE 4 gorges N° 4F	N	-	-
	-	00013800	Clé nickelée SERRURE APPLIQUE 4 gorges plat	N	-	-
	-	00011327	Clé SERRURE APPLIQUE 6 gorges N°214	N	-	-
	-	00011328	Clé SERRURE APPLIQUE 6 gorges N°231	N	-	-



















N : sur numéro • M : sur clé modèle • C : sur carte de propriété

Pour composer le Gencod complet, faire précéder le code inscrit par 315026

 Non stocké/Non-stored/Productos no estocados -  Sur stock Europe Zone 1 et Zone 2, nous consulter pour délai d'approvisionnement -  Epuement/Stock depletion/Agotamiento del stock

Tarif clés de rechange / ÉBAUCHES ET CLÉS TAILLÉES

Pour serrures à appliquer







	GENCOD		Désignation		PRIX EURO	
	Ébauche	Clé taille			ébauche.	Clé taillée
	-	00011329	Clé SERRURE APPLIQUE 6 gorges N°232	N	-	-
	-	00011330	Clé SERRURE APPLIQUE 6 gorges N°234	N	-	-
	-	00011331	Clé SERRURE APPLIQUE 6 gorges N°241	N	-	-
	-	00011332	Clé SERRURE APPLIQUE 6 gorges N°242	N	-	-
	-	00011333	Clé SERRURE APPLIQUE 6 gorges N°243	N	-	-
	-	00011334	Clé SERRURE APPLIQUE 6 gorges N°312	N	-	-
	-	00011335	Clé SERRURE APPLIQUE 6 gorges N°314	N	-	-
	-	00011336	Clé SERRURE APPLIQUE 6 gorges N°321	N	-	-
	-	00011337	Clé SERRURE APPLIQUE 6 gorges N°323	N	-	-
	-	00011338	Clé SERRURE APPLIQUE 6 gorges N°324	N	-	-
	-	00011339	Clé SERRURE APPLIQUE 6 gorges N°342	N	-	-
	-	00011340	Clé SERRURE APPLIQUE 6 gorges N°343	N	-	-
	-	00011341	Clé SERRURE APPLIQUE 6 gorges N°412	N	-	-
	-	00011343	Clé SERRURE APPLIQUE 6 gorges N°413	N	-	-
	-	00011344	Clé SERRURE APPLIQUE 6 gorges N°423	N	-	-
	-	00011345	Clé SERRURE APPLIQUE 6 gorges N°424	N	-	-
	-	00011346	Clé SERRURE APPLIQUE 6 gorges N°432	N	-	-
	-	00011347	Clé SERRURE APPLIQUE 6 gorges N°434	N	-	-

N : sur numéro • M : sur clé modèle • C : sur carte de propriété
 Pour composer le Gencod complet, faire précéder le code inscrit par 315026

 Non stocké/Non-stored/Producto no estocado -  Sur stock Europe Zone 1 et Zone 2, nous consulter pour délai d'approvisionnement -  Epuisement/Stock depletion/Agotamiento del stock

Tarif clés de rechange / ÉBAUCHES ET CLÉS TAILLÉES

Pour cylindres de haute sûreté - Serrures à appliquer

	GENCOD			PRIX EURO		
	Ébauche	Clé taille	Désignation	ébauche.	Clé taillée	
	00056017	00056117	Ébauche / Clé acier nickelé SERRURE APPLIQUE 136 - 146 - 135 - 145 - 1136 - 1146 - 1135 - 1145	N	-	-
	00010301	00010311	Ébauche / Clé acier nickelé SERR. APPLIQUE 114 - 124	M	-	-
	00056017	00056117	Ébauche / Clé acier nickelé SERRURE APPLIQUE 116 - 126 - 115 - 125 - 1116 - 1126 - 1115 - 1125 -	N	-	-
	00050050	00050051	Ébauche / Clé acier nickelé SERRURE ELECTRIQUE TRANSIT EVOLUTION	M	-	-
	00017000	00017001	Ébauche / Clé acier nickelé SERRURE GARAGE 17 - 27 -	M	-	-
	00010301	00010311	Ébauche / Clé acier nickelé SERRURE GARAGE 47 - 57	M	-	-
	00071160	00071161	Ébauche / Clé laiton nickelé SERRURE 907116 / 907126	M	-	-

Diverses

	GENCOD			PRIX EURO		
	Ébauche	Clé taille	Désignation	ébauche.	Clé taillée	
	-	00016210	Ébauche / Clé acier nickelé SERRURE / VERROU TUBULAIRE	M	-	-
	00016211	00016212	Ébauche / Clé acier nickelé SERRURE / VERROU TUBULAIRE - TRS	M	-	-
	00019850	00019851	Ébauche / Clé acier nickelé SERRURE RIDEAU METALLIQUE	M	-	-
	-	00048300	Clé acier nickelé BEQUILLE FENETRE ANODISEE	M	-	-
	-	00014830	Clé acier nickelé BEQUILLE FENETRE LAITON	M	-	-
	-	00069000	Clé acier nickelé BOUTON FENETRE FONTE	M	-	-
	-	00006027	Clé acier nickelé BOUTON et BEQUILLE FENETRE chromé	M	-	-

N : sur numéro • M : sur clé modèle • C : sur carte de propriété
 Pour composer le Gencod complet, faire précéder le code inscrit par 315026

 Non stocké/Non-stored/Productos no estocados -  Sur stock Europe Zone 1 et Zone 2, nous consulter pour délai d'approvisionnement -  Epuïsement/Stock depletion/Agotamiento del stock

Machine à tailler

Designation	Boîte	Colis.	Prix
Machine à tailler			
MACHINE A TAILLER clés	00091002	1	-
MACHINE A TAILLER clés réversibles	00091013	1	-
FORET POUR MACHINE à clés réversibles	00009927	1	-
PALPEUR POUR MACHINE à clés réversibles	00009928	1	-
BROSSE POUR MACHINE à clés	00009959	1	-
FRAISE POUR MACHINE à clés	00009975	1	-

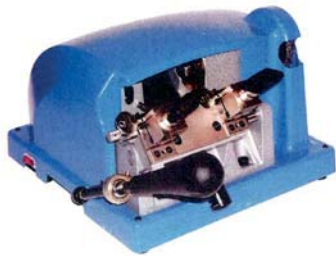

CLÉ UNIQUE *SINGLE KEY* LLAVE ÚNICA

LA CLE UNIQUE DE THIRARD DANS VOS MAGASINS

Le formulaire « clé unique » de THIRARD permet aux clients de construire facilement leur installation pour clé unique et de commander rapidement leur ensemble de sécurité dans votre magasin.

Si vous ne l'avez pas encore, faites nous une demande au plus vite ou bien téléchargez le document directement sur thirard.fr (Formulaire en version papier ou PDF interactif)

Si vous imprimez ce document, veuillez à décocher «mise à l'échelle» (impression sans marge), afin de préserver l'échelle de la règle de mesure du cylindre.

THE THIRARD SINGLE KEY IN YOUR SHOPS

The Thirard «single key» form enables customers to easily build their single key installation and to quickly order their security set in your shop.

If you have not done so already, ask us for one now or download the document direct from thirard.fr (Form available in paper version or interactive pdf)

If you print this document, please deselect "scaling" (no margins), in order to maintain the scale of the cylinder measuring ruler.

LA LLAVE ÚNICA DE THIRARD EN SUS TIENDAS

El formulario "Llave única" de THIRARD permite a los clientes implementar fácilmente la llave única en sus instalaciones y controlar rápidamente toda la seguridad de su tienda.

Si todavía no tiene el formulario, solicitenoslo lo antes posible o descargue el documento directamente en thirard.fr (formulario en papel o PDF interactivo)

Si imprime este documento, desmarque "Ajuste de escala" (impresión sin márgenes) para conservar la escala de la regla de medición del cilindro.



LA CLÉ UNIQUE



SERVEZ-VOUS

La clé unique pour ouvrir toutes vos portes

Porte d'entrée, porte secondaire, portail, grille, boîte aux lettres, porte de garage, cave, cellier, dépendance...

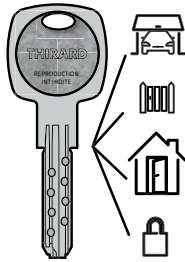

Fini les trousseaux toujours plus encombrants !



*CARTE DE PROPRIÉTÉ :

carte de sécurité fournie à l'achat de votre cylindre et remise au fabricant pour la reproduction de vos clés.

CLÉS RÉVERSIBLES : La clé réversible vous permet d'entrer la clé dans les deux sens pour plus de confort d'usage.

NOMBRE DE CLÉS SOUHAITÉES

Cadre réservé au magasin

N° DE COMMANDE :

Produits sur même N° (1^{ère} commande)
Produits complémentaires sur N°

MAGASIN :

Sécurité TRANSIT 2 • avec carte de propriété et clés réversibles*

CYLINDRE • TRANSIT 2 Pour mesurer votre cylindre, utilisez la règle ci-dessous (3 clés fournies)

Porte (emplacement) <i>Porte d'entrée, porte de chambre...</i>	Cylindre à double	Cylindre à clé et bouton	Cylindre 1/2	Côtes (A X B) de votre cylindre
01				
02				
03				
04				
05				
06				

VERROU • TRANSIT 2

Pour déterminer la longueur du verrou, mesurez l'épaisseur de votre porte et ajoutez 5 mm (pour la garniture) (4 clés fournies)

Porte (emplacement) <i>Porte de cave, porte de garage...</i>	Verrou à double entrée	Verrou à clé et bouton	Dimension du cylindre en mm				
			40	45	50	60	Autre
01							
02							
03							
04							

SERRURE APPLIQUE • Cylindre long. 45 mm - Compatible TRANSIT 2 (4 clés fournies)

Porte (emplacement) <i>Portail, porte de cave, porte de garage...</i>	Sens d'ouverture		Serrure horizontale		Serrure verticale	
	Gauche	Droite	A tirage	A poignée	A tirage	A poignée
01						
02						
03						
04						

CADENAS À CLÉ • Compatible TRANSIT 2 (2 clés fournies)

Local à vélo, abris de jardin, vestiaire...	Cadenas à clé 40 mm	Cadenas à clé 60 mm	Cadenas à clé anse demi-haute 40 mm
	QUANTITÉ :		



MESUREZ la longueur de votre cylindre

A l'aide de la mesure reportez les côtes (A x B) dans le tableau de commande. Aligner le « O » situé au centre de la règle avec l'axe de la vis de fixation du cylindre situé sur la tranche de la porte.

Astuces, conseils, vidéos de pose... www.thirard-astuces.fr

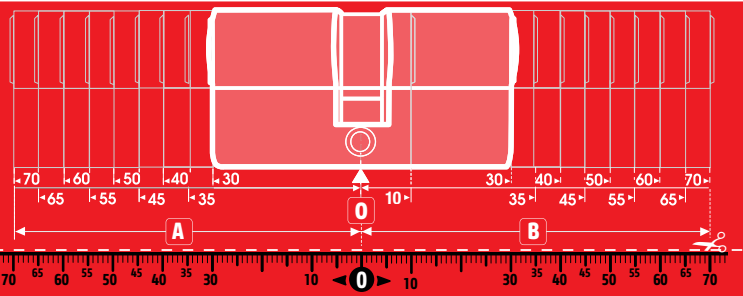

1421 • Communication THIRARD

NORMES ET CERTIFICATIONS *STANDARDS & CERTIFICATIONS* NORMAS Y CERTIFICACIONES

Marquage CE

Depuis le 1^{er} octobre 2003, les produits doivent avoir le marquage CE pour pouvoir circuler librement en Europe. Une obligation impérative pour les produits répondant à une directive européenne.

Le marquage CE s'apparente à une conformité réglementaire. Les produits respectent les exigences abordant les questions de sécurité, de santé publique et de protection des consommateurs.

Les attestations de ce marquage sont délivrées sous la responsabilité de AFNOR Certification.

C'est ainsi que les établissements Thirard doivent répondre au Règlement des Produits de la Construction (RPC 305/2011 du Parlement Européen et du conseil du 9 mars 2011). Les DOP, performances des

produits concernés sont consultables sur www.thirard.fr.

Le marquage CE est facilement identifiable avec l'utilisation du marquage suivant : Sigle CE + N° de l'organisme certificateur.

Un marquage que l'on trouve sur le produit lui-même, sur l'emballage ou sur le document d'accompagnement.

CE marking

Since October 1, 2003, products must carry the CE certification marking in order to circulate throughout Europe. This is a crucial requirement for products that meet this European directive.

The CE marking represents regulatory conformity. These products meet

requirements that address issues of security, public health, and consumer protection.

The certificates given with this marking are overseen by AFNOR certification. Thus, Thirard company must comply with the Construction Products Regulation (Regulation No 305/2011 (Construction Products Regulation) of the European Parliament and of the Council of 9 March 2011). The Declarations of Performance are available at www.thirard.fr.

The CE marking is easily identifiable as used in the following way: CE logo + n° of the certifying body. The marking is found either on the product itself, on the packaging, or within the product's accompanying documents.



Normes et certifications

Marcado CE

Desde el 1 de octubre de 2003, los productos deben tener la marca CE para poder circular libremente en Europa. Una obligación para los productos que responden a una directiva europea.

La marca CE sigue una conformidad reglamentaria. Los productos respetan las exigencias que tratan los

temas de seguridad, salud pública y protección de los consumidores. Las certificaciones de marca se entregan bajo la responsabilidad de AFNOR certification.

Es de este modo que la sociedad Thirard tiene que responder a la normativa de los productos de la construcción (Regulation No 305/2011 (Construction Products Regulation) of the European

Parliament and of the Council of 9 March 2011).

The Declarations of Performance are available at www.thirard.fr.

La marca CE se identifica fácilmente con la utilización del siguiente marcado: logo CE + n° del organismo que certifica.

Una marca que encontramos en el producto, en el empaque o en el documento que lo acompaña.

La société Thirard est certifiée ISO 9001, ISO 14001 et ISO 45001.

Thirard has been certified ISO 9001, ISO 14001 and ISO 45001.

La sociedad Thirard está certificada en ISO 9001, ISO 14001 y ISO 45001.



Marquage NF 040

Plusieurs catégories pour la marque NF

La marque NF est une certification de produit. Cette marque respecte les normes françaises et européennes. Les normes répondent à des critères de dimensions, de sécurité des personnes, d'endurance et de durabilité, de résistance...

C'est AFNOR Certification qui est chargée de s'assurer de la conformité des produits garantis NF aux normes et aux règlements de la marque. De plus cet organisme indépendant effectue des contrôles sur la qualité de fabrication. A l'heure actuelle, quatre familles de produits font l'objet d'une marque NF 040

(cf. tableau ci-joint) dont les marquages diffèrent.

French Standards marking

Several categories under the NF marking.

The NF marking is a product certification. This mark meets both French and European standards. These standards address criteria such as size, personal safety, endurance and durability, and resistance...

The job of AFNOR Certification is to ensure that products that carry the NF mark conform to their standards and regulations.

Furthermore, this independent body conducts manufacturing quality assurance tests.

Currently, four product groups are subject to the NF marking (see attached table), with different marks attributed to each.

Marca NF

Varias categorías para la marcación NF

La marca NF es una certificación de producto. Esta marca respeta las normas francesas y europeas. Las normas responden a criterios de dimensiones, seguridad de las personas, resistencia y durabilidad...

Es AFNOR Certification el encargado de asegurar la conformidad de los productos garantizados NF con las normas y reglamentos de la marca. Además, este organismo independiente realiza controles a la calidad de fabricación.

En este momento, cuatro familias de productos son objeto de una marca NF (ver el cuadro adjunto) en donde las marcas difieren.

Certifié pour un usage traditionnel

Certifié à l'évacuation des personnes

Certifié au compartimentage en cas d'incendie

Certifié à l'évacuation des personnes et au compartimentage en cas d'incendie

Certified for traditional use

Certified for the evacuation of individuals

Certified for fire-blocking

Certified for evacuation of individuals and fire-blocking

Certificado para un uso tradicional

Certificado para evacuación de personas

Certificado para división en compartimientos en caso de incendio

Certificado para la evacuación de personas y división en compartimientos en caso de incendio

Normes et certifications

Les emballages et les produits NF font l'objet d'une attention particulière. Plusieurs modalités de marquage sont définies.

- Le logo NF doit être conforme à la charte graphique.
- La marque du fabricant doit être mentionnée.
- La référence commerciale du produit doit être indiquée.
- L'appartenance à l'une des quatre familles doit être clairement indiquée.
- Une notice d'instruction, montage et entretien, doit également être jointe au produit.

The packaging used for NF certified products is also carefully monitored. Several marking methods have been defined.

- *The NF logo must conform to graphic standards.*
- *The manufacturer's name must be given.*
- *The product's business reference must be given.*
- *It must be clear that the product belongs to one of the four groups stated above.*
- *Directions for use, installation, and maintenance must be included with the product.*



Los empaques de los productos NF son objeto de una atención particular. Están definidas varias modalidades de marcado.

- El logotipo NF debe ser conforme a la carta gráfica.
- La marca del fabricante debe mencionarse.
- La referencia comercial del producto debe estar indicada.
- La pertenencia a una de las cuatro familias debe estar claramente indicada.
- Una nota de instrucción, montaje y mantenimiento debe estar también adjunta al producto.



Endurance de la fonction demi tour sans effort appliqué. Réalisé, au sein de nos usines, conformément au 6.3.1.1 de la norme NF EN 12209.

Endurance of the latch mechanism without applying stress. Carried out at our factory locations, in accordance with 6.3.1.1 of the NF standard.

Resistencia de la función media vuelta sin esfuerzo aplicado. Realizado en nuestras fábricas, conforme al 6.3.1.1 de la norma NF EN 12209.

Normes et certifications



Certification A2P

Le CNPP (Centre National de Protection et de Prévention) localisé près de Vernon dans l'Eure, est le seul organisme accrédité pour délivrer la certification des produits à la marque A2P. Confrontées depuis plusieurs années à une recrudescence des vols et cambriolages, les compagnies d'assurance incitent leurs clients à installer des systèmes de sécurité efficaces. C'est ainsi que le CNPP délivre également des certifications de Service pour l'installation et la maintenance des systèmes de sécurité dans le domaine de l'incendie et de la malveillance (certifications APSAD et A2P Service). La marque A2P est une marque collective qui répond à une certification reconnue par différentes instances : les compagnies d'assurance, les pouvoirs publics, les utilisateurs et les professionnels de la sécurité. L'obtention de la certification A2P relève d'une démarche volontaire de la part du fabricant. Selon le référentiel H61 consultable sur www.cnpp.com.

Qu'est ce que la certification à la marque A2P ?

La marque A2P est avant tout une certification de produit de sécurité vis-à-vis de la résistance à l'effraction. La marque A2P certifie que les produits auxquels elle est apposée répondent à des spécifications techniques définies et proviennent d'une fabrication dont la qualité est contrôlée.

A quoi correspondent les caractéristiques essentielles certifiées ?

Les caractéristiques essentielles certifiées des serrures de bâtiment, bénéficiant de la marque A2P, résident dans la capacité à résister aux tentatives d'ouverture non autorisée, pendant un temps donné,

aux attaques d'un opérateur utilisant sa force physique et des outils définis (outillage à main, électrique et thermique), mais aussi la capacité de la serrure à résister à des tentatives d'ouverture fine.

A quel endroit se déroulent les tests ?

Les tests se déroulent dans les laboratoires du CNPP. Outre les essais, les fabricants sont assujettis à des audits annuels au sein même de leurs entreprises. Chaque produit fabriqué doit être totalement conforme au modèle ayant fait l'objet de la certification A2P.

A quoi correspondent les différentes étoiles accordées par la certification A2P Serrures de Bâtiment ?

Il existe plusieurs classifications en fonction de la résistance des produits à l'effraction qui sont soumis à des essais de plus en plus strictes. En fonction de leur résistance croissante aux tentatives d'ouverture non autorisée, les serrures, y compris leurs sûretés, seront classés en trois classes : 1, 2 et 3 étoiles, cette résistance étant appréciée selon des critères définis par les règles techniques et les méthodes d'essais.

Comment reconnaît-on un produit qui bénéficie de la certification à la marque A2P ?

La première garantie que le produit est bien un produit certifié A2P, réside dans le fait que chacun des éléments qui le constitue est marqué A2P de façon indélébile. Si un des éléments composant le produit est modifié, la certification A2P est automatiquement perdue. Une étiquette informative, comprenant entre autre le logo A2P et la classification du produit, figure également sur l'emballage du produit en sortie d'usine.

A2P Certification

The CNPP (National Centre for Protection and Prevention), located near Vernon in the department of Eure, is the only accredited organisation authorized to issue A2P product certification. In response to an increase in thefts and break-ins

over the last several years, insurance companies are encouraging clients to install effective security systems. This is why the CNPP also issues Service certifications for the installation and maintenance of security systems related to fire and criminal activity (APSAD and A2P Service certifications). The A2P mark is a collective mark that conforms to a certification recognised by several different types of bodies: insurance companies, public authorities, users, and security professionals. Earning the A2P certification is a process that the manufacturer undertakes voluntarily.

What is the A2P certification?

First and foremost, it is a security product certification related to protection against forced entry. The A2P mark certifies that products to which it is applied meet certain technical specifications and come from a manufacturer whose quality is monitored and controlled.

What do the certified essential features mean?

The essential certified features of building locks that are stamped with the A2P mark lie in their ability to stand up to unauthorised entry attempts over a specific time period, to the attempts of a person attempting to enter a property using their physical force or a list of tools (hand, electrical, or thermal tools), and also in the ability of the lock to stand up to more subtle entry attempts.

Where do the tests take place?

The tests are carried out in CNPP laboratories. In addition to the tests, manufacturers are also subjected to annual audits within their companies. Each manufactured product must be entirely consistent with the model certified by the A2P stamp.

What do the different stars awarded by the A2P Building Locks certification represent?

There are several different classifications related to a product's resistance to break-in attempts when subjected to increasingly rigorous testing. In relation to their increasing ability to stand up to non-authorised entry attempts, the locks, including their

Normes et certifications

security, are classed under three categories: 1, 2, or 3 stars, the resistance having been assessed according to specific criteria determined by technical rules and testing methods.

How can you recognise a product that has received the A2P certification?

The first guarantee that the product is genuinely A2P certified is that each of its components has been permanently stamped with the A2P mark.

If one of the elements is modified, that A2P certification is automatically void. An informative label including, among other things, the A2P logo and the product classification, is also affixed to the product packaging as it leaves the factory.

Certificación A2P

El CNPP (Centro Nacional de Protección y Prevención) ubicado cerca de Vernon en el Eure, es el único



organismo acreditado para entregar la certificación de los productos en la A2P. Enfrentadas desde hace varios años a un recrudecimiento de los asaltos y robos, las compañías de seguro incitan a sus clientes a instalar sistemas de seguridad eficaces. Es así que el CNPP entrega igualmente certificaciones de Servicio por la instalación y el mantenimiento de los sistemas de seguridad en el campo de los incendios y el crimen (certificaciones APSAD y A2P Servicio). La marca A2P es una marca colectiva que responde a una certificación reconocida por diferentes instancias: las compañías de seguros, los poderes públicos, los usuarios y los profesionales de la seguridad. La obtención de la certificación A2P es el resultado de una solicitud voluntaria de parte del fabricante.

¿Qué es la certificación en la marca A2P?

Es antes que todo una certificación de producto de seguridad con respecto a la resistencia a la violación. La marca A2P certifica que los productos en los cuales está puesta responden a especificaciones técnicas definidas y provienen de una fabricación en la que la calidad es controlada.

¿A qué corresponden las características esenciales certificadas?

Las características esenciales certificadas de las cerraduras de edificio, que se benefician de la marca A2P, se basan en la capacidad para resistir, durante un tiempo determinado, a los ataques de un operador utilizando su fuerza física o herramientas definidas (equipo manual, eléctrico y térmico), pero también en la capacidad de la cerradura para resistir a las tentativas de apertura cuidadosa.

¿En qué lugar se llevan a cabo las pruebas?

Las pruebas se realizan en los laboratorios del CNPP. Además de los ensayos, los fabricantes están sujetos a auditorías anuales dentro <http://www.serrurier.com/promotion/serrure.jpg> de sus empresas.

Cada producto fabricado debe ser totalmente conforme con el modelo que ha sido objeto de la certificación A2P.

¿A qué corresponden las diferentes estrellas otorgadas por la certificación A2P Cerraduras de edificio? Existen varias clasificaciones en función de la resistencia de los productos a la fractura que están sujetas a ensayos cada vez más estrictos. En función de su resistencia creciente a las tentativas de apertura no autorizada, las cerraduras, incluyendo sus seguros, serán clasificadas en tres clases: 1, 2 y 3 estrellas, esta resistencia se aprecia según criterios definidos por las reglas técnicas y los métodos de ensayo.

¿Cómo se reconoce un producto que se beneficia de la certificación de la marca A2P?

La primera garantía de que el producto es un producto certificado A2P, está en el hecho de que cada uno de los elementos que lo constituye está marcado A2P de forma indeleble. Si uno de los elementos que compone el producto es modificado, la certificación A2P se pierde automáticamente. Una etiqueta informativa, que consta entre otros del logo A2P y la clasificación del producto, figura también en el empaque del producto al salir de la fábrica.



Normes et certifications

Dans le cadre de ses engagements pour l'environnement, THIRARD généralise peu à peu les labels FSC et Imprim'VERT

Label FSC

Le Forest Stewardship Council (FSC) est un écolabel apposé sur les produits issus de forêts bénéficiant d'une gestion socialement, écologiquement et économiquement responsables.

Le système de certification FSC® répond à des critères satisfaisant aux principes de bonnes pratiques appliqués à la gestion forestière, aux dispositions sur le développement durable tels que définis dans la convention de Rio et aux codes de traçabilité des bois issus de ces forêts, appliquée à l'industrie. Cette certification FSC fait parti du cahier des charges appliqué pour la fabrication de nos emballages Adventures.

FSC label

The Forest Stewardship Council (FSC) is an eco-label affixed to products from forests that are managed in a socially, environmentally and economically responsible way.

The FSC® certification system meets criteria satisfying the principles of good practice applied to the management of forests, to the requirements of sustainable development as defined in the Rio Convention and to the codes for the traceability of wood from these forests, applied to industry. This FSC certification forms part of the the specification for the manufacture of our Adventures packaging.

Etiqueta FSC

La Forest Stewardship Council (FSC) es una etiqueta ecológica utilizada en productos derivados de bosques que han sido gestionados de manera social, ecológica y económicamente responsable.

El sistema de certificación FSC® responde a criterios que cumplen los principios de mejores prácticas aplicados a la gestión forestal y a los dispositivos de desarrollo sostenible según se definen en la Convención de Rio y en los códigos de seguimiento de maderas procedentes de estos bosques para aplicaciones industriales. La certificación FSC forma parte del reglamento aplicable a la fabricación de nuestros embalajes Adventures.



La marque de la
gestion forestière
responsable

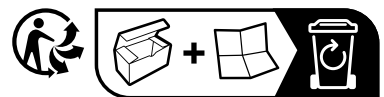
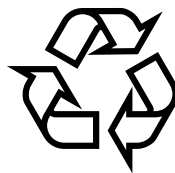

CONDITIONS GÉNÉRALES DE VENTE

Pour toute commande à compter du 01/01/2023

Les présentes conditions générales s'appliquent aux ventes conclues entre la société THIRARD SAS au capital de 182 939 € euros, immatriculée au RCS d'Amiens sous le numéro :

615 780 095 00019, Numéro de TVA intercommunautaire : FR 32 615780095, dont le siège social est situé 45 rue Jean Jaurès – C.S. 60004, 80390 Fressenneville Cedex, France ci-après « Thirard »

et tout acheteur professionnel désirant acquérir les produits. Les présentes conditions générales de vente s'appliquent dans leur intégralité à toutes nos ventes et prestations sans distinction nonobstant toute stipulation, conditions ou documents commerciaux de quelque nature qu'ils soient et notamment les conditions générales d'achat de l'acheteur.

Sauf accord préalable exprès et écrit entre les Parties, le fait de passer commande ou de prendre livraison emporte de plein droit pour l'acheteur l'acceptation sans réserve des présentes conditions et renonciation à l'application de tout document ou convention antérieure, de toute autre clause et condition de quelque nature qu'ils soient et notamment de ses conditions générales d'achats. L'acceptation des présentes conditions générales de vente sans réserve ni exception constitue donc de notre part une cause essentielle et déterminante de notre acceptation et de l'exécution des commandes de l'acheteur.

Les présentes conditions générales de vente constituent le socle de la négociation commerciale tel que défini par les dispositions de l'article L. 441-1 du Code de Commerce. Le résultat de la négociation commerciale qui pourrait s'installer avec l'acheteur devra faire l'objet d'un accord écrit respectant strictement les conditions visées à l'article L. 441-3 du Code de Commerce.

1 - Commandes

1.1 Transmission de commandes et souscription optionnelle de la commande dématérialisée

Les commandes nous sont transmises par mail, fax, portail, ou EDI.

Souscription optionnelle au module de commande du site www.thirard.fr et conditions spécifiques applicables. L'acheteur étant en possession d'un compte client dans la distribution spécialisée peut choisir de souscrire au module de commande de Thirard accessible via le site www.thirard.fr pour une livraison en France métropolitaine, au lieu et place des modalités de commande classiques prévues ci-dessus. La souscription à cette option par l'acheteur lui permet de bénéficier d'un certain nombre de fonctionnalités et de modalités particulières, à savoir :

- l'accès aux stocks Thirard en direct,
- la possibilité de commander les produits à l'unité,
- l'application d'un franco de 75 euros HT.

La souscription de cette option par l'acheteur devra être formalisée dans la convention récapitulative conclue conformément à l'article L.441-3 du Code de commerce pour les relations qui y sont soumises, et en tout état de cause avant toute commande sur le module.

1.2 Modalités de commandes

Les commandes qui nous sont remises ou transmises, même par nos commerciaux, ne deviennent définitives, en ce qui nous concerne, que lorsqu'elles ont fait l'objet d'un accusé de réception par nos soins ou après acceptation tacite résultant de leur enregistrement et de l'émission d'un bon de préparation. Il appartient à l'acheteur de vérifier les spécificités, quantités et dimensions des produits

qu'il commande ainsi que leur désignation et référence. En cas de litige, seule la référence figurant sur la commande sera prise en compte et fera foi entre les parties. Toute annulation de commande qu'elle soit totale ou partielle, et toute demande de modification, qui devront être faites uniquement par courrier, fax ou mail à l'exclusion de tout autre moyen notamment le téléphone, sans accord préalable et exprès de notre part entraînera la facturation pure et simple de la contre-valeur de la commande initiale à titre de dommages et intérêts.

Toute commande de produits devant faire l'objet d'une fabrication spéciale ne pourra en aucun cas être annulée ou modifiée et entraînera sa facturation pure et simple de sa contre-valeur, à titre de dommages et intérêts, même en cas de refus de prendre livraison par l'acheteur. L'acceptation des commandes pourra être subordonnée à un minimum de produits ou au paiement anticipé de tout ou partie de la commande. Nous nous réservons la possibilité de refuser toute commande présentant un caractère anormal ou qui traduirait une demande hors de proportion avec les besoins ou les capacités financières de l'acheteur.

En cas d'absence de prévisionnel de commandes convenu avec l'acheteur et/ou d'augmentation de plus de 20% des commandes par rapport aux commandes passées par l'acheteur le même mois l'année précédente, Thirard ne pourra pas être tenu au taux de services figurant notamment au sein de la convention récapitulative, et ne pourra ainsi se voir imputer des pénalités. L'acheteur nous reconnaît le droit d'apporter à nos produits ainsi qu'à nos prestations toutes modifications que nous jugerions opportunes, ou qui seraient justifiées par les nécessités de la production, sans obligation d'appliquer ces modifications aux produits livrés ou en commande. Lorsque l'acheteur ne peut justifier d'un crédit suffisant ou

que son crédit se détériore, en cas de procédures collectives ou similaires comme en cas d'incident de paiement, nous nous réservons le droit soit d'exiger le paiement anticipé total ou partiel notamment par virement bancaire au moment de la commande, avant sortie d'usine, ou après une livraison partielle. A défaut, nous nous réservons le droit d'annuler tout ou partie des commandes en cours sans que l'acheteur puisse se prévaloir d'un quelconque préjudice.

2 – Normes

Nos produits sont conformes aux normes européennes en vigueur. Sauf exigences particulières mentionnées expressément lors des commandes ou lors de l'acceptation de nos devis, les tolérances en usage dans la profession s'appliquent à nos produits et prestations.

Notre catalogue, qui seul fait foi, décrit plus précisément les spécificités, caractéristiques techniques de fabrication et d'utilisation de nos produits. Nous pourrions apporter des modifications ou améliorations aux informations telles que poids, conditionnement, figurant sur les catalogues et autres documents, lesquels ont valeur indicative, et supprimer des références notamment pour arrêt de fabrication, ou remplacer des références le cas échéant. L'acheteur reconnaît que le fabricant/fournisseur des produits peut arrêter certaines références/modèles ou certaines prestations pour des raisons légitimes. Nous nous engageons à en informer l'acheteur dans un délai raisonnable. L'acheteur ne pourra engager notre responsabilité à ce titre.

L'acheteur s'engage à nous faire connaître dans les plus brefs délais les problèmes de toute nature (incidents, accidents, réclamations...) à raison entre autres de la mise en œuvre ou de l'utilisation des produits.

3 – Prix

Les prix correspondent au tarif et aux conditions en vigueur au jour de la commande, incluant les frais de livraison entrepôt ou magasin selon le tarif joint (le montant du franco dépendant que l'acheteur ait souscrit ou non au module optionnel de commande dématérialisée) et s'entendent hors taxes, hors frais d'emballage et de transfert. Les taxes éventuellement applicables seront celles en vigueur au jour de leur exigibilité.

Pour les commandes de cylindres sur fabrication spéciale à l'unité (sur numéro imposé ou s'entrouvrant) des frais de dossier de 20 euros HT seront ajoutés au prix tarif.

En passant commande, l'acheteur reconnaît avoir eu connaissance de ce tarif qu'il peut également consulter sur notre site Internet www.thirard.fr ou qui pourra lui avoir été communiqué par tout moyen (circulaire, catalogue, publicité, courrier, fax, mail, téléphone...).

En cas de contestation, il lui appartiendra de prouver que nous nous sommes refusés à les lui communiquer. Le cas échéant, et en vertu de l'article 1117 du Code Civil, les prix ne sont valables que pour la durée précisée dans l'offre commerciale, la confirmation de la commande ou les conditions particulières éventuellement conclues avec l'acheteur, ou, à défaut, à l'issue d'un délai raisonnable.

À défaut de délai spécifié par nos soins, le « délai fixé » au sens de cet article sera un délai d'un mois. Au-delà de ce délai fixé, le prix pourra faire l'objet d'une réactualisation, tenant compte de l'évolution des coûts de revient. En cas de variations des données économiques, nous nous réservons le droit de réviser nos prix avec un préavis minimal de deux (2) mois, l'acheteur étant en droit de refuser cette modification et d'annuler sa commande, dans les 48 heures de la notification du nouveau prix, sans frais à sa charge et sans qu'il

puisse réclamer une indemnisation quelconque.

4 - Conditions de paiement

Les factures sont payables par virement, chèque ou espèces à notre siège social quels que soient le lieu et le mode de livraison. Elles sont payables sauf convention contraire à 30 jours à compter de la date d'émission de la facture) Un escompte de 0.45 % sera accordé en cas de paiement dans les dix jours de l'envoi de la facture. Aucune compensation n'est autorisée même entre créances fongibles, certaines, liquides et exigibles, sauf accord de notre part.

Dans le cas de produits spécifiques, nous pourrions demander un acompte de 30% minimum payable à la commande.

Tout retard de paiement entraînera de plein droit, sans qu'un rappel ne soit nécessaire dès le lendemain de l'échéance fixée, le paiement de pénalités de retard dont le montant sera déterminé par l'application du taux de refinancement de la Banque Centrale Européenne majoré de dix points sur les sommes restant dues par l'acheteur, sans préjudice de tous autres dommages et intérêts.

Pour chaque facture totalement ou partiellement impayée, une indemnité forfaitaire de 40 euros sera également appliquée pour frais de recouvrement. Lorsque les frais de recouvrement exposés sont supérieurs au montant de cette indemnité forfaitaire, nous pourrions demander une indemnisation complémentaire à l'acheteur sur justification.

Le défaut de paiement d'une seule facture à l'échéance rend immédiatement exigible, de plein droit et sans mise en demeure, le paiement de toutes les autres factures, même si elles font l'objet de traites en circulation ainsi que celui de toutes les commandes même en cours d'exécution.

Nous pourrions également exiger le paiement immédiat de toute nouvelle commande.

En cas de paiement par traites, celles-ci doivent être retournées et acceptées sous huitaine de leur expédition. A défaut, nous nous réservons le droit de suspendre ou d'annuler les ordres en cours sans préjudice de tout autre recours en cas de non-acceptation des traites ou en cas de défaut de règlement à l'échéance.

Dans ce cas, toute somme versée nous restera acquise au besoin à titre de dommages et intérêts complémentaires. Un litige ou une difficulté admise par nous sur une partie des produits ou des prestations ayant fait l'objet d'une facture n'autorise pas l'acheteur à bloquer l'intégralité du prix de cette facture, ni des factures relatives à d'autres commandes. L'acheteur s'oblige au contraire à régler les sommes dues à leur échéance sous déduction, le cas échéant, après notre accord exprès du montant facturé en litige.

Enfin, conformément à l'article L 442-1 du code de commerce, toute pratique de débit ou d'avoir d'office ou unilatérale est interdite. Tout débit d'office constituera un impayé et donnera lieu à l'application des dispositions des présentes conditions générales régissant les retards de paiement.

5 - Délais et conditions de livraison

Les délais de livraison convenus, qu'il s'agisse de ceux figurant sur nos documents ou qu'il s'agisse de ceux précisés dans les documents de l'acheteur, s'ils ont fait l'objet d'une acceptation expresse de notre part, s'entendent toujours pour des produits mis à disposition de l'acheteur dans nos magasins usines ou entrepôts quelles que soient les modalités de transport. La livraison est supposée effectuée soit par enlèvement direct de l'acheteur, soit par simple avis de mise à disposition adressée à l'acheteur, soit par remise des produits à un expéditeur ou à un transporteur. Les délais d'enlèvement par l'acheteur ou

d'expédition s'ajoutent donc à nos délais de livraison.

5.1. Délais

Nous nous efforçons de respecter les délais de livraison de nos produits et d'exécution de nos prestations portés sur les bons de commande et nos confirmations de commande.

En cas de retard, nous en informons l'acheteur immédiatement et lui proposons une nouvelle date de livraison. Dans le cas des produits en stock, l'acheteur pourra annuler sa commande si le retard dépasse de plus d'1 mois la date de livraison initiale. Dans le cas des fabrications spéciales, l'acheteur pourra annuler sa commande si le retard dépasse plus de 2 mois. Thirard et l'acheteur ne pourront être tenus responsables de l'absence ou d'un retard dans l'exécution de tout ou partie du contrat conclu dû à un événement de force majeure ou d'imprévision, si celui-ci remplit les conditions légales pour qualifier la force majeure ou l'imprévision en droit français, et ce, quel que soit le préjudice subi (cf. 5.3 Imprévision et 5.4 Force Majeure).

Le cas de force majeure suspend les obligations nées du contrat pendant toute la durée de son existence. Toutefois, si le cas de force majeure avait une durée d'existence supérieure à soixante (60) jours consécutifs, il ouvrirait droit à la résolution de plein droit du contrat par nos soins ou par l'acheteur huit (8) jours après l'envoi d'une lettre recommandée avec demande d'avis de réception, notifiant cette décision. Par ailleurs, si un changement de circonstances imprévisible lors de la conclusion du contrat rend l'exécution excessivement onéreuse pour une partie, celle-ci peut demander une renégociation du contrat à l'autre partie dans les conditions de l'article 1195 du Code civil.

5.2. Conditions de livraison
Sauf stipulation expresse

contraire, nos ventes et prestations sont conclues départ usine ou prises en nos usines et nos produits voyagent toujours aux frais, risques et périls de l'acheteur ou du donneur d'ordres quel que soit le moyen de transport choisi, nonobstant les dispositions des présentes conditions générales de vente relatives à la réserve de propriété et le mode de paiement du prix du transport.

La responsabilité concernant les produits ou les prestations est donc automatiquement transférée à l'acheteur dès la sortie des produits de nos magasins, usines ou entrepôts, avant chargement. A défaut de demande expresse de l'acheteur, la livraison est réalisée par le moyen de transport de notre choix qui nous a semblé le plus approprié. Les opérations de manutention, les assurances, formalités douanières ou autres sont à la charge de l'acheteur. Nous n'agissons que pour le compte de l'acheteur qu'à ses frais et risques.

Les frais de port, d'emballage et de manutention figurent sur la facture. Les frais occasionnés par les expéditions expressées demandées par l'acheteur restent à sa charge, le coût de ce transport express sera facturé en sus, quelles que soient les conditions par ailleurs convenues.

5.3. Imprévision

Il est convenu que, en cas de changement de circonstances imprévisible lors de la conclusion du contrat rendant l'exécution excessivement onéreuse pour une partie, les parties renégocieront de bonne foi la modification du contrat. Il est convenu, sans que cette liste soit limitative, que sont notamment visés les événements suivants : variation du cours des matières premières, modification des droits de douane, modification du cours des changes, évolution des législations. En cas de refus ou d'échec de la renégociation, les parties pourront convenir de la résolution du contrat, à la date et aux conditions qu'elles

détermineront, ou demander d'un commun accord au juge de procéder à son adaptation. A défaut d'accord dans un délai raisonnable, le juge pourra, à la demande d'une partie, réviser le contrat ou y mettre fin, à la date et aux conditions qu'il fixe, conformément à l'article 1195 du Code civil. THIRARD déclare en conséquence qu'il n'accepte pas par avance le risque de tels changements de circonstances. Aucune stipulation de prix ferme ou autre mention ne saurait être interprétée comme une telle acceptation de ce risque.

5.4. Force Majeure

Aucune des parties au présent contrat ne pourra être tenue pour responsable de son retard ou de sa défaillance à exécuter l'une des obligations à sa charge au titre du contrat si ce retard ou cette défaillance sont l'effet direct ou indirect d'un cas de force majeure. Il y a force majeure lorsqu'un événement échappant au contrôle d'une partie, qui ne pouvait être raisonnablement prévu lors de la conclusion du contrat et dont les effets ne peuvent être évités par des mesures appropriées, empêche l'exécution de son obligation.

Si l'empêchement est temporaire, l'exécution de l'obligation est suspendue, à moins que le retard qui en résulte ne justifie la résolution du contrat. Si la durée de l'empêchement excède un mois, les parties devront se concerter dans les plus brefs délais pour examiner de bonne foi l'évolution du contrat.

Si l'empêchement est définitif, le contrat est résolu de plein droit dans les conditions prévues aux articles 1351 et 1351-1 du Code civil, si bon semble à la partie qui est empêchée.

Sans que cette liste soit limitative, il est expressément convenu que sont notamment considérés comme des cas de force majeure les événements suivants :

- survenance d'un cataclysme naturel,

- tremblement de terre, tempête, incendie, inondation etc.,
 - conflit armé, guerre, attentats,
 - conflit du travail, grève totale ou partielle chez THIRARD ou le Client,
 - conflit du travail, grève totale ou partielle chez les fournisseurs, prestataires de services, transporteurs, postes, services publics, etc.,
 - pandémie
 - injonction impérative des pouvoirs publics (interdiction d'importer, embargo, etc),
 - accidents d'exploitation, bris de machines, explosion,
 - carence de fournisseur
 - interruptions des moyens de communication ou de télécommunication, et tout incident affectant nos systèmes informatiques
 - interruption ou retard des moyens de transport empêchant la circulation, l'exportation et/ ou l'approvisionnement en matières premières, et produits finis ou semi-finis
- Chaque partie informera l'autre partie, sans délai, de la survenance d'un cas de force majeure dont elle aura connaissance et qui, à ses yeux, est de nature à affecter l'exécution du contrat.

5.5. Réception-Réclamation

Lors de la réception de nos expéditions, il appartient à l'acheteur de vérifier qu'il ne manque pas de colis, qu'il n'y a pas de détérioration de produit ou de manquants. Dans le cas contraire, l'acheteur ou le réceptionnaire doit notifier par acte extrajudiciaire ou par lettre recommandée dans les 3 jours non compris les jours fériés qui suivent la réception, toutes réserves ou réclamations motivées au transporteur, sous peine d'exclusion de garantie en cas de détérioration ou de manque. Un double de cette réclamation devra nous être adressé dans le même délai. Nous nous efforcerons de vous aider dans le règlement de tout litige avec le transporteur. Dans le cas où la vente serait

conclue livraison franco, l'acheteur sera tenu de payer les produits mentionnés sur le bon de livraison s'il n'a pas fait les réserves nécessaires auprès de nous et du transporteur dans les conditions du présent article. Aucune réclamation ne sera acceptée en cas de non-régularisation du bon de livraison.

Sans préjudice des dispositions à prendre vis-à-vis du transporteur, les réclamations sur les vices apparents ou sur la non-conformité du produit livré au produit commandé ou au bordereau d'expédition doivent être formulées par écrit dans les huit jours de l'arrivée des produits et, en tout état de cause, avant montage et utilisation.

De même, nous nous réservons toujours la possibilité d'effectuer des livraisons partielles, ce que ne pourra refuser l'acheteur.

5.6. Retour de produits

L'acheteur ne pourra procéder au retour de produits sans notre accord écrit préalable. Un numéro de retour sera attribué et il devra figurer sur le bon de retour accompagnant les produits retournés. Les frais de retour sont toujours à la charge de l'acheteur. Nous nous réservons le droit de refuser le retour de produits lorsque l'une de ces conditions n'est pas respectée par l'acheteur. En cas de reprise de stocks acceptée préalablement et par écrit par nous, celle-ci se fera sur la base de tarification du prix d'achat avec un abattement forfaitaire de 20 % sur tout produit repris. Les produits incomplets ou dégradés ne sont pas pris en compte et ne peuvent donc faire l'objet d'une reprise.

6 - Réserve de propriété

Les produits livrés restent notre propriété sans exception ni réserve jusqu'au paiement effectif, définitif et intégral du prix en principal et accessoires, y compris le cas échéant les intérêts de retard. Les paiements partiels s'imputeront sur les ventes les

plus anciennes.

Toutefois, la responsabilité des produits et de leur conservation est transférée à l'acheteur, conformément à l'article 5.2, dès la sortie des produits de nos magasins, usines ou entrepôts, avant chargement. L'acheteur devra en conséquence, à partir de cette date, assurer les produits contre tous les risques auprès d'une compagnie d'assurance solvable et prévoir au contrat d'assurance que nous serons subrogés dans tous ses droits vis à vis de cette compagnie d'assurance en cas de sinistre. A notre demande, l'acheteur devra justifier auprès de nous de la souscription de cette assurance, sous peine de résolution immédiate de la vente, les sommes déjà versées restant acquises au besoin à titre de dommages et intérêts. L'acheteur veillera à ce que l'identification de nos produits reste toujours possible.

A défaut de paiement à la date d'exigibilité de toute somme due en vertu du contrat de vente, comme en cas d'inexécution de l'un des engagements de l'acheteur, le contrat de vente sera résolu de plein droit, huit jours après une simple mise en demeure par lettre recommandée, restée sans effet et nous pourrons reprendre sans autre formalité les produits. Cette clause s'appliquera immédiatement en cas de procédure collective.

Dans tous les cas, l'acheteur sera redevable de dommages et intérêts et, en tout état de cause, les sommes et acomptes versés nous resteront acquis au besoin à titre de dommages et intérêts complémentaires.

L'acheteur sera tenu de s'opposer par tous les moyens de droit aux prétentions que des tiers pourraient être amenés à faire valoir sur les biens vendus par voie de saisie, confiscation ou procédures équivalentes.

L'acheteur n'est autorisé à revendre ou à utiliser les produits transformés ou non que pour notre compte et nous délègue

dès à présent toute créance à naître de la revente des produits transformés ou non, jusqu'à due concurrence des sommes nous restant dues. Il devra en avertir expressément son client. Nonobstant cette obligation vis à vis de son client, l'acheteur s'oblige à nous régler immédiatement le prix ou le solde du prix dû et, à défaut, de nous faire connaître sans délai les coordonnées de son client pour nous permettre de revendiquer le prix ou le solde du prix des produits revendus.

7 - Garantie

Nous rappelons qu'il appartient à l'acheteur de porter à notre connaissance les contraintes particulières qui pourraient s'appliquer à sa commande. Notre garantie ne pourra être engagée que dans ces conditions : en cas de non-respect par l'acheteur de ses obligations, il devra, au cas où notre responsabilité serait recherchée, nous indemniser de tous les dommages (matériels ou immatériels) qui pourraient être mis à notre charge ainsi que de tous les frais que nous serions amenés à exposer à cette occasion, en ce compris les éventuels frais judiciaires, d'avocat, d'huissier ou de procédure.

Nos produits et prestations bénéficient de la garantie prévue à nos catalogues ou figurant sur les emballages d'origine. Ces documents précisent le cas échéant les durées de disponibilité de pièces détachées concernant chaque produit.

Toute garantie et toute responsabilité sont exclues pour des incidents tenant à des cas de force majeure ou notamment dans les cas suivants :

- l'usure normale du produit,
- mise en œuvre, montage, installation, utilisation, entretien erronés, inadaptés ou non-conformes aux prescriptions qu'aura le cas échéant données THIRARD ou aux règles de l'art d'utilisation,

- le non-respect par le Client, l'utilisateur ou un tiers, des réglementations de sécurité et d'environnement qui leur sont applicables,
- la négligence, le défaut de surveillance,
- le manque de compétence du metteur en œuvre ou de l'utilisateur du produit,
- la modification ou remise en état du produit ou l'adjonction ou l'intégration de pièces ou éléments par le Client, par l'utilisateur ou par un tiers, sans l'agrément écrit et préalable THIRARD,
- les défauts qui résultent en tout ou partie de l'usure normale du produit,
- les détériorations, défauts ou accidents imputables au Client, à l'utilisateur ou à un tiers, une faute commise par le Client en rapport avec l'exécution du contrat,
- les dommages provenant de l'utilisation par le Client, de documents techniques, informations ou données émanant du Client ou imposées par lui,
- un cas de force majeure telle que définie aux présentes conditions générales.

La garantie sera suspendue en cas de non-paiement par le Client d'un des termes de paiement contractuels. La garantie n'est due qu'en cas de vice caché reconnu; l'acheteur ne pourra en demander l'application notamment en cas de défaut de stockage, de défaut d'entretien, d'utilisation anormale, de vandalisme, de non suivi des conditions d'utilisation, d'intervention non conforme à nos prescriptions ainsi qu'aux normes en vigueur ou aux usages professionnels.

Notre garantie se limite au remplacement de la pièce pour laquelle un vice a été établi à l'exclusion de tout autre préjudice direct ou indirect, matériel ou immatériel et ainsi que de tous frais annexes tels que frais de pose et de dépose, peintures et autres travaux.

Pour pouvoir bénéficier de cette garantie, l'acheteur devra nous aviser sans retard afin de nous permettre de procéder aux

constatations nécessaires et le cas échéant d'apporter les remèdes utiles.

A cette fin, il devra notamment nous retourner, franco de port, la pièce ou le produit qu'il prétend défectueux.

8 – Propriété intellectuelle

Nous sommes et restons titulaires de l'ensemble des droits, matériels ou intellectuels, sur tout produit, service, document ou information nous appartenant exclusivement, protégés ou non au titre de la législation sur la propriété intellectuelle, et notamment brevets, marques, dessins ou modèles enregistrés ou non, nom commercial, secrets industriels ou commerciaux, droits d'auteur, droits des producteurs de bases de données, inventions, méthodes et savoir-faire original, bases de données, informations techniques, commerciales ou financières (ci-après les « Droits Intellectuels »). La vente de nos produits n'autorise pas l'acheteur à faire usage de nos Droits Intellectuels. Par conséquent, aucune licence ou cession sur les Droits Intellectuels n'est consentie à l'acheteur par l'achat de nos produits, sauf convention contraire, écrite et préalable.

Les montages d'usine et les outillages destinés à l'exécution des fabrications spéciales ou non restent notre propriété intellectuelle et matérielle même si une participation a été demandée à l'acheteur au moment de la passation de sa commande. Le fait de passer commande vaut expressément et irrévocablement l'acceptation que la présente clause prévaut sur tout autre clause, condition ou stipulation contraire contenus dans les documents de l'acheteur et notamment dans ses conditions générales d'achat.

9 – Présentation à la vente

Conformément à la législation en vigueur, l'acheteur s'engage à présenter de façon claire et visible aux consommateurs ou aux clients

professionnels des offres détaillées qui rendent compte de façon fidèle des caractéristiques qualitatives et quantitatives des produits offerts à la vente, et informent notamment le consommateur ou le client professionnel quant aux dimensions, poids, nature, qualités, ou encore précautions d'emploi spécifiques liées à la nature du produit. Nous nous engageons à fournir à l'acheteur les informations nécessaires sur les produits.

Si le client souhaite les utiliser pour faire sa propre promotion, déconnectée de la présentation et de la promotion du produit lui-même, il devra obtenir une autorisation spécifique préalable et expresse du Fournisseur.

Le Client ne pourra modifier, adapter, traduire, ou faire des adjonctions ou suppressions aux médias, sans l'autorisation expresse et préalable THIRARD. Il s'interdit de supprimer tout symbole ou mention marquant la propriété ou les restrictions d'utilisation des droits, de procéder à une utilisation des médias susceptible de porter atteinte à des droits de tiers, à toute législation ou de constituer une exploitation préjudiciable. Les médias sont susceptibles de faire l'objet d'une facturation. Si le Client demande à THIRARD d'incorporer les médias sur son support, cette prestation fera l'objet d'un devis.

En cas d'arrêt des relations commerciales pour quelque motif que ce soit, le Client s'engage à supprimer immédiatement les médias de ses supports de communication.

10 – Avantages négociés

Conformément aux dispositions légales, l'ensemble des prestations commerciales qui nous sont rendues par nos clients fait l'objet de contrats répondant aux exigences de forme et de fonds qui leur sont applicables.

Nous ne saurons être tenus de procéder au règlement de factures qui ne répondraient pas aux

exigences légales (absence de contrepartie, absence de contrat préalable, service inexistant, service non proportionné, service non encore rendu, ...).

Toute prestation de l'acheteur ne peut donner lieu à réduction de prix.

En cas de livraison par nos soins au client final consommateur, les frais de port supplémentaires vis-à-vis des consommateurs seront déduit du chiffre d'affaires ristournable ou de la base de calcul des rémunérations des services favorisant la commercialisation des produits et des services favorisant la relation commerciale entre nous et l'acheteur. Nous nous réservons le droit de suspendre l'application des réductions de prix ou de refuser les factures de services même rendus, si l'acheteur n'est pas à jour de ses règlements.

11 – Langue, loi applicable et attribution de juridiction

La langue des relations avec l'acheteur, en ce compris les présentes conditions générales de vente, est le français. En cas de traduction des présentes conditions, seule la version française fera foi entre les parties. Le droit français est seul applicable à nos relations à l'exclusion de tout autre système juridique ou convention internationale, et notamment à l'exclusion de la Convention de Vienne sur la vente internationale de marchandises du 11 avril 1980. De convention expresse, seul le Tribunal de Commerce de notre siège social sera compétent pour statuer sur toute contestation relative à l'exécution des présentes même en cas de pluralité de défendeurs, d'appel en garantie, même pour procédure d'urgence ou conservatoire, en référé ou par requête, quelles que soient les stipulations des conditions générales d'achat de l'acheteur. L'émission ou l'acceptation de traite ou de moyen de paiement n'entraîne ni novation, ni dérogation à cette attribution exclusive de compétence.

12 - Emballage facturé sur commande n'atteignant pas le franco

Prix Euro H.T		Prix Euro H.T		Prix Euro H.T	
Pochette	1,23	Carton 20x20x20	1,58	Caisse palette	18,82
		Carton 28x28x20	2,16	Palette 1.20x0.80	22,56
		Carton 60x40x30	4,31	Palette 0.60x0.80	19,03

Clés de rechange / Port et emballage Jusqu'à 24 clés, sauf Corse		Prix Euro H.T	
		Port	7,09
		Emballage	1,18

13 - Port facturé (transporteur)

(*): F: Prix forfaitaire - A (Arrondi) - D (Prix au détail ramené au diviseur)

Pays	Dpt	Destination	Difficulté	Poids réel	1	11	21	31	41	51	61	71	81	91	100	300	700
					10	20	30	40	50	60	70	80	90	99	299	699	1500
					F	F	F	F	F	F	F	F	F	F	A/10 - D/100	A/10 - D/100	A/10 - D/100
AD			Oui		33,93	34,96	37,79	42,90	46,25	50,26	74,11	76,51	79,84	82,14	82,14	73,96	62,10
FR	1	Ain	Oui		27,14	29,69	33,04	36,84	39,48	42,75	63,17	65,26	68,28	69,84	69,84	63,01	52,90
FR	1	Ain	Montagne	Oui	31,23	34,22	37,94	42,39	45,45	49,17	72,88	75,14	78,49	80,46	80,46	72,23	60,79
FR	2	Aisne	Oui		14,22	15,62	17,43	19,12	20,64	22,49	33,17	34,41	35,75	36,59	36,59	33,15	27,79
FR	3	Allier	Oui		24,37	26,71	29,69	33,04	35,55	38,53	56,82	58,89	61,30	62,86	62,86	56,42	47,46
FR	4	Alpes-de-Haute-Provence	Oui		31,15	33,78	37,09	41,36	44,82	48,59	71,51	73,90	76,93	79,23	79,23	71,28	60,22
FR	4	Alpes-de-Haute-Provence	Hte montagne	Oui	35,83	38,89	42,62	47,79	51,57	55,75	82,14	84,95	88,50	91,20	91,20	81,93	69,06
FR	5	Hautes-Alpes	Oui		29,84	32,54	35,83	39,77	43,05	46,55	68,58	71,19	74,11	76,30	76,30	68,49	57,42
FR	5	Hautes-Alpes	Hte montagne	Oui	34,37	37,43	41,15	45,68	49,46	53,57	78,90	81,72	85,25	87,88	87,88	78,94	66,04
FR	6	Alpes-Maritimes	Oui		36,48	39,56	43,28	48,66	52,31	56,78	83,69	86,41	90,18	92,67	92,67	83,64	69,99
FR	6	Alpes-Maritimes	Hte montagne	Oui	42,03	45,53	49,84	55,90	60,12	65,37	96,41	99,22	103,62	106,73	106,73	96,14	80,48
FR	7	Ardèche	Oui		28,61	31,29	34,65	38,53	41,59	44,96	66,28	68,58	71,51	73,70	73,70	66,43	55,92
FR	8	Ardennes	Oui		16,06	17,58	19,69	21,67	23,42	25,55	37,41	38,78	40,45	41,57	41,57	37,37	31,71
FR	9	Ariège	Oui		31,15	33,78	37,09	41,36	44,82	48,59	71,51	73,90	76,93	79,23	79,23	71,28	60,22
FR	9	Ariège	Hte montagne	Oui	35,83	38,89	42,62	47,79	51,57	55,75	82,14	84,95	88,50	91,20	91,20	81,93	69,06
FR	10	Aube	Oui		19,92	21,75	24,14	26,71	28,76	31,29	46,17	47,84	49,92	51,17	51,17	46,27	38,83
FR	11	Aude	Oui		31,15	33,78	37,09	41,36	44,82	48,59	71,51	73,90	76,93	79,23	79,23	71,28	60,22
FR	12	Aveyron	Oui		29,18	31,82	35,03	39,02	42,31	45,53	67,14	69,63	72,88	74,86	74,86	67,23	56,46
FR	13	Bouches-du-Rhône	Oui		34,88	37,88	41,59	46,42	50,11	54,36	79,95	82,76	86,32	88,81	88,81	80,04	67,35
FR	14	Calvados	Oui		18,10	19,69	22,03	24,14	26,19	28,53	42,01	43,68	45,43	46,49	46,49	41,57	35,28
FR	15	Cantal	Oui		28,61	31,29	34,65	38,53	41,59	44,96	66,28	68,58	71,51	73,70	73,70	66,43	55,92
FR	16	Charente	Oui		27,14	29,69	33,04	36,84	39,48	42,75	63,17	65,26	68,28	69,84	69,84	63,01	52,90
FR	17	Charente-Maritime	Oui		30,41	33,21	36,97	41,15	44,21	47,94	70,69	73,18	76,51	78,39	78,39	70,50	59,46
FR	17	Charente-Maritime	Ile	Oui	34,96	38,17	42,54	47,35	51,00	55,09	81,30	84,11	87,99	90,06	90,06	81,00	68,47
FR	18	Cher	Oui		23,42	25,55	28,30	31,52	34,08	36,84	54,40	56,38	58,68	60,24	60,24	54,25	45,39

(*): F: Prix forfaitaire - A (Arrondi) -
D (Prix au détail ramené au diviseur)

Pays	Dpt	Destination	Difficulté	Poids réel	de	11	21	31	41	51	61	71	81	91	100	300	700
					à	10	20	30	40	50	60	70	80	90	99	299	699
					F	F	F	F	F	F	F	F	F	F	A/10 - D/100	A/10 - D/100	A/10 - D/100
FR	19	Corrèze		Oui	27,64	30,36	33,57	37,50	40,35	43,64	64,42	66,81	69,63	71,40	71,40	64,10	53,83
FR	20	Corse		Oui	69,32	75,24	82,31	92,46	99,30	107,91	159,37	164,08	171,46	176,36	176,36	158,70	133,21
FR	21	Côte-d'Or		Oui	24,37	26,71	29,69	33,04	35,55	38,53	56,82	58,89	61,30	62,86	62,86	56,42	47,46
FR	22	Côtes d'Armor		Oui	25,40	27,94	30,95	34,37	36,97	39,97	59,10	61,30	63,60	65,26	65,26	58,77	49,35
FR	22	Côtes d'Armor	Ile	Oui	29,18	31,95	35,55	39,48	42,54	45,96	68,28	70,58	73,18	75,14	75,14	67,54	56,66
FR	23	Creuse		Oui	25,40	27,94	30,95	34,37	36,97	39,97	59,10	61,30	63,60	65,26	65,26	58,77	49,35
FR	24	Dordogne		Oui	27,64	30,36	33,57	37,50	40,35	43,64	64,42	66,81	69,63	71,40	71,40	64,10	53,83
FR	25	Doubs		Oui	25,40	27,94	30,95	34,37	36,97	39,97	59,10	61,30	63,60	65,26	65,26	58,77	49,35
FR	26	Drôme		Oui	28,17	30,95	34,22	37,94	41,02	44,21	65,26	67,77	70,58	72,35	72,35	65,20	54,78
FR	27	Eure		Oui	14,22	15,62	17,43	19,12	20,64	22,49	33,17	34,41	35,75	36,59	36,59	33,15	27,79
FR	28	Eure-et-Loir		Oui	18,10	19,69	22,03	24,14	26,19	28,53	42,01	43,68	45,43	46,49	46,49	41,57	35,28
FR	29	Finistère		Oui	27,64	30,36	33,57	37,50	40,35	43,64	64,42	66,81	69,63	71,40	71,40	64,10	53,83
FR	29	Finistère	Ile	Oui	31,82	34,88	38,74	43,11	46,32	50,11	74,00	76,81	80,27	82,02	82,02	73,81	62,10
FR	30	Gard		Oui	29,84	32,54	35,83	39,77	43,05	46,55	68,58	71,19	74,11	76,30	76,30	68,49	57,42
FR	31	Haute-Garonne		Oui	29,84	32,54	35,83	39,77	43,05	46,55	68,58	71,19	74,11	76,30	76,30	68,49	57,42
FR	32	Gers		Oui	29,84	32,54	35,83	39,77	43,05	46,55	68,58	71,19	74,11	76,30	76,30	68,49	57,42
FR	33	Gironde		Oui	28,17	30,95	34,22	37,94	41,02	44,21	65,26	67,77	70,58	72,35	72,35	65,20	54,78
FR	34	Hérault		Oui	30,57	33,11	36,48	40,64	43,99	47,50	70,05	72,35	75,67	77,67	77,67	69,88	58,93
FR	35	Ille-et-Vilaine		Oui	24,37	26,71	29,69	33,04	35,55	38,53	56,82	58,89	61,30	62,86	62,86	56,42	47,46
FR	36	Indre		Oui	23,42	25,55	28,30	31,52	34,08	36,84	54,40	56,38	58,68	60,24	60,24	54,25	45,39
FR	37	Indre-et-Loire		Oui	21,67	23,57	26,19	29,10	31,29	34,08	50,03	51,78	54,21	55,45	55,45	49,88	41,84
FR	38	Isère		Oui	28,17	30,95	34,22	37,94	41,02	44,21	65,26	67,77	70,58	72,35	72,35	65,20	54,78
FR	38	Isère	Hte montagne	Oui	32,31	35,55	39,18	43,70	47,22	51,00	75,14	78,07	81,20	83,39	83,39	74,89	62,86
FR	39	Jura		Oui	26,35	28,76	31,95	35,68	38,23	41,36	61,30	63,37	66,09	67,77	67,77	60,98	51,23
FR	40	Landes		Oui	29,18	31,82	35,03	39,02	42,31	45,53	67,14	69,63	72,88	74,86	74,86	67,23	56,46
FR	41	Loir-et-Cher		Oui	21,67	23,57	26,19	29,10	31,29	34,08	50,03	51,78	54,21	55,45	55,45	49,88	41,84
FR	42	Loire		Oui	27,14	29,69	33,04	36,84	39,48	42,75	63,17	65,26	68,28	69,84	69,84	63,01	52,90
FR	43	Haute-Loire		Oui	28,17	30,95	34,22	37,94	41,02	44,21	65,26	67,77	70,58	72,35	72,35	65,20	54,78
FR	44	Loire-Atlantique		Oui	25,40	27,94	30,95	34,37	36,97	39,97	59,10	61,30	63,60	65,26	65,26	58,77	49,35
FR	45	Loiret		Oui	19,92	21,75	24,14	26,71	28,76	31,29	46,17	47,84	49,92	51,17	51,17	46,27	38,83
FR	46	Lot		Oui	28,61	31,29	34,65	38,53	41,59	44,96	66,28	68,58	71,51	73,70	73,70	66,43	55,92
FR	47	Lot-et-Garonne		Oui	29,18	31,82	35,03	39,02	42,31	45,53	67,14	69,63	72,88	74,86	74,86	67,23	56,46
FR	48	Lozère		Oui	29,18	31,82	35,03	39,02	42,31	45,53	67,14	69,63	72,88	74,86	74,86	67,23	56,46
FR	49	Maine-et-Loire		Oui	23,42	25,55	28,30	31,52	34,08	36,84	54,40	56,38	58,68	60,24	60,24	54,25	45,39
FR	50	Manche		Oui	19,92	21,75	24,14	26,71	28,76	31,29	46,17	47,84	49,92	51,17	51,17	46,27	38,83
FR	50	Manche	Ile	Oui	23,00	24,96	27,81	30,70	33,11	36,04	53,15	55,05	57,44	58,79	58,79	53,15	44,46

(*) : F: Prix forfaitaire - A (Arrondi) - D (Prix au détail ramené au diviseur)

Pays	Dpt	Destination	Difficulté	Poids réel	de	11	21	31	41	51	61	71	81	91	100	300	700
					à	10	20	30	40	50	60	70	80	90	99	299	699
					F	F	F	F	F	F	F	F	F	F	A/10 - D/100	A/10 - D/100	A/10 - D/100
FR	52	Haute-Marne		Oui	21,67	23,57	26,19	29,10	31,29	34,08	50,03	51,78	54,21	55,45	55,45	49,88	41,84
FR	53	Mayenne		Oui	21,67	23,57	26,19	29,10	31,29	34,08	50,03	51,78	54,21	55,45	55,45	49,88	41,84
FR	54	Meurthe-et-Moselle		Oui	23,42	25,55	28,30	31,52	34,08	36,84	54,40	56,38	58,68	60,24	60,24	54,25	45,39
FR	55	Meuse		Oui	19,92	21,75	24,14	26,71	28,76	31,29	46,17	47,84	49,92	51,17	51,17	46,27	38,83
FR	56	Morbihan		Oui	26,35	28,76	31,95	35,68	38,23	41,36	61,30	63,37	66,09	67,77	67,77	60,98	51,23
FR	56	Morbihan	Ile	Oui	30,36	33,21	36,84	41,02	44,08	47,79	70,58	73,07	76,00	78,07	78,07	70,20	58,93
FR	57	Moselle		Oui	23,42	25,55	28,30	31,52	34,08	36,84	54,40	56,38	58,68	60,24	60,24	54,25	45,39
FR	58	Nièvre		Oui	23,42	25,55	28,30	31,52	34,08	36,84	54,40	56,38	58,68	60,24	60,24	54,25	45,39
FR	59	Nord		Oui	15,91	17,51	19,41	21,46	23,21	25,30	37,10	38,45	40,15	40,96	40,96	37,05	31,31
FR	60	Oise		Oui	12,47	13,72	15,17	16,71	18,10	19,48	28,87	29,69	31,06	31,90	31,90	29,06	24,20
FR	61	Orne		Oui	19,92	21,75	24,14	26,71	28,76	31,29	46,17	47,84	49,92	51,17	51,17	46,27	38,83
FR	62	Pas-de-Calais		Oui	12,47	13,72	15,17	16,71	18,10	19,48	28,87	29,69	31,06	31,90	31,90	29,06	24,20
FR	63	Puy-de-Dôme		Oui	26,35	28,76	31,95	35,68	38,23	41,36	61,30	63,37	66,09	67,77	67,77	60,98	51,23
FR	64	Pyrénées-Atlantiques		Oui	30,57	33,11	36,48	40,64	43,99	47,50	70,05	72,35	75,67	77,67	77,67	69,88	58,93
FR	64	Pyrénées-Atlantiques	Hte montagne	Oui	35,03	38,09	42,03	46,70	50,49	54,73	80,58	83,39	87,04	89,43	89,43	80,37	67,73
FR	65	Hautes-Pyrénées		Oui	30,57	33,11	36,48	40,64	43,99	47,50	70,05	72,35	75,67	77,67	77,67	69,88	58,93
FR	65	Hautes-Pyrénées	Hte montagne	Oui	35,03	38,09	42,03	46,70	50,49	54,73	80,58	83,39	87,04	89,43	89,43	80,37	67,73
FR	66	Pyrénées-Orientales		Oui	32,31	34,96	37,79	42,90	46,25	50,26	74,11	76,51	79,84	82,14	82,14	73,96	62,10
FR	66	Pyrénées-Orientales	Hte montagne	Oui	37,28	40,35	43,55	49,38	53,19	57,86	85,25	87,99	91,83	94,43	94,43	85,06	71,66
FR	67	Bas-Rhin		Oui	25,40	27,94	30,95	34,37	36,97	39,97	59,10	61,30	63,60	65,26	65,26	58,77	49,35
FR	68	Haut-Rhin		Oui	25,40	27,94	30,95	34,37	36,97	39,97	59,10	61,30	63,60	65,26	65,26	58,77	49,35
FR	69	Rhône		Oui	27,14	29,69	33,04	36,84	39,48	42,75	63,17	65,26	68,28	69,84	69,84	63,01	52,90
FR	70	Haute-Saône		Oui	24,37	26,71	29,69	33,04	35,55	38,53	56,82	58,89	61,30	62,86	62,86	56,42	47,46
FR	71	Saône-et-Loire		Oui	26,35	28,76	31,95	35,68	38,23	41,36	61,30	63,37	66,09	67,77	67,77	60,98	51,23
FR	72	Sarthe		Oui	19,92	21,75	24,14	26,71	28,76	31,29	46,17	47,84	49,92	51,17	51,17	46,27	38,83
FR	73	Savoie		Oui	27,64	30,36	33,57	37,50	40,35	43,64	64,42	66,81	69,63	71,40	71,40	64,10	53,83
FR	73	Savoie	Hte montagne	Oui	31,82	34,88	38,74	43,11	46,32	50,11	74,00	76,81	80,27	82,02	82,02	73,81	62,10
FR	74	Haute-Savoie		Oui	27,64	30,36	33,57	37,50	40,35	43,64	64,42	66,81	69,63	71,40	71,40	64,10	53,83
FR	74	Haute-Savoie	Hte montagne	Oui	31,82	34,88	38,74	43,11	46,32	50,11	74,00	76,81	80,27	82,02	82,02	73,81	62,10
FR	75	Paris		Oui	24,39	26,76	29,88	32,77	35,39	38,53	39,78	41,29	42,90	43,89	43,89	39,77	27,79
FR	76	Seine-Maritime		Oui	14,22	15,62	17,43	19,12	20,64	22,49	33,17	34,41	35,75	36,59	36,59	33,15	27,79
FR	77	Seine-et-Marne		Oui	24,39	26,76	29,88	32,77	35,39	38,53	39,78	41,29	42,90	43,89	43,89	39,77	27,79
FR	78	Yvelines		Oui	24,39	26,76	29,88	32,77	35,39	38,53	39,78	41,29	42,90	43,89	43,89	39,77	27,79

(*): F: Prix forfaitaire - A (Arrondi) -
D (Prix au détail ramené au diviseur)

Pays	Dpt	Destination	Difficulté	Poids réel	de													
					1	11	21	31	41	51	61	71	81	91	100	300	700	
					à													
					10	20	30	40	50	60	70	80	90	99	299	699	1500	
					F	F	F	F	F	F	F	F	F	F	A/10 - D/100	A/10 - D/100	A/10 - D/100	
FR	79	Deux-Sèvres		Oui	26,35	28,76	31,95	35,68	38,23	41,36	61,30	63,37	66,09	67,77	67,77	60,98	51,23	
FR	80	Somme		Oui	12,47	13,72	15,17	16,71	18,10	19,48	28,87	29,69	31,06	31,90	31,90	29,06	24,20	
FR	81	Tarn		Oui	29,84	32,54	35,83	39,77	43,05	46,55	68,58	71,19	74,11	76,30	76,30	68,49	57,42	
FR	82	Tarn-et-Garonne		Oui	29,18	31,82	35,03	39,02	42,31	45,53	67,14	69,63	72,88	74,86	74,86	67,23	56,46	
FR	83	Var		Oui	31,82	34,50	37,79	42,31	45,53	49,46	72,97	75,25	78,60	80,98	80,98	73,01	60,96	
FR	84	Vaucluse		Oui	32,90	35,83	39,40	43,78	47,35	51,23	75,48	78,16	81,62	84,02	84,02	75,20	63,60	
FR	85	Vendée		Oui	26,35	28,76	31,95	35,68	38,23	41,36	61,30	63,37	66,09	67,77	67,77	60,98	51,23	
FR	85	Vendée	Ile	Oui	30,36	33,21	36,84	41,02	44,08	47,79	70,58	73,07	76,00	78,07	78,07	70,20	58,93	
FR	86	Vienne		Oui	24,37	26,71	29,69	33,04	35,55	38,53	56,82	58,89	61,30	62,86	62,86	56,42	47,46	
FR	87	Haute-Vienne		Oui	29,10	31,74	35,09	39,18	42,24	45,58	67,56	69,84	72,88	74,63	74,63	67,06	56,28	
FR	88	Vosges		Oui	24,37	26,71	29,69	33,04	35,55	38,53	56,82	58,89	61,30	62,86	62,86	56,42	47,46	
FR	89	Yonne		Oui	19,92	21,75	24,14	26,71	28,76	31,29	46,17	47,84	49,92	51,17	51,17	46,27	38,83	
FR	90	Terr. de Belfort		Oui	26,35	28,76	31,95	35,68	38,23	41,36	61,30	63,37	66,09	67,77	67,77	60,98	51,23	
FR	91	Essonne		Oui	24,39	26,76	29,88	32,77	35,39	38,53	39,78	41,29	42,90	43,89	43,89	39,77	27,79	
FR	92	Hauts-de-Seine		Oui	24,39	26,76	29,88	32,77	35,39	38,53	39,78	41,29	42,90	43,89	43,89	39,77	27,79	
FR	93	Seine-St-Denis		Oui	24,39	26,76	29,88	32,77	35,39	38,53	39,78	41,29	42,90	43,89	43,89	39,77	27,79	
FR	94	Val-de-Marne		Oui	24,39	26,76	29,88	32,77	35,39	38,53	39,78	41,29	42,90	43,89	43,89	39,77	27,79	
FR	95	Val-D'Oise		Oui	24,39	26,76	29,88	32,77	35,39	38,53	39,78	41,29	42,90	43,89	43,89	39,77	27,79	
LU				Oui	21,67	23,57	26,19	29,10	31,29	34,08	50,03	51,78	54,21	55,45	55,45	49,88	41,84	
MC				Oui	36,48	39,56	43,28	48,66	52,31	56,78	83,69	86,41	90,18	92,67	92,67	83,64	69,99	



www.thirard.fr

www.thirardbalcani.ro
www.thirardpolska.pl